

Symbolic Math Toolbox™

User's Guide



MATLAB®

R2020a



How to Contact MathWorks



Latest news: www.mathworks.com
Sales and services: www.mathworks.com/sales_and_services
User community: www.mathworks.com/matlabcentral
Technical support: www.mathworks.com/support/contact_us



Phone: 508-647-7000



The MathWorks, Inc.
1 Apple Hill Drive
Natick, MA 01760-2098

Symbolic Math Toolbox™ User's Guide

© COPYRIGHT 1993–2020 by The MathWorks, Inc.

The software described in this document is furnished under a license agreement. The software may be used or copied only under the terms of the license agreement. No part of this manual may be photocopied or reproduced in any form without prior written consent from The MathWorks, Inc.

FEDERAL ACQUISITION: This provision applies to all acquisitions of the Program and Documentation by, for, or through the federal government of the United States. By accepting delivery of the Program or Documentation, the government hereby agrees that this software or documentation qualifies as commercial computer software or commercial computer software documentation as such terms are used or defined in FAR 12.212, DFARS Part 227.72, and DFARS 252.227-7014. Accordingly, the terms and conditions of this Agreement and only those rights specified in this Agreement, shall pertain to and govern the use, modification, reproduction, release, performance, display, and disclosure of the Program and Documentation by the federal government (or other entity acquiring for or through the federal government) and shall supersede any conflicting contractual terms or conditions. If this License fails to meet the government's needs or is inconsistent in any respect with federal procurement law, the government agrees to return the Program and Documentation, unused, to The MathWorks, Inc.

Trademarks

MATLAB and Simulink are registered trademarks of The MathWorks, Inc. See www.mathworks.com/trademarks for a list of additional trademarks. Other product or brand names may be trademarks or registered trademarks of their respective holders.

Patents

MathWorks products are protected by one or more U.S. patents. Please see www.mathworks.com/patents for more information.

Revision History

August 1993	First printing	
October 1994	Second printing	
May 1997	Third printing	Revised for Version 2
May 2000	Fourth printing	Minor changes
June 2001	Fifth printing	Minor changes
July 2002	Online only	Revised for Version 2.1.3 (Release 13)
October 2002	Online only	Revised for Version 3.0.1
December 2002	Sixth printing	
June 2004	Seventh printing	Revised for Version 3.1 (Release 14)
October 2004	Online only	Revised for Version 3.1.1 (Release 14SP1)
March 2005	Online only	Revised for Version 3.1.2 (Release 14SP2)
September 2005	Online only	Revised for Version 3.1.3 (Release 14SP3)
March 2006	Online only	Revised for Version 3.1.4 (Release 2006a)
September 2006	Online only	Revised for Version 3.1.5 (Release 2006b)
March 2007	Online only	Revised for Version 3.2 (Release 2007a)
September 2007	Online only	Revised for Version 3.2.2 (Release 2007b)
March 2008	Online only	Revised for Version 3.2.3 (Release 2008a)
October 2008	Online only	Revised for Version 5.0 (Release 2008a+)
October 2008	Online only	Revised for Version 5.1 (Release 2008b)
November 2008	Online only	Revised for Version 4.9 (Release 2007b+)
March 2009	Online only	Revised for Version 5.2 (Release 2009a)
September 2009	Online only	Revised for Version 5.3 (Release 2009b)
March 2010	Online only	Revised for Version 5.4 (Release 2010a)
September 2010	Online only	Revised for Version 5.5 (Release 2010b)
April 2011	Online only	Revised for Version 5.6 (Release 2011a)
September 2011	Online only	Revised for Version 5.7 (Release 2011b)
March 2012	Online only	Revised for Version 5.8 (Release 2012a)
September 2012	Online only	Revised for Version 5.9 (Release 2012b)
March 2013	Online only	Revised for Version 5.10 (Release 2013a)
September 2013	Online only	Revised for Version 5.11 (Release 2013b)
March 2014	Online only	Revised for Version 6.0 (Release 2014a)
October 2014	Online only	Revised for Version 6.1 (Release 2014b)
March 2015	Online only	Revised for Version 6.2 (Release 2015a)
September 2015	Online only	Revised for Version 6.3 (Release 2015b)
March 2016	Online only	Revised for Version 7.0 (Release 2016a)
September 2016	Online only	Revised for Version 7.1 (Release 2016b)
March 2017	Online only	Revised for Version 7.2 (Release 2017a)
September 2017	Online only	Revised for Version 8.0 (Release 2017b)
March 2018	Online only	Revised for Version 8.1 (Release 2018a)
September 2018	Online only	Revised for Version 8.2 (Release 2018b)
March 2019	Online only	Revised for Version 8.3 (Release 2019a)
September 2019	Online only	Revised for Version 8.4 (Release 2019b)
March 2020	Online only	Revised for Version 8.5 (Release 2020a)

Getting Started

1

Symbolic Math Toolbox Product Description	1-2
Key Features	1-2
Create Symbolic Numbers, Variables, and Expressions	1-3
Create Symbolic Numbers	1-3
Create Symbolic Variables	1-3
Create Symbolic Expressions	1-5
Reuse Names of Symbolic Objects	1-5
Create Symbolic Functions	1-7
Create Symbolic Matrices	1-9
Use Existing Symbolic Variables	1-9
Generate Elements While Creating a Matrix	1-9
Create Matrix of Symbolic Numbers	1-10
Perform Symbolic Computations	1-11
Differentiate Symbolic Expressions	1-11
Integrate Symbolic Expressions	1-12
Solve Equations	1-13
Simplify Symbolic Expressions	1-15
Substitutions in Symbolic Expressions	1-16
Plot Symbolic Functions	1-18
Use Assumptions on Symbolic Variables	1-24
Default Assumption	1-24
Set Assumptions	1-24
Check Existing Assumptions	1-25
Delete Symbolic Objects and Their Assumptions	1-25

Using Symbolic Math Toolbox Software

2

Find Symbolic Variables in Expressions, Functions, Matrices	2-3
Find a Default Symbolic Variable	2-3
Choose syms or sym Function	2-5
Add Subscripts, Superscripts, and Accents to Symbolic Variables	2-8
Change Output Display Format of Symbolic Results	2-12

Copy and Paste Symbolic Output in Live Editor	2-15
Units of Measurement Tutorial	2-19
Define and Convert Units	2-19
Use Temperature Units in Absolute or Difference Forms	2-20
Verify Dimensions	2-20
Use Units in Differential Equations	2-22
Units and Unit Systems List	2-25
Units List	2-25
SI Unit Prefixes List	2-35
Unit Systems List	2-36
Defining Constants of SI Units	2-37
Unit Conversions and Unit Systems	2-39
Convert Units	2-39
Temperature Unit Conversion	2-40
Convert to SI, CGS, or US Unit Systems	2-40
Define Custom Unit System from Existing System	2-42
Define Custom Unit System Directly	2-43
Unit System Definition	2-44
Differentiation	2-46
Derivatives of Expressions with Several Variables	2-47
More Examples	2-48
Functional Derivatives Tutorial	2-51
Limits	2-56
One-Sided Limits	2-56
Integration	2-59
Integration with Real Parameters	2-61
Integration with Complex Parameters	2-62
High-Precision Numerical Integration Using Variable-Precision Arithmetic	2-63
Symbolic Summation	2-65
Comparing symsum and sum	2-65
Computational Speed of symsum versus sum	2-65
Output Format Differences Between symsum and sum	2-66
Taylor Series	2-67
Padé Approximant	2-69
Find Asymptotes, Critical, and Inflection Points	2-76
Simplify Symbolic Expressions	2-81
Simplify Using Options	2-82
Simplify Using Assumptions	2-84
Simplify Fractions	2-84
Solve Algebraic Equation Using Live Editor Task	2-86

Simplify Symbolic Expressions Using Live Editor Task	2-94
Abbreviate Common Terms in Long Expressions	2-101
Choose Function to Rearrange Expression	2-104
Combine Terms of Same Algebraic Structures	2-104
Expand Expressions	2-105
Factor Expressions	2-106
Extract Subexpressions from Expression	2-108
Collect Terms with Same Powers	2-108
Rewrite Expressions in Terms of Other Functions	2-109
Compute Partial Fraction Decompositions of Expressions	2-110
Compute Normal Forms of Rational Expressions	2-110
Represent Polynomials Using Horner Nested Forms	2-111
Clear Assumptions and Reset the Symbolic Engine	2-112
Check Assumptions Set on Variables	2-113
Effects of Assumptions on Computations	2-114
Extract Numerators and Denominators of Rational Expressions	2-115
Substitute Variables in Symbolic Expressions	2-117
Substitute Elements in Symbolic Matrices	2-119
Substitute Scalars with Matrices	2-121
Evaluate Symbolic Expressions Using subs	2-123
Choose Numeric or Symbolic Arithmetic	2-124
Double-Precision Arithmetic	2-124
Variable-Precision Arithmetic	2-124
Symbolic Arithmetic	2-125
Comparisons of Numeric and Symbolic Arithmetic	2-126
Increase Precision of Numeric Calculations	2-128
Recognize and Avoid Round-Off Errors	2-130
Use Symbolic Computations When Possible	2-130
Perform Calculations with Increased Precision	2-130
Compare Symbolic and Numeric Results	2-132
Plot the Function or Expression	2-132
Increase Speed by Reducing Precision	2-134
Numeric to Symbolic Conversion	2-136
Conversion to Rational Symbolic Form	2-137
Conversion by Using Floating-Point Expansion	2-137
Conversion to Rational Symbolic Form with Error Term	2-137
Conversion to Decimal Form	2-138
Basic Algebraic Operations	2-139
Linear Algebraic Operations	2-141
Symbolic Hilbert Matrix	2-141

Symbolic Linear Algebra Operations	2-141
Variable-Precision Arithmetic	2-142
Symbolic Investigation of Singular Value	2-143
Eigenvalues	2-145
Jordan Canonical Form	2-149
Singular Value Decomposition	2-151
Solve Algebraic Equation	2-153
Solve an Equation	2-153
Return the Full Solution to an Equation	2-153
Work with the Full Solution, Parameters, and Conditions Returned by solve	2-154
Visualize and Plot Solutions Returned by solve	2-155
Simplify Complicated Results and Improve Performance	2-156
Solve a Second-Order Differential Equation Numerically	2-157
Select Numeric or Symbolic Solver	2-159
Solve System of Algebraic Equations	2-160
Handle the Output of solve	2-160
Solve a Linear System of Equations	2-162
Return the Full Solution of a System of Equations	2-162
Solve a System of Equations Under Conditions	2-164
Work with Solutions, Parameters, and Conditions Returned by solve . . .	2-165
Convert Symbolic Results to Numeric Values	2-167
Simplify Complicated Results and Improve Performance	2-168
Troubleshoot Equation Solutions from solve Function	2-169
Return Only Real Solutions	2-169
Apply Simplification Rules	2-169
Use Assumptions to Narrow Results	2-170
Simplify Solutions	2-171
Tips	2-171
Solve System of Linear Equations	2-173
Solve System of Linear Equations Using <code>linsolve</code>	2-173
Solve System of Linear Equations Using <code>solve</code>	2-174
Solve Equations Numerically	2-176
Solve Differential Equation	2-185
First-Order Linear ODE	2-185
Solve Differential Equation with Condition	2-185
Nonlinear Differential Equation with Initial Condition	2-186
Second-Order ODE with Initial Conditions	2-186
Third-Order ODE with Initial Conditions	2-186
More ODE Examples	2-187
Solve a System of Differential Equations	2-189
Solve System of Differential Equations	2-189
Solve Differential Equations in Matrix Form	2-191

Solve Differential Algebraic Equations (DAEs)	2-194
Solve Semilinear DAE System	2-203
Step 1. Reduce Differential Index with reduceDAEToODE	2-203
Step 2. ODEs to Function Handles for ode15s and ode23t	2-203
Step 3. Initial Conditions for ode15s and ode23t	2-204
Step 4. Solve an ODE System with ode15s or ode23t	2-206
Solve DAEs Using Mass Matrix Solvers	2-209
Step 1. Convert DAEs to Function Handles	2-209
Step 2. Find Initial Conditions	2-210
Step 3. Solve DAE System	2-211
Fourier and Inverse Fourier Transforms	2-214
Fourier Transform Definition	2-214
Concept: Using Symbolic Workflows	2-214
Calculate Beam Deflection Using Fourier Transform	2-214
Solve Differential Equations Using Laplace Transform	2-218
Definition: Laplace Transform	2-218
Concept: Using Symbolic Workflows	2-218
Workflow: Solve RLC Circuit Using Laplace Transform	2-218
Solve Difference Equations Using Z-Transform	2-224
Definition: Z-transform	2-224
Concept: Using Symbolic Workflows	2-224
Workflow: Solve "Rabbit Growth" Problem Using Z-Transform	2-224
References	2-228
Create Plots	2-229
Plot with Symbolic Plotting Functions	2-229
Plot Functions Numerically	2-231
Plot Multiple Symbolic Functions in One Graph	2-232
Plot Multiple Symbolic Functions in One Figure	2-233
Combine Symbolic Function Plots and Numeric Data Plots	2-234
Combine Numeric and Symbolic Plots in 3-D	2-236
Plotting in Spherical Coordinate System	2-239
Analytical Solutions of the Inverse Kinematics of a Humanoid Robot	2-241
Analytical Model of Cantilever Truss Structure for Simscape	2-252
Estimate Model Parameters of a Symbolically Derived Plant Model in Simulink	2-260
Generate C or Fortran Code from Symbolic Expressions	2-266
Generate MATLAB Functions from Symbolic Expressions	2-267
Generating a Function Handle	2-267
Control the Order of Variables	2-267
Generate a File	2-268
Name Output Variables	2-269

Generate MATLAB Function Blocks from Symbolic Expressions	2-270
Generate and Edit a Block	2-270
Control the Order of Input Ports	2-270
Name the Output Ports	2-270
Generate Simscape Equations from Symbolic Expressions	2-272
Convert Algebraic and Differential Equations	2-272
Limitations	2-273

MuPAD to MATLAB Migration

3

MuPAD Engines and MATLAB Workspace	3-2
Convert MuPAD Notebooks to MATLAB Live Scripts	3-3
Convert a MuPAD Notebook .mn to a MATLAB Live Script .mlx	3-3
Convert MuPAD Graphics to MATLAB Graphics	3-3
Known Issues	3-4
Troubleshoot MuPAD to MATLAB Translation Errors	3-8
Troubleshoot MuPAD to MATLAB Translation Warnings	3-15
Differences Between MATLAB and MuPAD Syntax	3-20
Call Built-In MuPAD Functions from MATLAB	3-22
evalin	3-22
feval	3-22
evalin vs. feval	3-23
Floating-Point Arguments of evalin and feval	3-23

Functions

4

Getting Started

- “Symbolic Math Toolbox Product Description” on page 1-2
- “Create Symbolic Numbers, Variables, and Expressions” on page 1-3
- “Create Symbolic Functions” on page 1-7
- “Create Symbolic Matrices” on page 1-9
- “Perform Symbolic Computations” on page 1-11
- “Use Assumptions on Symbolic Variables” on page 1-24

Symbolic Math Toolbox Product Description

Perform symbolic math computations

Symbolic Math Toolbox provides functions for solving, plotting, and manipulating symbolic math equations. You can create, run, and share symbolic math code using the MATLAB Live Editor. The toolbox provides functions in common mathematical areas such as calculus, linear algebra, algebraic and ordinary differential equations, equation simplification, and equation manipulation.

Symbolic Math Toolbox lets you analytically perform differentiation, integration, simplification, transforms, and equation solving. You can perform dimensional computations and conversions using SI and US unit systems. Your computations can be performed either analytically or using variable-precision arithmetic, with the results displayed in mathematical typeset.

You can share your symbolic work with other MATLAB users as live scripts or convert them to HTML or PDF for publication. You can generate MATLAB functions, Simulink[®] function blocks, and Simscape[™] equations directly from symbolic expressions.

Key Features

- Symbolic integration, differentiation, transforms, and linear algebra
- Algebraic and ordinary differential equation (ODE) solvers
- Simplification and manipulation of symbolic expressions
- Unit systems for specifying, converting, and computing using SI, US, and custom unit systems
- Plotting of analytical functions in 2D and 3D
- Symbolic expression conversion to MATLAB, Simulink, Simscape, C, Fortran, and LaTeX code
- Variable-precision arithmetic

Create Symbolic Numbers, Variables, and Expressions

This page shows how to create symbolic numbers, variables, and expressions. To learn how to work with symbolic math, see “Perform Symbolic Computations” on page 1-11.

Create Symbolic Numbers

You can create symbolic numbers by using `sym`. Symbolic numbers are exact representations, unlike floating-point numbers.

Create a symbolic number by using `sym` and compare it to the same floating-point number.

```
sym(1/3)
1/3

ans =
1/3
ans =
    0.3333
```

The symbolic number is represented in exact rational form, while the floating-point number is a decimal approximation. The symbolic result is not indented, while the standard MATLAB result is indented.

Calculations on symbolic numbers are exact. Demonstrate this exactness by finding `sin(pi)` symbolically and numerically. The symbolic result is exact, while the numeric result is an approximation.

```
sin(sym(pi))
sin(pi)

ans =
0
ans =
    1.2246e-16
```

To learn more about symbolic representation of numbers, see “Numeric to Symbolic Conversion” on page 2-136.

Create Symbolic Variables

You can create symbolic variables using either `syms` or `sym`. Typical uses of these functions include:

- `sym` - Create numbered symbolic variables or create symbolic variables in MATLAB functions.
- `syms` - Create *fresh* symbolic variables for interactive symbolic workflows, that is, for symbolic variable creation at the MATLAB command line or in MATLAB live scripts. A *fresh* symbolic variable does not have any assumptions.

The `syms` command is shorthand for the `sym` syntax, but the two functions handle assumptions differently. For more details, see “Reuse Names of Symbolic Objects” on page 1-5.

Create the symbolic variables `x` and `y` using `syms` and `sym`, respectively.

```
syms x
y = sym('y')
```

The first command creates a symbolic variable x in the MATLAB workspace with the value x assigned to the variable x . The second command creates a symbolic variable y with the value y .

With `syms`, you can create multiple variables in one command. Create the variables a , b , and c .

```
syms a b c
```

If you want to create a MATLAB array of numbered symbolic variables, the `syms` syntax is inconvenient. Therefore, use `sym` instead to create an array of many numbered symbolic variables.

Clear the workspace. Create a row vector containing the symbolic variables a_1, \dots, a_{20} and assign it to the MATLAB variable A . Display the variable in the MATLAB workspace.

```
clear all
A = sym('a', [1 20])
whos

A =
[ a1, a2, a3, a4, a5, a6, a7, a8, a9, a10,...
  a11, a12, a13, a14, a15, a16, a17, a18, a19, a20]

Name      Size      Bytes  Class  Attributes
A         1x20           8  sym
```

A is a 1-by-20 array of 20 symbolic variables.

By combining `sym` and `syms`, you can create many fresh symbolic variables with corresponding variables name in the MATLAB workspace.

Clear the workspace. Create the fresh symbolic variables a_1, \dots, a_{10} and assign them the MATLAB variable names a_1, \dots, a_{10} , respectively. Display the variables in the MATLAB workspace.

```
clear all
syms(sym('a', [1 10]))
whos

Name      Size      Bytes  Class  Attributes
a1         1x1           8  sym
a10        1x1           8  sym
a2         1x1           8  sym
a3         1x1           8  sym
a4         1x1           8  sym
a5         1x1           8  sym
a6         1x1           8  sym
a7         1x1           8  sym
a8         1x1           8  sym
a9         1x1           8  sym
```

The MATLAB workspace contains 10 MATLAB variables that are symbolic variables.

The `syms` command is a convenient shorthand for the `sym` syntax, and its typical use is to create fresh symbolic variables for interactive symbolic workflows. Use the `sym` syntax to create the following:

- Symbolic variables in MATLAB functions

- Many numbered symbolic variables
- Symbolic variable whose value differs from its name in the MATLAB workspace
- Symbolic number, such as `sym(5)`
- Symbolic variable that inherits the assumptions from a previously used symbolic variable having the same name

Create Symbolic Expressions

Suppose you want to use a symbolic variable to represent the golden ratio

$$\varphi = \frac{1 + \sqrt{5}}{2}$$

The command

```
phi = (1 + sqrt(sym(5)))/2;
```

achieves this goal. Now you can perform various mathematical operations on `phi`. For example,

```
f = phi^2 - phi - 1
```

returns

```
f =
(5^(1/2)/2 + 1/2)^2 - 5^(1/2)/2 - 3/2
```

Now suppose you want to study the quadratic function $f = ax^2 + bx + c$. First, create the symbolic variables `a`, `b`, `c`, and `x`:

```
syms a b c x
```

Then, assign the expression to `f`:

```
f = a*x^2 + b*x + c;
```

Tip To create a symbolic number, use the `sym` command. Do not use the `syms` function to create a symbolic expression that is a constant. For example, to create the expression whose value is 5, enter `f = sym(5)`. The command `f = 5` does *not* define `f` as a symbolic expression.

Reuse Names of Symbolic Objects

If you set a variable equal to a symbolic expression, and then apply the `syms` command to the variable, MATLAB software removes the previously defined expression from the variable. For example,

```
syms a b
f = a + b
```

returns

```
f =
a + b
```

If later you enter

```
syms f  
f
```

then MATLAB removes the value $a + b$ from the expression f :

```
f =  
f
```

You can use the `syms` command to clear variables of definitions that you previously assigned to them in your MATLAB session. `syms` clears the assumptions of the variables: complex, real, integer, and positive. These assumptions are stored separately from the symbolic object. However, recreating a variable using `sym` does not clear its assumptions. For more information, see “Delete Symbolic Objects and Their Assumptions” on page 1-25.

See Also

More About

- “Create Symbolic Functions” on page 1-7
- “Create Symbolic Matrices” on page 1-9
- “Choose `syms` or `sym` Function” on page 2-5
- “Perform Symbolic Computations” on page 1-11
- “Use Assumptions on Symbolic Variables” on page 1-24

Create Symbolic Functions

Symbolic functions represent math functions. Use symbolic functions for differentiation, integration, solving ODEs, and other math operations. Create symbolic functions by using `syms`.

Create a symbolic function `f` with variables `x` and `y` by using `syms`. Creating `f` automatically creates `x` and `y`.

```
syms f(x,y)
```

Assign a mathematical expression to `f`.

```
f(x,y) = x^2*y
```

```
f(x, y) =  
x^2*y
```

Find the value of `f` at `(3,2)`.

```
f(3,2)
```

```
ans =  
18
```

Symbolic functions accept array inputs. Calculate `f` for multiple values of `x` and `y`.

```
xVal = 1:5;  
yVal = 3:7;  
f(xVal,yVal)
```

```
ans =  
[ 3, 16, 45, 96, 175]
```

You can differentiate symbolic functions, integrate or simplify them, substitute their arguments with values, and perform other mathematical operations. For example, find the derivative of `f(x,y)` with respect to `x`. The result `dfx` is also a symbolic function.

```
dfx = diff(f,x)
```

```
dfx(x,y) =  
2*x*y
```

Calculate `df(x,y)` at `x = y + 1`.

```
dfx(y+1,y)
```

```
ans =  
2*y*(y + 1)
```

If you are creating a constant function, such as `f(x,y) = 1`, you must first create `f(x,y)`. If you do not create `f(x,y)`, then the assignment `f(x,y) = 1` throws an error.

See Also

More About

- “Create Symbolic Numbers, Variables, and Expressions” on page 1-3
- “Create Symbolic Matrices” on page 1-9
- “Perform Symbolic Computations” on page 1-11
- “Use Assumptions on Symbolic Variables” on page 1-24

Create Symbolic Matrices

In this section...

“Use Existing Symbolic Variables” on page 1-9

“Generate Elements While Creating a Matrix” on page 1-9

“Create Matrix of Symbolic Numbers” on page 1-10

Use Existing Symbolic Variables

A circulant matrix has the property that each row is obtained from the previous one by cyclically permuting the entries one step forward. For example, create the symbolic circulant matrix whose elements are a , b , and c , using the commands:

```
syms a b c
A = [a b c; c a b; b c a]

A =
[ a, b, c]
[ c, a, b]
[ b, c, a]
```

Since matrix A is circulant, the sum of elements over each row and each column is the same. Find the sum of all the elements of the first row:

```
sum(A(1,:))

ans =
a + b + c
```

To check if the sum of the elements of the first row equals the sum of the elements of the second column, use the `isAlways` function:

```
isAlways(sum(A(1,:)) == sum(A(:,2)))
```

The sums are equal:

```
ans =
    logical
     1
```

From this example, you can see that using symbolic objects is very similar to using regular MATLAB numeric objects.

Generate Elements While Creating a Matrix

The `sym` function also lets you define a symbolic matrix or vector without having to define its elements in advance. In this case, the `sym` function generates the elements of a symbolic matrix at the same time that it creates a matrix. The function presents all generated elements using the same form: the base (which must be a valid variable name), a row index, and a column index. Use the first argument of `sym` to specify the base for the names of generated elements. You can use any valid variable name as a base. To check whether the name is a valid variable name, use the `isvarname` function. By default, `sym` separates a row index and a column index by underscore. For example, create the 2-by-4 matrix A with the elements $A_{1,1}$, ..., $A_{2,4}$:

```
A = sym('A', [2 4])
```

```
A =  
[ A1_1, A1_2, A1_3, A1_4]  
[ A2_1, A2_2, A2_3, A2_4]
```

To control the format of the generated names of matrix elements, use %d in the first argument:

```
A = sym('A%d%d', [2 4])
```

```
A =  
[ A11, A12, A13, A14]  
[ A21, A22, A23, A24]
```

Create Matrix of Symbolic Numbers

A particularly effective use of `sym` is to convert a matrix from numeric to symbolic form. The command

```
A = hilb(3)
```

generates the 3-by-3 Hilbert matrix:

```
A =  
    1.0000    0.5000    0.3333  
    0.5000    0.3333    0.2500  
    0.3333    0.2500    0.2000
```

By applying `sym` to `A`

```
A = sym(A)
```

you can obtain the precise symbolic form of the 3-by-3 Hilbert matrix:

```
A =  
[ 1, 1/2, 1/3]  
[ 1/2, 1/3, 1/4]  
[ 1/3, 1/4, 1/5]
```

For more information on numeric to symbolic conversions, see “Numeric to Symbolic Conversion” on page 2-136.

See Also

More About

- “Create Symbolic Numbers, Variables, and Expressions” on page 1-3
- “Create Symbolic Functions” on page 1-7
- “Perform Symbolic Computations” on page 1-11
- “Use Assumptions on Symbolic Variables” on page 1-24

Perform Symbolic Computations

In this section...

“Differentiate Symbolic Expressions” on page 1-11
 “Integrate Symbolic Expressions” on page 1-12
 “Solve Equations” on page 1-13
 “Simplify Symbolic Expressions” on page 1-15
 “Substitutions in Symbolic Expressions” on page 1-16
 “Plot Symbolic Functions” on page 1-18

Differentiate Symbolic Expressions

With the Symbolic Math Toolbox software, you can find

- Derivatives of single-variable expressions
- Partial derivatives
- Second and higher order derivatives
- Mixed derivatives

For in-depth information on taking symbolic derivatives see “Differentiation” on page 2-46.

Expressions with One Variable

To differentiate a symbolic expression, use the `diff` command. The following example illustrates how to take a first derivative of a symbolic expression:

```
syms x
f = sin(x)^2;
diff(f)

ans =
2*cos(x)*sin(x)
```

Partial Derivatives

For multivariable expressions, you can specify the differentiation variable. If you do not specify any variable, MATLAB chooses a default variable by its proximity to the letter `x`:

```
syms x y
f = sin(x)^2 + cos(y)^2;
diff(f)

ans =
2*cos(x)*sin(x)
```

For the complete set of rules MATLAB applies for choosing a default variable, see “Find a Default Symbolic Variable” on page 2-3.

To differentiate the symbolic expression `f` with respect to a variable `y`, enter:

```
syms x y
f = sin(x)^2 + cos(y)^2;
diff(f, y)

ans =
-2*cos(y)*sin(y)
```

Second Partial and Mixed Derivatives

To take a second derivative of the symbolic expression f with respect to a variable y , enter:

```
syms x y
f = sin(x)^2 + cos(y)^2;
diff(f, y, 2)

ans =
2*sin(y)^2 - 2*cos(y)^2
```

You get the same result by taking derivative twice: `diff(diff(f, y))`. To take mixed derivatives, use two differentiation commands. For example:

```
syms x y
f = sin(x)^2 + cos(y)^2;
diff(diff(f, y), x)

ans =
0
```

Integrate Symbolic Expressions

You can perform symbolic integration including:

- Indefinite and definite integration
- Integration of multivariable expressions

For in-depth information on the `int` command including integration with real and complex parameters, see “Integration” on page 2-59.

Indefinite Integrals of One-Variable Expressions

Suppose you want to integrate a symbolic expression. The first step is to create the symbolic expression:

```
syms x
f = sin(x)^2;
```

To find the indefinite integral, enter

```
int(f)

ans =
x/2 - sin(2*x)/4
```

Indefinite Integrals of Multivariable Expressions

If the expression depends on multiple symbolic variables, you can designate a variable of integration. If you do not specify any variable, MATLAB chooses a default variable by the proximity to the letter x :

```
syms x y n
f = x^n + y^n;
int(f)

ans =
x*y^n + (x*x^n)/(n + 1)
```

For the complete set of rules MATLAB applies for choosing a default variable, see “Find a Default Symbolic Variable” on page 2-3.

You also can integrate the expression $f = x^n + y^n$ with respect to y

```
syms x y n
f = x^n + y^n;
int(f, y)

ans =
x^n*y + (y*y^n)/(n + 1)
```

If the integration variable is n , enter

```
syms x y n
f = x^n + y^n;
int(f, n)

ans =
x^n/log(x) + y^n/log(y)
```

Definite Integrals

To find a definite integral, pass the limits of integration as the final two arguments of the `int` function:

```
syms x y n
f = x^n + y^n;
int(f, 1, 10)

ans =
piecewise(n == -1, log(10) + 9/y, n ~= -1,...
(10*10^n - 1)/(n + 1) + 9*y^n)
```

If MATLAB Cannot Find a Closed Form of an Integral

If the `int` function cannot compute an integral, it returns an unresolved integral:

```
syms x
int(sin(sinh(x)))

ans =
int(sin(sinh(x)), x)
```

Solve Equations

You can solve different types of symbolic equations including:

- Algebraic equations with one symbolic variable
- Algebraic equations with several symbolic variables

- Systems of algebraic equations

For in-depth information on solving symbolic equations including differential equations, see “Equation Solving”.

Solve Algebraic Equations with One Symbolic Variable

Use the double equal sign (==) to define an equation. Then you can solve the equation by calling the solve function. For example, solve this equation:

```
syms x
solve(x^3 - 6*x^2 == 6 - 11*x)
```

```
ans =
     1
     2
     3
```

If you do not specify the right side of the equation, solve assumes that it is zero:

```
syms x
solve(x^3 - 6*x^2 + 11*x - 6)
```

```
ans =
     1
     2
     3
```

Solve Algebraic Equations with Several Symbolic Variables

If an equation contains several symbolic variables, you can specify a variable for which this equation should be solved. For example, solve this multivariable equation with respect to y:

```
syms x y
solve(6*x^2 - 6*x^2*y + x*y^2 - x*y + y^3 - y^2 == 0, y)
```

```
ans =
     1
    2*x
   -3*x
```

If you do not specify any variable, you get the solution of an equation for the alphabetically closest to x variable. For the complete set of rules MATLAB applies for choosing a default variable see “Find a Default Symbolic Variable” on page 2-3.

Solve Systems of Algebraic Equations

You also can solve systems of equations. For example:

```
syms x y z
[x, y, z] = solve(z == 4*x, x == y, z == x^2 + y^2)
```

```
x =
     0
     2
```

```
y =
     0
```



```

2
z =
0
8

```

Simplify Symbolic Expressions

Symbolic Math Toolbox provides a set of simplification functions allowing you to manipulate the output of a symbolic expression. For example, the following polynomial of the golden ratio `phi`

```

phi = (1 + sqrt(sym(5)))/2;
f = phi^2 - phi - 1

```

returns

```

f =
(5^(1/2)/2 + 1/2)^2 - 5^(1/2)/2 - 3/2

```

You can simplify this answer by entering

```
simplify(f)
```

and get a very short answer:

```

ans =
0

```

Symbolic simplification is not always so straightforward. There is no universal simplification function, because the meaning of a simplest representation of a symbolic expression cannot be defined clearly. Different problems require different forms of the same mathematical expression. Knowing what form is more effective for solving your particular problem, you can choose the appropriate simplification function.

For example, to show the order of a polynomial or symbolically differentiate or integrate a polynomial, use the standard polynomial form with all the parentheses multiplied out and all the similar terms summed up. To rewrite a polynomial in the standard form, use the `expand` function:

```

syms x
f = (x ^2- 1)*(x^4 + x^3 + x^2 + x + 1)*(x^4 - x^3 + x^2 - x + 1);
expand(f)

```

```

ans =
x^10 - 1

```

The `factor` simplification function shows the polynomial roots. If a polynomial cannot be factored over the rational numbers, the output of the `factor` function is the standard polynomial form. For example, to factor the third-order polynomial, enter:

```

syms x
g = x^3 + 6*x^2 + 11*x + 6;
factor(g)

```

```

ans =
[ x + 3, x + 2, x + 1]

```

The nested (Horner) representation of a polynomial is the most efficient for numerical evaluations:

```
syms x
h = x^5 + x^4 + x^3 + x^2 + x;
horner(h)

ans =
x*(x*(x*(x*(x + 1) + 1) + 1) + 1)
```

For a list of Symbolic Math Toolbox simplification functions, see “Choose Function to Rearrange Expression” on page 2-104.

Substitutions in Symbolic Expressions

Substitute Symbolic Variables with Numbers

You can substitute a symbolic variable with a numeric value by using the `subs` function. For example, evaluate the symbolic expression `f` at the point $x = 1/3$:

```
syms x
f = 2*x^2 - 3*x + 1;
subs(f, 1/3)

ans =
2/9
```

The `subs` function does not change the original expression `f`:

```
f

f =
2*x^2 - 3*x + 1
```

Substitute in Multivariate Expressions

When your expression contains more than one variable, you can specify the variable for which you want to make the substitution. For example, to substitute the value $x = 3$ in the symbolic expression

```
syms x y
f = x^2*y + 5*x*sqrt(y);

enter the command

subs(f, x, 3)

ans =
9*y + 15*y^(1/2)
```

Substitute One Symbolic Variable for Another

You also can substitute one symbolic variable for another symbolic variable. For example to replace the variable `y` with the variable `x`, enter

```
subs(f, y, x)

ans =
x^3 + 5*x^(3/2)
```

Substitute a Matrix into a Polynomial

You can also substitute a matrix into a symbolic polynomial with numeric coefficients. There are two ways to substitute a matrix into a polynomial: element by element and according to matrix multiplication rules.

Element-by-Element Substitution

To substitute a matrix at each element, use the `subs` command:

```
syms x
f = x^3 - 15*x^2 - 24*x + 350;
A = [1 2 3; 4 5 6];
subs(f,A)
```

```
ans =
[ 312, 250, 170]
[ 78, -20, -118]
```

You can do element-by-element substitution for rectangular or square matrices.

Substitution in a Matrix Sense

If you want to substitute a matrix into a polynomial using standard matrix multiplication rules, a matrix must be square. For example, you can substitute the magic square `A` into a polynomial `f`:

- 1 Create the polynomial:

```
syms x
f = x^3 - 15*x^2 - 24*x + 350;
```

- 2 Create the magic square matrix:

```
A = magic(3)
```

```
A =
     8     1     6
     3     5     7
     4     9     2
```

- 3 Get a row vector containing the numeric coefficients of the polynomial `f`:

```
b = sym2poly(f)
```

```
b =
     1    -15    -24    350
```

- 4 Substitute the magic square matrix `A` into the polynomial `f`. Matrix `A` replaces all occurrences of `x` in the polynomial. The constant times the identity matrix `eye(3)` replaces the constant term of `f`:

```
A^3 - 15*A^2 - 24*A + 350*eye(3)
```

```
ans =
    -10     0     0
     0    -10     0
     0     0    -10
```

The `polyvalm` command provides an easy way to obtain the same result:

```
polyvalm(b,A)
```

```
ans =  
  -10     0     0  
     0    -10    0  
     0     0    -10
```

Substitute the Elements of a Symbolic Matrix

To substitute a set of elements in a symbolic matrix, also use the `subs` command. Suppose you want to replace some of the elements of a symbolic circulant matrix `A`

```
syms a b c  
A = [a b c; c a b; b c a]
```

```
A =  
[ a, b, c]  
[ c, a, b]  
[ b, c, a]
```

To replace the (2, 1) element of `A` with `beta` and the variable `b` throughout the matrix with variable `alpha`, enter

```
alpha = sym('alpha');  
beta = sym('beta');  
A(2,1) = beta;  
A = subs(A,b,alpha)
```

The result is the matrix:

```
A =  
[  a, alpha,  c]  
[ beta,  a, alpha]  
[ alpha,  c,  a]
```

For more information, see “Substitute Elements in Symbolic Matrices” on page 2-119.

Plot Symbolic Functions

Symbolic Math Toolbox provides the plotting functions:

- `fplot` to create 2-D plots of symbolic expressions, equations, or functions in Cartesian coordinates.
- `fplot3` to create 3-D parametric plots.
- `ezpolar` to create plots in polar coordinates.
- `fsurf` to create surface plots.
- `fcontour` to create contour plots.
- `fmesh` to create mesh plots.

Explicit Function Plot

Create a 2-D line plot by using `fplot`. Plot the expression $x^3 - 6x^2 + 11x - 6$.

```
syms x  
f = x^3 - 6*x^2 + 11*x - 6;  
fplot(f)
```

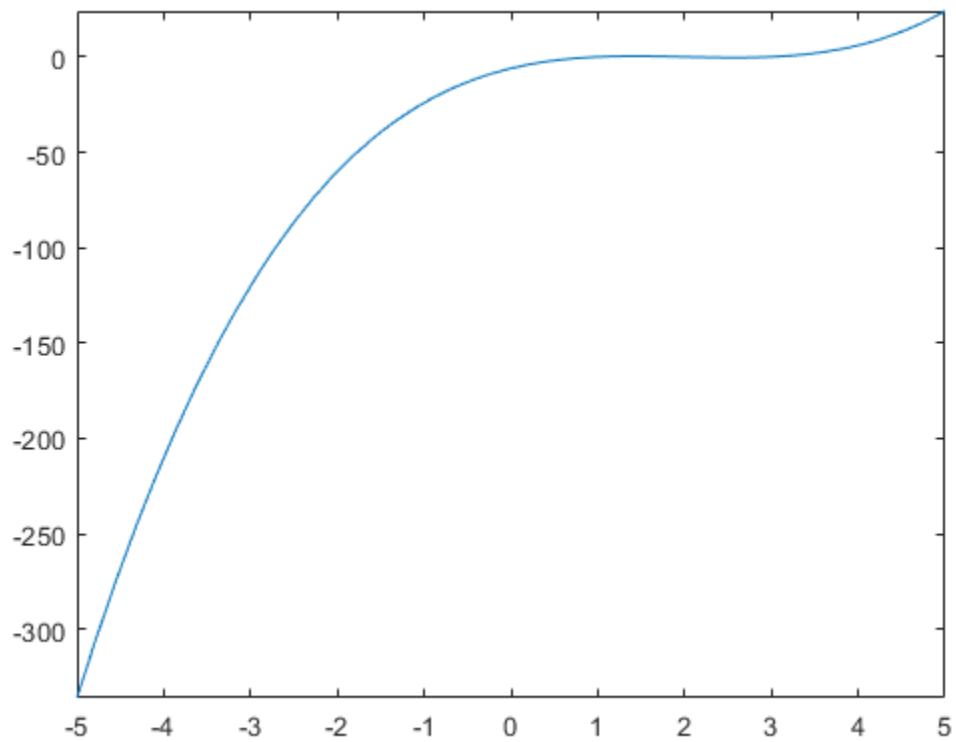

Add labels for the x- and y-axes. Generate the title by using `xlabel(f)`. Show the grid by using `grid on`. For details, see “Add Title and Axis Labels to Chart” (MATLAB).

```
xlabel('x')  
ylabel('y')  
title(textlabel(f))  
grid on
```

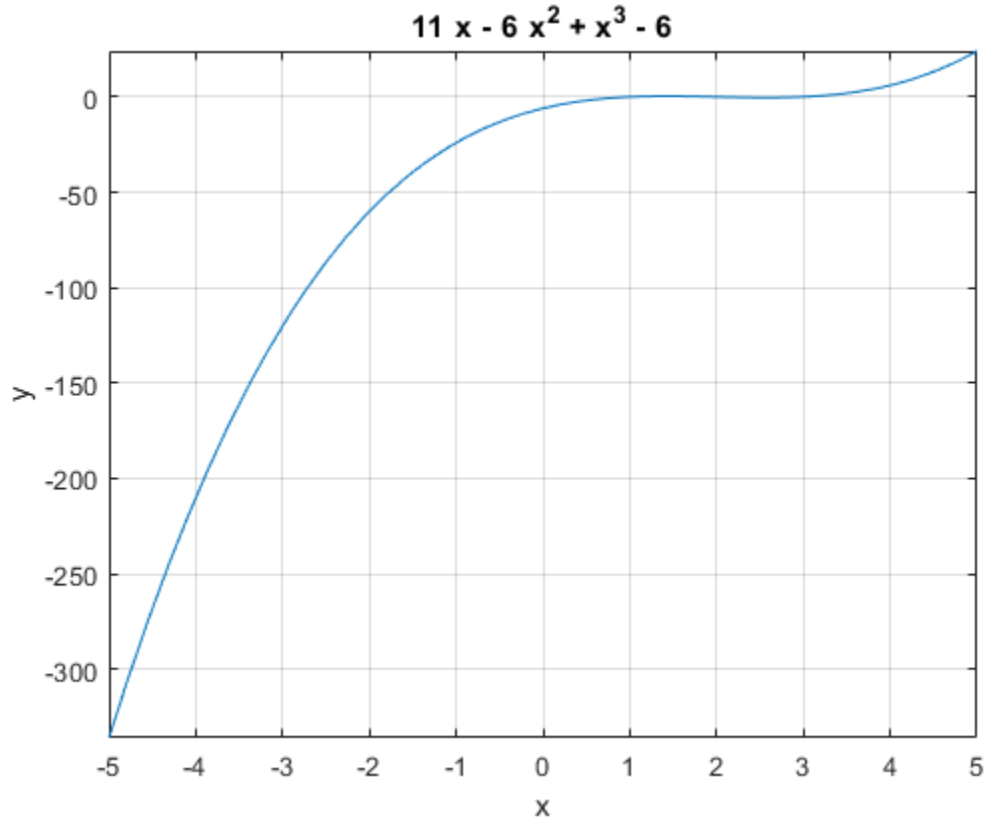

Implicit Function Plot

Plot equations and implicit functions using `fimplicit`.

Plot the equation $(x^2 + y^2)^4 = (x^2 - y^2)^2$ over $-1 < x < 1$.

```
syms x y
eqn = (x^2 + y^2)^4 == (x^2 - y^2)^2;
fimplicit(eqn, [-1 1])
```

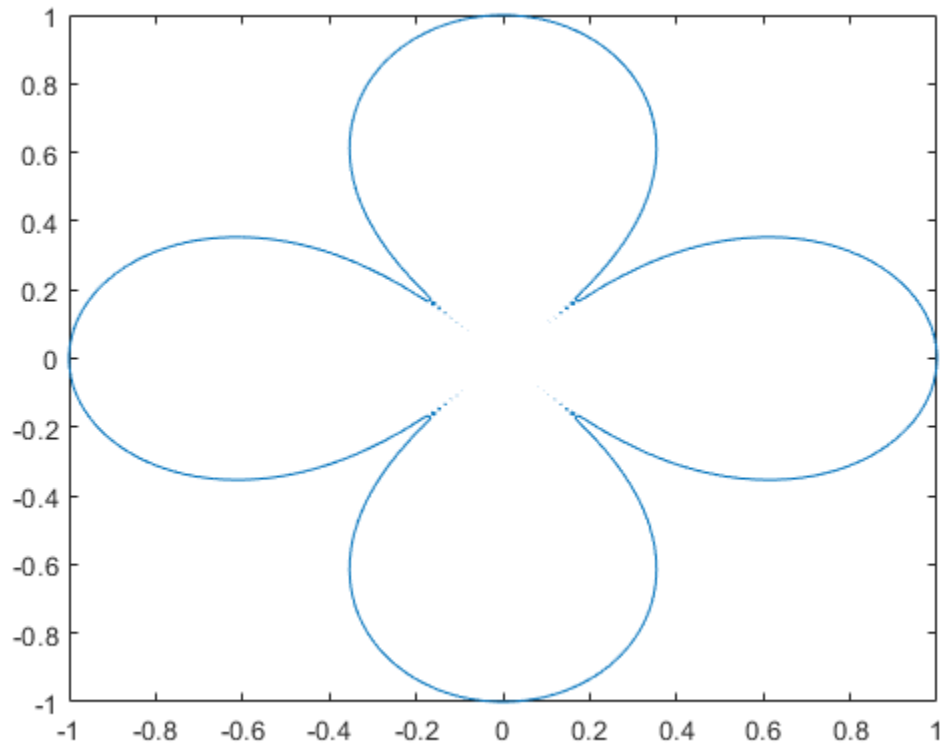

3-D Plot

Plot 3-D parametric lines by using `fplot3`.

Plot the parametric line

$$x = t^2 \sin(10t)$$

$$y = t^2 \cos(10t)$$

$$z = t.$$

```
syms t  
fplot3(t^2*sin(10*t), t^2*cos(10*t), t)
```

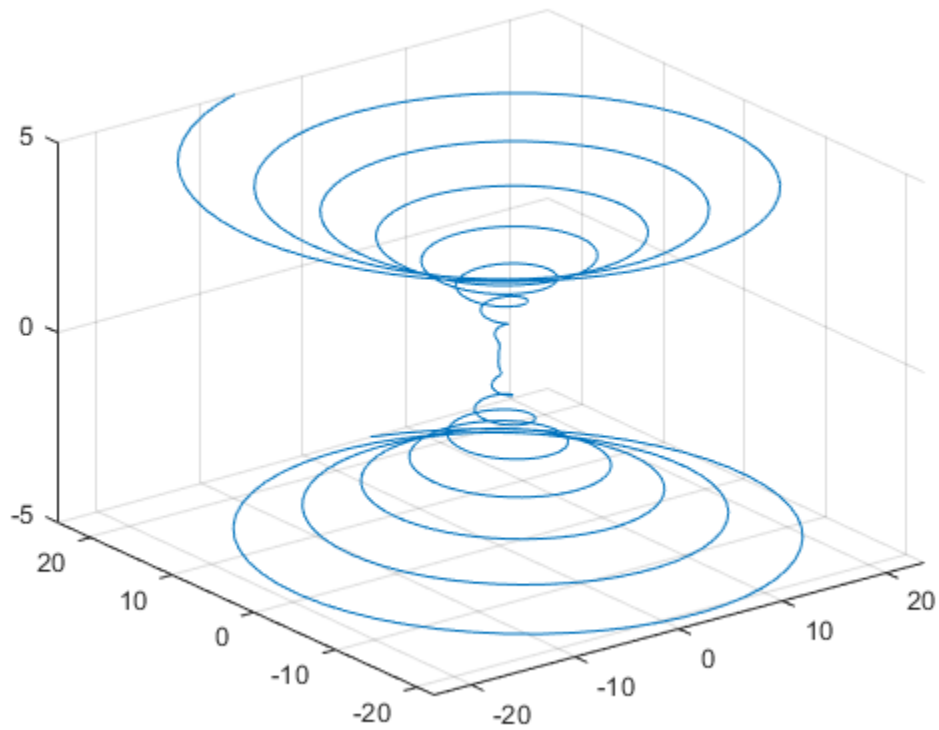

Create Surface Plot

Create a 3-D surface by using `fsurf`.

Plot the paraboloid $z = x^2 + y^2$.

```
syms x y  
fsurf(x^2 + y^2)
```

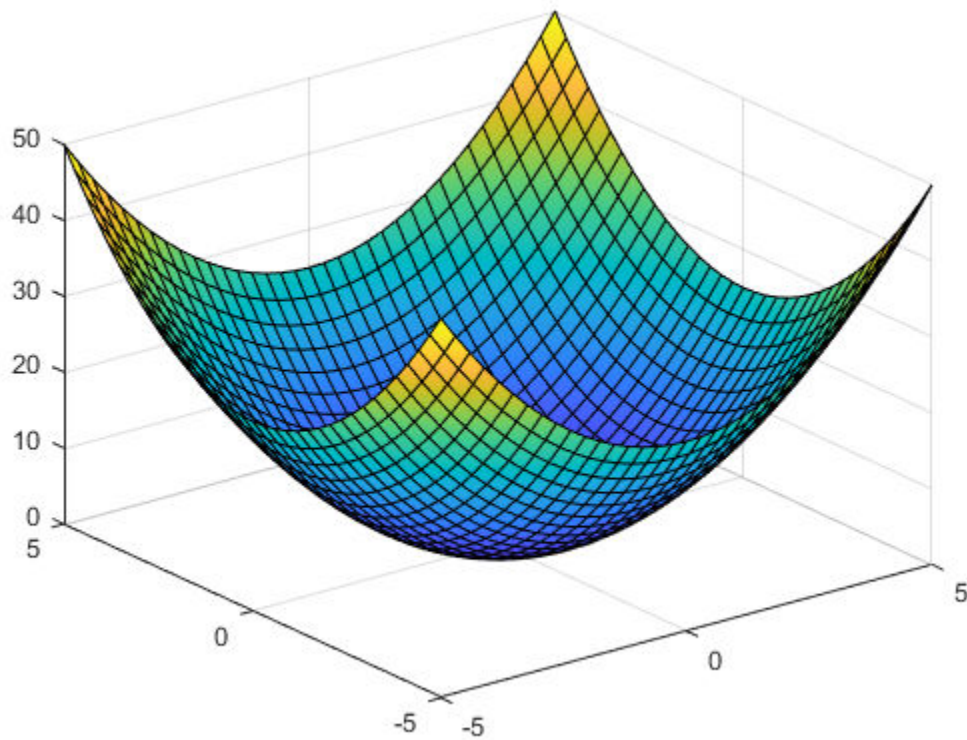
See Also

More About

- “Create Symbolic Numbers, Variables, and Expressions” on page 1-3
- “Create Symbolic Functions” on page 1-7
- “Create Symbolic Matrices” on page 1-9
- “Use Assumptions on Symbolic Variables” on page 1-24

Use Assumptions on Symbolic Variables

In this section...

“Default Assumption” on page 1-24

“Set Assumptions” on page 1-24

“Check Existing Assumptions” on page 1-25

“Delete Symbolic Objects and Their Assumptions” on page 1-25

Default Assumption

In Symbolic Math Toolbox, symbolic variables are complex variables by default. For example, if you declare z as a symbolic variable using

```
syms z
```

then MATLAB assumes that z is a complex variable. You can always check if a symbolic variable is assumed to be complex or real by using `assumptions`. If z is complex, `assumptions(z)` returns an empty symbolic object:

```
assumptions(z)

ans =
Empty sym: 1-by-0
```

Set Assumptions

To set an assumption on a symbolic variable, use the `assume` function. For example, assume that the variable x is nonnegative:

```
syms x
assume(x >= 0)
```

`assume` replaces all previous assumptions on the variable with the new assumption. If you want to add a new assumption to the existing assumptions, use `assumeAlso`. For example, add the assumption that x is also an integer. Now the variable x is a nonnegative integer:

```
assumeAlso(x, 'integer')
```

`assume` and `assumeAlso` let you state that a variable or an expression belongs to one of these sets: integers, positive numbers, rational numbers, and real numbers.

Alternatively, you can set an assumption while declaring a symbolic variable using `sym` or `syms`. For example, create the real symbolic variables a and b , and the positive symbolic variable c :

```
a = sym('a', 'real');
b = sym('b', 'real');
c = sym('c', 'positive');
```

or more efficiently:

```
syms a b real
syms c positive
```

The assumptions that you can assign to a symbolic object with `sym` or `syms` are real, rational, integer and positive.

Check Existing Assumptions

To see all assumptions set on a symbolic variable, use the `assumptions` function with the name of the variable as an input argument. For example, this command returns the assumptions currently used for the variable `x`:

```
assumptions(x)
```

To see all assumptions used for all symbolic variables in the MATLAB workspace, use `assumptions` without input arguments:

```
assumptions
```

For details, see “Check Assumptions Set on Variables” on page 2-113.

Delete Symbolic Objects and Their Assumptions

Symbolic objects and their assumptions are stored separately. When you set an assumption that `x` is real using

```
syms x
assume(x, 'real')
```

you actually create a symbolic object `x` and the assumption that the object is real. The object is stored in the MATLAB workspace, and the assumption is stored in the symbolic engine. When you delete a symbolic object from the MATLAB workspace using

```
clear x
```

the assumption that `x` is real stays in the symbolic engine. If you declare a new symbolic variable `x` later using `sym`, it inherits the assumption that `x` is real instead of getting a default assumption. If later you solve an equation and simplify an expression with the symbolic variable `x`, you could get incomplete results.

Note If you declare a variable using `syms`, existing assumptions are cleared. If you declare a variable using `sym`, existing assumptions are not cleared.

For example, the assumption that `x` is real causes the polynomial $x^2 + 1$ to have no roots:

```
syms x real
clear x
x = sym('x');
solve(x^2 + 1 == 0, x)
```

```
ans =
Empty sym: 0-by-1
```

The complex roots of this polynomial disappear because the symbolic variable `x` still has the assumption that `x` is real stored in the symbolic engine. To clear the assumption, enter

```
syms x
```

After you clear the assumption, the symbolic object stays in the MATLAB workspace. If you want to remove both the symbolic object and its assumption, use two commands:

1 To clear the assumption, enter

```
syms x
```

2 To delete the symbolic object, enter

```
clear x
```

For details on clearing symbolic variables, see “Clear Assumptions and Reset the Symbolic Engine” on page 2-112.

See Also

More About

- “Create Symbolic Numbers, Variables, and Expressions” on page 1-3
- “Create Symbolic Functions” on page 1-7
- “Create Symbolic Matrices” on page 1-9
- “Perform Symbolic Computations” on page 1-11

Using Symbolic Math Toolbox Software

- “Find Symbolic Variables in Expressions, Functions, Matrices” on page 2-3
- “Choose syms or sym Function” on page 2-5
- “Add Subscripts, Superscripts, and Accents to Symbolic Variables” on page 2-8
- “Change Output Display Format of Symbolic Results” on page 2-12
- “Copy and Paste Symbolic Output in Live Editor” on page 2-15
- “Units of Measurement Tutorial” on page 2-19
- “Units and Unit Systems List” on page 2-25
- “Unit Conversions and Unit Systems” on page 2-39
- “Differentiation” on page 2-46
- “Functional Derivatives Tutorial” on page 2-51
- “Limits” on page 2-56
- “Integration” on page 2-59
- “Symbolic Summation” on page 2-65
- “Taylor Series” on page 2-67
- “Padé Approximant” on page 2-69
- “Find Asymptotes, Critical, and Inflection Points” on page 2-76
- “Simplify Symbolic Expressions” on page 2-81
- “Solve Algebraic Equation Using Live Editor Task” on page 2-86
- “Simplify Symbolic Expressions Using Live Editor Task” on page 2-94
- “Abbreviate Common Terms in Long Expressions” on page 2-101
- “Choose Function to Rearrange Expression” on page 2-104
- “Clear Assumptions and Reset the Symbolic Engine” on page 2-112
- “Extract Numerators and Denominators of Rational Expressions” on page 2-115
- “Substitute Variables in Symbolic Expressions” on page 2-117
- “Substitute Elements in Symbolic Matrices” on page 2-119
- “Substitute Scalars with Matrices” on page 2-121
- “Evaluate Symbolic Expressions Using subs” on page 2-123
- “Choose Numeric or Symbolic Arithmetic” on page 2-124
- “Increase Precision of Numeric Calculations” on page 2-128
- “Recognize and Avoid Round-Off Errors” on page 2-130
- “Increase Speed by Reducing Precision” on page 2-134
- “Numeric to Symbolic Conversion” on page 2-136
- “Basic Algebraic Operations” on page 2-139
- “Linear Algebraic Operations” on page 2-141
- “Eigenvalues” on page 2-145

- “Jordan Canonical Form” on page 2-149
- “Singular Value Decomposition” on page 2-151
- “Solve Algebraic Equation” on page 2-153
- “Solve a Second-Order Differential Equation Numerically” on page 2-157
- “Select Numeric or Symbolic Solver” on page 2-159
- “Solve System of Algebraic Equations” on page 2-160
- “Troubleshoot Equation Solutions from solve Function” on page 2-169
- “Solve System of Linear Equations” on page 2-173
- “Solve Equations Numerically” on page 2-176
- “Solve Differential Equation” on page 2-185
- “Solve a System of Differential Equations” on page 2-189
- “Solve Differential Algebraic Equations (DAEs)” on page 2-194
- “Solve Semilinear DAE System” on page 2-203
- “Solve DAEs Using Mass Matrix Solvers” on page 2-209
- “Fourier and Inverse Fourier Transforms” on page 2-214
- “Solve Differential Equations Using Laplace Transform” on page 2-218
- “Solve Difference Equations Using Z-Transform” on page 2-224
- “Create Plots” on page 2-229
- “Plotting in Spherical Coordinate System” on page 2-239
- “Analytical Solutions of the Inverse Kinematics of a Humanoid Robot” on page 2-241
- “Analytical Model of Cantilever Truss Structure for Simscape” on page 2-252
- “Estimate Model Parameters of a Symbolically Derived Plant Model in Simulink” on page 2-260
- “Generate C or Fortran Code from Symbolic Expressions” on page 2-266
- “Generate MATLAB Functions from Symbolic Expressions” on page 2-267
- “Generate MATLAB Function Blocks from Symbolic Expressions” on page 2-270
- “Generate Simscape Equations from Symbolic Expressions” on page 2-272

Find Symbolic Variables in Expressions, Functions, Matrices

To find symbolic variables in an expression, function, or matrix, use `symvar`. For example, find all symbolic variables in symbolic expressions `f` and `g`:

```
syms a b n t x
f = x^n;
g = sin(a*t + b);
symvar(f)
```

```
ans =
[ n, x]
```

Here, `symvar` sorts all returned variables alphabetically. Similarly, you can find the symbolic variables in `g` by entering:

```
symvar(g)
```

```
ans =
[ a, b, t]
```

`symvar` also can return the first `n` symbolic variables found in a symbolic expression, matrix, or function. To specify the number of symbolic variables that you want `symvar` to return, use the second parameter of `symvar`. For example, return the first two variables found in symbolic expression `g`:

```
symvar(g, 2)
```

```
ans =
[ b, t]
```

Notice that the first two variables in this case are not `a` and `b`. When you call `symvar` with two arguments, it finds symbolic variables by their proximity to `x` before sorting them alphabetically.

When you call `symvar` on a symbolic function, `symvar` returns the function inputs before other variables.

```
syms x y w z
f(w, z) = x*w + y*z;
symvar(f)
```

```
ans =
[ w, z, x, y]
```

When called with two arguments for symbolic functions, `symvar` also follows this behavior.

```
symvar(f, 2)
```

```
ans =
[ w, z]
```

Find a Default Symbolic Variable

If you do not specify an independent variable when performing substitution, differentiation, or integration, MATLAB uses a default variable. The default variable is typically the one closest alphabetically to `x` or, for symbolic functions, the first input argument of a function. To find which variable is chosen as a default variable, use the `symvar(f, 1)` command. For example:

```
syms s t
f = s + t;
symvar(f, 1)
```

```
ans =
t
```

```
syms sx tx
f = sx + tx;
symvar(f, 1)
```

```
ans =
tx
```

For more information on choosing the default symbolic variable, see `symvar`.

Choose syms or sym Function

In Symbolic Math Toolbox™, you can declare symbolic objects using either `syms` or `sym`. These two functions are conceptually different.

- The `syms` function *creates* a symbolic object that is automatically assigned to a MATLAB® variable with the same name.
- The `sym` function *refers* to a symbolic object that can be assigned to a MATLAB variable with the same name or a different name.

Assign Symbolic Variables to MATLAB Variables

The `syms` function *creates* a variable dynamically. For example, the command `syms x` creates the symbolic variable `x` and automatically assigns it to a MATLAB variable with the same name.

```
syms x
x
x = x
```

The `sym` function *refers* to a symbolic variable, which you can then assign to a MATLAB variable with a different name. For example, the command `f1 = sym('x')` refers to the symbolic variable `x` and assigns it to the MATLAB variable `f1`.

```
f1 = sym('x')
f1 = x
```

Create Symbolic Number

Use the `syms` function to *create* a symbolic variable `x` and automatically assign it to a MATLAB variable `x`. When you assign a number to the MATLAB variable `x`, the number is represented in double-precision and this assignment overwrites the previous assignment to a symbolic variable. The class of `x` becomes `double`.

```
syms x
x = 1/33
x = 0.0303
class(x)
ans =
'double'
```

Use the `sym` function to *refer* to an exact symbolic number without floating-point approximation. You can then assign this number to the MATLAB variable `x`. The class of `x` is `sym`.

```
x = sym('1/33')
x =
    1
   33
class(x)
ans =
'sym'
```

Create Symbolic Variable with Assumptions

When you create a symbolic variable with an assumption, MATLAB stores the symbolic variable and its assumption separately.

Use `syms` to *create* a symbolic variable that is assigned to a MATLAB variable with the same name. You get a fresh symbolic variable with no assumptions. If you declare a variable using `syms`, existing assumptions are cleared.

```
syms x positive
syms x
assumptions
```

```
ans =
```

```
Empty sym: 1-by-0
```

Use `sym` to *refer* to an existing symbolic variable. If this symbolic variable was used in your MATLAB session before, then `sym` refers to it and its current assumption. If it was not used before, then `sym` creates it with no assumptions.

```
syms x positive
x = sym('x');
assumptions
```

```
ans = 0 < x
```

Create Many Symbolic Variables

To *create* many symbolic variables simultaneously, using the `syms` function is more convenient. You can create multiple variables in one line of code.

```
syms a b c
```

When you use `sym`, you have to declare MATLAB variables one by one and *refer* them to the corresponding symbolic variables.

```
a = sym('a');
b = sym('b');
c = sym('c');
```

Create Array of Symbolic Variables

To declare a symbolic array that contains symbolic variables as its elements, you can use either `syms` or `sym`.

The command `syms a [1 3]` *creates* a 1-by-3 symbolic array `a` and the symbolic variables `a1`, `a2`, and `a3` in the workspace. The symbolic variables `a1`, `a2`, and `a3` are automatically assigned to the symbolic array `a`.

```
clear all
syms a [1 3]
a
```

```
a = (a1 a2 a3)
```

```
whos
```

Name	Size	Bytes	Class	Attributes
a	1x3	8	sym	
a1	1x1	8	sym	
a2	1x1	8	sym	
a3	1x1	8	sym	

The command `a = sym('a',[1 3])` refers to the symbolic variables `a1`, `a2`, and `a3`, which are assigned to the symbolic array `a` in the workspace. The elements `a1`, `a2`, and `a3` are not created in the workspace.

```
clear all
a = sym('a',[1 3])

a = (a1 a2 a3)
```

```
whos
```

Name	Size	Bytes	Class	Attributes
a	1x3	8	sym	

Symbolic Variable in Nested Function

To declare a symbolic variable within a nested function, use `sym`. For example, you can explicitly define a MATLAB variable `x` in the parent function workspace and refer `x` to a symbolic variable with the same name.

```
function primaryFx
    x = sym('x')
    function nestedFx
        ...
    end
end
```

Nested functions make the workspace static, so you cannot dynamically add variables using `syms`.

See Also

Related Examples

- “Create Symbolic Numbers, Variables, and Expressions” on page 1-3
- “Find Symbolic Variables in Expressions, Functions, Matrices” on page 2-3
- “Use Assumptions on Symbolic Variables” on page 1-24

Add Subscripts, Superscripts, and Accents to Symbolic Variables

This example shows how to add subscripts, superscripts, and accents to symbolic variables. MATLAB® Live Editor displays symbolic variables with subscripts, superscripts, and accents in standard mathematical notation.

Add Subscripts and Superscripts

To add subscripts to symbolic variables in live scripts, append the corresponding index to the variable using one underscore (_). For example, create two symbolic variables with subscripts using `syms`. Use these variables in an expression.

```
syms F_a F_b
Ftot = F_a + F_b

Ftot =  $F_a + F_b$ 
```

You can also use `sym` to create a symbolic variable with a subscript and assign the variable to a symbolic expression.

```
Fa = sym('F_a')

Fa =  $F_a$ 
```

To add superscripts to symbolic variables, append the corresponding index to the variable using two underscores (__). For example, create two symbolic variables with superscripts.

```
syms F__a F__b
Ftot = F__a + F__b

Ftot =  $F^a + F^b$ 
```

When you assign symbolic variables to an expression, the symbolic expression is displayed in ASCII format.

Add Accents

To add accents to symbolic variables in live scripts, append the corresponding suffix to the variable using the underscore (_). For example, create symbolic variables with one dot and two dots over the symbol x . Use these variables in an equation.

```
syms x x_dot x_ddot c m k
eq1 = m*x_ddot - c*x_dot + k*x == 0

eq1 =  $kx - c\dot{x} + m\ddot{x} = 0$ 
```

When you compute the complex conjugate of a symbolic variable with an accent, a bar notation is added above the variable. For example, find the complex conjugate of `x_dot` using the `conj` function.

```
xConj = conj(x_dot)

xConj =  $\overline{\dot{x}}$ 
```

The supported accent suffixes for symbolic variables follow.

```

suffix = ["ast"; "hat"; "tilde"; "vec"; "bar"; ...
          "ubar"; "dot"; "ddot"; "tdot"; "qdot"; ...
          "prime"; "dprime"; "tprime"; "qprime"];
accentList = [suffix, sym("x_" + suffix)]

accentList =
    ( ast  x*
      hat  x̂
      tilde x̃
      vec  x→
      bar  x̄
      ubar x̅
      dot  ẋ
      ddot ẍ
      tdot x̣
      qdot x̣
      prime x′
      dprime x″
      tprime x‴
      qprime x‴)

```

When you compute the complex conjugate transpose of a matrix containing symbolic variables, a bar notation is also added above each variable. For example, find the conjugate transpose of the symbolic variables in `accentList(:,2)` using the `ctranspose` or `'` function.

```

conjVar = accentList(:,2) '

conjVar =
    (x* x̂ x̃ x→ x̄ x̅ ẋ ẍ x̣ x̣ x′ x″ x‴ x‴)

```

When you compute the nonconjugate transpose of a matrix containing symbolic variables, the display output is unchanged. For example, find the nonconjugate transpose of the symbolic variables in `accentList(:,2)` using the `transpose` or `.'` function.

```

nonconjVar = accentList(:,2) .'

nonconjVar =
    (x* x̂ x̃ x→ x̄ x̅ ẋ ẍ x̣ x̣ x′ x″ x‴ x‴)

```

Add Multiple Subscripts, Superscripts, and Accents

You can create symbolic variables with multiple subscripts, superscripts, and accents. The multiple suffixes are assigned to the symbolic variables from left to right.

Create symbolic variables with multiple subscripts and superscripts. If you add multiple subscripts and superscripts, then the input indices are separated with a comma sign and displayed from left to right.

```

x1 = sym('x_b_1_a_1')

x1 = xb,1a

x2 = sym('x__b_1_a__1')

```

$$x2 = x_{1,a}^{b,1}$$

Now create symbolic variables with multiple accents. If you add multiple accents, then the input accents are assigned from left to right to the closest preceding variable or index. Some examples follow.

```
v1 = sym('v_prime_vec')
```

$$v1 = \vec{v}$$

```
v2 = sym('v_vec_prime')
```

$$v2 = \vec{v'}$$

```
va = sym('v__a_bar_prime')
```

$$va = v^{\bar{a}}$$

```
vb = sym('v_bar__b_prime')
```

$$vb = \bar{v}^{b'}$$

Adding suffixes to the symbolic variables can produce similar output. However, the variables are equal only if their suffixes are also in the same order. For example, create three symbolic variables that produce similar output.

```
syms F_t__a
```

```
F1 = F_t__a
```

$$F1 = F_t^a$$

```
F2 = sym('F_t__a')
```

$$F2 = F_t^a$$

```
F3 = sym('F__a_t')
```

$$F3 = F_t^a$$

Determine if the symbolic variables are equal to each other using the `isequal` function.

```
TF_12 = isequal(F1,F2)
```

$$TF_{12} = \underset{1}{logical}$$

```
TF_23 = isequal(F2,F3)
```

$TF_{23} = \text{logical}$
 0

See Also

Related Examples

- “Create Symbolic Numbers, Variables, and Expressions” on page 1-3
- “Find Symbolic Variables in Expressions, Functions, Matrices” on page 2-3
- “Use Assumptions on Symbolic Variables” on page 1-24

Change Output Display Format of Symbolic Results

This example shows how to modify the output display format of symbolic results in Symbolic Math Toolbox™ by using the `sympref` function. To demonstrate the use of the function, this example uses a third-degree polynomial.

Modify Output Order of Third-Degree Polynomial

Create a third-degree polynomial consisting of one variable and three coefficients. Define the variable and coefficients as symbolic variables by using the `syms` command.

```
syms x a b c
f(x) = (a*x^2 + b)*(b*x - a) + c

f(x) = c - (a*x^2 + b)(a - b*x)
```

Symbolic preferences persist through successive MATLAB® sessions. Restore all symbolic preferences to the default values. Expand the polynomial and return the output in the default order.

```
sympref('default');
poly = expand(f)

poly(x) = -a^2*x^2 + a*b*x^3 - a*b + b^2*x + c
```

The default output format displays the terms of a symbolic polynomial in alphabetical order, without distinguishing the different symbolic variables in each monomial term.

To change the output order of a polynomial, set the `'PolynomialDisplayStyle'` preference. The `'ascend'` option sorts the output in an ascending order based on the standard mathematical notation for polynomials. Here, the variable `x` with the highest order in a monomial term is displayed last.

```
sympref('PolynomialDisplayStyle','ascend');
poly

poly(x) = c - a*b + b^2*x - a^2*x^2 + a*b*x^3
```

Modify Output Display of Polynomial Roots

By default, symbolic results in Live Scripts are typeset in standard mathematical notation, long expressions are abbreviated, and matrices are set in parentheses (round brackets). You can modify the output display format by setting the symbolic preferences.

Find the roots or zeros of the third-degree polynomial using `solve`. In Symbolic Math Toolbox, the `root` function represents the roots of a polynomial.

```
sols = solve(poly,x)

sols =
    (root(σ1, z, 1)
     root(σ1, z, 2)
     root(σ1, z, 3))
```

where

$$\sigma_1 = a b z^3 - a^2 z^2 + b^2 z - a b + c$$

To display the results without being abbreviated, set 'AbbreviateOutput' preference to false.

```
sympref('AbbreviateOutput', false);
sols
```

```
sols =

$$\begin{pmatrix} \text{root}(a b z^3 - a^2 z^2 + b^2 z - a b + c, z, 1) \\ \text{root}(a b z^3 - a^2 z^2 + b^2 z - a b + c, z, 2) \\ \text{root}(a b z^3 - a^2 z^2 + b^2 z - a b + c, z, 3) \end{pmatrix}$$

```

To display the symbolic matrix with square brackets, rather than parentheses, set 'MatrixWithSquareBrackets' preference to true.

```
sympref('MatrixWithSquareBrackets', true);
sols
```

```
sols =

$$\begin{bmatrix} \text{root}(a b z^3 - a^2 z^2 + b^2 z - a b + c, z, 1) \\ \text{root}(a b z^3 - a^2 z^2 + b^2 z - a b + c, z, 2) \\ \text{root}(a b z^3 - a^2 z^2 + b^2 z - a b + c, z, 3) \end{bmatrix}$$

```

To display the results in ASCII characters instead of in typeset mathematical notation, set 'TypesetOutput' preference to false.

```
sympref('TypesetOutput', false);
sols
```

```
sols =
root(a*b*z^3 - a^2*z^2 + b^2*z - a*b + c, z, 1)
root(a*b*z^3 - a^2*z^2 + b^2*z - a*b + c, z, 2)
root(a*b*z^3 - a^2*z^2 + b^2*z - a*b + c, z, 3)
```

The preferences you set using `sympref` persist through your current and future MATLAB sessions. Restore the symbolic preferences to the default values for the next step.

```
sympref('default');
```

Display Floating-Point Output of Symbolic Numbers

Replace the polynomial coefficients with symbolic numbers using `subs`. The function returns the solutions without any approximation.

```
numSols = subs(sols, [a b c], [sqrt(2) pi 0.001])
```

```
numSols =

$$\begin{pmatrix} \text{root}(\sigma_1, z, 1) \\ \text{root}(\sigma_1, z, 2) \\ \text{root}(\sigma_1, z, 3) \end{pmatrix}$$

```

where

$$\sigma_1 = 1000 \pi \sqrt{2} z^3 - 2000 z^2 + 1000 z \pi^2 - 1000 \pi \sqrt{2} + 1$$

To display the results in floating-point format, set `'FloatingPointOutput'` preference to `true`. This option displays symbolic numbers in fixed-decimal format with 4 digits after the decimal point. For a complex result of class `'sym'`, this preference affects the real and imaginary parts independently.

```
sympref('FloatingPointOutput',true);  
numSols
```

```
numSols =  
    ( 0.4501  
    4.6427e-05 - 1.4904 i  
    4.6427e-05 + 1.4904 i )
```

The display preferences you set do not affect the computation of symbolic results. You can use the `vpa` function to approximate symbolic numbers in floating-point precision with 4 significant digits.

```
vpaSols = vpa(numSols,4)
```

```
vpaSols =  
    ( 0.4501  
    -1.4904 i  
    1.4904 i )
```

Restore the default value of `'FloatingPointOutput'` by specifying the `'default'` option.

```
sympref('FloatingPointOutput','default');
```

Copy and Paste Symbolic Output in Live Editor

This example shows how to copy symbolic output and paste it as MATLAB code or equation typeset in the MATLAB® Live Editor. To demonstrate this capability, this example uses a cubic (third-degree) polynomial.

Copy Output and Paste as MATLAB Code

Solve the cubic polynomial $x^3 + bx + c = 0$. The solutions are displayed in terms of the abbreviated expression σ_1 .

```
syms b c x
S = solve(x^3 + b*x + c == 0, x, 'MaxDegree', 3)
```

S =

$$\begin{pmatrix} \sigma_1 - \frac{b}{3\sigma_1} \\ \frac{b}{6\sigma_1} - \frac{\sigma_1}{2} - \frac{\sqrt{3}\left(\frac{b}{3\sigma_1} + \sigma_1\right) i}{2} \\ \frac{b}{6\sigma_1} - \frac{\sigma_1}{2} + \frac{\sqrt{3}\left(\frac{b}{3\sigma_1} + \sigma_1\right) i}{2} \end{pmatrix}$$

where

$$\sigma_1 = \left(\sqrt{\frac{b^3}{27} + \frac{c^2}{4}} - \frac{c}{2} \right)^{1/3}$$

Right-click the symbolic output. Select **Copy Output** to copy the symbolic expressions that represent the roots of the cubic polynomial.

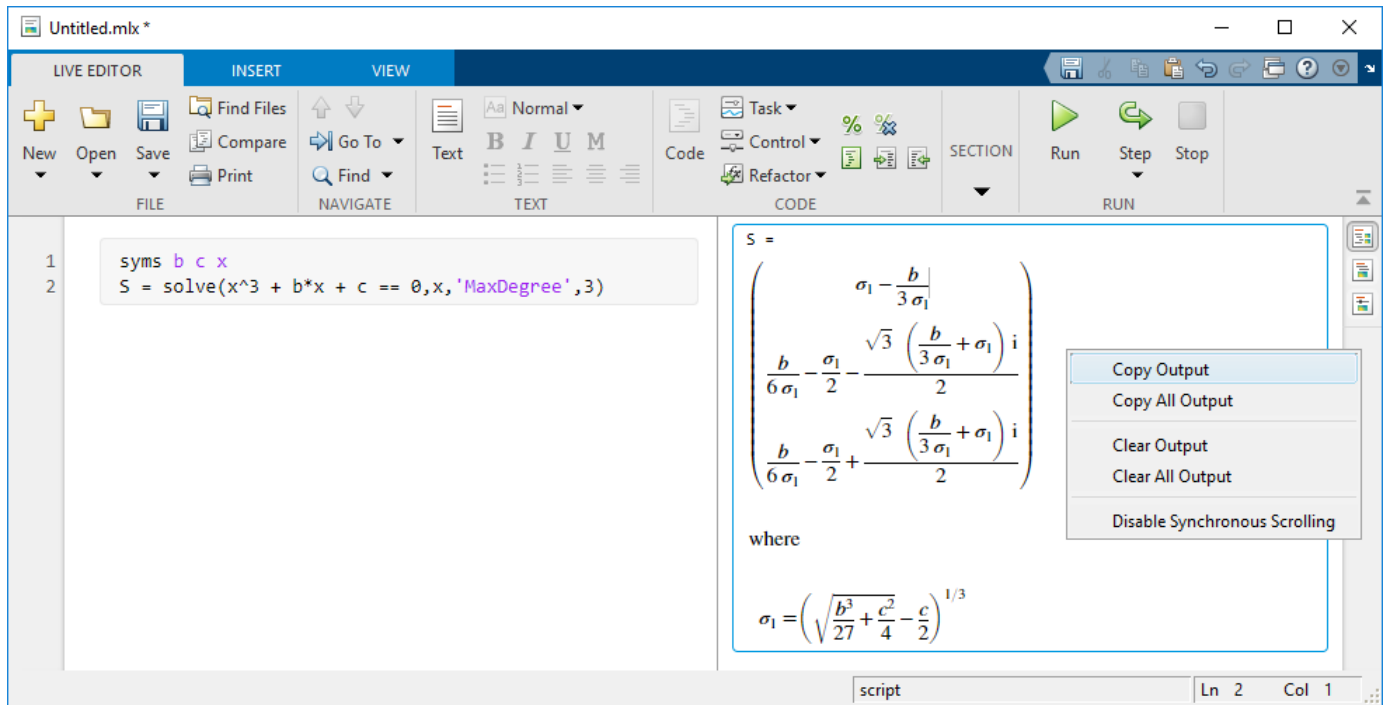

Insert code in the live script and assign the polynomial roots to the variable `Sol`. Then paste the output as MATLAB code using **Ctrl + V** (or right-click and select **Paste**). Pasting the output as MATLAB code automatically expands the abbreviated expression.

```

Sol = [(sqrt(b^3/27 + c^2/4) - c/2)^sym(1/3) - b/(3*(sqrt(b^3/27 + c^2/4) - c/2)^sym(1/3));
       b/(6*(sqrt(b^3/27 + c^2/4) - c/2)^sym(1/3)) - (sqrt(b^3/27 + c^2/4) - c/2)^sym(1/3)/2 - (s
       b/(6*(sqrt(b^3/27 + c^2/4) - c/2)^sym(1/3)) - (sqrt(b^3/27 + c^2/4) - c/2)^sym(1/3)/2 + (s

```

Sol =

$$\begin{pmatrix} \sigma_1 - \frac{b}{3\sigma_1} \\ \frac{b}{6\sigma_1} - \frac{\sigma_1}{2} - \frac{\sqrt{3} \left(\frac{b}{3\sigma_1} + \sigma_1 \right) i}{2} \\ \frac{b}{6\sigma_1} - \frac{\sigma_1}{2} + \frac{\sqrt{3} \left(\frac{b}{3\sigma_1} + \sigma_1 \right) i}{2} \end{pmatrix}$$

where

$$\sigma_1 = \left(\sqrt{\frac{b^3}{27} + \frac{c^2}{4}} - \frac{c}{2} \right)^{1/3}$$

Copy Selected Output and Paste as MATLAB Code

Select the first solution of the cubic polynomial. When selecting a subexpression, you can copy and paste only the subexpression that is on the right side of the equal sign. Right-click the existing selection and choose **Copy (Ctrl + C)** in the context menu.

The screenshot shows the MATLAB Live Editor window titled "Untitled.mlx". The interface includes a menu bar with "LIVE EDITOR", "INSERT", and "VIEW" tabs. Below the menu bar are toolbars for "FILE", "NAVIGATE", "TEXT", "CODE", and "RUN".

In the script editor on the left, the following code is entered:

```
1 syms b c x
2 S = solve(x^3 + b*x + c == 0, x, 'MaxDegree', 3)
```

The output area on the right displays the symbolic solution for S. The first root is highlighted in blue, and a context menu is open over it, showing options: "Copy (Ctrl+C)", "Copy as LaTeX", and "Copy as MathML".

$$S = \left(\begin{array}{l} \sigma_1 - \frac{b}{3\sigma_1} \\ \frac{b}{6\sigma_1} - \frac{\sigma_1}{2} - \frac{\sqrt{3}}{2} \left(\frac{b}{3\sigma_1} + \sigma_1 \right) i \\ \frac{b}{6\sigma_1} - \frac{\sigma_1}{2} + \frac{\sqrt{3}}{2} \left(\frac{b}{3\sigma_1} + \sigma_1 \right) i \end{array} \right)$$

where

$$\sigma_1 = \left(\sqrt{\frac{b^3}{27} + \frac{c^2}{4}} - \frac{c}{2} \right)^{1/3}$$

The status bar at the bottom indicates "script" and "Ln 2 Col 1".

Insert code in the live script and assign the first root of the polynomial to the variable **S1**. Then paste the output as MATLAB code using **Ctrl + V** (or right-click and select **Paste**). Pasting the output as MATLAB code automatically expands the abbreviated expression.

S1 = (sqrt(b^3/27 + c^2/4) - c/2)^sym(1/3) - b/(3*(sqrt(b^3/27 + c^2/4) - c/2)^sym(1/3))

$$S1 = \left(\sqrt{\frac{b^3}{27} + \frac{c^2}{4}} - \frac{c}{2} \right)^{1/3} - \frac{b}{3 \left(\sqrt{\frac{b^3}{27} + \frac{c^2}{4}} - \frac{c}{2} \right)^{1/3}}$$

Copy Selected Output and Paste as Equation Typeset

You can also paste a selection as equation typeset. Select the second solution of the cubic polynomial. Right-click the selection and choose **Copy (Ctrl + C)** in the context menu.

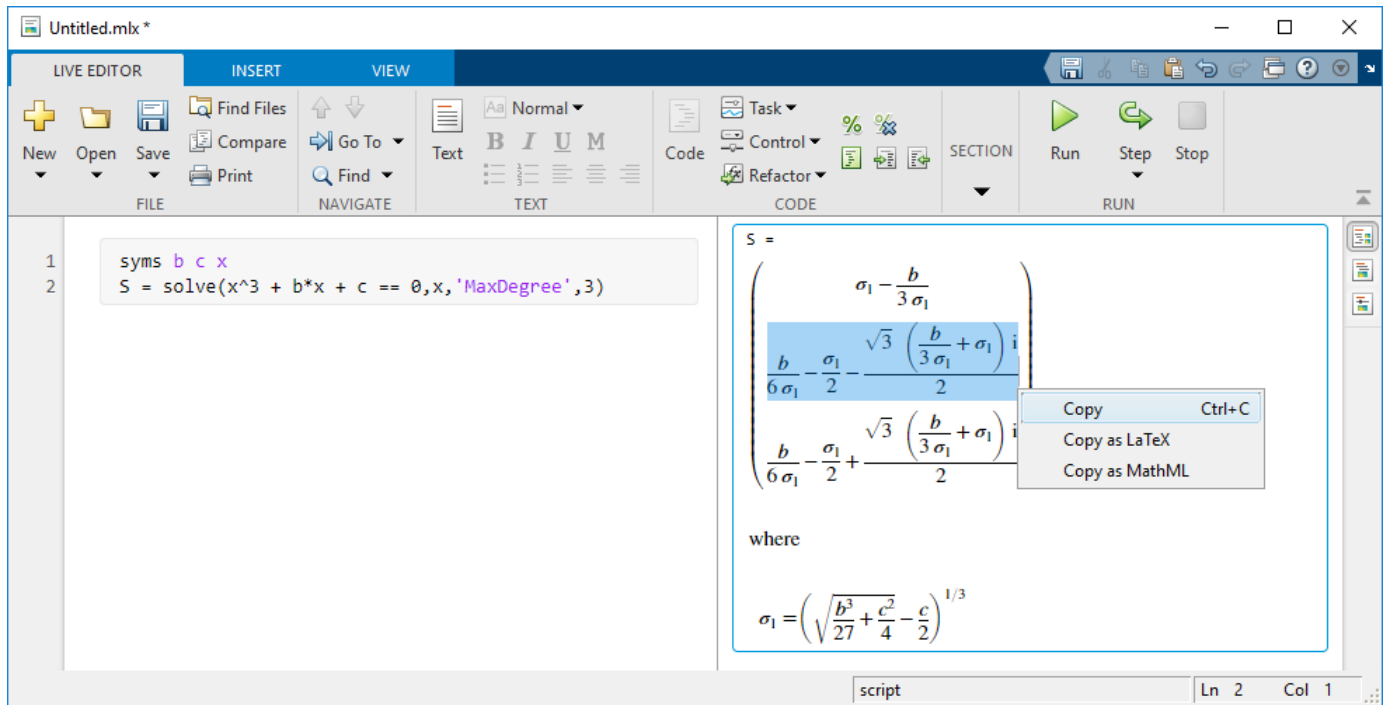

Then paste the selection as equation typeset in the live script using **Ctrl + V** (or right-click and select **Paste**). The equation typeset is rendered as an editable equation. Note that when you paste the output as equation typeset, abbreviated expressions are not expanded.

$$\frac{b}{6\sigma_1} - \frac{\sigma_1}{2} - \frac{\sqrt{3}\left(\frac{b}{3\sigma_1} + \sigma_1\right)i}{2}$$

Units of Measurement Tutorial

Use units of measurement with Symbolic Math Toolbox. This page shows how to define units, use units in equations (including differential equations), and verify the dimensions of expressions.

Define and Convert Units

Load units by using `symunit`.

```
u = symunit;
```

Specify a unit by using `u.unit`. For example, specify a distance of 5 meters, a weight of 50 kilograms, and a speed of 10 kilometers per hour. In displayed output, units are placed in square brackets `[]`.

```
d = 5*u.m
w = 50*u.kg
s = 10*u.km/u.hr
```

```
d =
5*[m]
w =
50*[kg]
s =
10*([km]/[h])
```

Tip Use tab expansion to find names of units. Type `u.`, press **Tab**, and continue typing.

Units are treated like other symbolic expressions and can be used in any standard operation or function. Units are not automatically simplified, which provides flexibility. Common alternate names for units are supported. Plurals are not supported.

Add 500 meters and 2 kilometers. The resulting distance is not automatically simplified.

```
d = 500*u.m + 2*u.km
```

```
d =
2*[km] + 500*[m]
```

Simplify `d` by using `simplify`. The `simplify` function automatically chooses the unit to simplify to.

```
d = simplify(d)
```

```
d =
(5/2)*[km]
```

Instead of automatically choosing a unit, convert `d` to a specific unit by using `unitConvert`. Convert `d` to meters.

```
d = unitConvert(d,u.m)
```

```
d =
2500*[m]
```

There are more unit conversion and unit system options. See “Unit Conversions and Unit Systems” on page 2-39.

Find the speed if the distance d is crossed in 50 seconds. The result has the correct units.

```
t = 50*u.s;
s = d/t

s =
50*([m]/[s])
```

Use Temperature Units in Absolute or Difference Forms

By default, temperatures are assumed to represent differences and not absolute measurements. For example, $5*u.Celsius$ is assumed to represent a temperature difference of 5 degrees Celsius. This assumption allows arithmetical operations on temperature values.

To represent absolute temperatures, use kelvin, so that you do not have to distinguish an absolute temperature from a temperature difference.

Convert 23 degrees Celsius to kelvin, treating it first as a temperature difference and then as an absolute temperature.

```
u = symunit;
T = 23*u.Celsius;
diffK = unitConvert(T,u.K)

diffK =
23*[K]

absK = unitConvert(T,u.K,'Temperature','absolute')

absK =
(5923/20)*[K]
```

Verify Dimensions

In longer expressions, visually checking for units is difficult. You can check the dimensions of expressions automatically by verifying the dimensions of an equation.

First, define the kinematic equation $v^2 = v_0^2 + 2as$, where v represents velocity, a represents acceleration, and s represents distance. Assume s is in kilometers and all other units are in SI base units. To demonstrate dimension checking, the units of a are intentionally incorrect.

```
syms v v0 a s
u = symunit;
eqn = (v*u.m/u.s)^2 == (v0*u.m/u.s)^2 + 2*a*u.m/u.s*s*u.km

eqn =
v^2*([m]^2/[s]^2) == v0^2*([m]^2/[s]^2) + (2*a*s)*([km]*[m])/[s]
```

Observe the units that appear in `eqn` by using `findUnits`. The returned units show that both kilometers and meters are used to represent distance.

```
findUnits(eqn)
```



```
ans =
 [ [km], [m], [s]]
```

Check if the units have the same dimensions (such as length or time) by using `checkUnits` with the 'Compatible' input. MATLAB assumes symbolic variables are dimensionless. `checkUnits` returns logical 0 (false), meaning the units are incompatible and not of the same physical dimensions.

```
checkUnits(eqn, 'Compatible')
```

```
ans =
 logical
 0
```

Looking at `eqn`, the acceleration `a` has incorrect units. Correct the units and recheck for compatibility again. `eqn` now has compatible units.

```
eqn = (v*u.m/u.s)^2 == (v0*u.m/u.s)^2 + 2*a*u.m/u.s^2*s*u.km;
checkUnits(eqn, 'Compatible')
```

```
ans =
 logical
 1
```

Now, to check that each dimension is consistently represented by the same unit, use `checkUnits` with the 'Consistent' input. `checkUnits` returns logical 0 (false) because meters and kilometers are both used to represent distance in `eqn`.

```
checkUnits(eqn, 'Consistent')
```

```
ans =
 logical
 0
```

Convert `eqn` to SI base units to make the units consistent. Run `checkUnits` again. `eqn` has both compatible and consistent units.

```
eqn = unitConvert(eqn, 'SI')
```

```
eqn =
 v^2*([m]^2/[s]^2) == v0^2*([m]^2/[s]^2) + (2000*a*s)*([m]^2/[s]^2)
```

```
checkUnits(eqn)
```

```
ans =
 struct with fields:
    Consistent: 1
    Compatible: 1
```

After you finish working with units and only need the dimensionless equation or expression, separate the units and the equation by using `separateUnits`.

```
[eqn,units] = separateUnits(eqn)
```

```
eqn =
 v^2 == v0^2 + 2000*a*s
units =
 1*([m]^2/[s]^2)
```

You can return the original equation with units by multiplying `eqn` with `units` and expanding the result.

```
expand(eqn*units)
```

```
ans =
v^2*([m]^2/[s]^2) == v0^2*([m]^2/[s]^2) + (2000*a*s)*([m]^2/[s]^2)
```

To calculate numeric values from your expression, substitute for symbolic variables using `subs`, and convert to numeric values using `double` or `vpa`.

Solve `eqn` for `v`. Then find the value of `v` where `v0 = 5`, `a = 2.5`, and `s = 10`. Convert the result to `double`.

```
v = solve(eqn,v);
v = v(2);          % choose the positive solution
vSol = subs(v,[v0 a s],[5 2.5 10]);
vSol = double(vSol)
```

```
vSol =
    223.6627
```

Use Units in Differential Equations

Use units in differential equations just as in standard equations. This section shows how to use units in differential equations by deriving the velocity relations $v = v_0 + at$ and $v^2 = v_0^2 + 2as$ starting from the definition of acceleration $a = \frac{dv}{dt}$.

Represent the definition of acceleration symbolically using SI units. Given that the velocity `V` has units, `V` must be differentiated with respect to the correct units as `T = t*u.s` and not just `t`.

```
syms V(t) a
u = symunit;
T = t*u.s;          % time in seconds
A = a*u.m/u.s^2;    % acceleration in meters per second
eqn1 = A == diff(V,T)
```

```
eqn1(t) =
a*([m]/[s]^2) == diff(V(t), t)*(1/[s])
```

Because the velocity `V` is unknown and does not have units, `eqn1` has incompatible and inconsistent units.

```
checkUnits(eqn1)
```

```
ans =
struct with fields:
    Consistent: 0
    Compatible: 0
```

Solve `eqn1` for `V` with the condition that the initial velocity is `v0`. The result is the equation $v(t) = v_0 + at$.

```

syms v0
cond = V(0) == v0*u.m/u.s;
eqn2 = V == dsolve(eqn1,cond)

eqn2(t) =
V(t) == v0*([m]/[s]) + a*t*([m]/[s])

```

Check that the result has the correct dimensions by substituting rhs (eqn2) into eqn1 and using `checkUnits`.

```
checkUnits(subs(eqn1,V,rhs(eqn2)))
```

```

ans =
  struct with fields:

    Consistent: 1
    Compatible: 1

```

Now, derive $v^2 = v_0^2 + 2as$. Because velocity is the rate of change of distance, substitute V with the derivative of distance S . Again, given that S has units, S must be differentiated with respect to the correct units as $T = t*u.s$ and not just t .

```

syms S(t)
eqn2 = subs(eqn2,V,diff(S,T))

eqn2(t) =
diff(S(t), t)*(1/[s]) == v0*([m]/[s]) + a*t*([m]/[s])

```

Solve eqn2 with the condition that the initial distance covered is 0. Get the expected form of S by using `expand`.

```

cond2 = S(0) == 0;
eqn3 = S == dsolve(eqn2,cond2);
eqn3 = expand(eqn3)

eqn3(t) =
S(t) == t*v0*[m] + ((a*t^2)/2)*[m]

```

You can use this equation with the units in symbolic workflows. Alternatively, you can remove the units by returning the right side using `rhs`, separating units by using `separateUnits`, and using the resulting unitless expression.

```

[S units] = separateUnits(rhs(eqn3))

S(t) =
(a*t^2)/2 + v0*t

units(t) =
[m]

```

When you need to calculate numeric values from your expression, substitute for symbolic variables using `subs`, and convert to numeric values using `double` or `vpa`.

Find the distance traveled in 8 seconds where $v_0 = 20$ and $a = 1.3$. Convert the result to double.

```

S = subs(S,[v0 a],[20 1.3]);
dist = S(8);
dist = double(dist)

```

```
dist =  
    201.6000
```

See Also

[checkUnits](#) | [findUnits](#) | [isUnit](#) | [newUnit](#) | [separateUnits](#) | [symunit2str](#) | [unitConversionFactor](#) | [unitConvert](#)

More About

- “Unit Conversions and Unit Systems” on page 2-39
- “Units and Unit Systems List” on page 2-25

External Websites

- [The International System of Units \(SI\)](#)

Units and Unit Systems List

List of units, SI unit prefixes, and unit systems in Symbolic Math Toolbox. For details, see “Units of Measurement Tutorial” on page 2-19. Common alternate names for units are supported and map to the names listed here. Plurals are not supported.

In this section...
“Units List” on page 2-25
“SI Unit Prefixes List” on page 2-35
“Unit Systems List” on page 2-36
“Defining Constants of SI Units” on page 2-37

Units List

Length

- Ao - angstrom
- a_0 - Bohr radius
- au - astronomical unit
- ch - chain
- ft - foot
- ft_US - U.S. survey foot
- fth - fathom
- fur - furlong
- gg - gauge
- hand - hand
- in - inch
- inm - international nautical mile
- land - league
- li - link
- line - line
- ly - light-year
- m - meter (SI)
- mi - mile
- mi_US - U.S. survey mile
- mil - mil
- nmile - British imperial nautical mile
- pc - parsec
- pica - pica
- pica_US - U.S. customary pica
- pt - point

- `pt_US` - U.S. customary point
- `rod` - rod
- `span` - span
- `xu` - x unit
- `xu_Cu` - x unit (copper)
- `xu_Mo` - x unit (molybdenum)
- `yd` - yard

Mass

- `Mt` - metric megaton
- `ct` - carat
- `cwt` - U.S. customary short hundredweight
- `cwt_UK` - British imperial short hundredweight
- `dalton` - atomic mass constant
- `dr` - dram
- `g` - gram (SI)
- `gr` - grain
- `hyl` - hyl
- `kt` - metric kiloton
- `lbm` - pound mass
- `m_e` - electron mass
- `m_p` - proton mass
- `m_u` - atomic mass constant
- `oz` - ounce
- `quarter` - quarter
- `slug` - slug
- `stone` - stone
- `t` - metric ton
- `tn` - U.S. customary short ton
- `ton_UK` - British imperial ton

Time

- `d` - day
- `fortnight` - 14 days
- `h` - hour
- `min` - minute
- `month_30` - 30-day month
- `s` - second (SI)
- `week` - 7-day week
- `year_360` - 360-day year

- year_Julian - Julian year
- year_Gregorian - Gregorian year

Absorbed Dose or Dose Equivalent

- Gy - gray (SI)
- Rad - absorbed radiation dose
- Sv - sievert (SI)
- rem - roentgen equivalent man

Acceleration

- Gal - gal
- g_n - earth gravitational acceleration

Activity

- Bq - becquerel (SI)
- Ci - curie

Amount of Substance

- item - number of items
- mol - mole (SI)
- molecule - number of molecules

Angular Momentum

- Nms - newton meter second
- \hbar - reduced Planck constant
- h_c - Planck constant

Area

- a - are
- ac - acre
- ac_US - U.S. survey acre
- barn - barn
- circ_mil - circular mil
- circ_inch - circular inch
- ha - metric hectare
- ha_US - U.S. survey hectare
- ro - rood
- twp - township

Capacitance

- F - farad (SI)

- abF - abfarad
- statF - statfarad

Capacitance Per Length

- ϵ_0 - vacuum electric permittivity or electric constant

Catalytic Activity

- kat - katal (SI)

Conductance

- G_0 - conductance quantum
- S - siemens (SI)
- abS - absiemens
- statS - statsiemens

Data Transfer Rate

- Bd - baud
- bps - bit per second

Digital Information

- B - byte
- bit - basic unit of information

Dose Equivalent

- Sv - sievert (SI)

Dynamic Viscosity

- P - poise
- reyn - reynolds

Electric Charge

- C - coulomb (SI)
- Fr - franklin
- abC - abcoulomb
- e - elementary charge
- statC - statcoulomb

Electric Charge Per Mole of Electrons

- F_c - Faraday constant

Electric Current

- A - ampere (SI)

- Bi - biot
- abA - abampere
- statA - statampere

Electric Dipole Moment

- debye - debye

Electric Potential or Electromotive Force

- V - volt (SI)
- abV - abvolt
- statV - statvolt

Energy or Work or Heat

- Btu_IT - British thermal unit (International Table)
- Btu_th - British thermal unit (thermochemical)
- E_h - Hartree energy
- J - joule (SI)
- Nm - newton meter
- Wh - watt hour
- Ws - watt second
- cal_4 - calorie (4 degree Celsius)
- cal_20 - calorie (20 degree Celsius)
- cal_15 - calorie (15 degree Celsius)
- cal_IT - calorie (International Table)
- cal_th - calorie (thermochemical)
- cal_mean - calorie (mean)
- eV - electronvolt
- erg - erg
- kcal_4 - kilocalorie (4 degree Celsius)
- kcal_20 - kilocalorie (20 degree Celsius)
- kcal_15 - kilocalorie (15 degree Celsius)
- kcal_IT - kilocalorie (International Table)
- kcal_th - kilocalorie (thermochemical)
- kcal_mean - kilocalorie (mean)
- kpm - kilopond meter
- therm - therm

Energy Per Temperature

- k_B - Boltzmann constant

Energy Per Temperature Per Amount of Substance

- R_c - molar gas constant

European Currency

- Cent - cent
- EUR - Euro

Magnetic Field Strength

- Oe - oersted

Flow Rate

- gpm - U.S. customary gallon per minute
- gpm_UK - British imperial gallon per minute
- lpm - liter per minute

Force

- N - newton (SI)
- dyn - dyne
- kgf - kilogram force
- kip - kip
- kp - kilopond
- lbf - pound force
- ozf - ounce force
- p - pond
- pdl - poundal
- sn - sthene
- tonf - short ton force

Former European Currency

- ATS - Austrian Schilling
- BEF - Belgian Franc
- DM - German Mark
- ESP - Spanish Peseta
- FIM - Finnish Markka
- FRF - French Franc
- IEP - Irish Pound
- ITL - Italian Lire
- LUF - Luxembourgian Franc
- NLG - Dutch Gulden
- PTE - Portuguese Escudo

Frequency

- Hz - hertz (SI)
- ν_{Cs} - caesium hyperfine transition frequency

Frequency of Rotation

- rpm - revolution per minute
- rps - revolution per second

Fuel Consumption

- $l_{100\text{km}}$ - liter per 100 km

Fuel Economy

- mpg - mile per gallon

Gravity

- G_{c} - Newtonian constant of gravitation

Illuminance

- lx - lux (SI)
- nx - nox
- ph - phot

Inductance

- H - henry (SI)
- abH - abhenry
- statH - stathenry

Inductance Per Length

- μ_0 - vacuum magnetic permeability

Intensity Per Fourth Power of Absolute Temperature

- σ - Stefan-Boltzmann constant

Ionising Dosage

- R - roentgen

Kinematic Viscosity

- St - stokes
- newt - newt

Luminance

- asb - apostilb

- sb - stilb

Luminous Efficacy

- K_{cd} - luminous efficacy of a defined visible radiation

Luminous Flux

- lm - lumen (SI)

Luminous Intensity

- cd - candela (SI)
- cp - candlepower

Magnetic Flux

- Mx - maxwell
- Wb - weber (SI)
- abWb - abweber
- statWb - statweber
- phi_0 - magnetic flux quantum

Magnetic Flux Density

- G - gauss
- T - tesla (SI)
- abT - abtesla
- statT - stattesla

Magnetic Force

- Gb - gilbert

Mass Per Length

- den - denier
- tex - filament tex

Particle Per Amount of Substance

- N_A - Avogadro constant

Plane Angle

- arcsec - arcsecond
- arcmin - arcminute
- deg - degree
- rad - radian (SI)
- rev - revolution

Power or Heat Flow Rate

- HP_E - electrical horsepower
- HP_I - mechanical horsepower
- HP_UK - British imperial horsepower
- HP_DIN - metric horsepower (DIN 66036)
- PS_SAE - net horsepower (SAE J1349)
- PS_DIN - horsepower (DIN 70020)
- W - watt (SI)
- poncelet - poncelet

Pressure or Stress

- Ba - barye
- Pa - pascal (SI)
- Torr - torr
- at - technical atmosphere
- atm - standard atmosphere
- bar - bar
- cmHg - centimeter of mercury (conventional)
- cmH₂O - centimeter of water (conventional)
- ftHg - foot of mercury (conventional)
- ftH₂O - foot of water (conventional)
- inHg - inch of mercury (conventional)
- inH₂O - inch of water (conventional)
- ksf - kip per square foot
- ksi - kip per square inch
- mH₂O - meter of water (conventional)
- mHg - meter of mercury (conventional)
- mmHg - millimeter of mercury (conventional)
- mmH₂O - millimeter of water (conventional)
- psf - pound force per square foot
- psi - pound force per square inch
- pz - pieze

Radiation

- lan - langley

Reciprocal Length

- kayser - kayser
- R_{inf} - Rydberg constant

Refractive Power of Lenses

- dpt - diopter

Resistance

- Ohm - ohm (SI)
- abOhm - abohm
- statOhm - statohm

Solid Angle

- sr - steradian (SI)

Substance Per Volume

- molarity - molarity

Temperature

- Celsius - degree Celsius (SI)
- Fahrenheit - degree Fahrenheit
- K - kelvin (SI)
- Rankine - degree Rankine
- Reaumur - degree Reaumur

Velocity

- Kyne - kyne
- c_0 - speed of light in vacuum
- fpm - foot per minute
- fps - foot per second
- kmh - kilometer per hour
- knot_UK - British imperial knot
- kts - international knot
- mach - speed of sound
- mph - mile per hour

Volume

- barrel - barrel
- bbl - U.S. customary dry barrel
- bu_UK - British imperial bushel
- chaldron - chaldron
- dry_bu - U.S. customary dry bushel
- dry_gal - U.S. customary dry gallon
- dry_pk - U.S. customary dry peck

- `dry_pt` - U.S. customary dry pint
- `dry_qt` - U.S. customary dry quart
- `fldr` - U.S. customary fluid dram
- `fldr_UK` - British imperial fluid drachm (dram)
- `floz` - U.S. customary fluid ounce
- `floz_UK` - British imperial fluid ounce
- `gal` - U.S. customary liquid gallon
- `gal_UK` - British imperial gallon
- `gill` - U.S. customary fluid gill
- `gill_UK` - British imperial gill
- `igal` - British imperial gallon
- `l` - liter
- `liq_pt` - U.S. customary liquid pint
- `liq_qt` - U.S. customary liquid quart
- `minim` - U.S. customary minim
- `minim_UK` - British imperial minim
- `pint` - U.S. customary liquid pint
- `pint_UK` - British imperial pint
- `pk_UK` - British imperial peck
- `pottle` - British imperial pottle
- `qt_UK` - British imperial quart
- `quart` - U.S. customary liquid quart

SI Unit Prefixes List

SI unit prefixes in Symbolic Math Toolbox. Every unit marked by *SI* in the units list accepts SI prefixes. For example, `m` accepts `nm`, `mcm`, `mm`, `cm`, `km` and so on.

Prefix	Input Forms	Example using meters <code>u.m</code> where <code>u = symunit</code>
Yotta 10^{24}	Y, yotta	<code>u.Ym</code> , <code>u.yottam</code>
Zetta 10^{21}	Z, zetta	<code>u.Zm</code> , <code>u.zettam</code>
Exa 10^{18}	E, exa	<code>u.Em</code> , <code>u.exam</code>
Peta 10^{15}	P, peta	<code>u.Pm</code> , <code>u.petam</code>
Tera 10^{12}	T, tera	<code>u.Tm</code> , <code>u.teram</code>
Giga 10^9	G, giga	<code>u.gigam</code> , <code>u.Gm</code>
Mega 10^6	M, mega	<code>u.Mm</code> , <code>u.megam</code>
Kilo 10^3	k, kilo	<code>u.km</code> , <code>u.kilom</code>
Hecto 10^2	h, hecto	<code>u.hm</code> , <code>u.hectom</code>
Deka 10^1	da, deka, deca	<code>u.dam</code> , <code>u.dekam</code> , <code>u.decam</code>

Prefix	Input Forms	Example using meters u.m where u = symunit
Deci 10 ⁻¹	d, deci	u.dm, u.decim
Centi 10 ⁻²	c, centi	u.cm, u.centim
Milli 10 ⁻³	m, milli	u.mm, u.millim
Micro 10 ⁻⁶	mc, micro, u	u.mcm, u.microm, u.um
Nano 10 ⁻⁹	n, nano	u.nm, u.nanom
Pico 10 ⁻¹²	p, pico	u.pm, u.picom
Femto 10 ⁻¹⁵	f, femto	u.fm, u.femtom
Atto 10 ⁻¹⁸	a, atto	u.am, u.attom
Zepto 10 ⁻²¹	z, zepto	u.zm, u.zeptom
Yocto 10 ⁻²⁴	y, yocto	u.ym, u.yoctom

Unit Systems List

Available unit systems in Symbolic Math Toolbox are listed below. For details, see “Unit Conversions and Unit Systems” on page 2-39.

Unit System	Base Units	Derived Units
SI units ('SI')	baseUnits('SI') ans = [[kg], [s], [m], [A], [cd], [K], [mol], [C]]	derivedUnits('SI') ans = [[mF], [K], [S], [H], [V], [J], [N], [lbf], [Pa], [Ohm], [T], [Gy], [Bq], [Sv], [H], [Celsius]]
CGS units ('CGS')	baseUnits('CGS') ans = [[cm], [g], [s], [K]]	derivedUnits('CGS') ans = [[Gal], [dyn], [erg], [Ba], [P], [St], [statH], [statS], [statOhm], [statT], [statV], [statVolt], [statW], [statWatt]]
US units ('US')	baseUnits('US') ans = [[lbm], [s], [ft], [A], [cd], [K], [mol], [C]]	derivedUnits('US') ans = [[mF], [K], [S], [H], [V], [J], [N], [lbf], [Pa], [Ohm], [T], [Gy], [Bq], [Sv], [H], [Celsius], [Btu_IT], [W], [psf], [sr], [Fahrenheit], [gal]]
Electrostatic units ('ESU')	baseUnits('ESU') ans = [[cm], [g], [s], [K], [statC]]	derivedUnits('ESU') ans = [[mF], [K], [S], [H], [V], [J], [N], [lbf], [Pa], [Ohm], [T], [Gy], [Bq], [Sv], [H], [Celsius], [statH], [statS], [statOhm], [statT], [statV], [statW], [statWatt]]
Gaussian units ('GU')	baseUnits('GU') ans = [[cm], [g], [s], [K], [Fr]]	derivedUnits('GU') ans = [[mF], [K], [S], [H], [V], [J], [N], [lbf], [Pa], [Ohm], [T], [Gy], [Bq], [Sv], [H], [Celsius], [Bi], [Mx], [Oe], [debye]]

See Also

Related Examples

- “Units of Measurement Tutorial” on page 2-19
- “Unit Conversions and Unit Systems” on page 2-39

External Websites

- The International System of Units (SI)

Unit Conversions and Unit Systems

Convert between units with Symbolic Math Toolbox. This page shows conversions between units and between systems of units, such as SI, CGS, or a user-defined unit system.

Convert Units

Convert between units by using `unitConvert`.

Convert 1.2 meters to centimeters.

```
u = symunit;
len = 1.2*u.m;
len = unitConvert(len,u.cm)
```

```
len =
120*[cm]
```

Convert `len` to inches. The result is in exact symbolic form. Separate units and convert to double.

```
len = unitConvert(len,u.in)
```

```
len =
(6000/127)*[in]
```

```
[len units] = separateUnits(len);
len = double(len)
```

```
len =
47.2441
```

Calculate the force needed to accelerate a mass of 5 kg at 2 m/s².

```
m = 5*u.kg;
a = 2*u.m/u.s^2;
F = m*a
```

```
F =
10*([kg]*[m])/[s]^2)
```

Convert the result to newton.

```
F = unitConvert(F,u.N)
```

```
F =
10*[N]
```

Tip Use tab expansion to find names of units. Type `u.`, press **Tab**, and continue typing.

Calculate the energy when force `F` is applied for 3 meters. Convert the result to joule.

```
d = 3*u.m;
E = F*d
```

```
E =
30*[N]*[m]
```

```
E = unitConvert(E,u.J)
```

```
E =  
30*[J]
```

Convert E to kilowatt-hour.

```
E = unitConvert(E,u.kWh)
```

```
E =  
(1/120000)*[kWh]
```

Temperature Unit Conversion

Temperatures can represent either absolute temperatures or temperature differences. By default, temperatures are assumed to be differences. Convert temperatures assuming temperatures are absolute by specifying the 'Temperature' input as 'absolute'.

Convert 23 degrees Celsius to degrees Kelvin, first as a temperature difference and then as an absolute temperature.

```
u = symunit;  
T = 23*u.Celsius;  
relK = unitConvert(T,u.K,'Temperature','difference')
```

```
relK =  
23*[K]
```

```
absK = unitConvert(T,u.K,'Temperature','absolute')
```

```
absK =  
(5923/20)*[K]
```

Because the value 0 is dimensionless and 0 degrees cannot be represented, convert 0 degrees between temperature units by using cell input.

Convert 0 degrees Celsius to degrees Fahrenheit.

```
tC = {0,u.Celsius};  
tF = unitConvert(tC,u.Fahrenheit,'Temperature','Absolute')
```

```
tF =  
32*[Fahrenheit]
```

Convert to SI, CGS, or US Unit Systems

Automatically convert to the correct units by converting to a unit system. Further, converting to the *derived* units of a unit system attempts to select convenient units. Available unit systems include SI, CGS, and US. For all unit systems, see "Unit Systems List" on page 2-36. In addition, you can define custom unit systems.

Calculate the force due to a 5 kg mass accelerating at 2 m/s². The resulting units are hard to read. Convert them to convenient units by specifying the SI and Derived options. `unitConvert` automatically chooses the correct units of newton.

```
u = symunit;  
m = 5*u.kg;
```

```
a = 2*u.m/u.s^2;
F = m*a
```

```
F =
10*([kg]*[m])/[s]^2)
```

```
F = unitConvert(F,'SI','Derived')
```

```
F =
10*[N]
```

Convert F to US units. By default, the converted units are base units. For convenience, also convert into derived units by specifying the `Derived` option. The derived units are easier to read.

```
F = unitConvert(F,'US')
```

```
F =
(1250000000000/17281869297)*([ft]*[lbm])/[s]^2)
```

```
F = unitConvert(F,'US','Derived')
```

```
F =
(2000000000000/8896443230521)*[lbf]
```

Convert F to CGS derived units.

```
F = unitConvert(F,'CGS','Derived')
```

```
F =
1000000*[dyn]
```

Convert a specification in SI to US derived units. Specify the temperatures as absolute.

```
loadCell = [ 3*u.kg;      % capacity
            50*u.mm;     % length
            15*u.mm;     % width
            10*u.mm;     % height
            -10*u.Celsius; % minimum temperature
            40*u.Celsius; % maximum temperature
            ];
```

```
loadCell = unitConvert(loadCell,'US','derived','Temperature','absolute')
```

```
loadCell =
(3000000000/45359237)*[lbm]
(125/762)*[ft]
(25/508)*[ft]
(25/762)*[ft]
14*[Fahrenheit]
104*[Fahrenheit]
```

If `unitConvert` does not choose your preferred unit, then adjust the result with further `unitConvert` commands. Here, inches are more convenient than feet. Convert the result to inches.

```
loadCell = unitConvert(loadCell,u.inch)
```

```
loadCell =
(3000000000/45359237)*[lbm]
(250/127)*[in]
(75/127)*[in]
(50/127)*[in]
```

```

14*[Fahrenheit]
104*[Fahrenheit]

```

The exact symbolic values are hard to read. Separate the units and convert to double.

```

[loadCellDouble loadCellUnits] = separateUnits(loadCell);
loadCellDouble = double(loadCellDouble)

```

```

loadCellDouble =
    6.6139
    1.9685
    0.5906
    0.3937
   14.0000
  104.0000

```

Alternatively, approximate the result to high precision by using `vpa`. The `vpa` function also keeps the symbolic units because it returns symbolic output.

```

loadCell = vpa(loadCell)

loadCell =
 6.6138678655463274216892140403508*[lbm]
 1.968503937007874015748031496063*[in]
 0.5905511811023622047244094488189*[in]
 0.3937007874015748031496062992126*[in]
          14.0*[Fahrenheit]
          104.0*[Fahrenheit]

```

Convert five acres (ac), whose unit is a U.S. survey acre, to metric area.

```

u = symunit;
area = 5*u.ac_US;
area = unitConvert(area, 'SI')

area =

(313632000000/15499969)*[m]^2

```

Define Custom Unit System from Existing System

Custom unit systems provide flexibility in converting units. You can easily define a custom unit system by modifying a default unit system. Alternatively, you can define the system directly. For definitions of unit system, base units, and derived units, see “Unit System Definition” on page 2-44.

In photonics, commonly used units are nanosecond (ns), electron volt (eV), and nanometer (nm). Define a unit system with these units by modifying the SI unit system. Get SI base and derived units by using `baseUnits` and `derivedUnits`. Modify the units by using `subs`.

```

u = symunit;
bunits = baseUnits('SI');
bunits = subs(bunits,[u.m u.s],[u.nm u.ns])

bunits =
[ [kg], [ns], [nm], [A], [cd], [mol], [K]]

dunits = derivedUnits('SI');
dunits = subs(dunits,u.J,u.eV)

```

```
dunits =
[ [F], [C], [S], [H], [V], [eV], [N], [lx], [lm], [Wb], [W], [Pa],...
  [Ohm], [T], [Gy], [Bq], [Sv], [Hz], [kat], [rad], [sr], [Celsius]]
```

Note Do not define variables called `baseUnits` and `derivedUnits` because the variables prevent access to the `baseUnits` and `derivedUnits` functions.

Define the new unit system by using `newUnitSystem`.

```
phSys = newUnitSystem('photonics',bunits,dunits)
```

```
phSys =
  "photonics"
```

Calculate the energy of a photon of frequency 1 GHz and convert the result to derived units of the `phSys` system. The result is in electron volts.

```
f = 1*u.GHz;
E = u.h_c*f;
E = unitConvert(E,phSys,'Derived')
```

```
E =
(44173801/10681177560000)*[eV]
```

The exact symbolic result is hard to read. Separate the units and convert to double.

```
[E Eunits] = separateUnits(E);
E = double(E)
```

```
E =
  4.1357e-06
```

After completing calculations, remove the unit system.

```
removeUnitSystem(phSys)
```

Define Custom Unit System Directly

Define a custom unit system for atomic units (au).

Define these base units:

Dimension	Unit	Implementation
Mass	Electron rest mass	<code>u.m_e</code>
Elementary charge	Electron charge	<code>u.e</code>
Length	Bohr radius (a_0)	<code>u.Bohr</code>
Time	\hbar/E_h	Define by using <code>newUnit</code> .

```
u = symunit;
t_au = newUnit('t_au',u.hbar/u.E_h);
bunits = [u.m_e u.e u.Bohr u.t_au]
```

```
bunits =
[ [m_e], [e], [a_0], [t_au]]
```

Define these derived units:

Dimension	Unit	Implementation
Angular momentum	Reduced Planck's constant	<code>u.hbar</code>
Energy	Hartree	<code>u.E_h</code>
Electric dipole moment	ea_0	Define by using <code>newUnit</code> .
Magnetic dipole moment	2 Bohr magneton = $e\hbar/2m_e$	Define by using <code>newUnit</code> .
Electric potential	E_h/e	Define by using <code>newUnit</code> .

```
edm_au = newUnit('edm_au',u.e*u.bohr);
mdm_au = newUnit('mdm_au', u.e*u.hbar/(2*u.me));
ep_au = newUnit('ep_au', u.E_h/u.e);
dunits = [u.hbar u.E_h u.edm_au u.mdm_au u.ep_au]
```

```
dunits =
[ [h_bar], [E_h], [edm_au], [mdm_au], [ep_au]]
```

Define the unit system.

```
auSys = newUnitSystem('atomicUnits',bunits,dunits)
auSys =
"atomicUnits"
```

Convert the properties of a proton to atomic units.

```
proton = [ 1.672621923e-27*u.kg;      % mass
           1.6021766208e-19*u.C;      % charge
           5.4e-24*u.e*u.cm;          % electric dipole moment
           1.4106067873e-26*u.J/u.T;  % magnetic dipole moment
         ];
proton = unitConvert(proton,auSys,'Derived')

proton =
           1836.1526726825404620381265471117*[m_e]
           0.99999999176120807953267071600981*[e]
0.000000000000000010204521072979158730257341288851*[edm_au]
           0.00048415958374162452452052339364507*pi*[mdm_au]
```

After completing calculations, remove the unit system and the added units.

```
removeUnitSystem(auSys)
removeUnit([u.t_au u.edm_au u.mdm_au u.ep_au])
```

Unit System Definition

A unit system is a collection of base units and derived units that follows these rules:

- Base units must be independent in terms of the dimensions mass, time, length, electric current, luminous intensity, amount of substance, and temperature. Therefore, a unit system has up to 7 base units. As long as the independence is satisfied, any unit can be a base unit, including units such as newton or watt.
- A unit system can have less than 7 base units. For example, mechanical systems need base units only for the dimensions length, mass, and time.

- Derived units in a unit system must have a representation in terms of the products of powers of the base units for that system. Unlike base units, derived units do not have to be independent.
- Derived units are optional and added for convenience of representation. For example, kg m/s^2 is abbreviated by newton.
- An example of a unit system is the SI unit system, which has 7 base units: kilogram, second, meter, ampere, candela, mol, and kelvin. There are 22 derived units found by calling `derivedUnits('SI')`.

See Also

`baseUnits` | `derivedUnits` | `newUnitSystem` | `removeUnit` | `removeUnitSystem` | `symunit` | `unitConvert`

More About

- “Units of Measurement Tutorial” on page 2-19
- “Units and Unit Systems List” on page 2-25

External Websites

- The International System of Units (SI)

Differentiation

To illustrate how to take derivatives using Symbolic Math Toolbox software, first create a symbolic expression:

```
syms x
f = sin(5*x);
```

The command

```
diff(f)
```

differentiates f with respect to x :

```
ans =
5*cos(5*x)
```

As another example, let

```
g = exp(x)*cos(x);
```

where $\exp(x)$ denotes e^x , and differentiate g :

```
y = diff(g)
y =
exp(x)*cos(x) - exp(x)*sin(x)
```

To find the derivative of g for a given value of x , substitute x for the value using `subs` and return a numerical value using `vpa`. Find the derivative of g at $x = 2$.

```
vpa(subs(y,x,2))
ans =
-9.7937820180676088383807818261614
```

To take the second derivative of g , enter

```
diff(g,2)
ans =
-2*exp(x)*sin(x)
```

You can get the same result by taking the derivative twice:

```
diff(diff(g))
ans =
-2*exp(x)*sin(x)
```

In this example, MATLAB software automatically simplifies the answer. However, in some cases, MATLAB might not simplify an answer, in which case you can use the `simplify` command. For an example of such simplification, see “More Examples” on page 2-48.

Note that to take the derivative of a constant, you must first define the constant as a symbolic expression. For example, entering

```
c = sym('5');
diff(c)
```

returns

```
ans =
0
```

If you just enter

```
diff(5)
```

MATLAB returns

```
ans =
[]
```

because 5 is not a symbolic expression.

Derivatives of Expressions with Several Variables

To differentiate an expression that contains more than one symbolic variable, specify the variable that you want to differentiate with respect to. The `diff` command then calculates the partial derivative of the expression with respect to that variable. For example, given the symbolic expression

```
syms s t
f = sin(s*t);
```

the command

```
diff(f,t)
```

calculates the partial derivative $\partial f / \partial t$. The result is

```
ans =
s*cos(s*t)
```

To differentiate `f` with respect to the variable `s`, enter

```
diff(f,s)
```

which returns:

```
ans =
t*cos(s*t)
```

If you do not specify a variable to differentiate with respect to, MATLAB chooses a default variable. Basically, the default variable is the letter closest to `x` in the alphabet. See the complete set of rules in “Find a Default Symbolic Variable” on page 2-3. In the preceding example, `diff(f)` takes the derivative of `f` with respect to `t` because the letter `t` is closer to `x` in the alphabet than the letter `s` is. To determine the default variable that MATLAB differentiates with respect to, use `symvar`:

```
symvar(f, 1)
```

```
ans =
t
```

Calculate the second derivative of `f` with respect to `t`:

```
diff(f, t, 2)
```

This command returns

```
ans =
-s^2*sin(s*t)
```

Note that `diff(f, 2)` returns the same answer because `t` is the default variable.

More Examples

To further illustrate the `diff` command, define `a`, `b`, `x`, `n`, `t`, and `theta` in the MATLAB workspace by entering

```
syms a b x n t theta
```

This table illustrates the results of entering `diff(f)`.

f	diff(f)
<pre>syms x n f = x^n;</pre>	<pre>diff(f) ans = n*x^(n - 1)</pre>
<pre>syms a b t f = sin(a*t + b);</pre>	<pre>diff(f) ans = a*cos(b + a*t)</pre>
<pre>syms theta f = exp(i*theta);</pre>	<pre>diff(f) ans = exp(theta*1i)*1i</pre>

To differentiate the Bessel function of the first kind, `besselj(nu, z)`, with respect to `z`, type

```
syms nu z
b = besselj(nu,z);
db = diff(b)
```

which returns

```
db =
(nu*besselj(nu, z))/z - besselj(nu + 1, z)
```

The `diff` function can also take a symbolic matrix as its input. In this case, the differentiation is done element-by-element. Consider the example

```
syms a x
A = [cos(a*x), sin(a*x); -sin(a*x), cos(a*x)]
```

which returns

```
A =
[ cos(a*x), sin(a*x)]
[ -sin(a*x), cos(a*x)]
```

The command

```
diff(A)
```

returns

```
ans =
[ -a*sin(a*x),  a*cos(a*x)]
[ -a*cos(a*x), -a*sin(a*x)]
```

You can also perform differentiation of a vector function with respect to a vector argument. Consider the transformation from Euclidean (x, y, z) to spherical (r, λ, φ) coordinates as given by $x = r\cos\lambda\cos\varphi$, $y = r\cos\lambda\sin\varphi$, and $z = r\sin\lambda$. Note that λ corresponds to elevation or latitude while φ denotes azimuth or longitude.

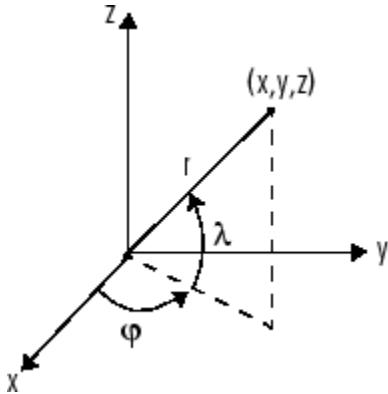

To calculate the Jacobian matrix, J , of this transformation, use the `jacobian` function. The mathematical notation for J is

$$J = \frac{\partial(x, y, z)}{\partial(r, \lambda, \varphi)}.$$

For the purposes of toolbox syntax, use `l` for λ and `f` for φ . The commands

```
syms r l f
x = r*cos(l)*cos(f);
y = r*cos(l)*sin(f);
z = r*sin(l);
J = jacobian([x; y; z], [r l f])
```

return the Jacobian

```
J =
[ cos(f)*cos(l), -r*cos(f)*sin(l), -r*cos(l)*sin(f)]
[ cos(l)*sin(f), -r*sin(f)*sin(l),  r*cos(f)*cos(l)]
[          sin(l),          r*cos(l),          0]
```

and the command

```
detJ = simplify(det(J))
```

returns

```
detJ =
-r^2*cos(l)
```

The arguments of the `jacobian` function can be column or row vectors. Moreover, since the determinant of the Jacobian is a rather complicated trigonometric expression, you can use `simplify` to make trigonometric substitutions and reductions (simplifications).

A table summarizing `diff` and `jacobian` follows.

Mathematical Operator	MATLAB Command
$\frac{df}{dx}$	<code>diff(f)</code> or <code>diff(f, x)</code>
$\frac{df}{da}$	<code>diff(f, a)</code>
$\frac{d^2f}{db^2}$	<code>diff(f, b, 2)</code>
$J = \frac{\partial(r, t)}{\partial(u, v)}$	<code>J = jacobian([r; t],[u; v])</code>

Functional Derivatives Tutorial

This example shows how to use functional derivatives in the Symbolic Math Toolbox™ using the example of the wave equation. This example performs calculations symbolically to obtain analytic results. The wave equation for a string fixed at its ends is solved using functional derivatives. A functional derivative is the derivative of a functional with respect to the function that the functional depends on. The Symbolic Math Toolbox™ implements functional derivatives using the `functionalDerivative` function.

Solving the wave equation is one application of functional derivatives. It describes the motion of waves, from the motion of a string to the propagation of an electromagnetic wave, and is an important equation in physics. You can apply the techniques illustrate in this example to applications in the calculus of variations from solving the Brachistochrone problem to finding minimal surfaces of soap bubbles.

Consider a string of length L suspended between the two points $x = 0$ and $x = L$. The string has a characteristic density per unit length and a characteristic tension. Define the length, density, and tension as constants for later use. For simplicity, set these constants to 1.

```
Length = 1;
Density = 1;
Tension = 1;
```

If the string is in motion, the string's kinetic and potential energies are a function of its displacement from rest $S(x, t)$, which varies with position x and time t . If d is the density per unit length, the kinetic energy is

$$T = \int_0^L \frac{d}{2} \left(\frac{d}{dt} S(x, t) \right)^2 dx.$$

The potential energy is

$$V = \int_0^L \frac{r}{2} \left(\frac{d}{dx} S(x, t) \right)^2 dx,$$

where r is the tension.

Enter these equations in MATLAB®. Since length must be positive, set this assumption. This assumption allows `simplify` to simplify the resulting equations into the expected form.

```
syms S(x,t) d r v L
assume(L>0)
T(x,t) = int(d/2*diff(S,t)^2,x,0,L);
V(x,t) = int(r/2*diff(S,x)^2,x,0,L);
```

The action A is $T - V$. The Principle of Least Action states that action is always minimized. Determine the condition for minimum action, by finding the functional derivative of A with respect to S using `functionalDerivative` and equate it to zero.

```
A = T-V;
eqn = functionalDerivative(A,S) == 0
```

```
eqn(x, t) =
    L r \frac{\partial^2}{\partial x^2} S(x,t) - L d \frac{\partial^2}{\partial t^2} S(x,t) = 0
```

Simplify the equation using `simplify`. Convert the equation into its expected form by substituting for r/d with the square of the wave velocity v .

```
eqn = simplify(eqn)/r;
eqn = subs(eqn,r/d,v^2)
```

$$\text{eqn}(x, t) = \frac{\frac{\partial^2}{\partial t^2} S(x, t)}{v^2} = \frac{\partial^2}{\partial x^2} S(x, t)$$

Solve the equation using the method of separation of variables. Set $S(x, t) = U(x)*V(t)$ to separate the dependence on position x and time t . Separate both sides of the resulting equation using `children`.

```
syms U(x) V(t)
eqn2 = subs(eqn,S(x,t),U(x)*V(t));
eqn2 = eqn2/(U(x)*V(t))
```

$$\text{eqn2}(x, t) = \frac{\frac{\partial^2}{\partial t^2} V(t)}{v^2 V(t)} = \frac{\frac{\partial^2}{\partial x^2} U(x)}{U(x)}$$

```
tmp = children(eqn2);
```

Both sides of the equation depend on different variables, yet are equal. This is only possible if each side is a constant. Equate each side to an arbitrary constant C to get two differential equations.

```
syms C
eqn3 = tmp(1) == C
```

$$\text{eqn3} = \frac{\frac{\partial^2}{\partial t^2} V(t)}{v^2 V(t)} = C$$

```
eqn4 = tmp(2) == C
```

$$\text{eqn4} = \frac{\frac{\partial^2}{\partial x^2} U(x)}{U(x)} = C$$

Solve the differential equations using `dsolve` with the condition that displacement is 0 at $x = 0$ and $t = 0$. Simplify the equations to their expected form using `simplify` with the `Steps` option set to `50`.

```
V(t) = dsolve(eqn3,V(0)==0,t);
U(x) = dsolve(eqn4,U(0)==0,x);
V(t) = simplify(V(t),'Steps',50)
```

$$V(t) = -2 C_1 \sinh(\sqrt{C} t v)$$

```
U(x) = simplify(U(x),'Steps',50)
```

$$U(x) = 2 C_1 \sinh(\sqrt{C} x)$$

Obtain the constants in the equations.

```
p1 = setdiff(symvar(U(x)),sym([C,x]))
p1 = C1
p2 = setdiff(symvar(V(t)),sym([C,v,t]))
p2 = C1
```

The string is fixed at the positions $x = 0$ and $x = L$. The condition $U(0) = 0$ already exists. Apply the boundary condition that $U(L) = 0$ and solve for C .

```
eqn_bc = U(L) == 0;
[soLC,param,cond] = solve(eqn_bc,C,'ReturnConditions',true)
soLC =

$$-\frac{k^2 \pi^2}{L^2}$$

param = k
cond = C1 ≠ 0 ∧ 1 ≤ k ∧ k ∈ ℤ
assume(cond)
```

The solution $S(x, t)$ is the product of $U(x)$ and $V(t)$. Find the solution, and substitute the characteristic values of the string into the solution to obtain the final form of the solution.

```
S(x,t) = U(x)*V(t);
S = subs(S,C,soLC);
S = subs(S,[L v],[Length sqrt(Tension/Density)]);
```

The parameters $p1$ and $p2$ determine the amplitude of the vibrations. Set $p1$ and $p2$ to 1 for simplicity.

```
S = subs(S,[p1 p2],[1 1]);
S = simplify(S,'Steps',50)
S(x, t) = 4 sin(π k t) sin(π k x)
```

The string has different modes of vibration for different values of k . Plot the first four modes for an arbitrary value of time t . Use the `param` argument returned by `solve` to address parameter k .

```
Splot(x) = S(x,0.3);
figure(1)
hold on
grid on
ymin = double(coeffs(Splot));
for i = 1:4
    yplot = subs(Splot,param,i);
    fplot(yplot,[0 Length])
end
ylim([-ymin ymin])
legend('k = 1','k = 2','k = 3','k = 4','Location','best')
xlabel('Position (x)')
ylabel('Displacement (S)')
title('Modes of a string')
```

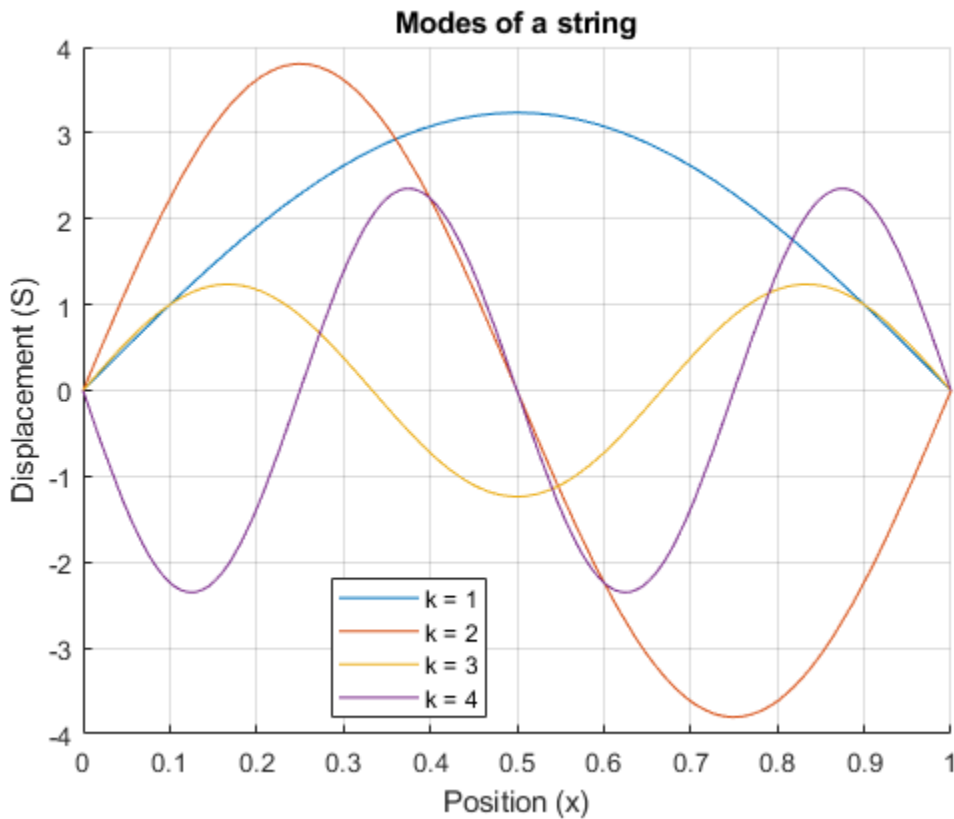

The wave equation is linear. This means that any linear combination of the allowed modes is a valid solution to the wave equation. Hence, the full solution to the wave equation with the given boundary conditions and initial values is a sum over allowed modes

$$F(x, t) = \sum_{k=n}^m A_k \sin(\pi k t) \sin(\pi k x),$$

where A_k denotes arbitrary constants.

Use `symsum` to sum the first five modes of the string. On a new figure, display the resulting waveform at the same instant of time as the previous waveforms for comparison.

```
figure(2)
S5(x) = 1/5*symsum(S,param,1,5);
fplot(subs(S5,t,0.3),[0 Length])
ylim([-ymin ymin])
grid on
xlabel('Position (x)')
ylabel('Displacement (S)')
title('Summation of first 5 modes')
```

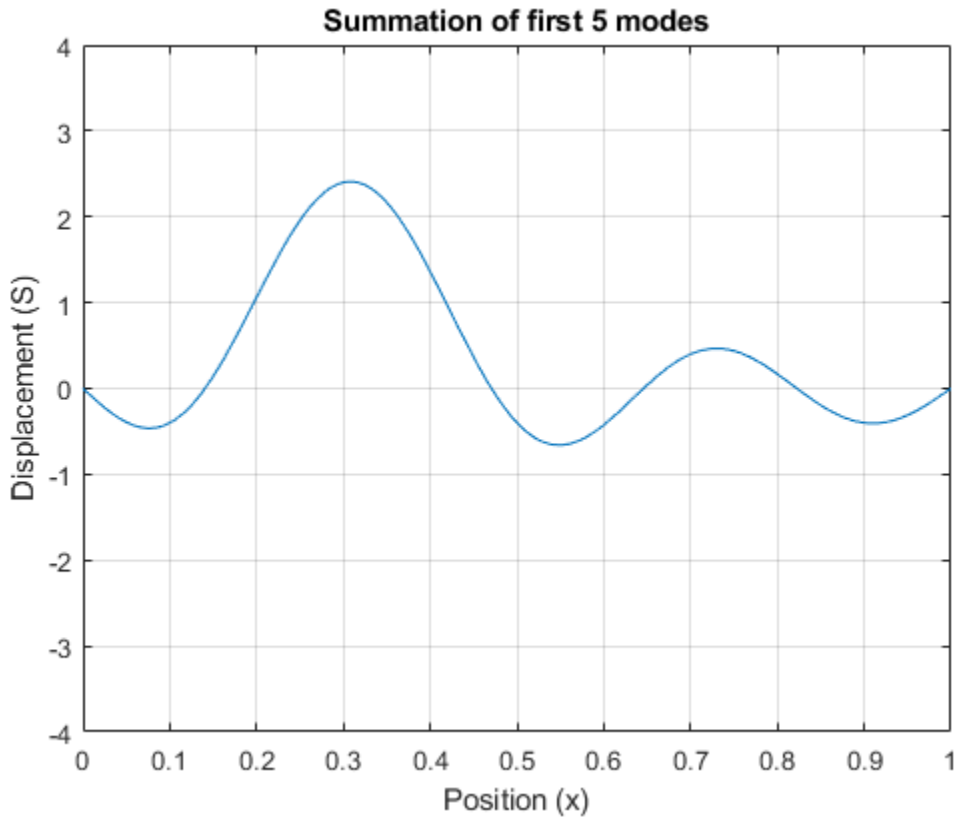

The figure shows that summing modes allows you to model a qualitatively different waveform. Here, we specified the initial condition is $S(x, t = 0) = 0$ for all x .

You can calculate the values A_k in the equation $F(x, t) = \sum_{k=n}^m A_k \sin(\pi kt) \sin(\pi kx)$ by specifying a condition for initial velocity

$$u_t(x, t = 0) = F_t(x, 0).$$

The appropriate summation of modes can represent any waveform, which is the same as using the Fourier series to represent the string's motion.

Limits

The fundamental idea in calculus is to make calculations on functions as a variable “gets close to” or approaches a certain value. Recall that the definition of the derivative is given by a limit

$$f'(x) = \lim_{h \rightarrow 0} \frac{f(x+h) - f(x)}{h},$$

provided this limit exists. Symbolic Math Toolbox software enables you to calculate the limits of functions directly. The commands

```
syms h n x
limit((cos(x+h) - cos(x))/h, h, 0)
```

which return

```
ans =
-sin(x)
```

and

```
limit((1 + x/n)^n, n, inf)
```

which returns

```
ans =
exp(x)
```

illustrate two of the most important limits in mathematics: the derivative (in this case of $\cos(x)$) and the exponential function.

One-Sided Limits

You can also calculate one-sided limits with Symbolic Math Toolbox software. For example, you can calculate the limit of $x/|x|$, whose graph is shown in the following figure, as x approaches 0 from the left or from the right.

```
syms x
fplot(x/abs(x), [-1 1], 'ShowPoles', 'off')
```

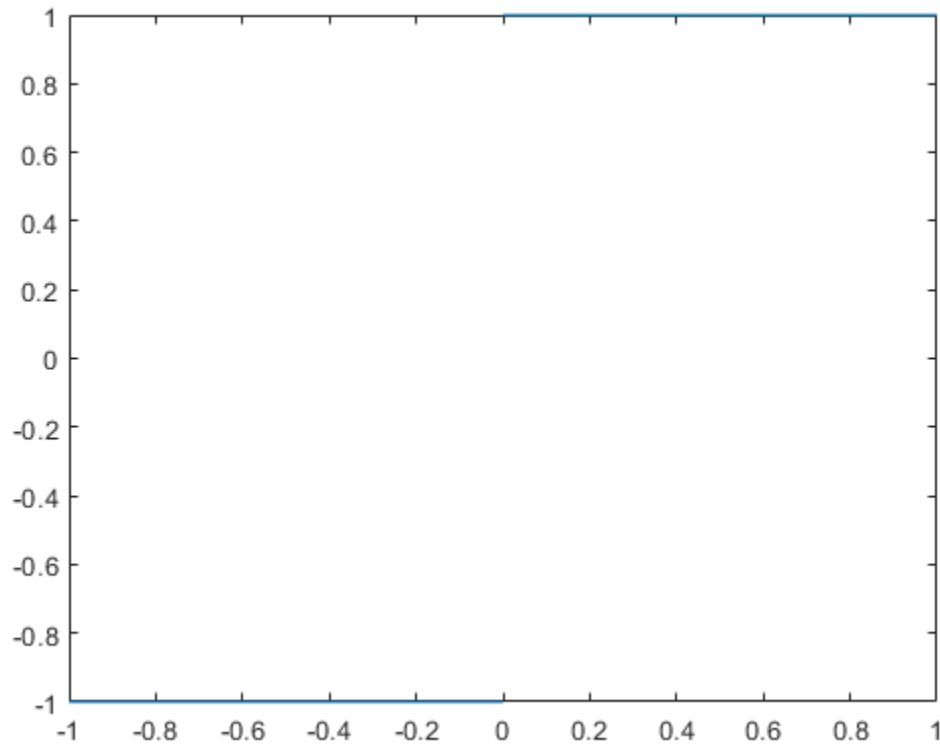

To calculate the limit as x approaches 0 from the left,

$$\lim_{x \rightarrow 0^-} \frac{x}{|x|},$$

enter

```
syms x
limit(x/abs(x), x, 0, 'left')
```

```
ans =
-1
```

To calculate the limit as x approaches 0 from the right,

$$\lim_{x \rightarrow 0^+} \frac{x}{|x|} = 1,$$

enter

```
syms x
limit(x/abs(x), x, 0, 'right')
```

```
ans =
1
```

Since the limit from the left does not equal the limit from the right, the two-sided limit does not exist. In the case of undefined limits, MATLAB returns NaN (not a number). For example,

```
syms x
limit(x/abs(x), x, 0)
```

returns

```
ans =
NaN
```

Observe that the default case, `limit(f)` is the same as `limit(f,x,0)`. Explore the options for the `limit` command in this table, where `f` is a function of the symbolic object `x`.

Mathematical Operation	MATLAB Command
$\lim_{x \rightarrow 0} f(x)$	<code>limit(f)</code>
$\lim_{x \rightarrow a} f(x)$	<code>limit(f, x, a)</code> or <code>limit(f, a)</code>
$\lim_{x \rightarrow a^-} f(x)$	<code>limit(f, x, a, 'left')</code>
$\lim_{x \rightarrow a^+} f(x)$	<code>limit(f, x, a, 'right')</code>

Integration

If f is a symbolic expression, then

```
int(f)
```

attempts to find another symbolic expression, F , so that $\text{diff}(F) = f$. That is, $\text{int}(f)$ returns the indefinite integral or antiderivative of f (provided one exists in closed form). Similar to differentiation,

```
int(f,v)
```

uses the symbolic object v as the variable of integration, rather than the variable determined by `symvar`. See how `int` works by looking at this table.

Mathematical Operation	MATLAB Command
$\int x^n dx = \begin{cases} \log(x) & \text{if } n = -1 \\ \frac{x^{n+1}}{n+1} & \text{otherwise.} \end{cases}$	<code>int(x^n)</code> or <code>int(x^n,x)</code>
$\int_0^{\pi/2} \sin(2x) dx = 1$	<code>int(sin(2*x), 0, pi/2)</code> or <code>int(sin(2*x), x, 0, pi/2)</code>
$g = \cos(at + b)$ $\int g(t) dt = \sin(at + b)/a$	<code>g = cos(a*t + b)</code> <code>int(g)</code> or <code>int(g, t)</code>
$\int J_1(z) dz = -J_0(z)$	<code>int(besselj(1, z))</code> or <code>int(besselj(1, z), z)</code>

In contrast to differentiation, symbolic integration is a more complicated task. A number of difficulties can arise in computing the integral:

- The antiderivative, F , may not exist in closed form.
- The antiderivative may define an unfamiliar function.
- The antiderivative may exist, but the software can't find it.
- The software could find the antiderivative on a larger computer, but runs out of time or memory on the available machine.

Nevertheless, in many cases, MATLAB can perform symbolic integration successfully. For example, create the symbolic variables

```
syms a b theta x y n u z
```

The following table illustrates integration of expressions containing those variables.

f	<code>int(f)</code>
<code>syms x n</code> <code>f = x^n;</code>	<code>int(f)</code> <code>ans =</code> <code>piecewise(n == -1, log(x), n ~= -1, ...</code> <code>x^(n + 1)/(n + 1))</code>

f	int(f)
syms y f = y ⁽⁻¹⁾ ;	int(f) ans = log(y)
syms x n f = n ^x ;	int(f) ans = n ^x /log(n)
syms a b theta f = sin(a*theta+b);	int(f) ans = -cos(b + a*theta)/a
syms u f = 1/(1+u ²);	int(f) ans = atan(u)
syms x f = exp(-x ²);	int(f) ans = (pi ^(1/2) *erf(x))/2

In the last example, $\exp(-x^2)$, there is no formula for the integral involving standard calculus expressions, such as trigonometric and exponential functions. In this case, MATLAB returns an answer in terms of the error function erf .

If MATLAB is unable to find an answer to the integral of a function f , it just returns $\text{int}(f)$.

Definite integration is also possible.

Definite Integral	Command
$\int_a^b f(x)dx$	int(f, a, b)
$\int_a^b f(v)dv$	int(f, v, a, b)

Here are some additional examples.

f	a, b	int(f, a, b)
syms x f = x ⁷ ;	a = 0; b = 1;	int(f, a, b) ans = 1/8
syms x f = 1/x;	a = 1; b = 2;	int(f, a, b) ans = log(2)
syms x f = log(x)*sqrt(x);	a = 0; b = 1;	int(f, a, b) ans = -4/9

f	a, b	int(f, a, b)
<pre>syms x f = exp(-x^2);</pre>	<pre>a = 0; b = inf;</pre>	<pre>int(f, a, b) ans = pi^(1/2)/2</pre>
<pre>syms z f = besselj(1,z)^2;</pre>	<pre>a = 0; b = 1;</pre>	<pre>int(f, a, b) ans = hypergeom([3/2, 3/2],... [2, 5/2, 3], -1)/12</pre>

For the Bessel function (`besselj`) example, it is possible to compute a numerical approximation to the value of the integral, using the `double` function. The commands

```
syms z
a = int(besselj(1,z)^2,0,1)

return

a =
hypergeom([3/2, 3/2], [2, 5/2, 3], -1)/12
```

and the command

```
a = double(a)
```

returns

```
a =
    0.0717
```

Integration with Real Parameters

One of the subtleties involved in symbolic integration is the “value” of various parameters. For example, if a is any positive real number, the expression

$$e^{-ax^2}$$

is the positive, bell shaped curve that tends to 0 as x tends to $\pm\infty$. You can create an example of this curve, for $a = 1/2$.

```
syms x
a = sym(1/2);
f = exp(-a*x^2);
fplot(f)
```

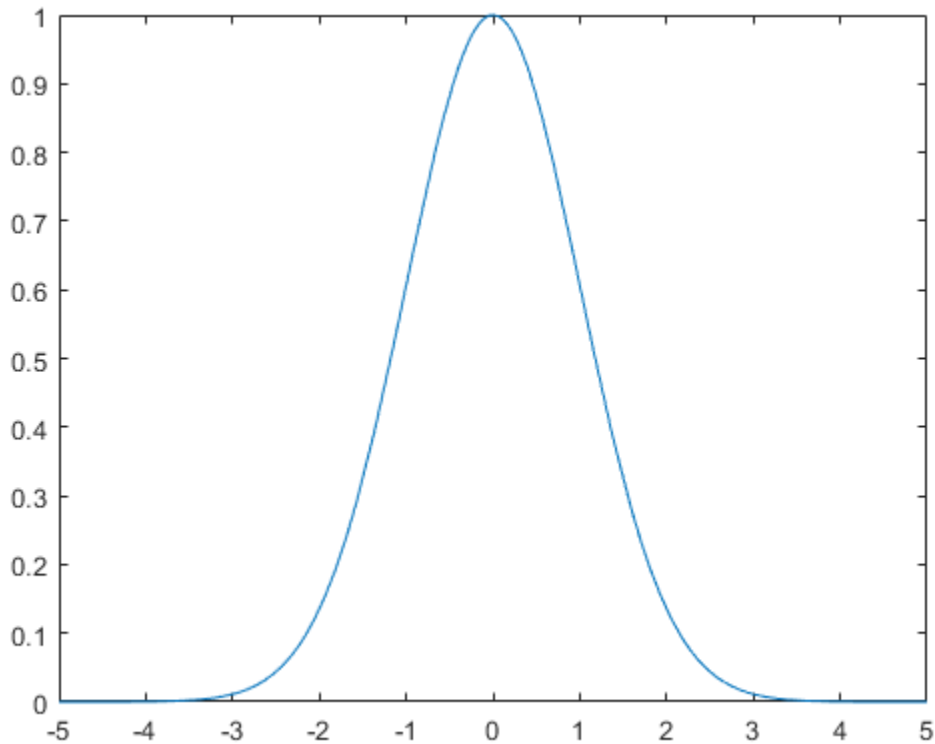

However, if you try to calculate the integral

$$\int_{-\infty}^{\infty} e^{-ax^2} dx$$

without assigning a value to a , MATLAB assumes that a represents a complex number, and therefore returns a piecewise answer that depends on the argument of a . If you are only interested in the case when a is a positive real number, use `assume` to set an assumption on a :

```
syms a
assume(a > 0)
```

Now you can calculate the preceding integral using the commands

```
syms x
f = exp(-a*x^2);
int(f, x, -inf, inf)
```

This returns

```
ans =
pi^(1/2)/a^(1/2)
```

Integration with Complex Parameters

To calculate the integral

$$\int_{-\infty}^{\infty} \frac{1}{a^2 + x^2} dx$$

for complex values of a , enter

```
syms a x
f = 1/(a^2 + x^2);
F = int(f, x, -inf, inf)
```

Use `syms` to clear the all assumptions on variables. For more information about symbolic variables and assumptions on them, see “Delete Symbolic Objects and Their Assumptions” on page 1-25.

The preceding commands produce the complex output

```
F =
(pi*signIm(1i/a))/a
```

The function `signIm` is defined as:

$$\text{signIm}(z) = \begin{cases} 1 & \text{if } \text{Im}(z) > 0, \text{ or } \text{Im}(z) = 0 \text{ and } z < 0 \\ 0 & \text{if } z = 0 \\ -1 & \text{otherwise.} \end{cases}$$

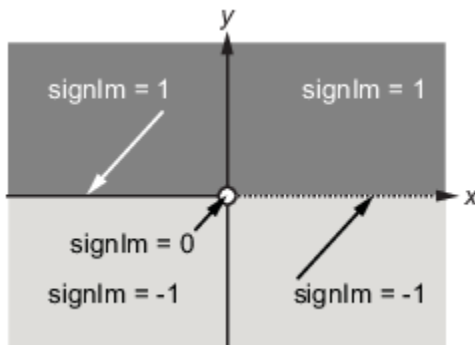

To evaluate F at $a = 1 + i$, enter

```
g = subs(F, 1 + i)
g =
pi*(1/2 - 1i/2)
double(g)
ans =
1.5708 - 1.5708i
```

High-Precision Numerical Integration Using Variable-Precision Arithmetic

High-precision numerical integration is implemented in the `vpaintegral` function of the Symbolic Math Toolbox. `vpaintegral` uses variable-precision arithmetic in contrast to the MATLAB `integral` function, which uses double-precision arithmetic.

Integrate `besseli(5,25*u).*exp(-u*25)` by using both `integral` and `vpaintegral`. The `integral` function returns NaN and issues a warning while `vpaintegral` returns the correct result.

```
syms u
f = besseli(5,25*x).*exp(-x*25);
fun = @(u)besseli(5,25*u).*exp(-u*25);

usingIntegral = integral(fun, 0, 30)
usingVpaintegral = vpaintegral(f, 0, 30)

Warning: Infinite or Not-a-Number value encountered.
usingIntegral =
    NaN

usingVpaintegral =
    0.688424
```

For more information, see `vpaintegral`.

Symbolic Summation

Symbolic Math Toolbox provides two functions for calculating sums:

- `sum` finds the sum of elements of symbolic vectors and matrices. Unlike the MATLAB `sum`, the symbolic `sum` function does not work on multidimensional arrays. For details, follow the MATLAB `sum` page.
- `symsum` finds the sum of a symbolic series.

In this section...

“Comparing `symsum` and `sum`” on page 2-65

“Computational Speed of `symsum` versus `sum`” on page 2-65

“Output Format Differences Between `symsum` and `sum`” on page 2-66

Comparing `symsum` and `sum`

You can find definite sums by using both `sum` and `symsum`. The `sum` function sums the input over a dimension, while the `symsum` function sums the input over an index.

Consider the definite sum $S = \sum_{k=1}^{10} \frac{1}{k^2}$. First, find the terms of the definite sum by substituting the index values for k in the expression. Then, sum the resulting vector using `sum`.

```
syms k
f = 1/k^2;
V = subs(f, k, 1:10)
S_sum = sum(V)

V =
[ 1, 1/4, 1/9, 1/16, 1/25, 1/36, 1/49, 1/64, 1/81, 1/100]
S_sum =
1968329/1270080
```

Find the same sum by using `symsum` by specifying the index and the summation limits. `sum` and `symsum` return identical results.

```
S_symsum = symsum(f, k, 1, 10)

S_symsum =
1968329/1270080
```

Computational Speed of `symsum` versus `sum`

For summing definite series, `symsum` can be faster than `sum`. For summing an indefinite series, you can only use `symsum`.

You can demonstrate that `symsum` can be faster than `sum` by summing a large definite series such as

$$S = \sum_{k=1}^{100000} k^2.$$

To compare runtimes on your computer, use the following commands.

```
syms k
tic
sum(sym(1:100000).^2);
toc
tic
symsum(k^2, k, 1, 100000);
toc
```

Output Format Differences Between `symsum` and `sum`

`symsum` can provide a more elegant representation of sums than `sum` provides. Demonstrate this difference by comparing the function outputs for the definite series $S = \sum_{k=1}^{10} x^k$. To simplify the solution, assume $x > 1$.

```
syms x
assume(x > 1)
S_sum = sum(x.^(1:10))
S_symsum = symsum(x^k, k, 1, 10)

S_sum =
x^10 + x^9 + x^8 + x^7 + x^6 + x^5 + x^4 + x^3 + x^2 + x
S_symsum =
x^11/(x - 1) - x/(x - 1)
```

Show that the outputs are equal by using `isAlways`. The `isAlways` function returns logical 1 (`true`), meaning that the outputs are equal.

```
isAlways(S_sum == S_symsum)

ans =
    logical
     1
```

For further computations, clear the assumptions.

```
assume(x, 'clear')
```

Taylor Series

The statements

```
syms x
f = 1/(5 + 4*cos(x));
T = taylor(f, 'Order', 8)
```

return

```
T =
(49*x^6)/131220 + (5*x^4)/1458 + (2*x^2)/81 + 1/9
```

which is all the terms up to, but not including, order eight in the Taylor series for $f(x)$:

$$\sum_{n=0}^{\infty} (x-a)^n \frac{f^{(n)}(a)}{n!}.$$

Technically, T is a Maclaurin series, since its expansion point is $a = 0$.

These commands

```
syms x
g = exp(x*sin(x));
t = taylor(g, 'ExpansionPoint', 2, 'Order', 12);
```

generate the first 12 nonzero terms of the Taylor series for g about $x = 2$.

t is a large expression; enter

```
size(char(t))
```

```
ans =
      1      99791
```

to find that t has about 100,000 characters in its printed form. In order to proceed with using t , first simplify its presentation:

```
t = simplify(t);
size(char(t))
```

```
ans =
      1      6988
```

Next, plot these functions together to see how well this Taylor approximation compares to the actual function g :

```
xd = 1:0.05:3;
yd = subs(g,x,xd);
fplot(t, [1, 3])
hold on
plot(xd, yd, 'r-.')
title('Taylor approximation vs. actual function')
legend('Taylor', 'Function')
```

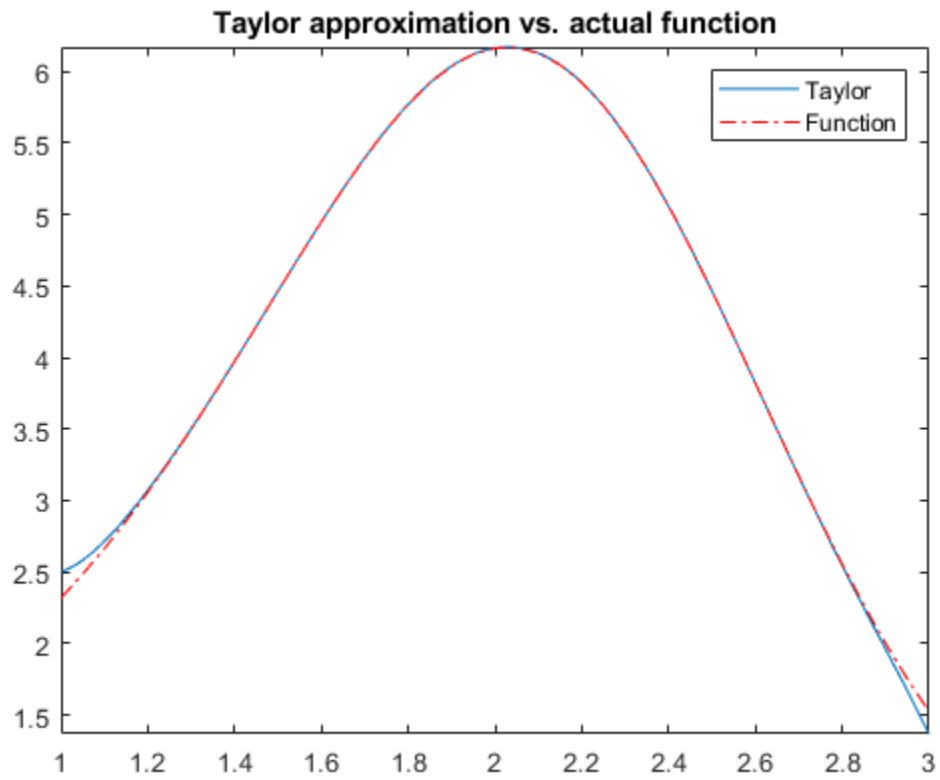

Special thanks is given to Professor Gunnar Bäckström of UMEA in Sweden for this example.

Padé Approximant

The Padé approximant of order $[m, n]$ approximates the function $f(x)$ around $x = x_0$ as

$$\frac{a_0 + a_1(x - x_0) + \dots + a_m(x - x_0)^m}{1 + b_1(x - x_0) + \dots + b_n(x - x_0)^n}.$$

The Padé approximant is a rational function formed by a ratio of two power series. Because it is a rational function, it is more accurate than the Taylor series in approximating functions with poles. The Padé approximant is represented by the Symbolic Math Toolbox function `pade`.

When a pole or zero exists at the expansion point $x = x_0$, the accuracy of the Padé approximant decreases. To increase accuracy, an alternative form of the Padé approximant can be used which is

$$\frac{(x - x_0)^p (a_0 + a_1(x - x_0) + \dots + a_m(x - x_0)^m)}{1 + b_1(x - x_0) + \dots + b_n(x - x_0)^n}.$$

The `pade` function returns the alternative form of the Padé approximant when you set the `OrderMode` input argument to `Relative`.

The Padé approximant is used in control system theory to model time delays in the response of the system. Time delays arise in systems such as chemical and transport processes where there is a delay between the input and the system response. When these inputs are modeled, they are called dead-time inputs. This example shows how to use the Symbolic Math Toolbox to model the response of a first-order system to dead-time inputs using Padé approximants.

The behavior of a first-order system is described by this differential equation

$$\tau \frac{dy(t)}{dt} + y(t) = ax(t).$$

Enter the differential equation in MATLAB.

```
syms tau a x(t) y(t) xS(s) yS(s) H(s) tmp
F = tau*diff(y)+y == a*x;
```

Find the Laplace transform of F using `laplace`.

```
F = laplace(F,t,s)
```

```
F = laplace(y(t),t,s) - tau (y(0) - s laplace(y(t),t,s)) = a laplace(x(t),t,s)
```

Assume the response of the system at $t = 0$ is 0 . Use `subs` to substitute for $y(0) = 0$.

```
F = subs(F,y(0),0)
```

```
F = laplace(y(t),t,s) + s tau laplace(y(t),t,s) = a laplace(x(t),t,s)
```

To collect common terms, use `simplify`.

```
F = simplify(F)
```

```
F = (s tau + 1) laplace(y(t),t,s) = a laplace(x(t),t,s)
```

For readability, replace the Laplace transforms of $x(t)$ and $y(t)$ with $xS(s)$ and $yS(s)$.

```
F = subs(F,[laplace(x(t),t,s) laplace(y(t),t,s)],[xS(s) yS(s)])
```

```
F = yS(s)(s*tau + 1) = a*xS(s)
```

The Laplace transform of the transfer function is $yS(s)/xS(s)$. Divide both sides of the equation by $xS(s)$ and use `subs` to replace $yS(s)/xS(s)$ with $H(s)$.

```
F = F/xS(s);
```

```
F = subs(F,yS(s)/xS(s),H(s))
```

```
F = H(s)(s*tau + 1) = a
```

Solve the equation for $H(s)$. Substitute for $H(s)$ with a dummy variable, solve for the dummy variable using `solve`, and assign the solution back to $H(s)$.

```
F = subs(F,H(s),tmp);
```

```
H(s) = solve(F,tmp)
```

```
H(s) =
```

$$\frac{a}{s\tau + 1}$$

The input to the first-order system is a time-delayed step input. To represent a step input, use `heaviside`. Delay the input by three time units. Find the Laplace transform using `laplace`.

```
step = heaviside(t - 3);
```

```
step = laplace(step)
```

```
step =
```

$$\frac{e^{-3s}}{s}$$

Find the response of the system, which is the product of the transfer function and the input.

```
y = H(s)*step
```

```
y =
```

$$\frac{a e^{-3s}}{s(s\tau + 1)}$$

To allow plotting of the response, set parameters `a` and `tau` to their values. For `a` and `tau`, choose values 1 and 3, respectively.

```
y = subs(y,[a tau],[1 3]);
```

```
y = ilaplace(y,s);
```

Find the Padé approximant of order [2 2] of the step input using the `Order` input argument to `pade`.

```
stepPade22 = pade(step,'Order',[2 2])
```

```
stepPade22 =
```

$$\frac{3s^2 - 4s + 2}{2s(s + 1)}$$

Find the response to the input by multiplying the transfer function and the Padé approximant of the input.

```
yPade22 = H(s)*stepPade22
```

$$y_{\text{Pade22}} = \frac{a(3s^2 - 4s + 2)}{2s(s\tau + 1)(s + 1)}$$

Find the inverse Laplace transform of y_{Pade22} using `ilaplace`.

```
yPade22 = ilaplace(yPade22,s)
```

```
yPade22 =
```

$$a + \frac{9a e^{-s}}{2\tau - 2} - \frac{a e^{-\frac{s}{\tau}} (2\tau^2 + 4\tau + 3)}{\tau(2\tau - 2)}$$

To plot the response, set parameters a and τ to their values of 1 and 3, respectively.

```
yPade22 = subs(yPade22,[a tau],[1 3])
```

```
yPade22 =
```

$$\frac{9 e^{-s}}{4} - \frac{11 e^{-\frac{s}{3}}}{4} + 1$$

Plot the response of the system y and the response calculated from the Padé approximant y_{Pade22} .

```
hold on
grid on
fplot([y yPade22],[0 20])
title('Padé Approximant for dead-time step input')
legend('Response to dead-time step input',...
       'Padé approximant [2 2]',...
       'Location', 'Best')
```

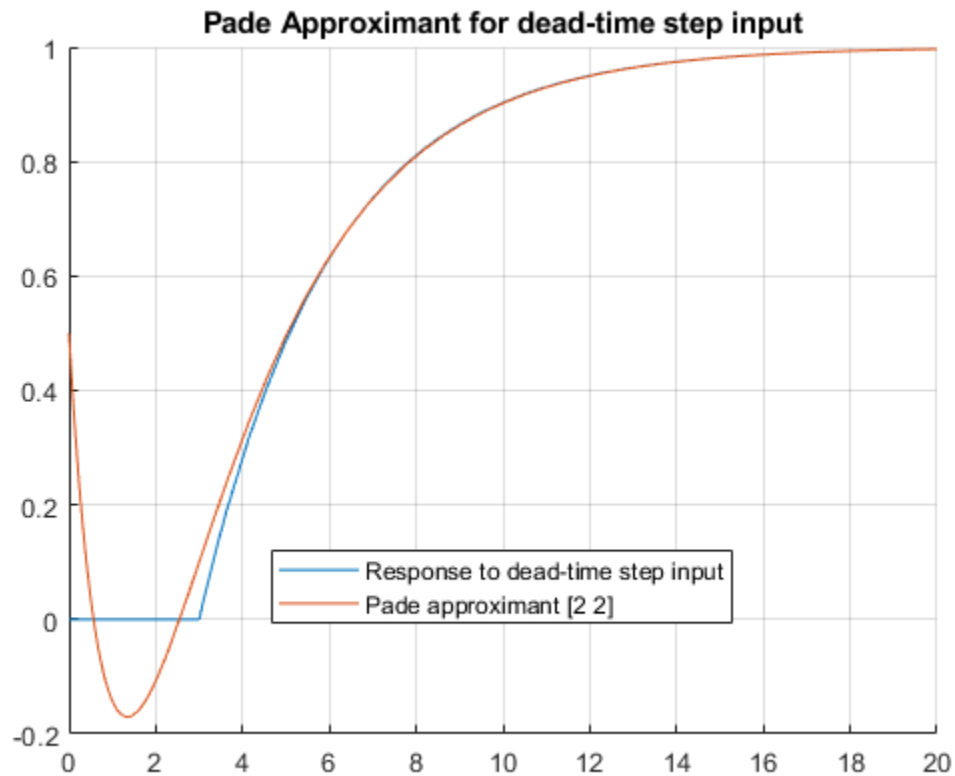

The [2 2] Padé approximant does not represent the response well because a pole exists at the expansion point of 0. To increase the accuracy of pade when there is a pole or zero at the expansion point, set the OrderMode input argument to Relative and repeat the steps. For details, see pade.

```
stepPade22Rel = pade(step, 'Order', [2 2], 'OrderMode', 'Relative')
```

$$\text{stepPade22Rel} = \frac{3s^2 - 6s + 4}{s(3s^2 + 6s + 4)}$$

```
yPade22Rel = H(s)*stepPade22Rel
```

$$y\text{Pade22Rel} = \frac{a(3s^2 - 6s + 4)}{s(s\tau + 1)(3s^2 + 6s + 4)}$$

```
yPade22Rel = ilaplace(yPade22Rel)
```

$$y\text{Pade22Rel} = a - \frac{a e^{-\frac{t}{\tau}} (4\tau^2 + 6\tau + 3)}{\sigma_1} + \frac{12 a \tau e^{-t} \left(\cos\left(\frac{\sqrt{3}t}{3}\right) - \sqrt{3} \sin\left(\frac{\sqrt{3}t}{3}\right) \left(\frac{36a - 72a\tau}{36a\tau} + 1 \right) \right)}{\sigma_1}$$

where

$$\sigma_1 = 4\tau^2 - 6\tau + 3$$

```
yPade22Rel = subs(yPade22Rel,[a tau],[1 3])
```

```
yPade22Rel =
```

$$\frac{12 e^{-t} \left(\cos\left(\frac{\sqrt{3}t}{3}\right) + \frac{2\sqrt{3} \sin\left(\frac{\sqrt{3}t}{3}\right)}{3} \right)}{7} - \frac{19 e^{-\frac{t}{3}}}{7} + 1$$

```
fplot(yPade22Rel,[0 20], 'DisplayName', 'Relative Pade approximant [2 2]')
```

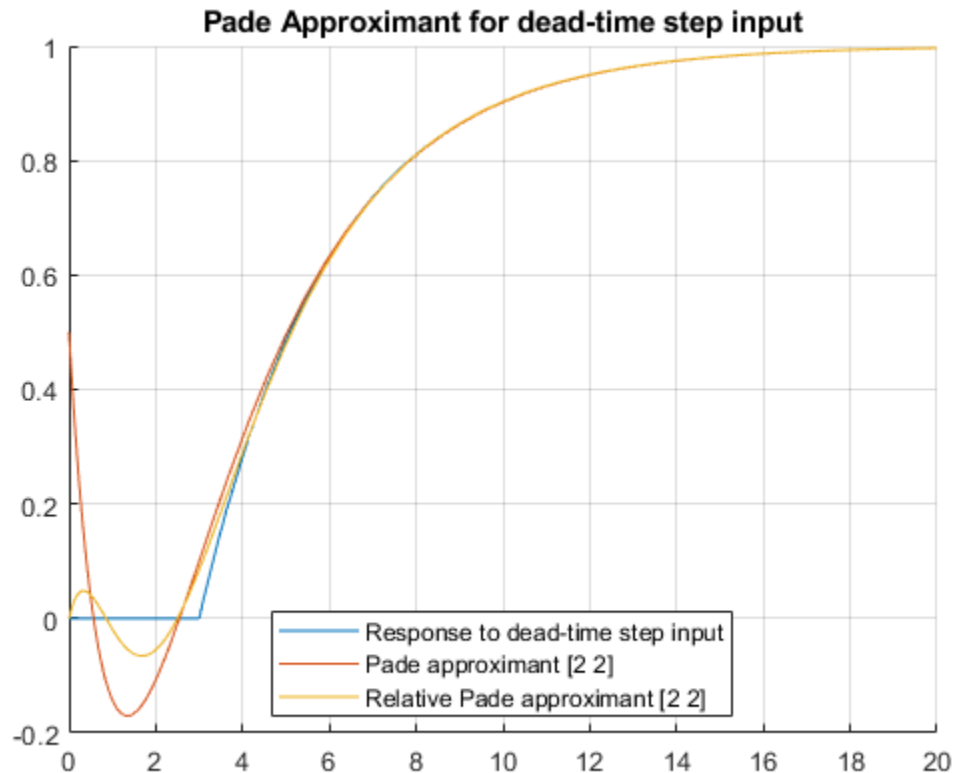

The accuracy of the Padé approximant can also be increased by increasing its order. Increase the order to [4 5] and repeat the steps. The [n-1 n] Padé approximant is better at approximating the response at $t = 0$ than the [n n] Padé approximant.

```
stepPade45 = pade(step, 'Order', [4 5])
```

```
stepPade45 =
```

$$\frac{27 s^4 - 180 s^3 + 540 s^2 - 840 s + 560}{s(27 s^4 + 180 s^3 + 540 s^2 + 840 s + 560)}$$

```
yPade45 = H(s)*stepPade45
```

```
yPade45 =
```

$$\frac{a(27 s^4 - 180 s^3 + 540 s^2 - 840 s + 560)}{s(s\tau + 1)(27 s^4 + 180 s^3 + 540 s^2 + 840 s + 560)}$$

```
yPade45 = subs(yPade45,[a tau],[1 3])
```

$$yPade45 = \frac{27s^4 - 180s^3 + 540s^2 - 840s + 560}{s(3s+1)(27s^4 + 180s^3 + 540s^2 + 840s + 560)}$$

`yPade45 = ilaplace(yPade45)`

$$yPade45 = \frac{294120 \left(\sum_{k=1}^4 \frac{e^{t\sigma_2} \sigma_2^2}{\sigma_1} \right)}{1001} - \frac{2721 e^{-\frac{t}{3}}}{1001} + \frac{46440 \left(\sum_{k=1}^4 \frac{e^{t\sigma_2} \sigma_2^3}{\sigma_1} \right)}{1001} + \frac{172560 \left(\sum_{k=1}^4 \frac{e^{t\sigma_2}}{\sigma_1} \right)}{143} + \frac{101520 \left(\sum_{k=1}^4 \frac{e^{\sigma_2 t}}{12(90\sigma_2 + 45)} \right)}{143}$$

where

$$\sigma_1 = 12(9\sigma_2^3 + 45\sigma_2^2 + 90\sigma_2 + 70)$$

$$\sigma_2 = \text{root}\left(s_5^4 + \frac{20s_5^3}{3} + 20s_5^2 + \frac{280s_5}{9} + \frac{560}{27}, s_5, k\right)$$

`yPade45 = vpa(yPade45)`

$$yPade45 = 3.2418384981662546679005910164486 e^{-1.930807068546914778929595950184 t} \cos(0.57815608595633583454598214328008 t) - 2.7182817182817182817182817182817 e^{-0.33333333333333333333333333333333 t} - 1.5235567798845363861823092981669 e^{-1.4025262647864185544037373831494 t} \cos(1.7716120279045018112388813990878 t) + 11.595342871672681856604670597166 e^{-1.930807068546914778929595950184 t} \sin(0.57815608595633583454598214328008 t) - 1.7803798379230333426855987436911 e^{-1.4025262647864185544037373831494 t} \sin(1.7716120279045018112388813990878 t) + 1.0$$

`fplot(yPade45,[0 20], 'DisplayName', 'Pade approximant [4 5]')`

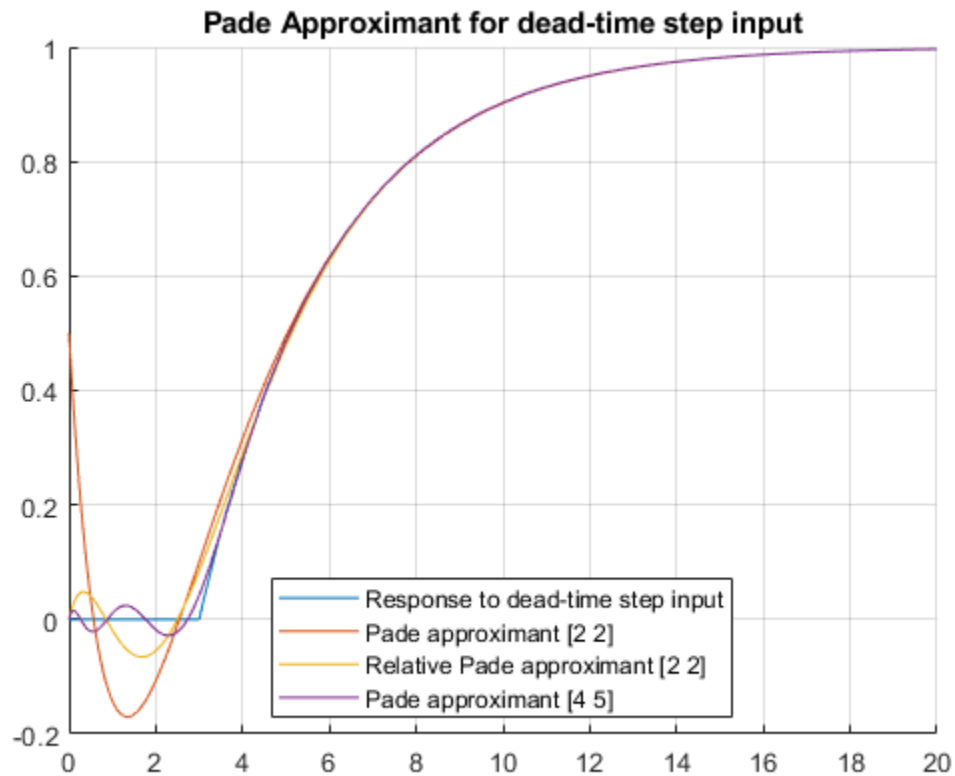

The following points have been shown:

- Padé approximants can model dead-time step inputs.
- The accuracy of the Padé approximant increases with the increase in the order of the approximant.
- When a pole or zero exists at the expansion point, the Padé approximant is inaccurate about the expansion point. To increase the accuracy of the approximant, set the `OrderMode` option to `Relative`. You can also use increase the order of the denominator relative to the numerator.

Find Asymptotes, Critical, and Inflection Points

This example describes how to analyze a simple function to find its asymptotes, maximum, minimum, and inflection point.

Define a Function

The function in this example is

$$f(x) = \frac{3x^2 + 6x - 1}{x^2 + x - 3}.$$

First, create the function.

```
syms x
num = 3*x^2 + 6*x - 1;
denom = x^2 + x - 3;
f = num/denom
```

f =

$$\frac{3x^2 + 6x - 1}{x^2 + x - 3}$$

Plot the function by using `fplot`. The `fplot` function automatically shows horizontal and vertical asymptotes.

```
fplot(f)
```

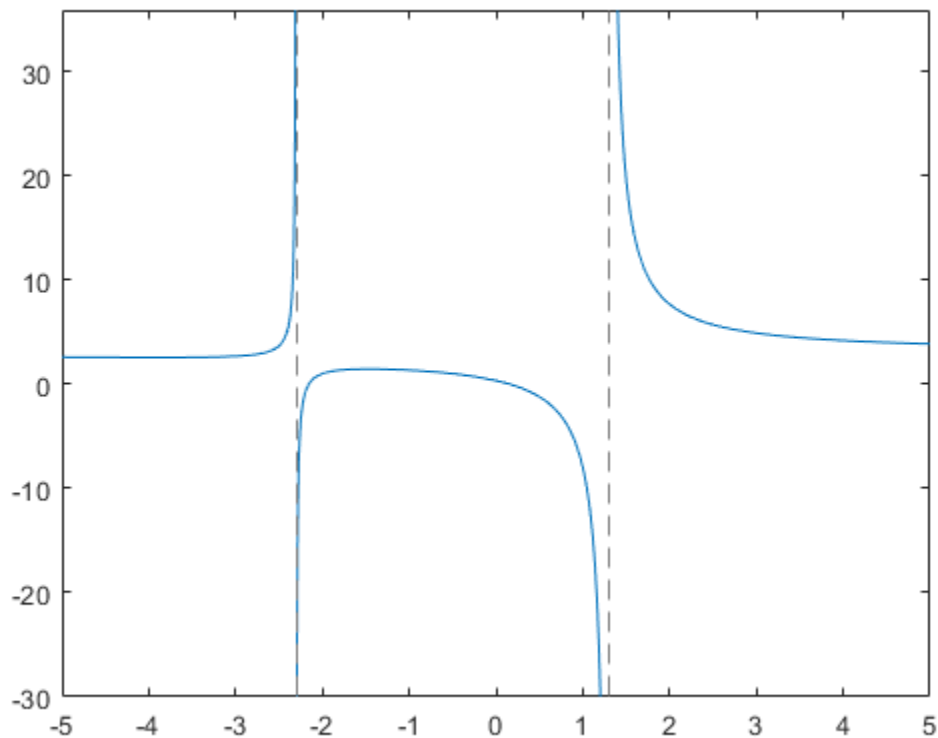

Find Asymptotes

To find the horizontal asymptote of f mathematically, take the limit of f as x approaches positive infinity.

```
limit(f,Inf)
```

```
ans = 3
```

The limit as x approaches negative infinity is also 3. This result means the line $y = 3$ is a horizontal asymptote to f .

To find the vertical asymptotes of f , set the denominator equal to 0 and solve it.

```
roots = solve(denom)
```

```
roots =
```

$$\begin{pmatrix} -\frac{\sqrt{13}}{2} - \frac{1}{2} \\ \frac{\sqrt{13}}{2} - \frac{1}{2} \end{pmatrix}$$

`roots` indicates that the vertical asymptotes are the lines

$$x = \frac{-1 - \sqrt{13}}{2}$$

and

$$x = \frac{-1 + \sqrt{13}}{2}.$$

Find Maximum and Minimum

You can see from the graph that f has a local maximum between the points $x = -2$ and $x = 0$. It also has a local minimum between $x = -6$ and $x = -2$. To find the x -coordinates of the maximum and minimum, first take the derivative of f .

```
f1 = diff(f)
```

```
f1 =
```

$$\frac{6x+6}{x^2+x-3} - \frac{(2x+1)(3x^2+6x-1)}{(x^2+x-3)^2}$$

To simplify this expression, enter the following.

```
f1 = simplify(f1)
```

```
f1 =
```

$$-\frac{3x^2+16x+17}{(x^2+x-3)^2}$$

Next, set the derivative equal to 0 and solve for the critical points.

```
crit_pts = solve(f1)
```

```
crit_pts =
```

$$\begin{pmatrix} -\frac{\sqrt{13}}{3} - \frac{8}{3} \\ \frac{\sqrt{13}}{3} - \frac{8}{3} \end{pmatrix}$$

As the graph of f shows, the function has a local minimum at

$$x_1 = \frac{-8 - \sqrt{13}}{3}$$

and a local maximum at

$$x_1 = \frac{-8 + \sqrt{13}}{3}.$$

Plot the maximum and minimum of f .

```
fplot(f)
hold on
plot(double(crit_pts), double(subs(f,crit_pts)), 'ro')
title('Maximum and Minimum of f')
text(-4.8, 5.5, 'Local minimum')
text(-2, 4, 'Local maximum')
hold off
```

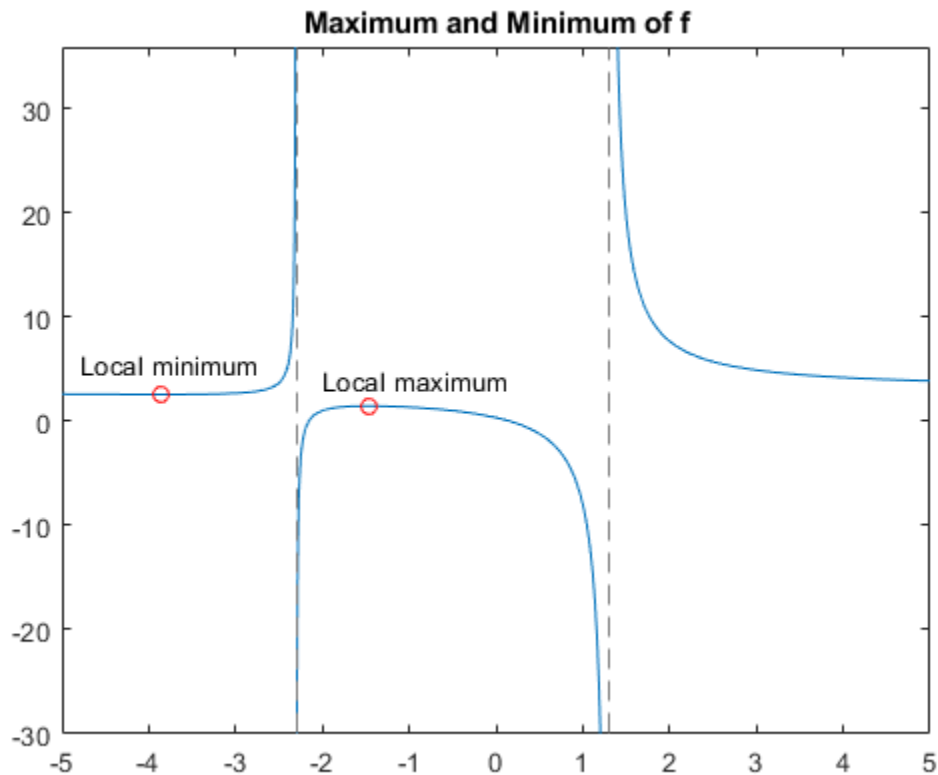

Find Inflection Point

To find the inflection point of f , set the second derivative equal to 0 and solve for this condition.

```
f2 = diff(f1);
inflec_pt = solve(f2, 'MaxDegree', 3);
double(inflec_pt)

ans = 3×1 complex

-5.2635 + 0.0000i
-1.3682 - 0.8511i
-1.3682 + 0.8511i
```

In this example, only the first element is a real number, so this is the only inflection point. MATLAB® does not always return the roots to an equation in the same order.

Instead of selecting the real root by indexing into `inter_pt`, identify the real root by determining which roots have a zero-valued imaginary part.

```
idx = imag(double(inflec_pt)) == 0;
inflec_pt = inflec_pt(idx)
```

```
inflec_pt =
```

$$-\frac{13}{9\left(\frac{169}{54} - \frac{\sqrt{2197}}{18}\right)^{1/3}} - \left(\frac{169}{54} - \frac{\sqrt{2197}}{18}\right)^{1/3} - \frac{8}{3}$$

Plot the inflection point. The extra argument `[-9 6]` in `fplot` extends the range of `x` values in the plot so that you can see the inflection point more clearly, as the figure shows.

```
fplot(f, [-9 6])
hold on
plot(double(inflec_pt), double(subs(f, inflec_pt)), 'ro')
title('Inflection Point of f')
text(-7, 1, 'Inflection point')
hold off
```

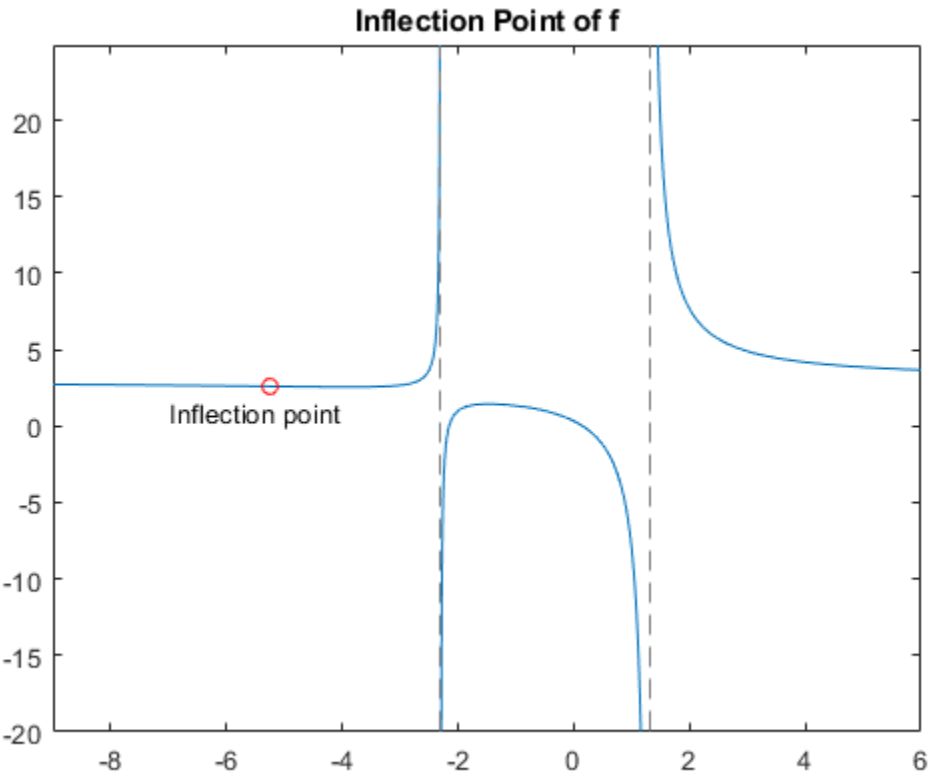

Simplify Symbolic Expressions

Simplification of a mathematical expression is not a clearly defined subject. There is no universal idea as to which form of an expression is simplest. The form of a mathematical expression that is simplest for one problem turns out to be complicated or even unsuitable for another problem. For example, the following two mathematical expressions present the same polynomial in different forms:

$$(x + 1)(x - 2)(x + 3)(x - 4),$$

$$x^4 - 2x^3 - 13x^2 + 14x + 24.$$

The first form clearly shows the roots of this polynomial. This form is simpler for working with the roots. The second form serves best when you want to see the coefficients of the polynomial. For example, this form is convenient when you differentiate or integrate polynomials.

If the problem you want to solve requires a particular form of an expression, the best approach is to choose the appropriate simplification function. See “Choose Function to Rearrange Expression” on page 2-104.

Besides specific simplifiers, Symbolic Math Toolbox offers a general simplifier, `simplify`.

If you do not need a particular form of expressions (expanded, factored, or expressed in particular terms), use `simplify` to shorten mathematical expressions. For example, use this simplifier to find a shorter form for a final result of your computations.

`simplify` works on various types of symbolic expressions, such as polynomials, expressions with trigonometric, logarithmic, and special functions. For example, simplify these polynomials.

```
syms x y
simplify((1 - x^2)/(1 - x))
simplify((x - 1)*(x + 1)*(x^2 + x + 1)*(x^2 + 1)*(x^2 - x + 1)*(x^4 - x^2 + 1))

ans =
x + 1

ans =
x^12 - 1
```

Simplify expressions involving trigonometric functions.

```
simplify(cos(x)^(-2) - tan(x)^2)
simplify(cos(x)^2 - sin(x)^2)

ans =
1

ans =
cos(2*x)
```

Simplify expressions involving exponents and logarithms. In the third expression, use `log(sym(3))` instead of `log(3)`. If you use `log(3)`, then MATLAB calculates `log(3)` with the double precision, and then converts the result to a symbolic number.

```
simplify(exp(x)*exp(y))
simplify(exp(x) - exp(x/2)^2)
simplify(log(x) + log(sym(3)) - log(3*x) + (exp(x) - 1)/(exp(x/2) + 1))
```

```
ans =  
exp(x + y)
```

```
ans =  
0
```

```
ans =  
exp(x/2) - 1
```

Simplify expressions involving special functions.

```
simplify(gamma(x + 1) - x*gamma(x))  
simplify(besselj(2, x) + besselj(0, x))
```

```
ans =  
0
```

```
ans =  
(2*besselj(1, x))/x
```

You also can simplify symbolic functions by using `simplify`.

```
syms f(x,y)  
f(x,y) = exp(x)*exp(y)  
f = simplify(f)
```

```
f(x, y) =  
exp(x)*exp(y)
```

```
f(x, y) =  
exp(x + y)
```

Simplify Using Options

By default, `simplify` uses strict simplification rules and ensures that simplified expressions are always mathematically equivalent to initial expressions. For example, it does not combine logarithms for complex values in general.

```
syms x  
simplify(log(x^2) + log(x))
```

```
ans =  
log(x^2) + log(x)
```

You can apply additional simplification rules which are not correct for all values of parameters and all cases, but using which `simplify` can return shorter results. For this approach, use `IgnoreAnalyticConstraints`. For example, simplifying the same expression with `IgnoreAnalyticConstraints`, you get the result with combined logarithms.

```
simplify(log(x^2) + log(x), 'IgnoreAnalyticConstraints', true)
```

```
ans =  
3*log(x)
```

`IgnoreAnalyticConstraints` provides a shortcut allowing you to simplify expressions under commonly used assumptions about values of the variables. Alternatively, you can set appropriate assumptions on variables explicitly. For example, combining logarithms is not valid for complex values

in general. If you assume that x is a real value, `simplify` combines logarithms without `IgnoreAnalyticConstraints`.

```
assume(x,'real')
simplify(log(x^2) + log(x))
```

```
ans =
log(x^3)
```

For further computations, clear the assumption on x by recreating it using `syms`.

```
syms x
```

Another approach that can improve simplification of an expression or function is the syntax `simplify(f, 'Steps', n)`, where n is a positive integer that controls how many steps `simplify` takes. Specifying more simplification steps can help you simplify the expression better, but it takes more time. By default, $n = 1$. For example, create and simplify this expression. The result is shorter than the original expression, but it can be simplified further.

```
syms x
y = (cos(x)^2 - sin(x)^2)*sin(2*x)*(exp(2*x) - 2*exp(x) + 1)/...
    ((cos(2*x)^2 - sin(2*x)^2)*(exp(2*x) - 1));
simplify(y)
```

```
ans =
(sin(4*x)*(exp(x) - 1))/(2*cos(4*x)*(exp(x) + 1))
```

Specify the number of simplification steps for the same expression. First, use 25 steps.

```
simplify(y,'Steps',25)
```

```
ans =
(tan(4*x)*(exp(x) - 1))/(2*(exp(x) + 1))
```

Use 50 steps to simplify the expression even further.

```
simplify(y,'Steps',50)
```

```
ans =
(tan(4*x)*tanh(x/2))/2
```

Suppose, you already simplified an expression or function, but you want the other forms of the same expression. To do this, you can set the `'All'` option to `true`. The syntax `simplify(f, 'Steps', n, 'All', true)` shows other equivalent results of the same expression in the simplification steps.

```
syms x
y = cos(x) + sin(x)
simplify(y,'Steps',10,'All',true)
```

```
ans =
                2^(1/2)*sin(x + pi/4)
                2^(1/2)*cos(x - pi/4)
                cos(x) + sin(x)
2^(1/2)*((exp(- x*1i - (pi*1i)/4)*1i)/2 - (exp(x*1i + (pi*1i)/4)*1i)/2)
```

To return even more equivalent results, increase the number of steps to 25.

```
simplify(y,'Steps',25,'All',true)
```

```
ans =
                2^(1/2)*sin(x + pi/4)
                2^(1/2)*cos(x - pi/4)
                cos(x) + sin(x)
                -2^(1/2)*(2*sin(x/2 - pi/8)^2 - 1)
2^(1/2)*(exp(- x*1i + (pi*1i)/4)/2 + exp(x*1i - (pi*1i)/4)/2)
2^(1/2)*((exp(- x*1i - (pi*1i)/4)*1i)/2 - (exp(x*1i + (pi*1i)/4)*1i)/2)
```

Simplify Using Assumptions

Some expressions cannot be simplified in general, but become much shorter under particular assumptions. For example, simplifying this trigonometric expression without additional assumptions returns the original expression.

```
syms n
simplify(sin(2*n*pi))
```

```
ans =
sin(2*pi*n)
```

However, if you assume that variable n represents an integer, the same trigonometric expression simplifies to 0.

```
assume(n, 'integer')
simplify(sin(2*n*pi))
```

```
ans =
0
```

For further computations, clear the assumption.

```
syms n
```

Simplify Fractions

You can use the general simplification function, `simplify`, to simplify fractions. However, Symbolic Math Toolbox offers a more efficient function specifically for this task: `simplifyFraction`. The statement `simplifyFraction(f)` represents the expression f as a fraction, where both the numerator and denominator are polynomials whose greatest common divisor is 1. For example, simplify these expressions.

```
syms x y
simplifyFraction((x^3 - 1)/(x - 1))
```

```
ans =
x^2 + x + 1
```

```
simplifyFraction((x^3 - x^2*y - x*y^2 + y^3)/(x^3 + y^3))
```

```
ans =
(x^2 - 2*x*y + y^2)/(x^2 - x*y + y^2)
```

By default, `simplifyFraction` does not expand expressions in the numerator and denominator of the returned result. To expand the numerator and denominator in the resulting expression, use the `Expand` option. For comparison, first simplify this fraction without `Expand`.

```
simplifyFraction((1 - exp(x)^4)/(1 + exp(x))^4)
```



```
ans =  
(exp(2*x) - exp(3*x) - exp(x) + 1)/(exp(x) + 1)^3
```

Now, simplify the same expressions with Expand.

```
simplifyFraction((1 - exp(x)^4)/(1 + exp(x))^4, 'Expand', true)
```

```
ans =  
(exp(2*x) - exp(3*x) - exp(x) + 1)/(3*exp(2*x) + exp(3*x) + 3*exp(x) + 1)
```

Solve Algebraic Equation Using Live Editor Task

You can interactively solve algebraic equations to obtain symbolic solutions using the Solve Symbolic Equation task in the Live Editor. For more information on Live Editor tasks, see “Add Interactive Tasks to a Live Script” (MATLAB).

These examples show you how to find the solutions of

- a trigonometric equation
- a cubic equation
- a system of cubic and linear equations

Solve a Trigonometric Equation

Find the solution of the trigonometric equation $\sin(x) + \cos(x) = 0$ with the assumption that $x > \pi/2$.

First, go to the **Home** tab, and create a live script by clicking  **New Live Script**. Define the symbolic variable x , and use the `==` operator to declare the equality sign of the trigonometric equation. Use `assume` to set the assumption on x .

```
syms x
eqn = sin(x) + cos(x) == 0;
assume(x > pi/2);
```

In the **Live Editor** tab, run the code by clicking  **Run** to store x with its assumption and `eqn` into the current workspace.

Next, open the **Solve Symbolic Equation** task by selecting **Task > Solve Symbolic Equation** in the **Live Editor** tab. To find the solution of the trigonometric equation, select the symbolic equation `eqn` from the workspace. Specify x as the variable to solve for. Select the **Return conditions** option to return the general solution and the analytic constraints under which it holds.

Solve Symbolic Equation ● ⋮

`solution` = Analytic solution of equation `eqn` with respect to `x` with conditions

Select equation

Equation eqn Variables x *for example: x*

Specify solver options

Return real solutions
 Return conditions
 Ignore analytic constraints
 Return one solution
 Expand all roots
 Ignore properties

Display result

Equation
 Solution

`solution` = *struct with fields:*

```

x: [1x1 sym]
parameters: [1x1 sym]
conditions: [1x1 sym]

```

where

$$x = \pi k - \frac{\pi}{4} \text{ for all } k \text{ with } 1 \leq k \wedge k \in \mathbb{Z}$$

You can ignore the assumption on `x` by selecting the **Ignore properties** option. Return the solution without using the assumption that $x > \pi/2$.

Specify solver options

Return real solutions
 Return conditions
 Ignore analytic constraints
 Return one solution
 Expand all roots
 Ignore properties

Display result

Equation
 Solution

▼

```

solution = struct with fields:
    x: [1x1 sym]
    parameters: [1x1 sym]
    conditions: [1x1 sym]
where

$$x = \pi k - \frac{\pi}{4} \text{ for all } k \text{ with } k \in \mathbb{Z}$$

```

To experiment with solving symbolic equations, you can repeat the previous steps for other system equations and solver options. You can run the following examples by adding the code to the existing live script or a new live script.

Solve a Cubic Equation

Find the solutions of the cubic equation $x^3 - 2x^2 + y = 0$.

Define the symbolic variables x and y using `syms`, and use the `==` operator to declare the equality sign of the cubic equation.

```

syms x y
cubicEquation = x^3 - 2*x^2 + y == 0;

```

To find the solutions of the cubic equation, select the symbolic equation `cubicEquation` from the workspace. Specify x as the variable to solve for.

Solve Symbolic Equation ● ⋮

`solution` = Analytic solution of equation **cubicEquation** with respect to `x`

Select equation

Equation cubicEquation ▼ Variables x ▼ *for example: x,y*

Specify solver options

Return real solutions
 Return conditions
 Ignore analytic constraints
 Return one solution
 Expand all roots
 Ignore properties

Display result

Equation
 Solution

▼

`solution` =

$$\begin{pmatrix} \text{root}(z^3 - 2z^2 + y, z, 1) \\ \text{root}(z^3 - 2z^2 + y, z, 2) \\ \text{root}(z^3 - 2z^2 + y, z, 3) \end{pmatrix}$$

The solver returns the symbolic solutions in terms of the root function. To express the root function in terms of square roots, select the **Expand all roots** option.

Specify solver options

Return real solutions
 Return conditions
 Ignore analytic constraints
 Return one solution
 Expand all roots
 Ignore properties

Display result

Equation
 Solution

▼

solution =

$$\begin{pmatrix} \frac{4}{9\sigma_2} + \sigma_2 + \frac{2}{3} \\ \frac{2}{3} - \frac{\sigma_2}{2} - \frac{2}{9\sigma_2} - \sigma_1 \\ \frac{2}{3} - \frac{\sigma_2}{2} - \frac{2}{9\sigma_2} + \sigma_1 \end{pmatrix}$$

where

$$\sigma_1 = \frac{\sqrt{3} \left(\frac{4}{9\sigma_2} - \sigma_2 \right) i}{2}$$

$$\sigma_2 = \left(\sqrt{\left(\frac{y-8}{2} - \frac{8}{27} \right)^2 - \frac{64}{729}} - \frac{y}{2} + \frac{8}{27} \right)^{1/3}$$

Solve a System of Equations

Solve the system of cubic and linear equations:

$$\begin{aligned} x^3 - 2x^2 + y &= 0 \\ y &= 4x - 8 \end{aligned}$$

Define the symbolic variables x and y using `syms`. Use the `==` operator to declare the equality sign of the equations. To declare the system of equations, combine the two symbolic equations into an array.

```
syms x y
cubicEquation = x^3 - 2*x^2 + y == 0;
linearEquation = y == 4*x - 8;
systemEquations = [cubicEquation linearEquation];
```

To find the solution of the system of equations, select the symbolic equation `systemEquations` from the workspace. Specify x and y as the variables to solve for.

Solve Symbolic Equation ● ⋮

`solution` = Analytic solution of equation **systemEquations** with respect to x,y

Select equation

Equation systemEquations ▼ Variables x,y ▼ *for example: x,y*

Specify solver options

Return real solutions
 Return conditions
 Ignore analytic constraints
 Return one solution
 Expand all roots
 Ignore properties

Display result

Equation
 Solution

▼

```

solution = struct with fields:
  x: [3x1 sym]
  y: [3x1 sym]
where
[x(1), y(1)] = (2 0)
[x(2), y(2)] = (-2i -8 - 8i)
[x(3), y(3)] = (2i -8 + 8i)

```

The solver returns real and complex solutions. To show real solutions only, select the **Return real solutions** option.

Specify solver options

Return real solutions
 Return conditions
 Ignore analytic constraints
 Return one solution
 Expand all roots
 Ignore properties

Display result

Equation
 Solution

▼

```

solution = struct with fields:
  x: [1x1 sym]
  y: [1x1 sym]
where
[x, y] = (2 0)
  
```

Generate Code

To view the code that a task used, click ▼ at the bottom of the task window. The task displays the code block, which you can cut and paste to use or modify later in the existing script or a different program. For example:

Display result

Equation
 Solution

▲

```

% Compute analytic solution of a symbolic equation
solution = solve(systemEquations,[x,y],'Real',true);
% Display symbolic solution returned by solve
displaySymSolution(solution);

solution = struct with fields:
  x: [1x1 sym]
  y: [1x1 sym]
where
[x, y] = (2 0)
  
```

Because the underlying code is now part of your live script, you can continue to use the solutions generated by the task for further processing. For example, you can plot the system of equations and their real-valued solution.

```
fplot(-x^3 + 2*x^2)
xlabel('x')
ylabel('y')
hold on
fplot(4*x - 8)
plot(solution.x,solution.y,'bo')
```

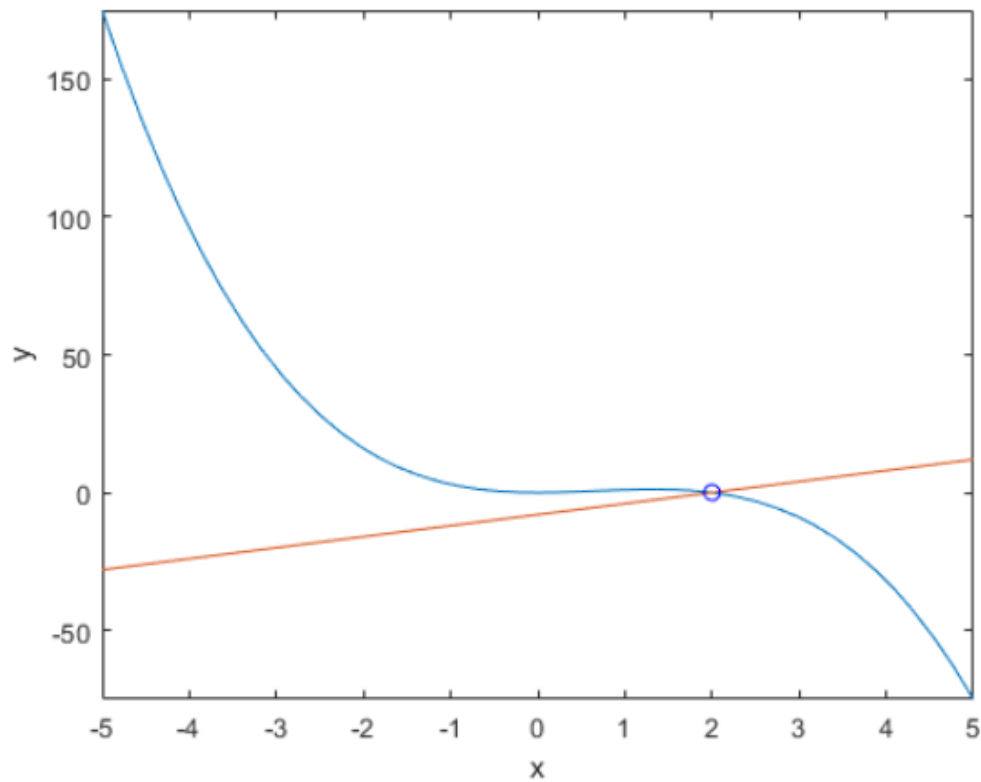

See Also

Live Editor Tasks

[Simplify Symbolic Expression](#) | [Solve Symbolic Equation](#)

Functions

`solve`

Related Examples

- “Add Interactive Tasks to a Live Script” (MATLAB)
- “Solve Algebraic Equation” on page 2-153

Simplify Symbolic Expressions Using Live Editor Task

You can interactively simplify or rearrange symbolic expressions using the Simplify Symbolic Expression task in the Live Editor. For more information on Live Editor tasks, see “Add Interactive Tasks to a Live Script” (MATLAB).

This example shows you how to simplify or rearrange various symbolic expressions into the particular form you require by choosing the appropriate method.

Simplify a Symbolic Expression

Simplify the expression $i \frac{e^{-ix} - e^{ix}}{e^{-ix} + e^{ix}}$.

First, go to the **Home** tab, and create a live script by clicking  **New Live Script**. Define the symbolic variable x and declare the expression as a symbolic expression.

```
syms x;
expr = 1i*(exp(-1i*x) - exp(1i*x))/(exp(-1i*x) + exp(1i*x));
```

In the **Live Editor** tab, run the code by clicking  **Run** to store x and $expr$ into the current workspace.

Next, open the **Simplify Symbolic Expression** task by selecting **Task > Simplify Symbolic Expression** in the **Live Editor** tab. Select the symbolic expression $expr$ from the workspace and specify the simplification method as **Simplify**. Select **Minimum** for the computational effort (fastest computation time).

Simplify Symbolic Expression

simplifiedExpr = Compute simplified symbolic expression

Select expression

Expression **expr**

Specify simplification method

Method **Simplify** Effort **Minimum**

Display result

Expression Simplified expression

simplifiedExpr =

$$-\frac{e^{2xi}i - i}{e^{2xi} + 1}$$

To get a simpler expression, change the computational effort to **Medium**.

Specify simplification method

Method Effort

Display result

Expression Simplified expression

simplifiedExpr = $\tan(x)$

To experiment with simplifying symbolic expressions, you can repeat the previous steps for other symbolic expressions and simplification methods. You can run the following examples by adding the code to the existing live script or a new live script.

Simplify a Polynomial Fraction

Simplify the polynomial fraction $\frac{(x^2 - 1)(x + 1)}{x^2 - 2x + 1}$.

Declare the polynomial fraction as a symbolic expression.

```
expr2 = ((x^2 - 1)*(x + 1))/(x^2 - 2*x + 1);
```

Select the symbolic expression `expr2` from the workspace and specify the simplification method as `Simplify fraction`.

Simplify Symbolic Expression

simplifiedExpr = Compute simplified symbolic expression

Select expression

Expression

Specify simplification method

Method Expand

Display result

Expression Simplified expression

simplifiedExpr =

$$\frac{(x + 1)^2}{x - 1}$$

Select the **Expand** option to return the numerator and denominator of the simplified fraction in expanded form.

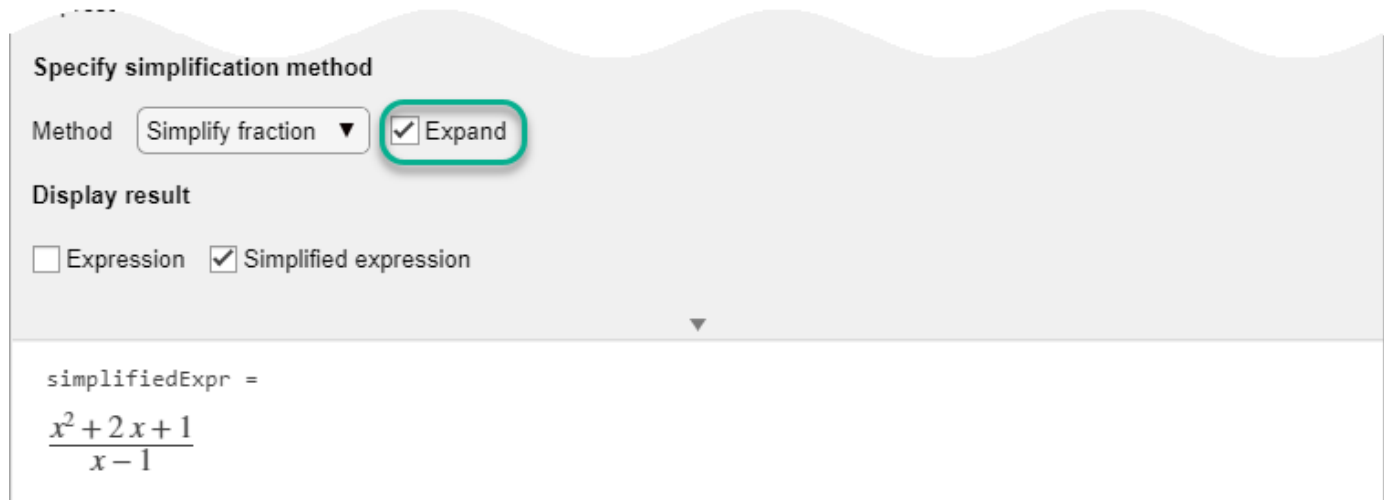

Specify simplification method

Method Expand

Display result

Expression Simplified expression

simplifiedExpr =

$$\frac{x^2 + 2x + 1}{x - 1}$$

Rewrite an Expression in a Different Form

Rewrite the trigonometric function $\tan(x)$ in terms of the sine function.

Declare $\tan(x)$ as a symbolic expression.

```
expr3 = tan(x);
```

Select the symbolic expression `expr3` from the workspace and specify the simplification method as **Rewrite**. Choose `sin` to rewrite $\tan(x)$ in terms of the sine function.

Simplify Symbolic Expression ● ⋮

`simplifiedExpr` = Compute simplified symbolic expression

Select expression

Expression expr3 ▼

Specify simplification method

Method Rewrite ▼ In terms of sin ▼

Display result

Expression Simplified expression

`simplifiedExpr` =

$$-\frac{\sin(x)}{2 \sin\left(\frac{x}{2}\right)^2 - 1}$$

Expand a Logarithmic Expression

Expand the expression $\log\left(\frac{x^3 e^x}{2}\right)$ using the logarithmic identities.

Declare the logarithmic expression as a symbolic expression.

```
expr4 = log(x^3*exp(x)/2);
```

Select the symbolic expression `expr4` from the workspace and specify the simplification method as **Expand**. By default, the symbolic variable `x` in `expr4` is complex when it is initially created. The **Expand** method does not simplify the input expression because the logarithmic identities are not valid for complex values of variables. To apply identities that are convenient but do not always hold for all values of variables, select the **Ignore analytic constraints** option.

Simplify Symbolic Expression ● ⋮

`simplifiedExpr` = Compute simplified symbolic expression

Select expression

Expression expr4 ▼

Specify simplification method

Method Expand ▼ Multiply out brackets Ignore analytic constraints

Display result

Expression Simplified expression

▼

`simplifiedExpr` = $x - \log(2) + 3 \log(x)$

Simplify the Sum of Two Integral Expressions

Simplify the sum of two integral expressions: $\int_a^b x f(x) dx + \int_a^b g(y) dy$.

First, define a and b as symbolic variables, and $f(x)$ and $g(y)$ as symbolic functions. Use the `int` function to represent the integrals.

```
syms a b f(x) g(y)
expr5 = int(x*f(x),x,a,b) + int(g(y),y,a,b);
```

Select the symbolic expression `expr5` from the workspace and specify the simplification method as **Combine**. Choose `int` as the function to combine.

Simplify Symbolic Expression ● ⋮

`simplifiedExpr3` = Compute simplified symbolic expression

Select expression

Expression expr5 ▼

Specify simplification method

Method Combine ▼ Applied to int ▼ Ignore analytic constraints

Display result

Expression Simplified expression

▼

`simplifiedExpr3` =

$$\int_a^b (g(x) + x f(x)) dx$$

Generate Code

To view the code that a task used, click ▼ at the bottom of the task window. The task displays the code block, which you can cut and paste to use or modify later in the existing script or a different program. For example:

Display result

Expression Simplified expression

▲

```
% Compute simplified symbolic expression
simplifiedExpr3 = combine(expr5,'int')
```

`simplifiedExpr3` =

$$\int_a^b (g(x) + x f(x)) dx$$

Because the underlying code is now part of your live script, you can continue to use the variables created by the task for further processing. For example, define the functions $f(x)$ and $g(x)$ as $f(x) = x$ and $g(x) = \cos(x)$. Evaluate the integrals in `simplifiedExpr3` by substituting these functions.

```
f(x) = x;  
g(x) = cos(x);  
subs(simplifiedExpr3)
```

ans =

$$\sin(b) - \sin(a) - \frac{a^3}{3} + \frac{b^3}{3}$$

See Also

Live Editor Tasks

[Simplify Symbolic Expression](#) | [Solve Symbolic Equation](#)

Functions

[combine](#) | [expand](#) | [rewrite](#) | [simplify](#) | [simplifyFraction](#)

Related Examples

- “Add Interactive Tasks to a Live Script” (MATLAB)
- “Choose Function to Rearrange Expression” on page 2-104
- [Simplify Symbolic Expression](#)

Abbreviate Common Terms in Long Expressions

Long expressions often contain several instances of the same subexpression. Such expressions look shorter if the same subexpression is replaced with an abbreviation. You can use `sympref` to specify whether or not to use abbreviated output format of symbolic expressions in live scripts.

For example, solve the equation $\sqrt{x} + \frac{1}{x} = 1$ using `solve`.

```
syms x
sols = solve(sqrt(x) + 1/x == 1, x)
```

```
sols =

$$\left( \begin{array}{l} \left( \frac{1}{18\sigma_2} + \frac{\sigma_2}{2} + \frac{1}{3} - \sigma_1 \right)^2 \\ \left( \frac{1}{18\sigma_2} + \frac{\sigma_2}{2} + \frac{1}{3} + \sigma_1 \right)^2 \end{array} \right)$$

```

where

$$\sigma_1 = \frac{\sqrt{3} \left(\frac{1}{9\sigma_2} - \sigma_2 \right) i}{2}$$

$$\sigma_2 = \left(\frac{25}{54} - \frac{\sqrt{23}\sqrt{108}}{108} \right)^{1/3}$$

The `solve` function returns exact solutions as symbolic expressions. By default, live scripts display symbolic expressions in abbreviated output format. The symbolic preference setting uses an internal algorithm to choose which subexpressions to abbreviate, which can also include nested abbreviations. For example, the term σ_1 contains the subexpression abbreviated as σ_2 . The symbolic preference setting does not provide any options to choose which subexpressions to abbreviate.

You can turn off abbreviated output format by setting the 'AbbreviateOutput' preference to `false`. The returned result is a long expression that is difficult to read.

```
sympref('AbbreviateOutput', false);
sols
```

```
sols =

$$\left( \begin{array}{l} \left( \frac{1}{18 \left( \frac{25}{54} - \frac{\sqrt{23}\sqrt{108}}{108} \right)^{1/3}} + \frac{\left( \frac{25}{54} - \frac{\sqrt{23}\sqrt{108}}{108} \right)^{1/3}}{2} + \frac{1}{3} - \frac{\sqrt{3} \left( \frac{1}{9 \left( \frac{25}{54} - \frac{\sqrt{23}\sqrt{108}}{108} \right)^{1/3}} - \left( \frac{25}{54} - \frac{\sqrt{23}\sqrt{108}}{108} \right)^{1/3} \right) i}{2} \right)^2 \\ \left( \frac{1}{18 \left( \frac{25}{54} - \frac{\sqrt{23}\sqrt{108}}{108} \right)^{1/3}} + \frac{\left( \frac{25}{54} - \frac{\sqrt{23}\sqrt{108}}{108} \right)^{1/3}}{2} + \frac{1}{3} + \frac{\sqrt{3} \left( \frac{1}{9 \left( \frac{25}{54} - \frac{\sqrt{23}\sqrt{108}}{108} \right)^{1/3}} - \left( \frac{25}{54} - \frac{\sqrt{23}\sqrt{108}}{108} \right)^{1/3} \right) i}{2} \right)^2 \end{array} \right)$$

```

The preferences you set using `sympref` persist through your current and future MATLAB® sessions. Restore the default values of 'AbbreviateOutput' by specifying the 'default' option.

```
sympref('AbbreviateOutput','default');
```

`subexpr` is another function that you can use to shorten long expressions. This function abbreviates only one common subexpression, and unlike `sympref`, it does not support nested abbreviations. Like `sympref`, `subexpr` also does not let you choose which subexpressions to replace.

Use the second input argument of `subexpr` to specify the variable name that replaces the common subexpression. For example, replace the common subexpression in `sols` with the variable `t`.

```
[sols1,t] = subexpr(sols,'t')
```

$$\text{sols1} = \begin{pmatrix} \left(\frac{t}{2} + \frac{1}{18t} + \frac{1}{3} + \frac{\sqrt{3}\left(t - \frac{1}{9t}\right) i}{2} \right)^2 \\ \left(\frac{t}{2} + \frac{1}{18t} + \frac{1}{3} - \frac{\sqrt{3}\left(t - \frac{1}{9t}\right) i}{2} \right)^2 \end{pmatrix}$$

$$t = \left(\frac{25}{54} - \frac{\sqrt{23}\sqrt{108}}{108} \right)^{1/3}$$

Although `sympref` and `subexpr` do not provide a way to choose which subexpressions to replace in a solution, you can define these subexpressions as symbolic variables and manually rewrite the solution.

For example, define new symbolic variables `a1` and `a2`.

```
syms a1 a2
```

Rewrite the solutions `sols` in terms of `a1` and `a2` before assigning the values of `a1` and `a2` to avoid evaluating `sols`.

```
sols = [(1/2*a1 + 1/3 + sqrt(3)/2*a2*1i)^2; ...
        (1/2*a1 + 1/3 - sqrt(3)/2*a2*1i)^2]
```

$$\text{sols} = \begin{pmatrix} \left(\frac{a_1}{2} + \frac{1}{3} + \frac{\sqrt{3} a_2 i}{2} \right)^2 \\ \left(\frac{a_1}{2} + \frac{1}{3} - \frac{\sqrt{3} a_2 i}{2} \right)^2 \end{pmatrix}$$

Assign the values $\left(t + \frac{1}{9t}\right)$ and $\left(t - \frac{1}{9t}\right)$ to `a1` and `a2`, respectively.

```
a1 = t + 1/(9*t)
```

$$a1 = \frac{1}{9 \left(\frac{25}{54} - \frac{\sqrt{23}\sqrt{108}}{108} \right)^{1/3}} + \left(\frac{25}{54} - \frac{\sqrt{23}\sqrt{108}}{108} \right)^{1/3}$$

$$a2 = t - 1/(9*t)$$

$$a2 =$$

$$\left(\frac{25}{54} - \frac{\sqrt{23}\sqrt{108}}{108}\right)^{1/3} - \frac{1}{9\left(\frac{25}{54} - \frac{\sqrt{23}\sqrt{108}}{108}\right)^{1/3}}$$

Evaluate `sols` using `subs`. The result is identical to the first output in this example.

$$\text{sols_eval} = \text{subs}(\text{sols})$$

$$\text{sols_eval} =$$

$$\begin{pmatrix} \left(\frac{1}{18\sigma_2} + \frac{\sigma_2}{2} + \frac{1}{3} - \sigma_1\right)^2 \\ \left(\frac{1}{18\sigma_2} + \frac{\sigma_2}{2} + \frac{1}{3} + \sigma_1\right)^2 \end{pmatrix}$$

where

$$\sigma_1 = \frac{\sqrt{3}\left(\frac{1}{9\sigma_2} - \sigma_2\right) i}{2}$$

$$\sigma_2 = \left(\frac{25}{54} - \frac{\sqrt{23}\sqrt{108}}{108}\right)^{1/3}$$

Choose Function to Rearrange Expression

Type of Transformation	Function
“Combine Terms of Same Algebraic Structures” on page 2-104	combine
“Expand Expressions” on page 2-105	expand
“Factor Expressions” on page 2-106	factor
“Extract Subexpressions from Expression” on page 2-108	children
“Collect Terms with Same Powers” on page 2-108	collect
“Rewrite Expressions in Terms of Other Functions” on page 2-109	rewrite
“Compute Partial Fraction Decompositions of Expressions” on page 2-110	partfrac
“Compute Normal Forms of Rational Expressions” on page 2-110	simplifyFraction
“Represent Polynomials Using Horner Nested Forms” on page 2-111	horner

Combine Terms of Same Algebraic Structures

Symbolic Math Toolbox provides the `combine` function for combining subexpressions of an original expression. The `combine` function uses mathematical identities for the functions you specify. For example, combine the trigonometric expression.

```
syms x y
combine(2*sin(x)*cos(x), 'sincos')

ans =
sin(2*x)
```

If you do not specify a target function, `combine` uses the identities for powers wherever these identities are valid:

- $a^b a^c = a^{b+c}$
- $a^c b^c = (a b)^c$
- $(a^b)^c = a^{bc}$

For example, by default the function combines the following square roots.

```
combine(sqrt(2)*sqrt(x))

ans =
(2*x)^(1/2)
```

The function does not combine the square roots `sqrt(x)*sqrt(y)` because the identity is not valid for negative values of variables.

```
combine(sqrt(x)*sqrt(y))
```

```
ans =
x^(1/2)*y^(1/2)
```

To combine these square roots, use the `IgnoreAnalyticConstraints` option.

```
combine(sqrt(x)*sqrt(y), 'IgnoreAnalyticConstraints', true)
```

```
ans =
(x*y)^(1/2)
```

`IgnoreAnalyticConstraints` provides a shortcut allowing you to combine expressions under commonly used assumptions about values of the variables. Alternatively, you can set appropriate assumptions on variables explicitly. For example, assume that x and y are positive values.

```
assume([x,y], 'positive')
combine(sqrt(x)*sqrt(y))
```

```
ans =
(x*y)^(1/2)
```

For further computations, clear the assumptions on x and y by recreating them using `syms`.

```
syms x y
```

As target functions, `combine` accepts `atan`, `exp`, `gamma`, `int`, `log`, `sincos`, and `sinhcosh`.

Expand Expressions

For elementary expressions, use the `expand` function to transform the original expression by multiplying sums of products. This function provides an easy way to expand polynomials.

```
expand((x - 1)*(x - 2)*(x - 3))
```

```
ans =
x^3 - 6*x^2 + 11*x - 6
```

```
expand(x*(x*(x - 6) + 11) - 6)
```

```
ans =
x^3 - 6*x^2 + 11*x - 6
```

The function also expands exponential and logarithmic expressions. For example, expand the following expression containing exponentials.

```
expand(exp(x + y)*(x + exp(x - y)))
```

```
ans =
exp(2*x) + x*exp(x)*exp(y)
```

Expand an expression containing logarithm. Expanding logarithms is not valid for generic complex values, but it is valid for positive values.

```
syms a b c positive
expand(log(a*b*c))
```

```
ans =
log(a) + log(b) + log(c)
```

For further computations, clear the assumptions.

```
syms a b c
```

Alternatively, use the `IgnoreAnalyticConstraints` option when expanding logarithms.

```
expand(log(a*b*c),'IgnoreAnalyticConstraints',true)
```

```
ans =
log(a) + log(b) + log(c)
```

`expand` also works on trigonometric expressions. For example, expand this expression.

```
expand(cos(x + y))
```

```
ans =
cos(x)*cos(y) - sin(x)*sin(y)
```

`expand` uses mathematical identities between the functions.

```
expand(sin(5*x))
```

```
ans =
sin(x) - 12*cos(x)^2*sin(x) + 16*cos(x)^4*sin(x)
```

```
expand(cos(3*acos(x)))
```

```
ans =
4*x^3 - 3*x
```

`expand` works recursively for all subexpressions.

```
expand((sin(3*x) + 1)*(cos(2*x) - 1))
```

```
ans =
2*sin(x) + 2*cos(x)^2 - 10*cos(x)^2*sin(x) + 8*cos(x)^4*sin(x) - 2
```

To prevent the expansion of all trigonometric, logarithmic, and exponential subexpressions, use the option `ArithmeticOnly`.

```
expand(exp(x + y)*(x + exp(x - y)),'ArithmeticOnly',true)
```

```
ans =
exp(x - y)*exp(x + y) + x*exp(x + y)
```

```
expand((sin(3*x) + 1)*(cos(2*x) - 1),'ArithmeticOnly',true)
```

```
ans =
cos(2*x) - sin(3*x) + cos(2*x)*sin(3*x) - 1
```

Factor Expressions

To return all irreducible factors of an expression, use the `factor` function. For example, find all irreducible polynomial factors of this polynomial expression. The result shows that this polynomial has three roots: $x = 1$, $x = 2$, and $x = 3$.

```
syms x
factor(x^3 - 6*x^2 + 11*x - 6)
```

```
ans =
[ x - 3, x - 1, x - 2]
```

If a polynomial expression is irreducible, `factor` returns the original expression.

```
factor(x^3 - 6*x^2 + 11*x - 5)
```

```
ans =
x^3 - 6*x^2 + 11*x - 5
```

Find irreducible polynomial factors of the expression $x^6 + 1$. By default, `factor` uses factorization over rational numbers keeping rational numbers in their exact symbolic form. The resulting factors for this expression do not show polynomial roots.

```
factor(x^6 + 1)
```

```
ans =
[ x^2 + 1, x^4 - x^2 + 1]
```

Using other factorization modes lets you factor this expression further. For example, factor the same expression over complex numbers.

```
factor(x^6 + 1, 'FactorMode', 'complex')
```

```
ans =
[ x + 0.86602540378443864676372317075294 + 0.5i, ...
  x + 0.86602540378443864676372317075294 - 0.5i, ...
  x + 1.0i, ...
  x - 1.0i, ...
  x - 0.86602540378443864676372317075294 + 0.5i, ...
  x - 0.86602540378443864676372317075294 - 0.5i]
```

`factor` also works on expressions other than polynomials and rational expressions. For example, you can factor the following expression that contains logarithm, sine, and cosine functions. Internally, `factor` converts such expressions into polynomials and rational expressions by substituting subexpressions with variables. After computing irreducible factors, the function restores original subexpressions.

```
factor((log(x)^2 - 1)/(cos(x)^2 - sin(x)^2))
```

```
ans =
[ log(x) - 1, log(x) + 1, 1/(cos(x) - sin(x)), 1/(cos(x) + sin(x))]
```

Use `factor` to factor symbolic integers and symbolic rational numbers.

```
factor(sym(902834092))
factor(1/sym(210))
```

```
ans =
[ 2, 2, 47, 379, 12671]
```

```
ans =
[ 1/2, 1/3, 1/5, 1/7]
```

`factor` also can factor numbers larger than `flintmax` that the MATLAB `factor` cannot. To represent a large number accurately, place the number in quotation marks.

```
factor(sym('41758540882408627201'))
```

```
ans =
[ 479001599, 87178291199]
```

Extract Subexpressions from Expression

The `children` function returns the subexpressions of an expression.

Define an expression `f` with several subexpressions.

```
syms x y
f = exp(3*x)*y^3 + exp(2*x)*y^2 + exp(x)*y;
```

Extract the subexpressions of `f` by using `children`.

```
expr = children(f)

expr =
[ y^2*exp(2*x), y^3*exp(3*x), y*exp(x) ]
```

You can extract lower-level subexpressions by calling `children` repeatedly on the results.

Extract the subexpressions of `expr(1)` by calling `children` repeatedly. When the input to `children` is a vector, the output is a cell array.

```
expr1 = children(expr(1))
expr2 = children(expr1)

expr1 =
[ y^2, exp(2*x) ]
expr2 =
    1x2 cell array
    {1x2 sym}    {1x1 sym}
```

Access the contents of the cell array `expr2` using braces.

```
expr2{1}
expr2{2}

ans =
[ y, 2]
ans =
2*x
```

Collect Terms with Same Powers

If a mathematical expression contains terms with the same powers of a specified variable or expression, the `collect` function reorganizes the expression by grouping such terms. When calling `collect`, specify the variables that the function must consider as unknowns. The `collect` function regards the original expression as a polynomial in the specified unknowns, and groups the coefficients with equal powers. Group the terms of an expression with the equal powers of `x`.

```
syms x y z
expr = x*y^4 + x*z + 2*x^3 + x^2*y*z + ...
      3*x^3*y^4*z^2 + y*z^2 + 5*x*y*z;
collect(expr, x)

ans =
(3*y^4*z^2 + 2)*x^3 + y*z*x^2 + (y^4 + 5*z*y + z)*x + y*z^2
```

Group the terms of the same expression with the equal powers of `y`.

```
collect(expr, y)
```

```
ans =
(3*x^3*z^2 + x)*y^4 + (x^2*z + 5*x*z + z^2)*y + 2*x^3 + z*x
```

Group the terms of the same expression with the equal powers of z.

```
collect(expr, z)
```

```
ans =
(3*x^3*y^4 + y)*z^2 + (x + 5*x*y + x^2*y)*z + 2*x^3 + x*y^4
```

If you do not specify variables that `collect` must consider as unknowns, the function uses `symvar` to determine the default variable.

```
collect(expr)
```

```
ans =
(3*y^4*z^2 + 2)*x^3 + y*z*x^2 + (y^4 + 5*z*y + z)*x + y*z^2
```

Collect terms of an expression with respect to several unknowns by specifying those unknowns as a vector.

```
collect(expr, [y,z])
```

```
ans =
3*x^3*y^4*z^2 + x*y^4 + y*z^2 + (x^2 + 5*x)*y*z + x*z + 2*x^3
```

Rewrite Expressions in Terms of Other Functions

To present an expression in terms of a particular function, use `rewrite`. This function uses mathematical identities between functions. For example, rewrite an expression containing trigonometric functions in terms of a particular trigonometric function.

```
syms x
rewrite(sin(x), 'tan')
```

```
ans =
(2*tan(x/2))/(tan(x/2)^2 + 1)
```

```
rewrite(cos(x), 'tan')
```

```
ans =
-(tan(x/2)^2 - 1)/(tan(x/2)^2 + 1)
```

```
rewrite(sin(2*x) + cos(3*x)^2, 'tan')
```

```
ans =
(tan((3*x)/2)^2 - 1)^2/(tan((3*x)/2)^2 + 1)^2 + ...
(2*tan(x))/(tan(x)^2 + 1)
```

Use `rewrite` to express these trigonometric functions in terms of the exponential function.

```
rewrite(sin(x), 'exp')
```

```
ans =
(exp(-x*1i)*1i)/2 - (exp(x*1i)*1i)/2
```

```
rewrite(cos(x), 'exp')
```

```
ans =
exp(-x*1i)/2 + exp(x*1i)/2
```

Use `rewrite` to express these hyperbolic functions in terms of the exponential function.

```
rewrite(sinh(x), 'exp')
```

```
ans =
exp(x)/2 - exp(-x)/2
```

```
rewrite(cosh(x), 'exp')
```

```
ans =
exp(-x)/2 + exp(x)/2
```

`rewrite` also expresses inverse hyperbolic functions in terms of logarithms.

```
rewrite(asinh(x), 'log')
```

```
ans =
log(x + (x^2 + 1)^(1/2))
```

```
rewrite(acosh(x), 'log')
```

```
ans =
log(x + (x - 1)^(1/2)*(x + 1)^(1/2))
```

Compute Partial Fraction Decompositions of Expressions

The `partfrac` function returns a rational expression in the form of a sum of a polynomial and rational terms. In each rational term, the degree of the numerator is smaller than the degree of the denominator. For some expressions, `partfrac` returns visibly simpler forms.

```
syms x
n = x^6 + 15*x^5 + 94*x^4 + 316*x^3 + 599*x^2 + 602*x + 247;
d = x^6 + 14*x^5 + 80*x^4 + 238*x^3 + 387*x^2 + 324*x + 108;
partfrac(n/d, x)
```

```
ans =
1/(x + 1) + 1/(x + 2)^2 + 1/(x + 3)^3 + 1
```

The denominators in rational terms represent the factored common denominator of the original expression.

```
factor(d)
```

```
ans =
[ x + 1, x + 2, x + 2, x + 3, x + 3, x + 3]
```

Compute Normal Forms of Rational Expressions

The `simplifyFraction` function represents the original rational expression as a single rational term with expanded numerator and denominator. The greatest common divisor of the numerator and denominator of the returned expression is 1. This function is more efficient for simplifying fractions than the `simplify` function.

```
syms x y
simplifyFraction((x^3 + 3*y^2)/(x^2 - y^2) + 3)
```

```
ans =
(x^3 + 3*x^2)/(x^2 - y^2)
```

`simplifyFraction` cancels common factors that appear in numerator and denominator.

```
simplifyFraction(x^2/(x + y) - y^2/(x + y))
```

```
ans =
x - y
```

`simplifyFraction` also handles expressions other than polynomials and rational functions. Internally, it converts such expressions into polynomials or rational functions by substituting subexpressions with identifiers. After normalizing the expression with temporary variables, `simplifyFraction` restores the original subexpressions.

```
simplifyFraction((exp(2*x) - exp(2*y))/(exp(x) - exp(y)))
```

```
ans =
exp(x) + exp(y)
```

Represent Polynomials Using Horner Nested Forms

The Horner, or nested, form of a polynomial expression is efficient for numerical evaluation because it often involves fewer arithmetical operations compared to other mathematically equivalent forms of the same polynomial. Typically, this form of an expression is numerically stable. To represent a polynomial expression in a nested form, use the `horner` function.

```
syms x
horner(x^3 - 6*x^2 + 11*x - 6)
```

```
ans =
x*(x*(x - 6) + 11) - 6
```

If polynomial coefficients are floating-point numbers, the resulting Horner form represents them as rational numbers.

```
horner(1.1 + 2.2*x + 3.3*x^2)
```

```
ans =
x*((33*x)/10 + 11/5) + 11/10
```

To convert the coefficients in the result to floating-point numbers, use `vpa`.

```
vpa(ans)
```

```
ans =
x*(3.3*x + 2.2) + 1.1
```

Clear Assumptions and Reset the Symbolic Engine

The symbolic engine workspace associated with the MATLAB workspace is usually empty. The MATLAB workspace tracks the values of symbolic variables, and passes them to the symbolic engine for evaluation as necessary. However, the symbolic engine workspace contains all assumptions you make about symbolic variables, such as whether a variable is real, positive, integer, greater or less than a certain value, and so on. These assumptions can affect solutions to equations, simplifications, and transformations, as explained in “Effects of Assumptions on Computations” on page 2-114.

For example, create a symbolic variable x and assume that it is positive.

```
syms x
assume(x > 0)
```

If you clear the variable x using the command `clear x`, the MATLAB workspace does not clear the assumption from the symbolic engine workspace.

```
clear x
assumptions
```

```
ans =
0 < x
```

To clear the assumption for the variable x , use the command `assume(x, 'clear')`.

```
syms x
assume(x > 0)
assume(x, 'clear')
assumptions
```

```
ans =
Empty sym: 1-by-0
```

Alternatively, you can create a fresh symbolic variable without assumptions using `syms`.

```
syms x
```

If you want to clear a symbolic variable and also reset the symbolic engine, use the command `clear all`.

```
syms x positive
clear all
whos
assumptions
```

```
ans =
Empty sym: 1-by-0
```

The following shows how the MATLAB workspace and symbolic engine workspace differ in their responses to a sequence of commands.

Step	Command	MATLAB Workspace	Symbolic Engine Workspace
1	<pre>syms x positive or syms x; assume(x > 0)</pre>	x	$x > 0$

Step	Command	MATLAB Workspace	Symbolic Engine Workspace
2	<code>clear x</code>	empty	$x > 0$
3	<code>syms x</code>	x	empty
4	<code>clear all</code>	empty	empty

Check Assumptions Set on Variables

To check whether a variable, say x , has any assumptions in the symbolic engine workspace associated with the MATLAB workspace, use the `assumptions` function in the MATLAB Live Editor:

```
assumptions(x)
```

If the function returns an empty symbolic object, there are no additional assumptions on the variable. The default assumption is that x represents any complex number. Otherwise, there are additional assumptions on the value that the variable represents.

For example, while declaring the symbolic variable x , make an assumption that the value of this variable is a real number.

```
syms x real
assumptions(x)
```

```
ans =
in(x, 'real')
```

Another way to set an assumption is to use the `assume` function.

```
syms z
assume(z ~= 0);
assumptions(z)
```

```
ans =
z ~= 0
```

To see assumptions set on all variables in the MATLAB workspace, use `assumptions` without input arguments.

```
assumptions
```

```
ans =
[ in(x, 'real'), z ~= 0]
```

Clear assumptions set on x and z .

```
assume([x z], 'clear')
```

```
assumptions
```

```
ans =
Empty sym: 1-by-0
```

Equivalently, the following command also clears assumptions from x and z .

```
syms x z
```

Effects of Assumptions on Computations

Assumptions can affect many computations, including results returned by the `solve` and `simplify` functions. For example, solve this equation without any additional assumptions on its variable.

```
syms x
solve(x^4 == 1, x)

ans =
-1
 1
-1i
 1i
```

Now assume that x is real and solve the same equation.

```
syms x real
solve(x^4 == 1, x)

ans =
-1
 1
```

Use the `assumeAlso` function to add the assumption that x is also positive.

```
assumeAlso(x > 0)
solve(x^4 == 1, x)

ans =
 1
```

Clearing x does not change the underlying assumptions that x is real and positive.

```
clear x
x = sym('x');
assumptions(x)
solve(x^4 == 1, x)

ans =
[ in(x, 'real'), 0 < x]
ans =
 1
```

Clearing x with `assume(x, 'clear')` or `syms x` clears the assumptions.

```
syms x
assumptions(x)

ans =
Empty sym: 1-by-0
```

Extract Numerators and Denominators of Rational Expressions

To extract the numerator and denominator of a rational symbolic expression, use the `numden` function. The first output argument of `numden` is a numerator, the second output argument is a denominator. Use `numden` to find numerators and denominators of symbolic rational numbers.

```
[n,d] = numden(1/sym(3))
```

```
n =  
1
```

```
d =  
3
```

Use `numden` to find numerators and denominators of a symbolic expressions.

```
syms x y  
[n,d] = numden((x^2 - y^2)/(x^2 + y^2))
```

```
n =  
x^2 - y^2
```

```
d =  
x^2 + y^2
```

Use `numden` to find numerators and denominators of symbolic functions. If the input is a symbolic function, `numden` returns the numerator and denominator as symbolic functions.

```
syms f(x) g(x)  
f(x) = sin(x)/x^2;  
g(x) = cos(x)/x;  
[n,d] = numden(f)
```

```
n(x) =  
sin(x)
```

```
d(x) =  
x^2
```

```
[n,d] = numden(f/g)
```

```
n(x) =  
sin(x)
```

```
d(x) =  
x*cos(x)
```

`numden` converts the input to its one-term rational form, such that the greatest common divisor of the numerator and denominator is 1. Then it returns the numerator and denominator of that form of the expression.

```
[n,d] = numden(x/y + y/x)
```

```
n =  
x^2 + y^2
```

```
d =  
x*y
```

`numden` works on vectors and matrices. If an input is a vector or matrix, `numden` returns two vectors or two matrices of the same size as the input. The first vector or matrix contains numerators of each element. The second vector or matrix contains denominators of each element. For example, find numerators and denominators of each element of the 3-by-3 Hilbert matrix.

```
H = sym(hilb(3))
```

```
H =  
[ 1, 1/2, 1/3]  
[ 1/2, 1/3, 1/4]  
[ 1/3, 1/4, 1/5]
```

```
[n,d] = numden(H)
```

```
n =  
[ 1, 1, 1]  
[ 1, 1, 1]  
[ 1, 1, 1]
```

```
d =  
[ 1, 2, 3]  
[ 2, 3, 4]  
[ 3, 4, 5]
```

Substitute Variables in Symbolic Expressions

Solve the following trigonometric equation using the `ReturnConditions` option of the solver to obtain the complete solution. The solver returns the solution, parameters used in the solution, and conditions on those parameters.

```
syms x
eqn = sin(2*x) + cos(x) == 0;
[solx, params, conds] = solve(eqn, x, 'ReturnConditions', true)

solx =
    pi/2 + pi*k
    2*pi*k - pi/6
    (7*pi)/6 + 2*pi*k

params =
    k

conds =
    in(k, 'integer')
    in(k, 'integer')
    in(k, 'integer')
```

Replace the parameter `k` with a new symbolic variable `a`. First, create symbolic variables `k` and `a`. (The solver does not create variable `k` in the MATLAB workspace.)

```
syms k a
```

Now, use the `subs` function to replace `k` by `a` in the solution vector `solx`, parameters `params`, and conditions `conds`.

```
solx = subs(solx, k, a)
params = subs(params, k, a)
conds = subs(conds, k, a)

solx =
    pi/2 + pi*a
    2*pi*a - pi/6
    (7*pi)/6 + 2*pi*a
params =
    a
conds =
    in(a, 'integer')
    in(a, 'integer')
    in(a, 'integer')
```

Suppose, you know that the value of the parameter `a` is 2. Substitute `a` with 2 in the solution vector `solx`.

```
subs(solx, a, 2)
```

```
ans =
    (5*pi)/2
    (23*pi)/6
    (31*pi)/6
```

Alternatively, substitute `params` with 2. This approach returns the same result.

```
subs(solx, params, 2)
```

```
ans =  
  (5*pi)/2  
  (23*pi)/6  
  (31*pi)/6
```

Substitute parameter `a` with a floating-point number. The toolbox converts numbers to floating-point values, but it keeps intact the symbolic expressions, such as `sym(pi)`, `exp(sym(1))`, and so on.

```
subs(solx, params, vpa(2))
```

```
ans =  
                                         2.5*pi  
  3.8333333333333333333333333333333333333333333*pi  
  5.1666666666666666666666666666666666666666667*pi
```

Approximate the result of substitution with floating-point values by using `vpa` on the result returned by `subs`.

```
vpa(subs(solx, params, 2))
```

```
ans =  
  7.8539816339744830961566084581988  
  12.042771838760874080773466302571  
  16.231562043547265065390324146944
```

Substitute Elements in Symbolic Matrices

Create a 2-by-2 matrix A with automatically generated elements using `sym`. The generated elements $A_{1,1}$, $A_{1,2}$, $A_{2,1}$, and $A_{2,2}$ do not appear in the MATLAB® workspace.

```
A = sym('A', [2 2])
```

$$A = \begin{pmatrix} A_{1,1} & A_{1,2} \\ A_{2,1} & A_{2,2} \end{pmatrix}$$

Substitute the element $A_{1,2}$ with a value 5. Assign the value directly by indexing into the matrix element.

```
A(1,2) = 5
```

$$A = \begin{pmatrix} A_{1,1} & 5 \\ A_{2,1} & A_{2,2} \end{pmatrix}$$

Alternatively, you can create a 2-by-2 matrix using `syms`. Create a matrix B using `syms`.

```
syms B [2 2]
B
```

$$B = \begin{pmatrix} B_{1,1} & B_{1,2} \\ B_{2,1} & B_{2,2} \end{pmatrix}$$

The generated elements $B_{1,1}$, $B_{1,2}$, $B_{2,1}$, and $B_{2,2}$ appear as symbolic variables `B1_1`, `B1_2`, `B2_1`, and `B2_2` in the MATLAB workspace. Use `subs` to substitute the element of B by specifying the variable name. For example, substitute `B2_2` with 4.

```
B = subs(B, B2_2, 4)
```

$$B = \begin{pmatrix} B_{1,1} & B_{1,2} \\ B_{2,1} & 4 \end{pmatrix}$$

You can also create a matrix by specifying the elements individually. Create a 3-by-3 circulant matrix M.

```
syms a b c
M = [a b c; b c a; c a b]
```

$$M = \begin{pmatrix} a & b & c \\ b & c & a \\ c & a & b \end{pmatrix}$$

Replace variable `b` in the matrix M by the expression `a + 1`. The `subs` function replaces all `b` elements in matrix M with the expression `a + 1`.

```
M = subs(M, b, a+1)
```

$$M = \begin{pmatrix} a & a+1 & c \\ a+1 & c & a \\ c & a & a+1 \end{pmatrix}$$

Next, replace all elements whose value is c with $a + 2$. You can specify the value to replace as c , $M(1,3)$ or $M(3,1)$.

$$M = \text{subs}(M, M(1,3), a+2)$$

$$M = \begin{pmatrix} a & a+1 & a+2 \\ a+1 & a+2 & a \\ a+2 & a & a+1 \end{pmatrix}$$

To replace a particular element of a matrix with a new value while keeping all other elements unchanged, use the assignment operation. For example, $M(1,1) = 2$ replaces only the first element of the matrix M with the value 2.

Find eigenvalues and eigenvectors of the matrix M .

$$[V, E] = \text{eig}(M)$$

$$V = \begin{pmatrix} 1 & \frac{\sqrt{3}}{2} - \frac{1}{2} & -\frac{\sqrt{3}}{2} - \frac{1}{2} \\ 1 & -\frac{\sqrt{3}}{2} - \frac{1}{2} & \frac{\sqrt{3}}{2} - \frac{1}{2} \\ 1 & 1 & 1 \end{pmatrix}$$

$$E = \begin{pmatrix} 3a+3 & 0 & 0 \\ 0 & \sqrt{3} & 0 \\ 0 & 0 & -\sqrt{3} \end{pmatrix}$$

Replace the symbolic parameter a with the value 1.

$$\text{subs}(E, a, 1)$$

$$\text{ans} = \begin{pmatrix} 6 & 0 & 0 \\ 0 & \sqrt{3} & 0 \\ 0 & 0 & -\sqrt{3} \end{pmatrix}$$

Substitute Scalars with Matrices

Create the following expression representing the sine function.

```
syms w t
f = sin(w*t);
```

Suppose, your task involves creating a matrix whose elements are sine functions with angular velocities represented by a Toeplitz matrix. First, create a 4-by-4 Toeplitz matrix.

```
W = toeplitz(sym([3 2 1 0]))
```

```
W =
[ 3, 2, 1, 0]
[ 2, 3, 2, 1]
[ 1, 2, 3, 2]
[ 0, 1, 2, 3]
```

Next, replace the variable w in the expression f with the Toeplitz matrix W . When you replace a scalar in a symbolic expression with a matrix, `subs` expands the expression into a matrix. In this example, `subs` expands $f = \sin(w*t)$ into a 4-by-4 matrix whose elements are $\sin(w*t)$. Then it replaces w in that matrix with the corresponding elements of the Toeplitz matrix W .

```
F = subs(f, w, W)
```

```
F =
[ sin(3*t), sin(2*t), sin(t), 0]
[ sin(2*t), sin(3*t), sin(2*t), sin(t)]
[ sin(t), sin(2*t), sin(3*t), sin(2*t)]
[ 0, sin(t), sin(2*t), sin(3*t)]
```

Find the sum of these sine waves at $t = \pi$, $t = \pi/2$, $t = \pi/3$, $t = \pi/4$, $t = \pi/5$, and $t = \pi/6$. First, find the sum of all elements of matrix F . Here, the first call to `sum` returns a row vector containing sums of elements in each column. The second call to `sum` returns the sum of elements of that row vector.

```
S = sum(sum(F))
```

```
S =
6*sin(2*t) + 4*sin(3*t) + 4*sin(t)
```

Now, use `subs` to evaluate S for particular values of the variable t .

```
subs(S, t, sym(pi)./[1:6])
```

```
[ 0, ...
 0, ...
 5*3^(1/2), 4*2^(1/2) + 6, ...
 2^(1/2)*(5 - 5^(1/2))^(1/2) + (5*2^(1/2)*(5^(1/2) + 5)^(1/2))/2, ...
 3*3^(1/2) + 6]
```

You also can use `subs` to replace a scalar element of a matrix with another matrix. In this case, `subs` expands the matrix to accommodate new elements. For example, replace zero elements of the matrix F with a column vector $[1; 2]$. The original 4-by-4 matrix F expands to an 8-by-4 matrix. The `subs` function duplicates each row of the original matrix, not only the rows containing zero elements.

```
F = subs(F, 0, [1;2])
```

```
F =  
[ sin(3*t), sin(2*t), sin(t), 1]  
[ sin(3*t), sin(2*t), sin(t), 2]  
[ sin(2*t), sin(3*t), sin(2*t), sin(t)]  
[ sin(2*t), sin(3*t), sin(2*t), sin(t)]  
[ sin(t), sin(2*t), sin(3*t), sin(2*t)]  
[ sin(t), sin(2*t), sin(3*t), sin(2*t)]  
[ 1, sin(t), sin(2*t), sin(3*t)]  
[ 2, sin(t), sin(2*t), sin(3*t)]
```

Evaluate Symbolic Expressions Using subs

When you assign a value to a symbolic variable, expressions containing the variable are not automatically evaluated. Instead, evaluate expressions by using `subs`.

Define the expression $y = x^2$.

```
syms x  
y = x^2;
```

Assign 2 to `x`. The value of `y` is still x^2 instead of 4.

```
x = 2;  
y
```

```
y =  
x^2
```

If you change the value of `x` again, the value of `y` stays x^2 . Instead, evaluate `y` with the new value of `x` by using `subs`.

```
subs(y)
```

```
ans =  
4
```

The evaluated result is 4. However, `y` has not changed. Change the value of `y` by assigning the result to `y`.

```
y = subs(y)
```

```
y =  
4
```

Show that `y` is independent of `x` after this assignment.

```
x = 5;  
subs(y)
```

```
ans =  
4
```

Choose Numeric or Symbolic Arithmetic

Symbolic Math Toolbox operates on numbers by using either numeric or symbolic arithmetic. In numeric arithmetic, you represent numbers in floating-point format using either double precision or variable precision. In symbolic arithmetic, you represent numbers in their exact form. This topic compares double-precision, variable-precision, and symbolic arithmetic.

Double-Precision Arithmetic

Numeric computations in MATLAB use double-precision arithmetic by default. For example, evaluate the expressions $10001/1001$, π , and $\sqrt{2}$. The results are converted to double-precision values.

```
x = 10001/1001
y = pi
z = sqrt(2)
```

```
x =
    9.9910
```

```
y =
    3.1416
```

```
z =
    1.4142
```

For more information about double-precision arithmetic, see “Floating-Point Numbers” (MATLAB). This arithmetic is recommended when you do not have Symbolic Math Toolbox or are using functions that do not accept symbolic input. Otherwise, exact symbolic arithmetic and variable-precision arithmetic are recommended. To convert a symbolic value to double precision, use the `double` function.

Variable-Precision Arithmetic

Variable-precision arithmetic using `vpa` is the recommended approach for numeric calculations in Symbolic Math Toolbox. You can specify the number of significant digits when performing calculations with variable-precision arithmetic.

For example, use `vpa` to evaluate the fraction $10001/1001$. By default, `vpa` evaluates inputs to 32 significant digits. Approximate the fraction $10001/1001$ to at least 32 significant digits.

```
vpa(10001/1001)
```

```
ans =
9.991008991008991008991008991009
```

Approximate the fraction to at least 8 significant digits. Change the number of significant digits by using the `digits` function.

```
digits(8);
vpa(10001/1001)
```

```
ans =
9.991009
```

In variable-precision arithmetic, you can increase the number of significant digits on page 2-128 for greater precision. Alternatively, you can decrease the number of significant digits on page 2-134 for faster computations and decreased memory usage.

Symbolic Arithmetic

Symbolic Math Toolbox provides the `sym` and `syms` functions to perform exact symbolic computations on page 1-11. In symbolic arithmetic, you can perform computations involving numbers and variables in their exact form, such as $x/2$, $2^{(1/2)}$, or `pi`. The following three examples show several calculations that are performed in symbolic arithmetic.

Express Irrational Numbers

Use `sym` to create symbolic numbers. Express the irrational numbers π and $\sqrt{2}$ in symbolic form.

```
x = sym(pi)
y = sqrt(sym(2))

x =
pi

y =
2^(1/2)
```

Perform Calculations with Large Integers

When you declare a number, MATLAB automatically converts the number to double precision. For example, declare the integer 80435758145817515 as the input argument of `sym`. The number loses its accuracy since it is bigger than the largest consecutive integer `flintmax` in double precision, which is 2^{53} .

```
Z = 80435758145817515
Zinaccurate = sym(80435758145817515)

Z =
      8.0436e+16

Zinaccurate =
80435758145817520
```

To declare a large integer as symbolic number accurately, use a character vector with single quotation marks as the input argument of `sym`.

```
Zaccurate = sym('80435758145817515')

Zaccurate =
80435758145817515
```

You can then perform calculations with large integers using symbolic arithmetic accurately. For example, evaluate the sum of the cubes of three large integers.

```
Z1 = sym('80435758145817515')
Z2 = sym('12602123297335631')
Z3 = sym('-80538738812075974')
Zsum = Z1^3 + Z2^3 + Z3^3

Z1 =
80435758145817515
```

```
Z2 =
12602123297335631

Z3 =
-80538738812075974

Zsum =
42
```

Solve Mathematical Equations

With symbolic arithmetic, you can solve a mathematical equation. For example, solve the quadratic equation $ax^2 + bx + c = 0$. Use `syms` to declare the variable x and the quadratic coefficients a , b , and c .

```
syms a b c x
eqn = a*x^2 + b*x + c == 0;
```

Find the solutions using `solve` and return them as symbolic expressions.

```
sols = solve(eqn,x)

sols =
-(b + (b^2 - 4*a*c)^(1/2))/(2*a)
-(b - (b^2 - 4*a*c)^(1/2))/(2*a)
```

Use `subs` to substitute symbolic values for the coefficients. Set $a = 1$, $b = 2$, and $c = 3$. Return the solutions of the quadratic equation as symbolic numbers.

```
solsSym = subs(sols,[a b c],[1 2 3])

solsSym =
-(8^(1/2)*1i)/2 - 1
(8^(1/2)*1i)/2 - 1
```

You can then convert the symbolic solutions to floating-point format in double precision or variable precision.

```
digits(32);
solsDouble = double(solsSym)
solsVpa = vpa(solsSym)

solsDouble =
-1.0000 - 1.4142i
-1.0000 + 1.4142i

solsVpa =
- 1.0 - 1.4142135623730950488016887242097i
- 1.0 + 1.4142135623730950488016887242097i
```

Comparisons of Numeric and Symbolic Arithmetic

The table below compares double-precision, variable-precision, and symbolic arithmetic.

	Double Precision	Variable Precision	Symbolic
Example 1: Evaluate $\sin(\pi)$	<pre>a = pi sin(pi) a = 3.1416 ans = 1.2246e-16</pre>	<pre>b = vpa(pi) sin(b) b = 3.1415926535897932384626433832795 ans = -3.2101083013100396069547145883568e-40</pre>	<pre>c = sym(pi) sin(c) c = pi ans = 47145883568e-40</pre>
Example 2: Evaluate $1 - 3*(4/3 - 1)$	<pre>a = 4/3 1 - 3*(a - 1) a = 1.3333 ans = 2.2204e-16</pre>	<pre>digits(16); b = vpa(4/3) 1 - 3*(b - 1) b = 1.3333333333333333 ans = 3.308722450212111e-24</pre>	<pre>c = sym(4)/3 1 - 3*(c - 1) c = 4/3 ans = 0</pre>
Functions Used	double	vpa digits	sym
Data Type	double	sym	sym
Round-Off Errors	Yes, the answer has 16 digits of precision.	Yes, the number of digits depends on the precision used.	No, the results are exact.
Speed	Faster	Faster, depending on the precision used	Slowest
Memory Usage	Least	Variable, depending on the precision used	Greatest

See Also

More About

- “Numeric to Symbolic Conversion” on page 2-136
- “Increase Precision of Numeric Calculations” on page 2-128
- “Numerical Computations With High Precision”

Increase Precision of Numeric Calculations

By default, MATLAB uses 16 digits of precision. For higher precision, use the `vpa` function in Symbolic Math Toolbox. `vpa` provides variable precision which can be increased without limit.

When you choose variable-precision arithmetic, by default, `vpa` uses 32 significant decimal digits of precision. For details, see “Choose Numeric or Symbolic Arithmetic” on page 2-124. You can set a higher precision by using the `digits` function.

Approximate a sum using the default precision of 32 digits. If at least one input is wrapped with `vpa`, all other inputs are converted to variable precision automatically.

```
vpa(1/3) + 1/2
ans =
0.83333333333333333333333333333333
```

You must wrap all inner inputs with `vpa`, such as `exp(vpa(200))`. Otherwise, the inputs are automatically converted to double by MATLAB.

Increase the precision to 50 digits by using `digits` and save the old value of `digits` in `digitsOld`. Repeat the sum.

```
digitsOld = digits(50);
sum50 = vpa(1/3) + 1/2
sum50 =
0.8333333333333333333333333333333333333333333333333333333333333333
```

Restore the old value of `digits` for further calculations.

```
digits(digitsOld)
```

Note `vpa` output is symbolic. To use symbolic output with a MATLAB function that does not accept symbolic values, convert symbolic values to double precision by using `double`.

Check the current `digits` setting by calling `digits`.

```
digits
Digits = 32
```

Change the precision for a single `vpa` call by specifying the precision as the second input to `vpa`. This call does not affect `digits`. For example, approximate `pi` with 100 digits.

```
vpa(pi,100)
ans =
3.14159265358979323846264338327950288419716939937510582097494
4592307816406286208998628034825342117068
digits % digits remains 32
Digits = 32
```

Variable precision can be increased arbitrarily. Find `pi` to 500 digits.

```
digitsOld = digits(500);  
vpa(pi)  
digits(digitsOld)  
  
ans =  
3.1415926535897932384626433832795028841971693993751058209749  
445923078164062862089986280348253421170679821480865132823066  
470938446095505822317253594081284811174502841027019385211055  
596446229489549303819644288109756659334461284756482337867831  
652712019091456485669234603486104543266482133936072602491412  
737245870066063155881748815209209628292540917153643678925903  
600113305305488204665213841469519415116094330572703657595919  
530921861173819326117931051185480744623799627495673518857527  
248912279381830119491
```

`digits` and `vpa` control the number of *significant* decimal digits. For example, approximating $1/111$ with four-digit accuracy returns six digits after the decimal point because the first two digits are zeros.

```
vpa(1/111,4)
```

```
ans =  
0.009009
```

Note If you want to increase performance by *decreasing* precision, see “Increase Speed by Reducing Precision” on page 2-134.

Recognize and Avoid Round-Off Errors

When approximating a value numerically, remember that floating-point results can be sensitive to the precision used. Also, floating-point results are prone to round-off errors. The following approaches can help you recognize and avoid incorrect results.

In this section...

“Use Symbolic Computations When Possible” on page 2-130

“Perform Calculations with Increased Precision” on page 2-130

“Compare Symbolic and Numeric Results” on page 2-132

“Plot the Function or Expression” on page 2-132

Use Symbolic Computations When Possible

Performing computations symbolically on page 2-124 is recommended because exact symbolic computations are not prone to round-off errors. For example, standard mathematical constants have their own symbolic representations in Symbolic Math Toolbox:

```
pi
sym(pi)

ans =
    3.1416

ans =
    pi
```

Avoid unnecessary use of numeric approximations. A floating-point number approximates a constant; it is not the constant itself. Using this approximation, you can get incorrect results. For example, the `heaviside` special function returns different results for the sine of `sym(pi)` and the sine of the numeric approximation of `pi`:

```
heaviside(sin(sym(pi)))
heaviside(sin(pi))

ans =
    1/2

ans =
    1
```

Perform Calculations with Increased Precision

The Riemann hypothesis states that all nontrivial zeros of the Riemann Zeta function $\zeta(z)$ have the same real part $\Re(z) = 1/2$. To locate possible zeros of the Zeta function, plot its absolute value $|\zeta(1/2 + iy)|$. The following plot shows the first three nontrivial roots of the Zeta function $|\zeta(1/2 + iy)|$.

```
syms y
fplot(abs(zeta(1/2 + i*y)), [0 30])
```

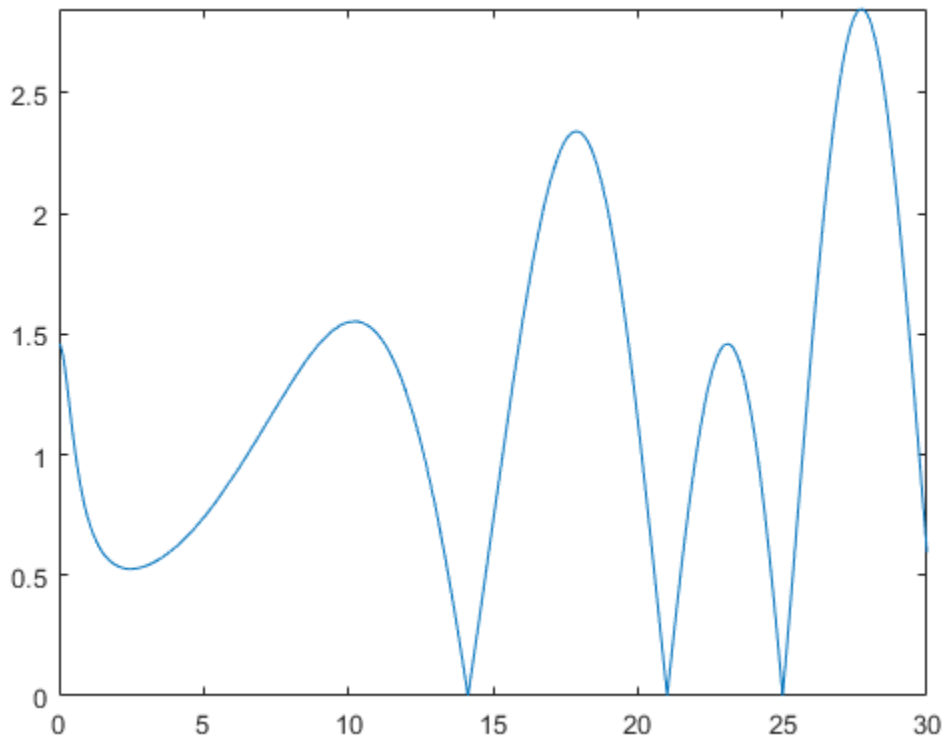

Use the numeric solver `vpasolve` to approximate the first three zeros of this Zeta function:

```
vpasolve(zeta(1/2 + i*y), y, 15)
vpasolve(zeta(1/2 + i*y), y, 20)
vpasolve(zeta(1/2 + i*y), y, 25)
```

```
ans =
14.134725141734693790457251983562
```

```
ans =
21.022039638771554992628479593897
```

```
ans =
25.010857580145688763213790992563
```

Now, consider the same function, but slightly increase the real part, $\zeta\left(\frac{1000000001}{2000000000} + iy\right)$. According to the Riemann hypothesis, this function does not have a zero for any real value y . If you use `vpasolve` with the 10 significant decimal digits, the solver finds the following (nonexisting) zero of the Zeta function:

```
old = digits;
digits(10)
vpasolve(zeta(1000000001/2000000000 + i*y), y, 15)
```

```
ans =
14.13472514
```



```
B = besselj(53/2, sym(pi));  
vpa(B, 10)
```

```
ans =  
-2854.225191
```

Plot this Bessel function for the values of x around $53/2$. The function plot shows that the approximation is incorrect:

```
syms x  
fplot(besselj(x, sym(pi)), [26 27])
```

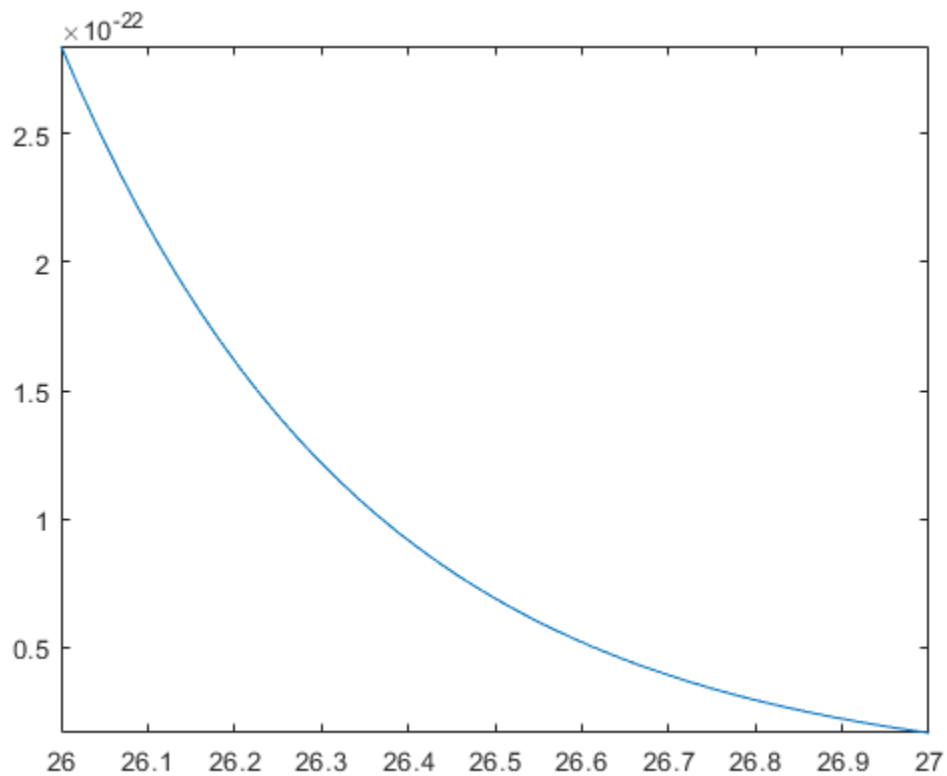

Increase Speed by Reducing Precision

Increase MATLAB's speed by reducing the precision of your calculations. Reduce precision by using variable-precision arithmetic provided by the `vpa` and `digits` functions in Symbolic Math Toolbox. When you reduce precision, you are gaining performance by reducing accuracy. For details, see "Choose Numeric or Symbolic Arithmetic" on page 2-124.

For example, finding the Riemann zeta function of the large matrix `C` takes a long time. First, initialize `C`.

```
[X,Y] = meshgrid((0:0.0025:.75),(5:-0.05:0));  
C = X + Y*i;
```

Then, find the time taken to calculate `zeta(C)`.

```
tic  
zeta(C);  
toc
```

Elapsed time is 340.204407 seconds.

Now, repeat this operation with a lower precision by using `vpa`. First, change the precision used by `vpa` to a lower precision of 10 digits by using `digits`. Then, use `vpa` to reduce the precision of `C` and find `zeta(C)` again. The operation is significantly faster.

```
digits(10)  
vpaC = vpa(C);  
tic  
zeta(vpaC);  
toc
```

Elapsed time is 113.792543 seconds.

Note `vpa` output is symbolic. To use symbolic output with a MATLAB function that does not accept symbolic values, convert symbolic values to double precision by using `double`.

For larger matrices, the difference in computation time can be even more significant. For example, consider the 1001-by-301 matrix `C`.

```
[X,Y] = meshgrid((0:0.0025:.75),(5:-0.005:0));  
C = X + Y*i;
```

Running `zeta(vpa(C))` with 10-digit precision takes 15 minutes, while running `zeta(C)` takes three times as long.

```
digits(10)  
vpaC = vpa(C);  
tic  
zeta(vpaC);  
toc
```

Elapsed time is 886.035806 seconds.

```
tic  
zeta(C);  
toc
```

Elapsed time is 2441.991572 seconds.

Note If you want to *increase* precision, see “Increase Precision of Numeric Calculations” on page 2-128.

Numeric to Symbolic Conversion

This topic shows how Symbolic Math Toolbox converts numbers into symbolic form. For an overview of symbolic and numeric arithmetic, see “Choose Numeric or Symbolic Arithmetic” on page 2-124.

To convert numeric input to symbolic form, use the `sym` command. By default, `sym` returns a rational approximation of a numeric expression.

```
t = 0.1;
sym(t)
```

```
ans =
1/10
```

`sym` determines that the double-precision value 0.1 approximates the exact symbolic value $1/10$. In general, `sym` tries to correct the round-off error in floating-point inputs to return the exact symbolic form. Specifically, `sym` corrects round-off error in numeric inputs that match the forms p/q , $p\pi/q$, $(p/q)^{1/2}$, 2^q , and 10^q , where p and q are modest-sized integers.

For these forms, demonstrate that `sym` converts floating-point inputs to the exact symbolic form. First, numerically approximate $1/7$, π , and $1/\sqrt{2}$.

```
N1 = 1/7
N2 = pi
N3 = 1/sqrt(2)
```

```
N1 =
0.1429
N2 =
3.1416
N3 =
0.7071
```

Convert the numeric approximations to exact symbolic form. `sym` corrects the round-off error.

```
S1 = sym(N1)
S2 = sym(N2)
S3 = sym(N3)
```

```
S1 =
1/7
S2 =
pi
S3 =
2^(1/2)/2
```

To return the error between the input and the estimated exact form, use the syntax `sym(num, 'e')`. See “Conversion to Rational Symbolic Form with Error Term” on page 2-137.

You can force `sym` to accept the input as is by placing the input in quotes. Demonstrate this behavior on the previous input 0.142857142857143. The `sym` function does not convert the input to $1/7$.

```
sym('0.142857142857143')
```

```
ans =
0.142857142857143
```

When you convert large numbers, use quotes to exactly represent them. Demonstrate this behavior by comparing `sym(13333333333333333333)` with `sym('13333333333333333333')`.

```
sym(13333333333333333333)
sym('13333333333333333333')
```

```
ans =
13333333333333333333248
ans =
13333333333333333333
```

You can specify the technique used by `sym` to convert floating-point numbers using the optional second argument, which can be 'f', 'r', 'e', or 'd'. The default flag is 'r', for rational form on page 2-137.

In this section...

“Conversion to Rational Symbolic Form” on page 2-137

“Conversion by Using Floating-Point Expansion” on page 2-137

“Conversion to Rational Symbolic Form with Error Term” on page 2-137

“Conversion to Decimal Form” on page 2-138

Conversion to Rational Symbolic Form

Convert input to exact rational form by calling `sym` with the 'r' flag. This is the default behavior when you call `sym` without flags.

```
sym(t, 'r')
```

```
ans =
1/10
```

Conversion by Using Floating-Point Expansion

If you call `sym` with the flag 'f', `sym` converts double-precision, floating-point numbers to their numeric value by using $N \cdot 2^e$, where N and e are the exponent and mantissa respectively.

Convert `t` by using a floating-point expansion.

```
sym(t, 'f')
```

```
ans =
3602879701896397/36028797018963968
```

Conversion to Rational Symbolic Form with Error Term

If you call `sym` with the flag 'e', `sym` returns the rational form of `t` plus the error between the estimated, exact value for `t` and its floating-point representation. This error is expressed in terms of `eps` (the floating-point relative precision).

Convert `t` to symbolic form. Return the error between its estimated symbolic form and its floating-point value.

```
sym(t, 'e')
```

```
ans =  
eps/40 + 1/10
```

The error term $\text{eps}/40$ is the difference between $\text{sym}('0.1')$ and $\text{sym}(0.1)$.

Conversion to Decimal Form

If you call `sym` with the flag 'd', `sym` returns the decimal expansion of the input. The `digits` function specifies the number of significant digits used. The default value of `digits` is 32.

```
sym(t, 'd')
```

```
ans =  
0.100000000000000000555111512312578
```

Change the number of significant digits by using `digits`.

```
digitsOld = digits(7);  
sym(t, 'd')
```

```
ans =  
0.1
```

For further calculations, restore the old value of `digits`.

```
digits(digitsOld)
```

Basic Algebraic Operations

Basic algebraic operations on symbolic objects are the same as operations on MATLAB objects of class `double`. This is illustrated in the following example.

The Givens transformation produces a plane rotation through the angle t . The statements

```
syms t
G = [cos(t) sin(t); -sin(t) cos(t)]
```

create this transformation matrix.

```
G =
[ cos(t),  sin(t)]
[ -sin(t),  cos(t)]
```

Applying the Givens transformation twice should simply be a rotation through twice the angle. The corresponding matrix can be computed by multiplying G by itself or by raising G to the second power. Both

```
A = G*G
```

and

```
A = G^2
```

produce

```
A =
[ cos(t)^2 - sin(t)^2,    2*cos(t)*sin(t)]
[ -2*cos(t)*sin(t), cos(t)^2 - sin(t)^2]
```

The `simplify` function

```
A = simplify(A)
```

uses a trigonometric identity to return the expected form by trying several different identities and picking the one that produces the shortest representation.

```
A =
[ cos(2*t),  sin(2*t)]
[ -sin(2*t),  cos(2*t)]
```

The Givens rotation is an orthogonal matrix, so its transpose is its inverse. Confirming this by

```
I = G.' *G
```

which produces

```
I =
[ cos(t)^2 + sin(t)^2,    0]
[ 0, cos(t)^2 + sin(t)^2]
```

and then

```
I = simplify(I)
```

$$I = \begin{bmatrix} 1, & 0 \\ 0, & 1 \end{bmatrix}$$

Linear Algebraic Operations

In this section...

"Symbolic Hilbert Matrix" on page 2-141
 "Symbolic Linear Algebra Operations" on page 2-141
 "Variable-Precision Arithmetic" on page 2-142
 "Symbolic Investigation of Singular Value" on page 2-143

Symbolic Hilbert Matrix

The following examples, which show how to perform basic linear algebraic operations, are based on a symbolic version of the 3-by-3 Hilbert matrix.

Generate the 3-by-3 Hilbert matrix. With `format short`, MATLAB prints the output shown.

```
H = hilb(3)
H =
    1.0000    0.5000    0.3333
    0.5000    0.3333    0.2500
    0.3333    0.2500    0.2000
```

The computed elements of `H` are floating-point numbers that are the ratios of small integers. `H` is a MATLAB array of class `double`.

Convert `H` to a symbolic matrix.

```
H = sym(H)
H =
[ 1, 1/2, 1/3]
[ 1/2, 1/3, 1/4]
[ 1/3, 1/4, 1/5]
```

Symbolic Linear Algebra Operations

Symbolic operations on `H` produce results that correspond to the infinite-precision Hilbert matrix, `sym(hilb(3))`, not its floating-point approximation, `hilb(3)`.

Find the inverse of `H`.

```
inv(H)
ans =
[ 9, -36, 30]
[ -36, 192, -180]
[ 30, -180, 180]
```

Find the determinant of `H`.

```
det(H)
ans =
1/2160
```

You can use the backslash operator to solve a system of simultaneous linear equations. For example, solve $H*x = b$.

```
b = [1; 1; 1];
x = H\b
```

```
x =
     3
    -24
     30
```

All three results—the inverse, the determinant, and the solution to the linear system—are the exact results corresponding to the infinite-precision, rational, Hilbert matrix.

Variable-Precision Arithmetic

Contrast the preceding operations with variable-precision arithmetic using 20 digits of precision.

```
digits(20)
V = vpa(H)
```

```
V =
```

```
[          1.0,          0.5, 0.33333333333333333333]
[          0.5, 0.33333333333333333333,          0.25]
[ 0.33333333333333333333,          0.25,          0.2]
```

The decimal points in the representation of the individual elements indicate that MATLAB is using variable-precision arithmetic. The result of each arithmetic operation is rounded to 20 significant decimal digits.

Invert the matrix and note that errors are magnified by the matrix condition number, which for `hilb(3)` is about 500.

```
cond(V)
```

```
ans =
```

```
524.0567775860608
```

Compute the difference of the inverses of the infinite-precision and variable-precision versions.

```
ih = inv(H)
```

```
ih =
```

```
[  9, -36,  30]
[-36, 192, -180]
[ 30, -180, 180]
```

```
iv = inv(V)
```

```
iv =
```

```
[  9.0, -36.0,  30.0]
[-36.0, 192.0, -180.0]
[ 30.0, -180.0, 180.0]
```

Although these matrices look the same, calculate the difference to see that they are not.

```
dhv = ih - iv
```

```
dhv =
```

```
[ -5.4929962552349494034e-26,  2.4556924435168009098e-25, -2.1971985020939797614e-25]
[  2.4556924435168009098e-25, -1.2666203129718236271e-24,  1.1373733422604130529e-24]
[ -2.1971985020939797614e-25,  1.1373733422604130529e-24, -1.0856745539758488233e-24]
```

Solve the equation $V*y = b$. The answer looks the same as the solution to $H*x = b$.

```
y = V\b
```

```
y =
```

```
    3.0
   -24.0
   30.0
```

Calculate the difference between x and y to see the small difference between the two solutions.

```
x-y
```

```
ans =
```

```
 8.0779356694631608874e-27
 -6.4623485355705287099e-26
 7.1085833891275815809e-26
```

Using `vpa` with `digits(16)` offers comparable precision to using standard double-precision MATLAB routines.

Symbolic Investigation of Singular Value

Find a value s for $H(1,1)$ that makes H singular.

```
syms s
Hs = H;
Hs(1,1) = s
Z = det(Hs)
sol = solve(Z)
```

```
Hs =
[  s, 1/2, 1/3]
[ 1/2, 1/3, 1/4]
[ 1/3, 1/4, 1/5]
```

```
Z =
s/240 - 1/270
```

```
sol =
8/9
```

Substitute the solution for s into Hs .

```
Hs = subs(Hs, s, sol)
```

```
Hs =  
[ 8/9, 1/2, 1/3]  
[ 1/2, 1/3, 1/4]  
[ 1/3, 1/4, 1/5]
```

Verify that the determinant of Hs is zero.

```
det(Hs)
```

```
ans =  
0
```

Find the null space and column space of Hs. Both spaces are nontrivial.

```
N = null(Hs)  
C = colspace(Hs)
```

```
N=  
3/10  
-6/5  
1
```

```
C =  
[ 1, 0]  
[ 0, 1]  
[ -3/10, 6/5]
```

Check that N is in the null space of Hs.

```
Hs*N
```

```
ans =  
  
0  
0  
0
```

Eigenvalues

The symbolic eigenvalues of a square matrix A or the symbolic eigenvalues and eigenvectors of A are computed, respectively, using the commands $E = \text{eig}(A)$ and $[V,E] = \text{eig}(A)$.

The variable-precision counterparts are $E = \text{eig}(vpa(A))$ and $[V,E] = \text{eig}(vpa(A))$.

The eigenvalues of A are the zeros of the characteristic polynomial of A , $\det(A - xI)$, which is computed by $\text{charpoly}(A)$.

The matrix H from the last section provides the first example:

```
H = sym([8/9 1/2 1/3; 1/2 1/3 1/4; 1/3 1/4 1/5])
```

```
H =
[ 8/9, 1/2, 1/3]
[ 1/2, 1/3, 1/4]
[ 1/3, 1/4, 1/5]
```

The matrix is singular, so one of its eigenvalues must be zero. The statement

```
[T,E] = eig(H)
```

produces the matrices T and E . The columns of T are the eigenvectors of H and the diagonal elements of E are the eigenvalues of H :

```
T =
[ 3/10, 218/285 - (4*12589^(1/2))/285, (4*12589^(1/2))/285 + 218/285]
[ -6/5, 292/285 - 12589^(1/2)/285, 12589^(1/2)/285 + 292/285]
[ 1, 1, 1]

E =
[ 0, 0, 0]
[ 0, 32/45 - 12589^(1/2)/180, 0]
[ 0, 0, 12589^(1/2)/180 + 32/45]
```

It may be easier to understand the structure of the matrices of eigenvectors, T , and eigenvalues, E , if you convert T and E to decimal notation. To do so, proceed as follows. The commands

```
Td = double(T)
Ed = double(E)
```

```
return
```

```
Td =
  0.3000   -0.8098   2.3397
 -1.2000   0.6309   1.4182
  1.0000   1.0000   1.0000

Ed =
  0         0         0
  0   0.0878   0
  0         0   1.3344
```

The first eigenvalue is zero. The corresponding eigenvector (the first column of Td) is the same as the basis for the null space found in the last section. The other two eigenvalues are the result of applying the quadratic formula to $x^2 - \frac{64}{45}x + \frac{253}{2160}$ which is the quadratic factor in $\text{factor}(\text{charpoly}(H, x))$:

```

syms x
g = factor(charpoly(H, x))/x
solve(g(3))

g =
[ 1/(2160*x), 1, (2160*x^2 - 3072*x + 253)/x]
ans =
32/45 - 12589^(1/2)/180
12589^(1/2)/180 + 32/45

```

Closed form symbolic expressions for the eigenvalues are possible only when the characteristic polynomial can be expressed as a product of rational polynomials of degree four or less. The Rosser matrix is a classic numerical analysis test matrix that illustrates this requirement. The statement

```
R = sym(rosser)
```

generates

```

R =
[ 611, 196, -192, 407, -8, -52, -49, 29]
[ 196, 899, 113, -192, -71, -43, -8, -44]
[ -192, 113, 899, 196, 61, 49, 8, 52]
[ 407, -192, 196, 611, 8, 44, 59, -23]
[ -8, -71, 61, 8, 411, -599, 208, 208]
[ -52, -43, 49, 44, -599, 411, 208, 208]
[ -49, -8, 8, 59, 208, 208, 99, -911]
[ 29, -44, 52, -23, 208, 208, -911, 99]

```

The commands

```
p = charpoly(R, x);
factor(p)
```

produce

```

ans =
[ x, x - 1020, x^2 - 1040500, x^2 - 1020*x + 100, x - 1000, x - 1000]

```

The characteristic polynomial (of degree 8) factors nicely into the product of two linear terms and three quadratic terms. You can see immediately that four of the eigenvalues are 0, 1020, and a double root at 1000. The other four roots are obtained from the remaining quadratics. Use

```
eig(R)
```

to find all these values

```

ans =
0
1000
1000
1020
510 - 100*26^(1/2)
100*26^(1/2) + 510
-10*10405^(1/2)
10*10405^(1/2)

```

The Rosser matrix is not a typical example; it is rare for a full 8-by-8 matrix to have a characteristic polynomial that factors into such simple form. If you change the two “corner” elements of R from 29 to 30 with the commands

```
S = R;
S(1,8) = 30;
S(8,1) = 30;
```

and then try

```
p = charpoly(S, x)
```

you find

```
p =
x^8 - 4040*x^7 + 5079941*x^6 + 82706090*x^5...
- 5327831918568*x^4 + 4287832912719760*x^3...
- 1082699388411166000*x^2 + 51264008540948000*x...
+ 40250968213600000
```

You also find that `factor(p)` is `p` itself. That is, the characteristic polynomial cannot be factored over the rationals.

For this modified Rosser matrix

```
F = eig(S)
```

returns

```
F =
-1020.053214255892
-0.17053529728769
0.2180398054830161
999.9469178604428
1000.120698293384
1019.524355263202
1019.993550129163
1020.420188201505
```

Notice that these values are close to the eigenvalues of the original Rosser matrix.

It is also possible to try to compute eigenvalues of symbolic matrices, but closed form solutions are rare. The Givens transformation is generated as the matrix exponential of the elementary matrix

$$A = \begin{bmatrix} 0 & 1 \\ -1 & 0 \end{bmatrix}.$$

Symbolic Math Toolbox commands

```
syms t
A = sym([0 1; -1 0]);
G = expm(t*A)
```

return

```
G =
[      exp(-t*1i)/2 + exp(t*1i)/2,
  (exp(-t*1i)*1i)/2 - (exp(t*1i)*1i)/2]
[ - (exp(-t*1i)*1i)/2 + (exp(t*1i)*1i)/2,
      exp(-t*1i)/2 + exp(t*1i)/2]
```

You can simplify this expression using `simplify`:

```
G = simplify(G)
```

```
G =  
[ cos(t), sin(t)]  
[ -sin(t), cos(t)]
```

Next, the command

```
g = eig(G)
```

produces

```
g =  
cos(t) - sin(t)*1i  
cos(t) + sin(t)*1i
```

You can rewrite g in terms of exponents:

```
g = rewrite(g, 'exp')
```

```
g =  
exp(-t*1i)  
exp(t*1i)
```

Jordan Canonical Form

The Jordan canonical form (Jordan normal form) results from attempts to convert a matrix to its diagonal form by a similarity transformation. For a given matrix A , find a nonsingular matrix V , so that $\text{inv}(V)*A*V$, or, more succinctly, $J = V\backslash A*V$, is "as close to diagonal as possible." For almost all matrices, the Jordan canonical form is the diagonal matrix of eigenvalues and the columns of the transformation matrix are the eigenvectors. This always happens if the matrix is symmetric or if it has distinct eigenvalues. Some nonsymmetric matrices with multiple eigenvalues cannot be converted to diagonal forms. The Jordan form has the eigenvalues on its diagonal, but some of the superdiagonal elements are one, instead of zero. The statement

```
J = jordan(A)
```

computes the Jordan canonical form of A . The statement

```
[V,J] = jordan(A)
```

also computes the similarity transformation where $J = \text{inv}(V)*A*V$. The columns of V are the generalized eigenvectors of A .

The Jordan form is extremely sensitive to changes. Almost any change in A causes its Jordan form to be diagonal. This implies that A must be known exactly (i.e., without round-off error, etc.) and makes it very difficult to compute the Jordan form reliably with floating-point arithmetic. Thus, computing the Jordan form with floating-point values is unreliable and not recommended.

For example, let

```
A = sym([12,32,66,116;-25,-76,-164,-294;
        21,66,143,256;-6,-19,-41,-73])
```

```
A =
[ 12, 32, 66, 116]
[ -25, -76, -164, -294]
[ 21, 66, 143, 256]
[ -6, -19, -41, -73]
```

Then

```
[V,J] = jordan(A)
```

produces

```
V =
[ 4, -2, 4, 3]
[ -6, 8, -11, -8]
[ 4, -7, 10, 7]
[ -1, 2, -3, -2]
```

```
J =
[ 1, 1, 0, 0]
[ 0, 1, 0, 0]
[ 0, 0, 2, 1]
[ 0, 0, 0, 2]
```

Show that J and $\text{inv}(V)*A*V$ are equal by using `isequal`. The `isequal` function returns logical 1 (`true`) meaning that the inputs are equal.

```
isequal(J, inv(V)*A*V)
```

```
ans =  
    logical  
     1
```

From J , we see that A has a double eigenvalue at 1, with a single Jordan block, and a double eigenvalue at 2, also with a single Jordan block. The matrix has only two eigenvectors, $V(:, 1)$ and $V(:, 3)$. They satisfy

$$\begin{aligned}A*V(:, 1) &= 1*V(:, 1) \\ A*V(:, 3) &= 2*V(:, 3)\end{aligned}$$

The other two columns of V are generalized eigenvectors of grade 2. They satisfy

$$\begin{aligned}A*V(:, 2) &= 1*V(:, 2) + V(:, 1) \\ A*V(:, 4) &= 2*V(:, 4) + V(:, 3)\end{aligned}$$

In mathematical notation, with $v_j = v(:, j)$, the columns of V and eigenvalues satisfy the relationships

$$(A - \lambda_1 I)v_2 = v_1$$

$$(A - \lambda_2 I)v_4 = v_3.$$

Singular Value Decomposition

Singular value decomposition expresses an m -by- n matrix A as $A = U*S*V'$. Here, S is an m -by- n diagonal matrix with singular values of A on its diagonal. The columns of the m -by- m matrix U are the left singular vectors for corresponding singular values. The columns of the n -by- n matrix V are the right singular vectors for corresponding singular values. V' is the Hermitian transpose (the complex conjugate of the transpose) of V .

To compute the singular value decomposition of a matrix, use `svd`. This function lets you compute singular values of a matrix separately or both singular values and singular vectors in one function call. To compute singular values only, use `svd` without output arguments

```
svd(A)
```

or with one output argument

```
S = svd(A)
```

To compute singular values and singular vectors of a matrix, use three output arguments:

```
[U,S,V] = svd(A)
```

`svd` returns two unitary matrices, U and V , the columns of which are singular vectors. It also returns a diagonal matrix, S , containing singular values on its diagonal. The elements of all three matrices are floating-point numbers. The accuracy of computations is determined by the current setting of `digits`.

Create the n -by- n matrix A with elements defined by $A(i,j) = 1/(i - j + 1/2)$. The most obvious way of generating this matrix is

```
n = 3;
for i = 1:n
    for j = 1:n
        A(i,j) = sym(1/(i-j+1/2));
    end
end
```

For $n = 3$, the matrix is

A

```
A =
[ 2, -2, -2/3]
[ 2/3, 2, -2]
[ 2/5, 2/3, 2]
```

Compute the singular values of this matrix. If you use `svd` directly, it will return exact symbolic result. For this matrix, the result is very long. If you prefer a shorter numeric result, convert the elements of A to floating-point numbers using `vpa`. Then use `svd` to compute singular values of this matrix using variable-precision arithmetic:

```
S = svd(vpa(A))
```

```
S =
3.1387302525015353960741348953506
3.0107425975027462353291981598225
1.6053456783345441725883965978052
```

Now, compute the singular values and singular vectors of A:

$[U,S,V] = \text{svd}(A)$

```

U =
[ 0.53254331027335338470683368360204, 0.76576895948802052989304092179952, ...
  0.36054891952096214791189887728353]
[ -0.82525689650849463222502853672224, 0.37514965283965451993171338605042, ...
  0.42215375485651489522488031917364]
[ 0.18801243961043281839917114171742, -0.52236064041897439447429784257224, ...
  0.83173955292075192178421874331406]

S =
[ 3.1387302525015353960741348953506, 0, ...
  0]
[ 0, 3.0107425975027462353291981598225, ...
  0]
[ 0, 0, ...
  1.6053456783345441725883965978052]

V =
[ 0.18801243961043281839917114171742, 0.52236064041897439447429784257224, ...
  0.83173955292075192178421874331406]
[ -0.82525689650849463222502853672224, -0.37514965283965451993171338605042, ...
  0.42215375485651489522488031917364]
[ 0.53254331027335338470683368360204, -0.76576895948802052989304092179952, ...
  0.36054891952096214791189887728353]
    
```

Solve Algebraic Equation

Symbolic Math Toolbox offers both symbolic and numeric equation solvers. This topic shows you how to solve an equation symbolically using the symbolic solver `solve`. To compare symbolic and numeric solvers, see “Select Numeric or Symbolic Solver” on page 2-159.

In this section...

“Solve an Equation” on page 2-153

“Return the Full Solution to an Equation” on page 2-153

“Work with the Full Solution, Parameters, and Conditions Returned by `solve`” on page 2-154

“Visualize and Plot Solutions Returned by `solve`” on page 2-155

“Simplify Complicated Results and Improve Performance” on page 2-156

Solve an Equation

If `eqn` is an equation, `solve(eqn, x)` solves `eqn` for the symbolic variable `x`.

Use the `==` operator to specify the familiar quadratic equation and solve it using `solve`.

```
syms a b c x
eqn = a*x^2 + b*x + c == 0;
solx = solve(eqn, x)

solx =
  -(b + (b^2 - 4*a*c)^(1/2))/(2*a)
  -(b - (b^2 - 4*a*c)^(1/2))/(2*a)
```

`solx` is a symbolic vector containing the two solutions of the quadratic equation. If the input `eqn` is an expression and not an equation, `solve` solves the equation `eqn == 0`.

To solve for a variable other than `x`, specify that variable instead. For example, solve `eqn` for `b`.

```
solb = solve(eqn, b)

solb =
  -(a*x^2 + c)/x
```

If you do not specify a variable, `solve` uses `symvar` to select the variable to solve for. For example, `solve(eqn)` solves `eqn` for `x`.

Return the Full Solution to an Equation

`solve` does not automatically return all solutions of an equation. Solve the equation `cos(x) == -sin(x)`. The `solve` function returns one of many solutions.

```
syms x
solx = solve(cos(x) == -sin(x), x)

solx =
  -pi/4
```

To return all solutions along with the parameters in the solution and the conditions on the solution, set the `ReturnConditions` option to `true`. Solve the same equation for the full solution. Provide

three output variables: for the solution to x , for the parameters in the solution, and for the conditions on the solution.

```
syms x
[solx, param, cond] = solve(cos(x) == -sin(x), x, 'ReturnConditions', true)

solx =
pi*k - pi/4
param =
k
cond =
in(k, 'integer')
```

`solx` contains the solution for x , which is $\pi k - \pi/4$. The `param` variable specifies the parameter in the solution, which is k . The `cond` variable specifies the condition `in(k, 'integer')` on the solution, which means k must be an integer. Thus, `solve` returns a periodic solution starting at $\pi/4$ which repeats at intervals of πk , where k is an integer.

Work with the Full Solution, Parameters, and Conditions Returned by solve

You can use the solutions, parameters, and conditions returned by `solve` to find solutions within an interval or under additional conditions.

To find values of x in the interval $-2\pi < x < 2\pi$, solve `solx` for k within that interval under the condition `cond`. Assume the condition `cond` using `assume`.

```
assume(cond)
solk = solve(-2*pi < solx, solx < 2*pi, param)

solk =
-1
0
1
2
```

To find values of x corresponding to these values of k , use `subs` to substitute for k in `solx`.

```
xvalues = subs(solx, solk)

xvalues =
-(5*pi)/4
-pi/4
(3*pi)/4
(7*pi)/4
```

To convert these symbolic values into numeric values for use in numeric calculations, use `vpa`.

```
xvalues = vpa(xvalues)

xvalues =
-3.9269908169872415480783042290994
-0.78539816339744830961566084581988
2.3561944901923449288469825374596
5.4977871437821381673096259207391
```

Visualize and Plot Solutions Returned by solve

The previous sections used `solve` to solve the equation $\cos(x) == -\sin(x)$. The solution to this equation can be visualized using plotting functions such as `fplot` and `scatter`.

Plot both sides of equation $\cos(x) == -\sin(x)$.

```
fplot(cos(x))
hold on
grid on
fplot(-sin(x))
title('Both sides of equation cos(x) = -sin(x)')
legend('cos(x)', '-sin(x)', 'Location', 'best', 'AutoUpdate', 'off')
```

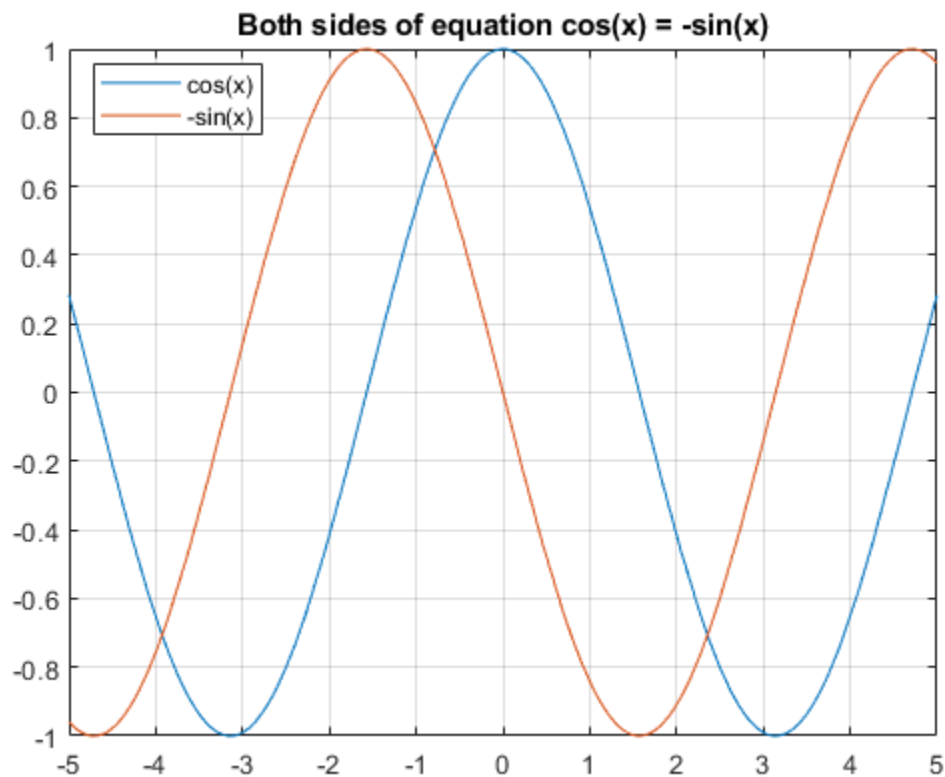

Calculate the values of the functions at the values of x , and superimpose the solutions as points using `scatter`.

```
yvalues = cos(xvalues)
```

```
yvalues =
    (-0.70710678118654752440084436210485)
    ( 0.70710678118654752440084436210485)
    (-0.70710678118654752440084436210485)
    ( 0.70710678118654752440084436210485)
```

```
scatter(xvalues, yvalues)
```

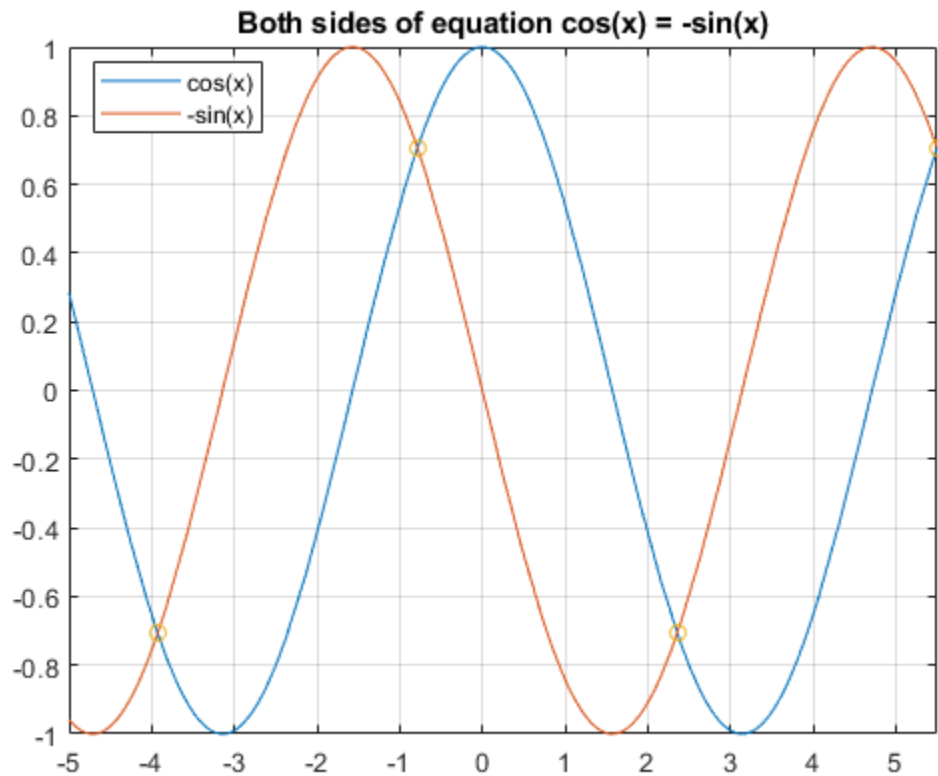

As expected, the solutions appear at the intersection of the two plots.

Simplify Complicated Results and Improve Performance

If results look complicated, `solve` is stuck, or if you want to improve performance, see, “Troubleshoot Equation Solutions from `solve` Function” on page 2-169.

Solve a Second-Order Differential Equation Numerically

This example shows you how to convert a second-order differential equation into a system of differential equations that can be solved using the numerical solver `ode45` of MATLAB®.

A typical approach to solving higher-order ordinary differential equations is to convert them to systems of first-order differential equations, and then solve those systems. The example uses Symbolic Math Toolbox™ to convert a second-order ODE to a system of first-order ODEs. Then it uses the MATLAB solver `ode45` to solve the system.

Rewrite the Second-Order ODE as a System of First-Order ODEs

Use `odeToVectorField` to rewrite this second-order differential equation

$$\frac{d^2y}{dt^2} = (1 - y^2)\frac{dy}{dt} - y$$

using a change of variables. Let $y(t) = Y_1$ and $\frac{dy}{dt} = Y_2$ such that differentiating both equations we obtain a system of first-order differential equations.

$$\begin{aligned}\frac{dY_1}{dt} &= Y_2 \\ \frac{dY_2}{dt} &= -(Y_1^2 - 1)Y_2 - Y_1\end{aligned}$$

```
syms y(t)
[V] = odeToVectorField(diff(y, 2) == (1 - y^2)*diff(y) - y)
```

$$V = \begin{pmatrix} Y_2 \\ -(Y_1^2 - 1)Y_2 - Y_1 \end{pmatrix}$$

Generate MATLAB function

The MATLAB ODE solvers do not accept symbolic expressions as an input. Therefore, before you can use a MATLAB ODE solver to solve the system, you must convert that system to a MATLAB function. Generate a MATLAB function from this system of first-order differential equations using `matlabFunction` with `V` as an input.

```
M = matlabFunction(V, 'vars', {'t', 'Y'})

M = function_handle with value:
@(t,Y)[Y(2); -(Y(1).^2-1.0).*Y(2)-Y(1)]
```

Solve the System of First-Order ODEs

To solve this system, call the MATLAB `ode45` numerical solver using the generated MATLAB function as an input.

```
sol = ode45(M, [0 20], [2 0]);
```

Plot the Solution

Plot the solution using `linspace` to generate 100 points in the interval `[0,20]` and `deval` to evaluate the solution for each point.

```
fplot(@(x)deval(sol,x,1), [0, 20])
```

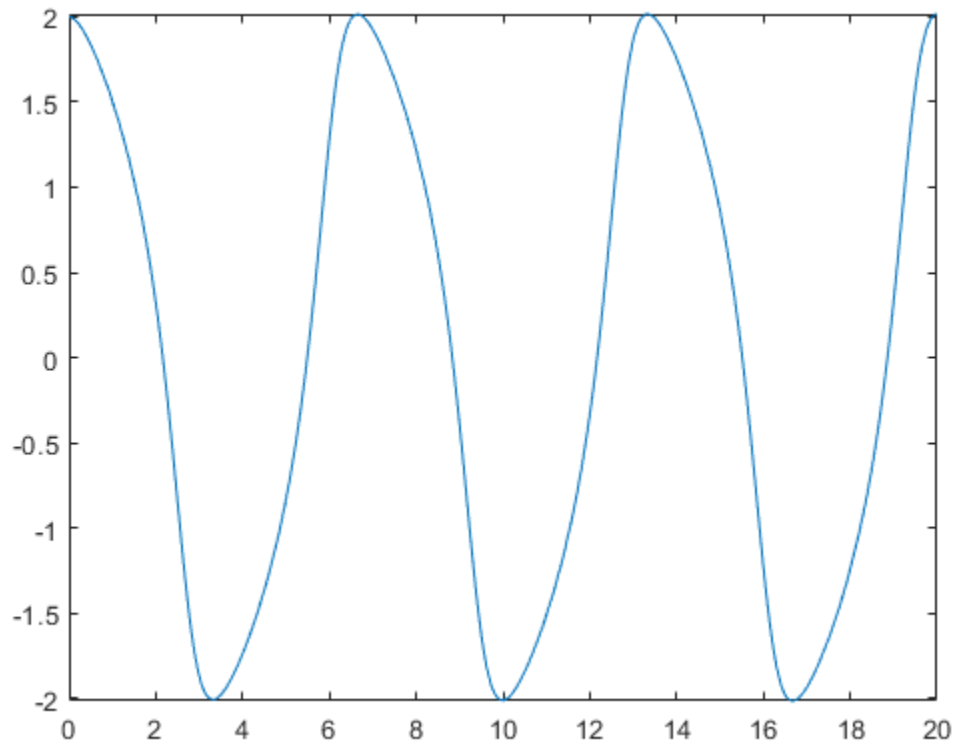
**See Also**

[dsolve](#) | [matlabFunction](#) | [ode45](#) | [odeToVectorField](#)

Select Numeric or Symbolic Solver

You can solve equations to obtain a symbolic or numeric answer. For example, a solution to $\cos(x) = -1$ is π in symbolic form and 3.14159 in numeric form. The symbolic solution is exact, while the numeric solution approximates the exact symbolic solution. Symbolic Math Toolbox offers both symbolic and numeric equation solvers. This table can help you choose either the symbolic solver (`solve`) or the numeric solver (`vpasolve`). A possible strategy is to try the symbolic solver first, and use the numeric solver if the symbolic solver is stuck.

Solve Equations Symbolically Using <code>solve</code>	Solve Equations Numerically Using <code>vpasolve</code>
Returns exact solutions. Solutions can then be approximated using <code>vpa</code> .	Returns approximate solutions. Precision can be controlled arbitrarily using <code>digits</code> .
Returns a general form of the solution.	For polynomial equations, returns all numeric solutions that exist. For nonpolynomial equations, returns the first numeric solution found.
General form allows insight into the solution.	Numeric solutions provide less insight.
Runs slower.	Runs faster.
Search ranges can be specified using inequalities.	Search ranges and starting points can be specified.
<code>solve</code> solves equations and inequalities that contain parameters.	<code>vpasolve</code> does not solve inequalities, nor does it solve equations that contain parameters.
<code>solve</code> can return parameterized solutions.	<code>vpasolve</code> does not return parameterized solutions.

`vpasolve` uses variable-precision arithmetic. You can control precision arbitrarily using `digits`. For examples, see “Increase Precision of Numeric Calculations” on page 2-128.

See Also

`solve` | `vpasolve`

Related Examples

- “Solve Algebraic Equation” on page 2-153
- “Solve Equations Numerically” on page 2-176
- “Solve System of Linear Equations” on page 2-173

Solve System of Algebraic Equations

This topic shows you how to solve a system of equations symbolically using Symbolic Math Toolbox. This toolbox offers both numeric and symbolic equation solvers. For a comparison of numeric and symbolic solvers, see “Select Numeric or Symbolic Solver” on page 2-159.

In this section...

“Handle the Output of solve” on page 2-160

“Solve a Linear System of Equations” on page 2-162

“Return the Full Solution of a System of Equations” on page 2-162

“Solve a System of Equations Under Conditions” on page 2-164

“Work with Solutions, Parameters, and Conditions Returned by solve” on page 2-165

“Convert Symbolic Results to Numeric Values” on page 2-167

“Simplify Complicated Results and Improve Performance” on page 2-168

Handle the Output of solve

Suppose you have the system

$$\begin{aligned}x^2y^2 &= 0 \\ x - \frac{y}{2} &= a,\end{aligned}$$

and you want to solve for x and y . First, create the necessary symbolic objects.

```
syms x y a
```

There are several ways to address the output of `solve`. One way is to use a two-output call.

```
[solx,soly] = solve(x^2*y^2 == 0, x-y/2 == a)
```

The call returns the following.

```
solx =
  0
  a
soly =
 -2*a
  0
```

Modify the first equation to $x^2y^2 = 1$. The new system has more solutions.

```
[solx,soly] = solve(x^2*y^2 == 1, x-y/2 == a)
```

Four distinct solutions are produced.

```
solx =
 a/2 - (a^2 - 2)^(1/2)/2
 a/2 - (a^2 + 2)^(1/2)/2
 a/2 + (a^2 - 2)^(1/2)/2
 a/2 + (a^2 + 2)^(1/2)/2
soly =
```

```
- a - (a^2 - 2)^(1/2)
- a - (a^2 + 2)^(1/2)
(a^2 - 2)^(1/2) - a
(a^2 + 2)^(1/2) - a
```

Since you did not specify the dependent variables, `solve` uses `symvar` to determine the variables.

This way of assigning output from `solve` is quite successful for “small” systems. For instance, if you have a 10-by-10 system of equations, typing the following is both awkward and time consuming.

```
[x1,x2,x3,x4,x5,x6,x7,x8,x9,x10] = solve(...)
```

To circumvent this difficulty, `solve` can return a structure whose fields are the solutions. For example, solve the system of equations $u^2 - v^2 = a^2$, $u + v = 1$, $a^2 - 2a = 3$.

```
syms u v a
S = solve(u^2 - v^2 == a^2, u + v == 1, a^2 - 2*a == 3)
```

The solver returns its results enclosed in this structure.

```
S =
  struct with fields:

    a: [2×1 sym]
    u: [2×1 sym]
    v: [2×1 sym]
```

The solutions for `a` reside in the “`a`-field” of `S`.

```
S.a
```

```
ans =
  -1
   3
```

Similar comments apply to the solutions for `u` and `v`. The structure `S` can now be manipulated by the field and index to access a particular portion of the solution. For example, to examine the second solution, you can use the following statement to extract the second component of each field.

```
s2 = [S.a(2), S.u(2), S.v(2)]
```

```
s2 =
[ 3, 5, -4]
```

The following statement creates the solution matrix `M` whose rows comprise the distinct solutions of the system.

```
M = [S.a, S.u, S.v]
```

```
M =
[ -1, 1, 0]
[ 3, 5, -4]
```

Clear `solx` and `soly` for further use.

```
clear solx soly
```

Solve a Linear System of Equations

Linear systems of equations can also be solved using matrix division. For example, solve this system.

```
clear u v x y
syms u v x y
eqns = [x + 2*y == u, 4*x + 5*y == v];
S = solve(eqns);
sol = [S.x; S.y]
```

```
[A,b] = equationsToMatrix(eqns,x,y);
z = A\b
```

```
sol =
(2*v)/3 - (5*u)/3
(4*u)/3 - v/3
```

```
z =
(2*v)/3 - (5*u)/3
(4*u)/3 - v/3
```

Thus, `sol` and `z` produce the same solution, although the results are assigned to different variables.

Return the Full Solution of a System of Equations

`solve` does not automatically return all solutions of an equation. To return all solutions along with the parameters in the solution and the conditions on the solution, set the `ReturnConditions` option to `true`.

Consider the following system of equations:

$$\sin(x) + \cos(y) = \frac{4}{5}$$

$$\sin(x)\cos(y) = \frac{1}{10}$$

Visualize the system of equations using `fimplicit`. To set the x -axis and y -axis values in terms of π , get the axes handles using `axes` in `a`. Create the symbolic array `S` of the values -2π to 2π at intervals of $\pi/2$. To set the ticks to `S`, use the `XTick` and `YTick` properties of `a`. To set the labels for the x - and y -axes, convert `S` to character vectors. Use `arrayfun` to apply `char` to every element of `S` to return `T`. Set the `XTickLabel` and `YTickLabel` properties of `a` to `T`.

```
syms x y
eqn1 = sin(x)+cos(y) == 4/5;
eqn2 = sin(x)*cos(y) == 1/10;
a = axes;
fimplicit(eqn1,[-2*pi 2*pi],'b');
hold on
grid on
fimplicit(eqn2,[-2*pi 2*pi],'m');
L = sym(-2*pi:pi/2:2*pi);
a.XTick = double(L);
a.YTick = double(L);
M = arrayfun(@char, L, 'UniformOutput', false);
a.XTickLabel = M;
a.YTickLabel = M;
```

```

title('Plot of System of Equations')
legend('sin(x)+cos(y) == 4/5','sin(x)*cos(y) == 1/10',...
'Location','best','AutoUpdate','off')

```

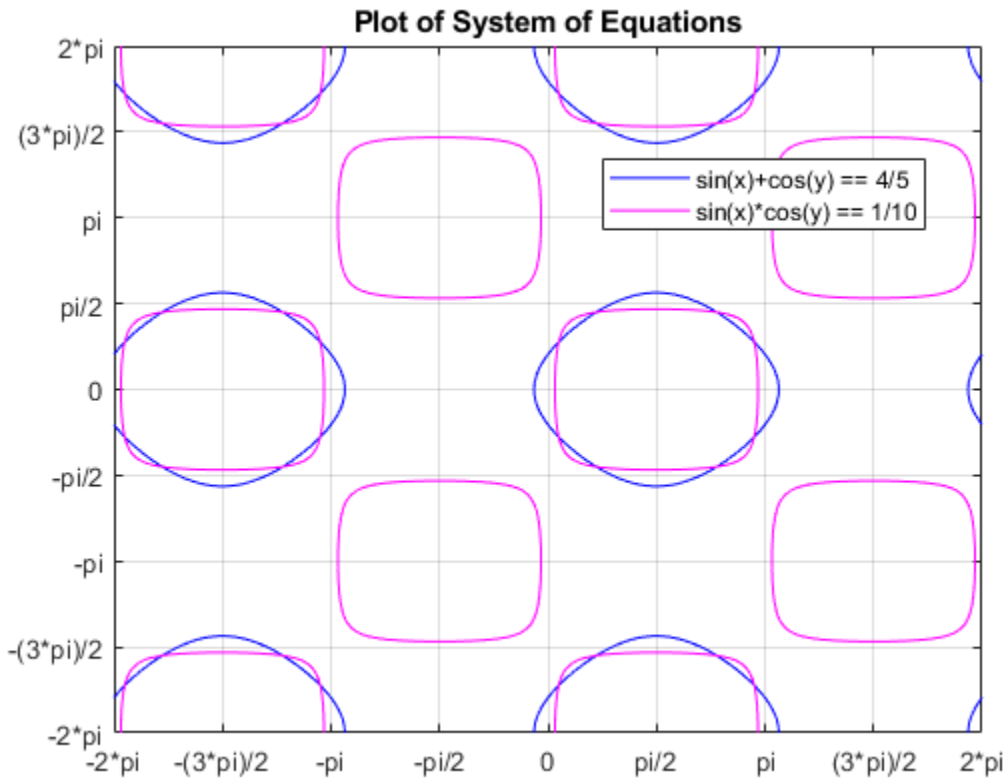

The solutions lie at the intersection of the two plots. This shows the system has repeated, periodic solutions. To solve this system of equations for the full solution set, use `solve` and set the `ReturnConditions` option to `true`.

```
S = solve(eq1, eq2, 'ReturnConditions', true)
```

```

S =
  struct with fields:
      x: [2×1 sym]
      y: [2×1 sym]
  parameters: [1×2 sym]
  conditions: [2×1 sym]

```

`solve` returns a structure `S` with the fields `S.x` for the solution to `x`, `S.y` for the solution to `y`, `S.parameters` for the parameters in the solution, and `S.conditions` for the conditions on the solution. Elements of the same index in `S.x`, `S.y`, and `S.conditions` form a solution. Thus, `S.x(1)`, `S.y(1)`, and `S.conditions(1)` form one solution to the system of equations. The parameters in `S.parameters` can appear in all solutions.

Index into `S` to return the solutions, parameters, and conditions.

```

S.x
S.y

```

```
S.parameters  
S.conditions
```

```
ans =  
  z1  
  z1  
ans =  
  z  
  z  
ans =  
[ z, z1]  
ans =  
(in((z - acos(6^(1/2)/10 + 2/5))/(2*pi), 'integer') |...  
 in((z + acos(6^(1/2)/10 + 2/5))/(2*pi), 'integer')) &...  
(in(-(pi - z1 + asin(6^(1/2)/10 - 2/5))/(2*pi), 'integer') |...  
 in((z1 + asin(6^(1/2)/10 - 2/5))/(2*pi), 'integer'))  
(in((z1 - asin(6^(1/2)/10 + 2/5))/(2*pi), 'integer') |...  
 in((z1 - pi + asin(6^(1/2)/10 + 2/5))/(2*pi), 'integer')) &...  
(in((z - acos(2/5 - 6^(1/2)/10))/(2*pi), 'integer') |...  
 in((z + acos(2/5 - 6^(1/2)/10))/(2*pi), 'integer'))
```

Solve a System of Equations Under Conditions

To solve the system of equations under conditions, specify the conditions in the input to `solve`.

Solve the system of equations considered above for x and y in the interval -2π to 2π . Overlay the solutions on the plot using `scatter`.

```
Srange = solve(eqn1, eqn2, -2*pi<x, x<2*pi, -2*pi<y, y<2*pi, 'ReturnConditions', true);  
scatter(Srange.x, Srange.y, 'k')
```

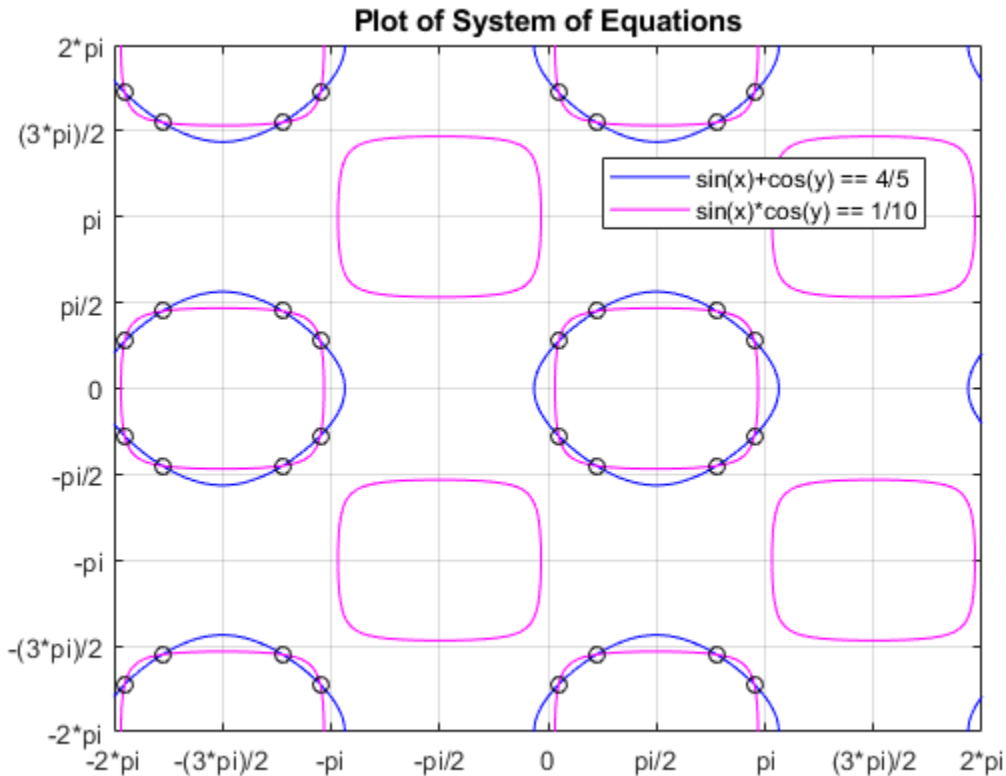
Work with Solutions, Parameters, and Conditions Returned by solve

You can use the solutions, parameters, and conditions returned by `solve` to find solutions within an interval or under additional conditions. This section has the same goal as the previous section, to solve the system of equations within a search range, but with a different approach. Instead of placing conditions directly, it shows how to work with the parameters and conditions returned by `solve`.

For the full solution `S` of the system of equations, find values of `x` and `y` in the interval -2π to 2π by solving the solutions `S.x` and `S.y` for the parameters `S.parameters` within that interval under the condition `S.conditions`.

Before solving for `x` and `y` in the interval, assume the conditions in `S.conditions` using `assume` so that the solutions returned satisfy the condition. Assume the conditions for the first solution.

```
assume(S.conditions(1))
```

Find the parameters in `S.x` and `S.y`.

```
paramx = intersect(symvar(S.x), S.parameters)
paramy = intersect(symvar(S.y), S.parameters)
```

```
paramx =
z1
paramy =
z
```

Solve the first solution of `x` for the parameter `paramx`.

```
solparamx(1,:) = solve(S.x(1) > -2*pi, S.x(1) < 2*pi, paramx)
```

```
solparamx =
[ pi + asin(6^(1/2)/10 - 2/5), asin(6^(1/2)/10 - 2/5) - pi,
 -asin(6^(1/2)/10 - 2/5), - 2*pi - asin(6^(1/2)/10 - 2/5)]
```

Similarly, solve the first solution of y for $paramy$.

```
solparamy(1,:) = solve(S.y(1) > -2*pi, S.y(1) < 2*pi, paramy)
```

```
solparamy =
[ acos(6^(1/2)/10 + 2/5), acos(6^(1/2)/10 + 2/5) - 2*pi,
 -acos(6^(1/2)/10 + 2/5), 2*pi - acos(6^(1/2)/10 + 2/5)]
```

Clear the assumptions set by $S.conditions(1)$ using `assume`. Call `assumptions` to check that the assumptions are cleared.

```
assume(S.parameters, 'clear')
assumptions
```

```
ans =
Empty sym: 1-by-0
```

Assume the conditions for the second solution.

```
assume(S.conditions(2))
```

Solve the second solution to x and y for the parameters $paramx$ and $paramy$.

```
solparamx(2,:) = solve(S.x(2) > -2*pi, S.x(2) < 2*pi, paramx)
solparamy(2,:) = solve(S.y(2) > -2*pi, S.y(2) < 2*pi, paramy)
```

```
solparamx =
[ pi + asin(6^(1/2)/10 - 2/5), asin(6^(1/2)/10 - 2/5) - pi,
 -asin(6^(1/2)/10 - 2/5), - 2*pi - asin(6^(1/2)/10 - 2/5)]
[ asin(6^(1/2)/10 + 2/5), pi - asin(6^(1/2)/10 + 2/5),
 asin(6^(1/2)/10 + 2/5) - 2*pi, - pi - asin(6^(1/2)/10 + 2/5)]
solparamy =
[ acos(6^(1/2)/10 + 2/5), acos(6^(1/2)/10 + 2/5) - 2*pi,
 -acos(6^(1/2)/10 + 2/5), 2*pi - acos(6^(1/2)/10 + 2/5)]
[ acos(2/5 - 6^(1/2)/10), acos(2/5 - 6^(1/2)/10) - 2*pi,
 -acos(2/5 - 6^(1/2)/10), 2*pi - acos(2/5 - 6^(1/2)/10)]
```

The first rows of $paramx$ and $paramy$ form the first solution to the system of equations, and the second rows form the second solution.

To find the values of x and y for these values of $paramx$ and $paramy$, use `subs` to substitute for $paramx$ and $paramy$ in $S.x$ and $S.y$.

```
solx(1,:) = subs(S.x(1), paramx, solparamx(1,:));
solx(2,:) = subs(S.x(2), paramx, solparamx(2,:));
soly(1,:) = subs(S.y(1), paramy, solparamy(1,:));
soly(2,:) = subs(S.y(2), paramy, solparamy(2,:));
```

```
solx =
[ pi + asin(6^(1/2)/10 - 2/5), asin(6^(1/2)/10 - 2/5) - pi,
 -asin(6^(1/2)/10 - 2/5), - 2*pi - asin(6^(1/2)/10 - 2/5)]
[ asin(6^(1/2)/10 + 2/5), pi - asin(6^(1/2)/10 + 2/5),
 asin(6^(1/2)/10 + 2/5) - 2*pi, - pi - asin(6^(1/2)/10 + 2/5)]
```

```

soly =
[ acos(6^(1/2)/10 + 2/5), acos(6^(1/2)/10 + 2/5) - 2*pi,
 -acos(6^(1/2)/10 + 2/5), 2*pi - acos(6^(1/2)/10 + 2/5)]
[ acos(2/5 - 6^(1/2)/10), acos(2/5 - 6^(1/2)/10) - 2*pi,
 -acos(2/5 - 6^(1/2)/10), 2*pi - acos(2/5 - 6^(1/2)/10)]

```

Note that `solx` and `soly` are the two sets of solutions to x and to y . The full sets of solutions to the system of equations are the two sets of points formed by all possible combinations of the values in `solx` and `soly`.

Plot these two sets of points using `scatter`. Overlay them on the plot of the equations. As expected, the solutions appear at the intersection of the plots of the two equations.

```

for i = 1:length(solx(1,:))
    for j = 1:length(soly(1,:))
        scatter(solx(1,i), soly(1,j), 'k')
        scatter(solx(2,i), soly(2,j), 'k')
    end
end
end

```

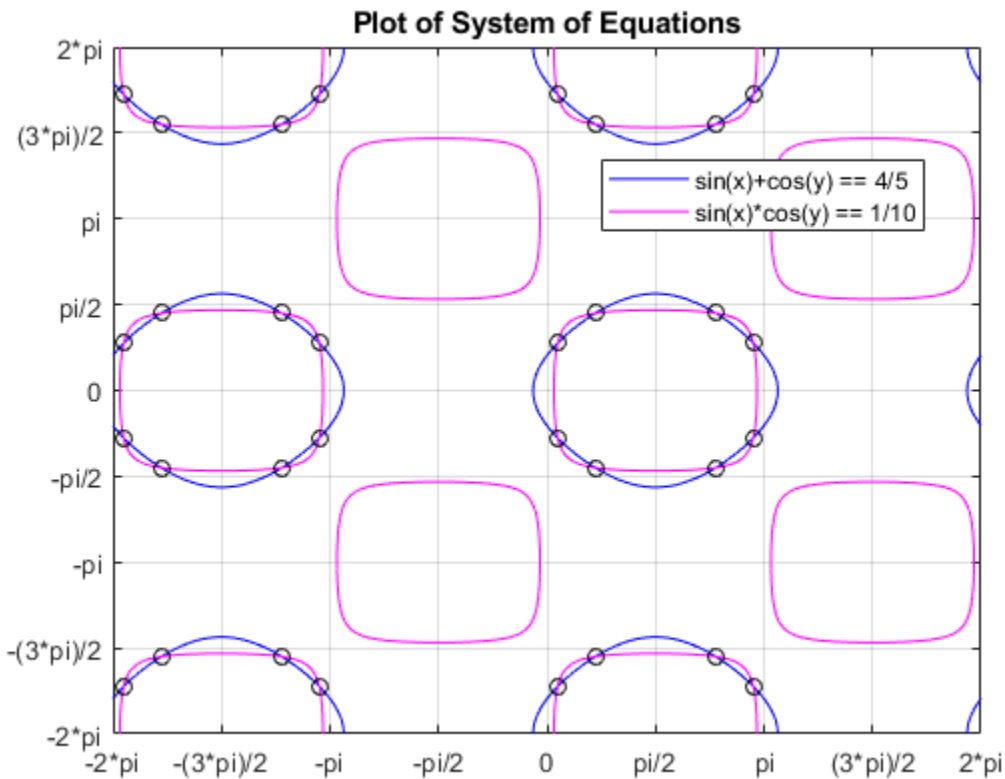

Convert Symbolic Results to Numeric Values

Symbolic calculations provide exact accuracy, while numeric calculations are approximations. Despite this loss of accuracy, you might need to convert symbolic results to numeric approximations for use in numeric calculations. For a high-accuracy conversion, use variable-precision arithmetic provided by the `vpa` function. For standard accuracy and better performance, convert to double precision using `double`.

Use `vpa` to convert the symbolic solutions `solx` and `soly` to numeric form.

```
vpa(solx)
vpa(soly)
```

```
ans =
[ 2.9859135500977407388300518406219, ...
 -3.2972717570818457380952349259371, ...
  0.15567910349205249963259154265761, ...
 -6.1275062036875339772926952239014]
...
[ 0.70095651347102524787213653614929, ...
  2.4406361401187679905905068471302, ...
 -5.5822287937085612290531502304097, ...
 -3.8425491670608184863347799194288]

ans =
[ 0.86983981332387137135918515549046, ...
 -5.4133454938557151055661016110685, ...
 -0.86983981332387137135918515549046, ...
  5.4133454938557151055661016110685]
...
[ 1.4151172233028441195987301489821, ...
 -4.8680680838767423573265566175769, ...
 -1.4151172233028441195987301489821, ...
  4.8680680838767423573265566175769]
```

Simplify Complicated Results and Improve Performance

If results look complicated, `solve` is stuck, or if you want to improve performance, see, “Troubleshoot Equation Solutions from `solve` Function” on page 2-169.

Troubleshoot Equation Solutions from solve Function

If `solve` returns solutions that look complicated, or if `solve` cannot handle an input, there are many options. These options simplify the solution space for `solve`. These options also help `solve` when the input is complicated, and might allow `solve` to return a solution where it was previously stuck.

In this section...
"Return Only Real Solutions" on page 2-169
"Apply Simplification Rules" on page 2-169
"Use Assumptions to Narrow Results" on page 2-170
"Simplify Solutions" on page 2-171
"Tips" on page 2-171

Return Only Real Solutions

Solve the equation $x^5 - 1 == 0$. This equation has five solutions.

```
syms x
solve(x^5 - 1 == 0, x)

ans =
- (2^(1/2)*(5 - 5^(1/2))^(1/2)*1i)/4 - 5^(1/2)/4 - 1/4
(2^(1/2)*(5 - 5^(1/2))^(1/2)*1i)/4 - 5^(1/2)/4 - 1/4
5^(1/2)/4 - (2^(1/2)*(5^(1/2) + 5)^(1/2)*1i)/4 - 1/4
5^(1/2)/4 + (2^(1/2)*(5^(1/2) + 5)^(1/2)*1i)/4 - 1/4
```

If you only need real solutions, specify the `Real` option as `true`. The `solve` function returns the one real solution.

```
solve(x^5 - 1, x, 'Real', true)

ans =
1
```

Apply Simplification Rules

Solve the following equation. The `solve` function returns a complicated solution.

```
syms x
solve(x^(5/2) + 1/x^(5/2) == 1, x)

ans =
1/(1/2 - (3^(1/2)*1i)/2)^(2/5)
1/((3^(1/2)*1i)/2 + 1/2)^(2/5)
-(5^(1/2)/4 - (2^(1/2)*(5 - 5^(1/2))^(1/2)*1i)/4 + 1/4)/(1/2 - (3^(1/2)*1i)/2)^(2/5)
-((2^(1/2)*(5 - 5^(1/2))^(1/2)*1i)/4 + 5^(1/2)/4 + 1/4)/(1/2 - (3^(1/2)*1i)/2)^(2/5)
-(5^(1/2)/4 - (2^(1/2)*(5 - 5^(1/2))^(1/2)*1i)/4 + 1/4)/(1/2 + (3^(1/2)*1i)/2)^(2/5)
-((2^(1/2)*(5 - 5^(1/2))^(1/2)*1i)/4 + 5^(1/2)/4 + 1/4)/(1/2 + (3^(1/2)*1i)/2)^(2/5)
```

To apply simplification rules when solving equations, specify the `IgnoreAnalyticConstraints` option as `true`. The applied simplification rules are not generally correct mathematically but might produce useful solutions, especially in physics and engineering. With this option, the solver does not guarantee the correctness and completeness of the result.

```
solve(x^(5/2) + 1/x^(5/2) == 1, x, 'IgnoreAnalyticConstraints', true)
```

```
ans =
  1/(1/2 - (3^(1/2)*1i)/2)^(2/5)
  1/((3^(1/2)*1i)/2 + 1/2)^(2/5)
```

This solution is simpler and more usable.

Use Assumptions to Narrow Results

For solutions to specific cases, set assumptions to return appropriate solutions. Solve the following equation. The `solve` function returns seven solutions.

```
syms x
solve(x^7 + 2*x^6 - 59*x^5 - 106*x^4 + 478*x^3 + 284*x^2 - 1400*x + 800, x)
```

```
ans =
      1
    - 5^(1/2) - 1
  - 17^(1/2)/2 - 1/2
  17^(1/2)/2 - 1/2
    -5*2^(1/2)
     5*2^(1/2)
    5^(1/2) - 1
```

Assume x is a positive number and solve the equation again. The `solve` function only returns the four positive solutions.

```
assume(x > 0)
solve(x^7 + 2*x^6 - 59*x^5 - 106*x^4 + 478*x^3 + 284*x^2 - 1400*x + 800, x)
```

```
ans =
      1
  17^(1/2)/2 - 1/2
     5*2^(1/2)
    5^(1/2) - 1
```

Place the additional assumption that x is an integer using `in(x, 'integer')`. Place additional assumptions on variables using `assumeAlso`.

```
assumeAlso(in(x, 'integer'))
solve(x^7 + 2*x^6 - 59*x^5 - 106*x^4 + 478*x^3 + 284*x^2 - 1400*x + 800, x)
```

```
ans =
1
```

`solve` returns the only positive, integer solution to x .

Clear the assumptions on x for further computations by recreating it using `syms`.

```
syms x
```

Alternatively, to make several assumptions, use the `&` operator. Make the following assumptions, and solve the following equations.

```
syms a b c f g h y
assume(f == c & a == h & a~= 0)
S = solve([a*x + b*y == c, h*x - g*y == f], [x, y], 'ReturnConditions', true);
```

```
S.x
S.y
S.conditions
```

```
ans =
f/h
ans =
0
ans =
b + g ~= 0
```

Under the specified assumptions, the solution is $x = f/h$ and $y = 0$ under the condition $b + g \approx 0$.

Clear the assumptions on the variables for further computations by recreating them using `syms`.

```
syms a c f h
```

Simplify Solutions

The `solve` function does not call simplification functions for the final results. To simplify the solutions, call `simplify`.

Solve the following equation. Convert the numbers to symbolic numbers using `sym` to return a symbolic result.

```
syms x
S = solve((sin(x) - 2*cos(x))/(sin(x) + 2*cos(x)) == 1/2, x)
```

```
S =
-log((- 140/37 + 48i/37)^(1/2)/2)*1i
-log((- 140/37 + 48i/37)^(1/2)/2)*1i
```

Call `simplify` to simplify solution `S`.

```
simplify(S)
ans =
-log(37^(1/2)*(- 1/37 - 6i/37))*1i
log(2)*1i - (log(- 140/37 + 48i/37)*1i)/2
```

Call `simplify` with more steps to simplify the result even further.

```
simplify(S, 'Steps', 50)
ans =
atan(6) - pi
atan(6)
```

Tips

- To represent a number exactly, use `sym` to convert the number to a floating-point object. For example, use `sym(13)/5` instead of `13/5`. This represents `13/5` exactly instead of converting `13/5` to a floating-point number. For a large number, place the number in quotes. Compare `sym(13)/5`, `sym(13333333333333333333)/5`, and `sym('13333333333333333333')/5`.

```
sym(13)/5  
sym(13333333333333333333333333333333)/5  
sym('13333333333333333333333333333333')/5
```

```
ans =  
13/5  
ans =  
13333333333333333333333333333333/5  
ans =  
13333333333333333333333333333333/5
```

Placing the number in quotes and using `sym` provides the highest accuracy.

- If possible, simplify the system of equations manually before using `solve`. Try to reduce the number of equations, parameters, and variables.

Solve System of Linear Equations

This section shows you how to solve a system of linear equations using the Symbolic Math Toolbox.

In this section...

“Solve System of Linear Equations Using `linsolve`” on page 2-173

“Solve System of Linear Equations Using `solve`” on page 2-174

Solve System of Linear Equations Using `linsolve`

A system of linear equations

$$a_{11}x_1 + a_{12}x_2 + \dots + a_{1n}x_n = b_1$$

$$a_{21}x_1 + a_{22}x_2 + \dots + a_{2n}x_n = b_2$$

...

$$a_{m1}x_1 + a_{m2}x_2 + \dots + a_{mn}x_n = b_m$$

can be represented as the matrix equation $A \cdot \vec{x} = \vec{b}$, where A is the coefficient matrix,

$$A = \begin{pmatrix} a_{11} & \dots & a_{1n} \\ \vdots & \ddots & \vdots \\ a_{m1} & \dots & a_{mn} \end{pmatrix}$$

and \vec{b} is the vector containing the right sides of equations,

$$\vec{b} = \begin{pmatrix} b_1 \\ \vdots \\ b_m \end{pmatrix}$$

If you do not have the system of linear equations in the form $AX = B$, use `equationsToMatrix` to convert the equations into this form. Consider the following system.

$$2x + y + z = 2$$

$$-x + y - z = 3$$

$$x + 2y + 3z = -10$$

Declare the system of equations.

```
syms x y z
eqn1 = 2*x + y + z == 2;
eqn2 = -x + y - z == 3;
eqn3 = x + 2*y + 3*z == -10;
```

Use `equationsToMatrix` to convert the equations into the form $AX = B$. The second input to `equationsToMatrix` specifies the independent variables in the equations.

```
[A,B] = equationsToMatrix([eqn1, eqn2, eqn3], [x, y, z])
```

```
A =
[ 2, 1, 1]
```

```
[ -1, 1, -1]
[  1, 2,  3]
```

```
B =
     2
     3
    -10
```

Use `linsolve` to solve $AX = B$ for the vector of unknowns X .

```
X = linsolve(A,B)
```

```
X =
     3
     1
    -5
```

From X , $x = 3$, $y = 1$ and $z = -5$.

Solve System of Linear Equations Using `solve`

Use `solve` instead of `linsolve` if you have the equations in the form of expressions and not a matrix of coefficients. Consider the same system of linear equations.

$$\begin{aligned}2x + y + z &= 2 \\ -x + y - z &= 3 \\ x + 2y + 3z &= -10\end{aligned}$$

Declare the system of equations.

```
syms x y z
eqn1 = 2*x + y + z == 2;
eqn2 = -x + y - z == 3;
eqn3 = x + 2*y + 3*z == -10;
```

Solve the system of equations using `solve`. The inputs to `solve` are a vector of equations, and a vector of variables to solve the equations for.

```
sol = solve([eqn1, eqn2, eqn3], [x, y, z]);
xSol = sol.x
ySol = sol.y
zSol = sol.z
```

```
xSol =
     3
ySol =
     1
zSol =
    -5
```

`solve` returns the solutions in a structure array. To access the solutions, index into the array.

See Also

More About

- “Solve Algebraic Equation” on page 2-153
- “Solve System of Algebraic Equations” on page 2-160

Solve Equations Numerically

Symbolic Math Toolbox™ offers both numeric and symbolic equation solvers. For a comparison of numeric and symbolic solvers, see “Select Numeric or Symbolic Solver” on page 2-159. An equation or a system of equations can have multiple solutions. To find these solutions numerically, use the function `vpasolve`. For polynomial equations, `vpasolve` returns all solutions. For nonpolynomial equations, `vpasolve` returns the first solution it finds. These examples show you how to use `vpasolve` to find solutions to both polynomial and nonpolynomial equations, and how to obtain these solutions to arbitrary precision.

Find All Roots of a Polynomial Function

Use `vpasolve` to find all the solutions to the function $f(x) = 6x^7 - 2x^6 + 3x^3 - 8$.

```
syms f(x)
f(x) = 6*x^7-2*x^6+3*x^3-8;
sol = vpasolve(f)

sol =
    1.0240240759053702941448316563337
    -0.88080620051762149639205672298326 + 0.50434058840127584376331806592405 i
    -0.88080620051762149639205672298326 - 0.50434058840127584376331806592405 i
    -0.22974795226118163963098570610724 + 0.96774615576744031073999010695171 i
    -0.22974795226118163963098570610724 - 0.96774615576744031073999010695171 i
    0.7652087814927846556172932675903 + 0.83187331431049713218367239317121 i
    0.7652087814927846556172932675903 - 0.83187331431049713218367239317121 i
```

`vpasolve` returns seven roots of the function, as expected, because the function is a polynomial of degree seven.

Find Zeros of a Nonpolynomial Function Using Search Ranges and Starting Points

A plot of the function $f(x) = e^{(x/7)}\cos(2x)$ reveals periodic zeros, with increasing slopes at the zero points as x increases.

```
syms x
h = fplot(exp(x/7)*cos(2*x), [-2 25]);
grid on
```

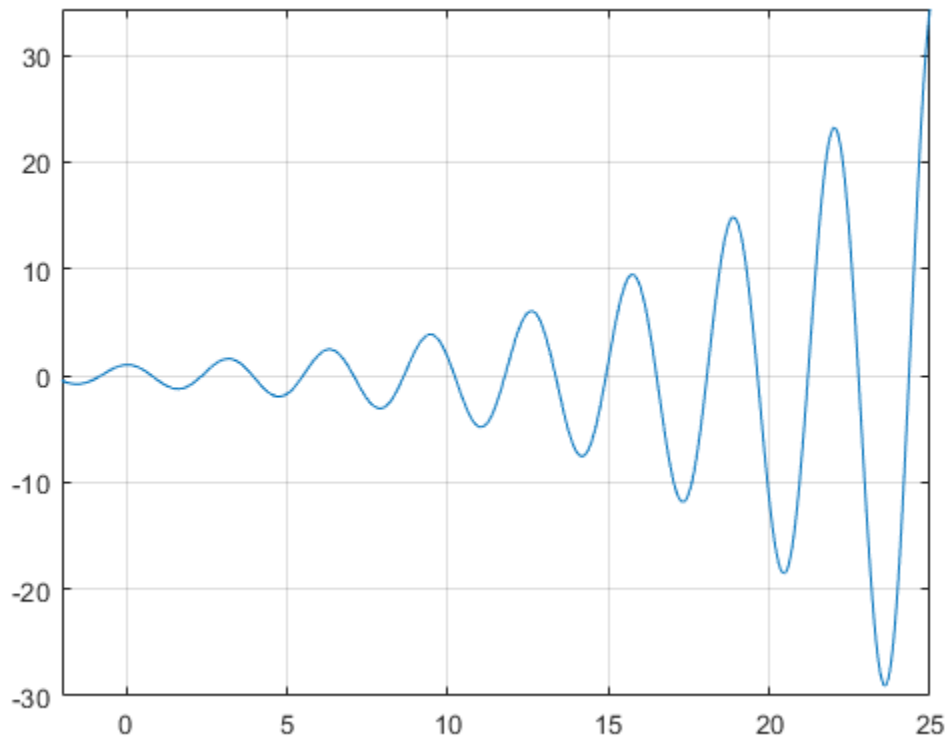

Use `vpasolve` to find a zero of the function `f`. Note that `vpasolve` returns only one solution of a nonpolynomial equation, even if multiple solutions exist. On repeated calls, `vpasolve` returns the same result.

```
f = exp(x/7)*cos(2*x);
for k = 1:3
    vpasolve(f,x)
end

ans = -7.0685834705770347865409476123789
ans = -7.0685834705770347865409476123789
ans = -7.0685834705770347865409476123789
```

To find multiple solutions, set the option `'Random'` to `true`. This makes `vpasolve` choose starting points randomly. For information on the algorithm that chooses random starting points, see “Algorithms” on page 4-1441 on the `vpasolve` page.

```
for k = 1:3
    vpasolve(f,x,'Random',true)
end

ans = -226.98006922186256147892598444194
ans = 98.174770424681038701957605727484
ans = 52.621676947629036744249276669932
```

To find a zero close to $x = 10$, set the starting point to 10.

```
vpasolve(f,x,10)
```

```
ans = 10.210176124166828025003590995658
```

To find a zero close to $x = 1000$, set the starting point to 1000.

```
vpasolve(f,x,1000)
```

```
ans = 999.8118620049516981407362567287
```

To find a zero in the range $15 \leq x \leq 25$, set the search range to [15 25].

```
vpasolve(f,x,[15 25])
```

```
ans = 21.205750411731104359622842837137
```

To find multiple zeros in the range [15 25], you cannot call `vpasolve` repeatedly because it returns the same result on each call, as previously shown. Instead, set the search range and set 'Random' to true.

```
for k = 1:3
    vpasolve(f,x,[15 25],'Random',true)
end
```

```
ans = 21.205750411731104359622842837137
```

```
ans = 21.205750411731104359622842837137
```

```
ans = 16.493361431346414501928877762217
```

Because 'Random' selects starting points randomly, the same solution might be found on successive calls.

Find All Zeros in a Specified Search Range

Create a function `findzeros` to systematically find all zeros for `f` in a given search range, within a specified error tolerance. The function starts with the input search range and calls `vpasolve` to find a zero. Then, it splits the search range into two around the zero value and recursively calls itself with the new search ranges as inputs to find more zeros.

The function is explained section by section here.

Declare the function with the three inputs and one output. The first input is the function, the second input is the range, and the optional third input allows you to specify the error between a zero and the higher and lower bounds generated from it.

```
function sol = findzeros(f,range,err)
```

If you do not specify the optional argument for error tolerance, `findzeros` sets `err` to 0.001.

```
if nargin < 2
    err = 1e-3;
end
```

Find a zero in the search range using `vpasolve`.

```
sol = vpasolve(f,range);
```

If `vpasolve` does not find a zero, exit.

```
if isempty(sol)
    return
```

If `vpasolve` finds a zero, split the search range into two search ranges above and below the zero.

```
else
    lowLimit = sol-err;
    highLimit = sol+err;
```

Call `findzeros` with the lower search range. If `findzeros` returns zeros, copy the values into the solution array and sort them.

```
temp = findzeros(f,[range(1) lowLimit],1);
if ~isempty(temp)
    sol = sort([sol temp]);
end
```

Call `findzeros` with the higher search range. If `findzeros` returns zeros, copy the values into the solution array and sort them.

```
temp = findzeros(f,[highLimit range(2)],1);
if ~isempty(temp)
    sol = sort([sol temp]);
end
return
end
end
```

The entire function `findzeros` is as follows. Save this function as `findzeros.m` in the current folder.

```
function sol = findzeros(f,range,err)
if nargin < 3
    err = 1e-3;
end
sol = vpasolve(f,range);
if isempty(sol)
    return
else
    lowLimit = sol-err;
    highLimit = sol+err;
    temp = findzeros(f,[range(1) lowLimit],1);
    if ~isempty(temp)
        sol = sort([sol temp]);
    end
    temp = findzeros(f,[highLimit range(2)],1);
    if ~isempty(temp)
        sol = sort([sol temp]);
    end
    return
end
end
```

Call `findzeros` with search range `[15 25]` to find all zeros in that range for $f(x) = \exp(x/7) \cdot \cos(2 \cdot x)$, within the default error tolerance.

```
syms f(x)
f(x) = exp(x/7)*cos(2*x);
sol = findzeros(f,[15 25])'

sol =
    (16.493361431346414501928877762217)
    (18.064157758141311121160199453857)
    (19.634954084936207740391521145497)
    (21.205750411731104359622842837137)
    (22.776546738526000978854164528776)
    (24.347343065320897598085486220416)
```

Obtain Solutions to Arbitrary Precision

Use `digits` to set the precision of the solutions returned by `vpasolve`. By default, `vpasolve` returns solutions to a precision of 32 significant figures.

```
f = exp(x/7)*cos(2*x);
vpasolve(f)

ans = -7.0685834705770347865409476123789
```

Use `digits` to increase the precision to 64 significant figures. When modifying `digits`, ensure that you save its current value so that you can restore it.

```
digitsOld = digits;
digits(64)
vpasolve(f)

ans = -7.068583470577034786540947612378881489443631148593988097193625333
```

Next, change the precision of the solutions to 16 significant figures.

```
digits(16)
```

Solve Multivariate Equations Using Search Ranges

Consider the following system of equations.

$$\begin{aligned} z &= 10(\cos(x) + \cos(y)) \\ z &= x + y^2 - 0.1x^2y \\ x + y - 2.7 &= 0 \end{aligned}$$

A plot of the equations for $0 \leq x \leq 2.5$ and $0 \leq y \leq 2.5$ shows that the three surfaces intersect in two points. To better visualize the plot, use `view`. To scale the colormap values, use `caxis`.

```
syms x y z
eqn1 = z == 10*(cos(x) + cos(y));
eqn2 = z == x+y^2-0.1*x^2*y;
eqn3 = x+y-2.7 == 0;
equations = [eqn1 eqn2 eqn3];
fimplicit3(equations)
axis([0 2.5 0 2.5 -20 10])
title('System of Multivariate Equations')
view(69, 28)
caxis([-15 10])
```

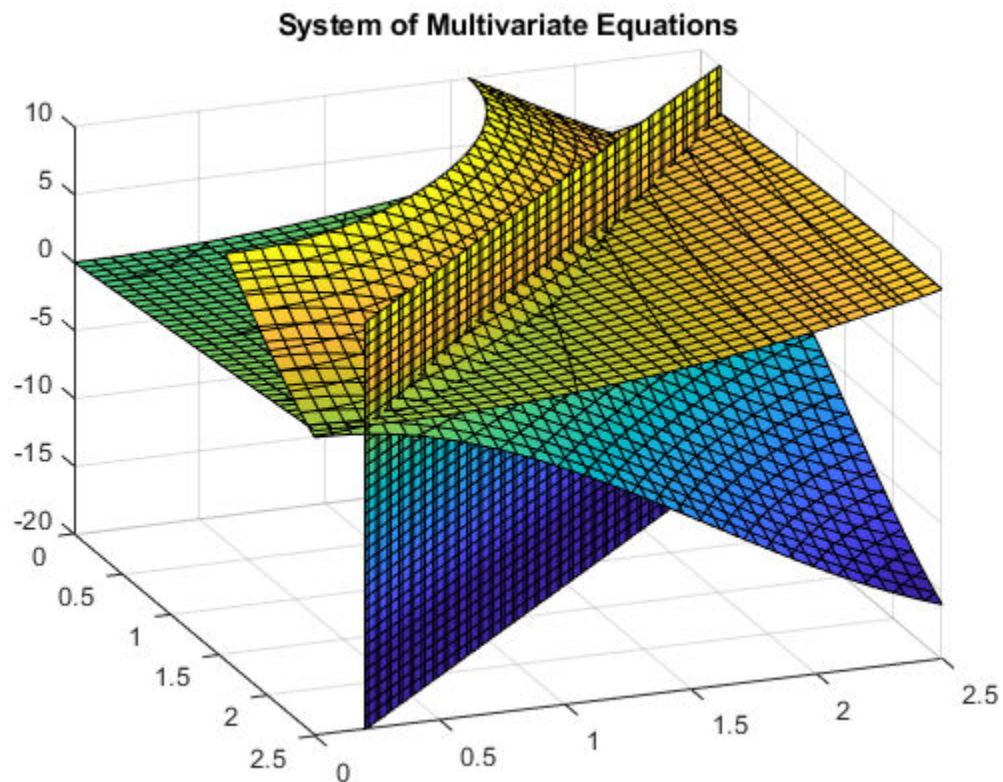



Use `vpasolve` to find a point where the surfaces intersect. The function `vpasolve` returns a structure. To access the `x`-, `y`-, and `z`-values of the solution, index into the structure.

```
sol = vpasolve(equations);  
[sol.x sol.y sol.z]
```

```
ans = (2.369747722454798 0.3302522775452021 2.293354376823228)
```

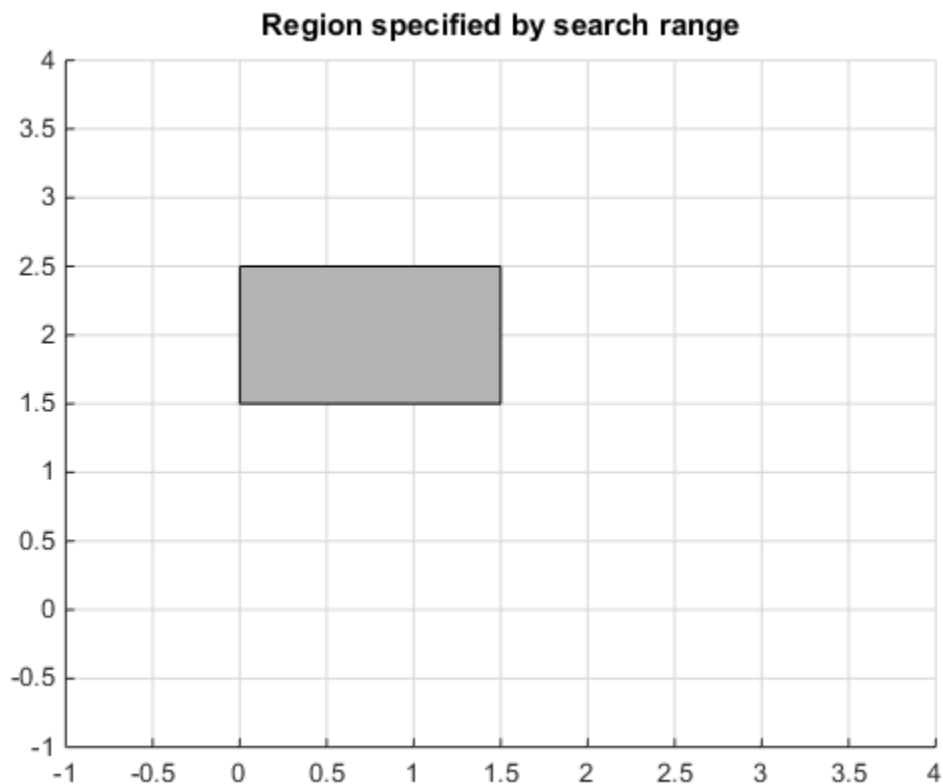
To search a region of the solution space, specify search ranges for the variables. If you specify the ranges $0 \leq x \leq 1.5$ and $1.5 \leq y \leq 2.5$, then `vpasolve` function searches the bounded area shown.



Use `vpasolve` to find a solution for this search range. To omit a search range for z , set the third search range to `[NaN NaN]`.

```
vars = [x y z];
range = [0 1.5; 1.5 2.5; NaN NaN];
sol = vpasolve(equations, vars, range);
[sol.x sol.y sol.z]
```

```
ans = (0.9106266172563336 1.789373382743666 3.964101572135625)
```

To find multiple solutions, set the `'Random'` option to `true`. This makes `vpasolve` use random starting points on successive runs. The `'Random'` option can be used in conjunction with search ranges to make `vpasolve` use random starting points within a search range. Because `'Random'` selects starting points randomly, the same solution might be found on successive calls. Call `vpasolve` repeatedly to ensure you find both solutions.

```
clear sol
range = [0 3; 0 3; NaN NaN];
for k = 1:5
    temp = vpasolve(equations, vars, range, 'Random', true);
    sol(k,1) = temp.x;
    sol(k,2) = temp.y;
    sol(k,3) = temp.z;
end
sol
```

```
sol =
```

```
(
2.369747722454798 0.3302522775452021 2.293354376823228)
2.369747722454798 0.3302522775452021 2.293354376823228)
2.369747722454798 0.330252277545202 2.293354376823228)
0.9106266172563336 1.789373382743666 3.964101572135625)
0.9106266172563336 1.789373382743666 3.964101572135625)
```

Plot the equations. Superimpose the solutions as a scatter plot of points with yellow X markers using `scatter3`. To better visualize the plot, make two of the surfaces transparent using `alpha`. Scale the colormap to the plot values using `caxis`, and change the perspective using `view`.

`vpasolve` finds solutions at the intersection of the surfaces formed by the equations as shown.

```
clf
ax = axes;
h = fimplicit3(equations);
h(2).FaceAlpha = 0;
h(3).FaceAlpha = 0;
axis([0 2.5 0 2.5 -20 10])
hold on
scatter3(sol(:,1),sol(:,2),sol(:,3),600,'yellow','X','LineWidth',2)
title('Randomly Found Solutions in Specified Search Range')
cz = ax.Children;
caxis([0 20])
view(69,28)
hold off
```

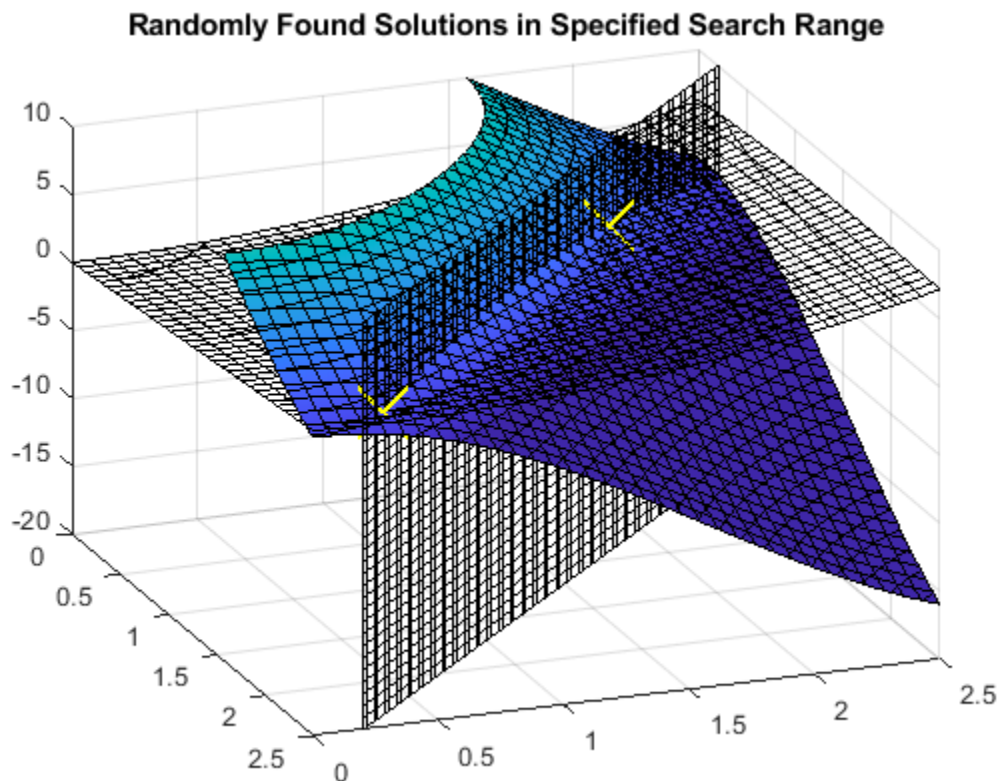

Lastly, restore the old value of `digits` for further calculations.

```
digits(digits0ld)
```

Solve Differential Equation

Solve a differential equation analytically by using the `dsolve` function, with or without initial conditions. To solve a system of differential equations, see “Solve a System of Differential Equations” on page 2-189.

In this section...

“First-Order Linear ODE” on page 2-185

“Solve Differential Equation with Condition” on page 2-185

“Nonlinear Differential Equation with Initial Condition” on page 2-186

“Second-Order ODE with Initial Conditions” on page 2-186

“Third-Order ODE with Initial Conditions” on page 2-186

“More ODE Examples” on page 2-187

First-Order Linear ODE

Solve this differential equation.

$$\frac{dy}{dt} = ty.$$

First, represent y by using `syms` to create the symbolic function $y(t)$.

```
syms y(t)
```

Define the equation using `==` and represent differentiation using the `diff` function.

```
ode = diff(y,t) == t*y
```

```
ode(t) =  
diff(y(t), t) == t*y(t)
```

Solve the equation using `dsolve`.

```
ySol(t) = dsolve(ode)
```

```
ySol(t) =  
C1*exp(t^2/2)
```

Solve Differential Equation with Condition

In the previous solution, the constant `C1` appears because no condition was specified. Solve the equation with the initial condition $y(0) == 2$. The `dsolve` function finds a value of `C1` that satisfies the condition.

```
cond = y(0) == 2;  
ySol(t) = dsolve(ode, cond)
```

```
ySol(t) =  
2*exp(t^2/2)
```

If `dsolve` cannot solve your equation, then try solving the equation numerically. See “Solve a Second-Order Differential Equation Numerically” on page 2-157.

Nonlinear Differential Equation with Initial Condition

Solve this nonlinear differential equation with an initial condition. The equation has multiple solutions.

$$\left(\frac{dy}{dt} + y\right)^2 = 1,$$

$$y(0) = 0.$$

```
syms y(t)
ode = (diff(y,t)+y)^2 == 1;
cond = y(0) == 0;
ySol(t) = dsolve(ode,cond)
```

```
ySol(t) =
exp(-t) - 1
1 - exp(-t)
```

Second-Order ODE with Initial Conditions

Solve this second-order differential equation with two initial conditions.

$$\frac{d^2y}{dx^2} = \cos(2x) - y,$$

$$y(0) = 1,$$

$$y'(0) = 0.$$

Define the equation and conditions. The second initial condition involves the first derivative of y . Represent the derivative by creating the symbolic function $Dy = \text{diff}(y)$ and then define the condition using $Dy(0) == 0$.

```
syms y(x)
Dy = diff(y);

ode = diff(y,x,2) == cos(2*x)-y;
cond1 = y(0) == 1;
cond2 = Dy(0) == 0;
```

Solve ode for y . Simplify the solution using the `simplify` function.

```
conds = [cond1 cond2];
ySol(x) = dsolve(ode,conds);
ySol = simplify(ySol)
```

```
ySol(x) =
1 - (8*sin(x/2)^4)/3
```

Third-Order ODE with Initial Conditions

Solve this third-order differential equation with three initial conditions.

$$\frac{d^3u}{dx^3} = u,$$

$$u(0) = 1,$$

$$u'(0) = -1,$$

$$u''(0) = \pi.$$

Because the initial conditions contain the first- and second-order derivatives, create two symbolic functions, $Du = \text{diff}(u,x)$ and $D2u = \text{diff}(u,x,2)$, to specify the initial conditions.

```
syms u(x)
Du = diff(u,x);
D2u = diff(u,x,2);
```

Create the equation and initial conditions, and solve it.

```
ode = diff(u,x,3) == u;
cond1 = u(0) == 1;
cond2 = Du(0) == -1;
cond3 = D2u(0) == pi;
conds = [cond1 cond2 cond3];

uSol(x) = dsolve(ode,conds)

uSol(x) =

(pi*exp(x))/3 - exp(-x/2)*cos((3^(1/2)*x)/2)*(pi/3 - 1) - ...
(3^(1/2)*exp(-x/2)*sin((3^(1/2)*x)/2)*(pi + 1))/3
```

More ODE Examples

This table shows examples of differential equations and their Symbolic Math Toolbox syntax. The last example is the Airy differential equation, whose solution is called the Airy function.

Differential Equation	MATLAB Commands
$\frac{dy}{dt} + 4y(t) = e^{-t},$ $y(0) = 1.$	<pre>syms y(t) ode = diff(y)+4*y == exp(-t); cond = y(0) == 1; ySol(t) = dsolve(ode,cond) ySol(t) = exp(-t)/3 + (2*exp(-4*t))/3</pre>
$2x^2\frac{d^2y}{dx^2} + 3x\frac{dy}{dx} - y = 0.$	<pre>syms y(x) ode = 2*x^2*diff(y,x,2)+3*x*diff(y,x)-y == 0; ySol(x) = dsolve(ode) ySol(x) = C2/(3*x) + C3*x^(1/2)</pre>
The Airy equation. $\frac{d^2y}{dx^2} = xy(x).$	<pre>syms y(x) ode = diff(y,x,2) == x*y; ySol(x) = dsolve(ode) ySol(x) = C1*airy(0,x) + C2*airy(2,x)</pre>

See Also

“Solve a System of Differential Equations” on page 2-189

Solve a System of Differential Equations

Solve a system of several ordinary differential equations in several variables by using the `dsolve` function, with or without initial conditions. To solve a single differential equation, see “Solve Differential Equation” on page 2-185.

In this section...

“Solve System of Differential Equations” on page 2-189

“Solve Differential Equations in Matrix Form” on page 2-191

Solve System of Differential Equations

Solve this system of linear first-order differential equations.

$$\frac{du}{dt} = 3u + 4v,$$

$$\frac{dv}{dt} = -4u + 3v.$$

First, represent u and v by using `syms` to create the symbolic functions $u(t)$ and $v(t)$.

```
syms u(t) v(t)
```

Define the equations using `==` and represent differentiation using the `diff` function.

```
ode1 = diff(u) == 3*u + 4*v;
ode2 = diff(v) == -4*u + 3*v;
odes = [ode1; ode2]
```

```
odes(t) =
 diff(u(t), t) == 3*u(t) + 4*v(t)
 diff(v(t), t) == 3*v(t) - 4*u(t)
```

Solve the system using the `dsolve` function which returns the solutions as elements of a structure.

```
S = dsolve(odes)
```

```
S =
 struct with fields:

    v: [1x1 sym]
    u: [1x1 sym]
```

If `dsolve` cannot solve your equation, then try solving the equation numerically. See “Solve a Second-Order Differential Equation Numerically” on page 2-157.

To access $u(t)$ and $v(t)$, index into the structure S .

```
uSol(t) = S.u
vSol(t) = S.v

uSol(t) =
 C2*cos(4*t)*exp(3*t) + C1*sin(4*t)*exp(3*t)
vSol(t) =
 C1*cos(4*t)*exp(3*t) - C2*sin(4*t)*exp(3*t)
```

Alternatively, store $u(t)$ and $v(t)$ directly by providing multiple output arguments.

```
[uSol(t), vSol(t)] = dsolve(odes)

uSol(t) =
C2*cos(4*t)*exp(3*t) + C1*sin(4*t)*exp(3*t)
vSol(t) =
C1*cos(4*t)*exp(3*t) - C2*sin(4*t)*exp(3*t)
```

The constants $C1$ and $C2$ appear because no conditions are specified. Solve the system with the initial conditions $u(0) == 0$ and $v(0) == 1$. The `dsolve` function finds values for the constants that satisfy these conditions.

```
cond1 = u(0) == 0;
cond2 = v(0) == 1;
conds = [cond1; cond2];
[uSol(t), vSol(t)] = dsolve(odes, conds)

uSol(t) =
sin(4*t)*exp(3*t)
vSol(t) =
cos(4*t)*exp(3*t)
```

Visualize the solution using `fplot`.

```
fplot(uSol)
hold on
fplot(vSol)
grid on
legend('uSol', 'vSol', 'Location', 'best')
```

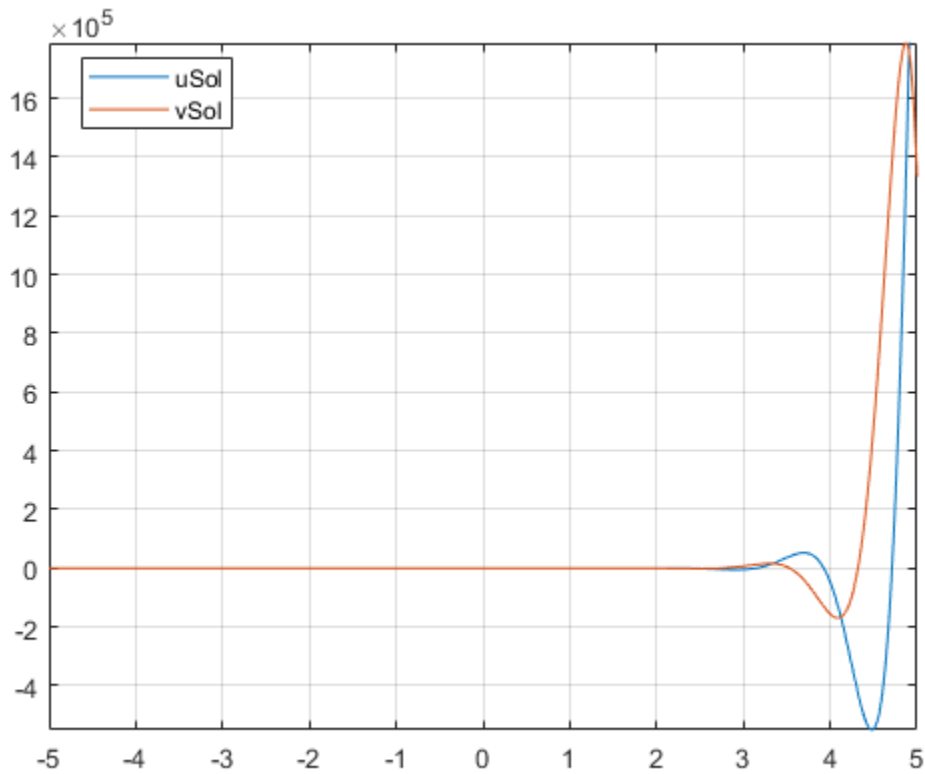

Solve Differential Equations in Matrix Form

Solve differential equations in matrix form by using `dsolve`.

Consider this system of differential equations.

$$\begin{aligned}\frac{dx}{dt} &= x + 2y + 1, \\ \frac{dy}{dt} &= -x + y + t.\end{aligned}$$

The matrix form of the system is

$$\begin{bmatrix} x' \\ y' \end{bmatrix} = \begin{bmatrix} 1 & 2 \\ -1 & 1 \end{bmatrix} \begin{bmatrix} x \\ y \end{bmatrix} + \begin{bmatrix} 1 \\ t \end{bmatrix}.$$

Let

$$Y = \begin{bmatrix} x \\ y \end{bmatrix}, A = \begin{bmatrix} 1 & 2 \\ -1 & 1 \end{bmatrix}, B = \begin{bmatrix} 1 \\ t \end{bmatrix}.$$

The system is now $Y' = AY + B$.

Define these matrices and the matrix equation.

```

syms x(t) y(t)
A = [1 2; -1 1];
B = [1; t];
Y = [x; y];
odes = diff(Y) == A*Y + B

odes(t) =
  diff(x(t), t) == x(t) + 2*y(t) + 1
  diff(y(t), t) == t - x(t) + y(t)

```

Solve the matrix equation using `dsolve`. Simplify the solution by using the `simplify` function.

```

[xSol(t), ySol(t)] = dsolve(odes);
xSol(t) = simplify(xSol(t))
ySol(t) = simplify(ySol(t))

xSol(t) =
(2*t)/3 + 2^(1/2)*C2*exp(t)*cos(2^(1/2)*t) + 2^(1/2)*C1*exp(t)*sin(2^(1/2)*t) + 1/9
ySol(t) =
C1*exp(t)*cos(2^(1/2)*t) - t/3 - C2*exp(t)*sin(2^(1/2)*t) - 2/9

```

The constants `C1` and `C2` appear because no conditions are specified.

Solve the system with the initial conditions $u(0) = 2$ and $v(0) = -1$. When specifying equations in matrix form, you must specify initial conditions in matrix form too. `dsolve` finds values for the constants that satisfy these conditions.

```

C = Y(0) == [2; -1];
[xSol(t), ySol(t)] = dsolve(odes,C)

xSol(t) =
(2*t)/3 + (17*exp(t)*cos(2^(1/2)*t))/9 - (7*2^(1/2)*exp(t)*sin(2^(1/2)*t))/9 + 1/9
ySol(t) =
- t/3 - (7*exp(t)*cos(2^(1/2)*t))/9 - (17*2^(1/2)*exp(t)*sin(2^(1/2)*t))/18 - 2/9

```

Visualize the solution using `fplot`.

```

clf
fplot(ySol)
hold on
fplot(xSol)
grid on
legend('ySol','xSol','Location','best')

```

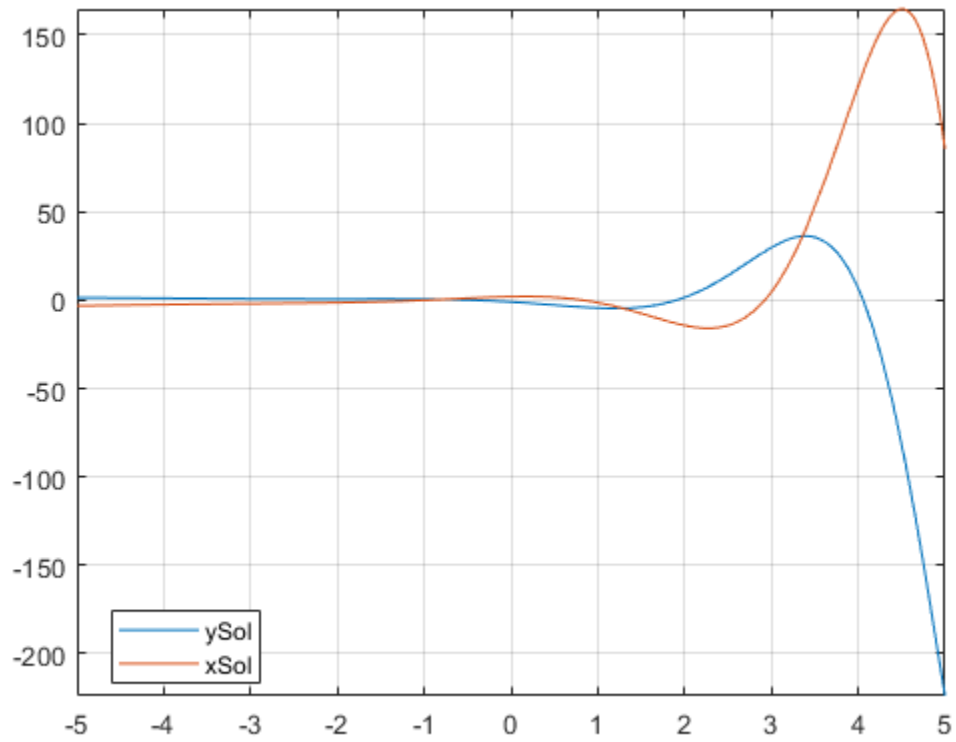
**See Also**

“Solve Differential Equation” on page 2-185

Solve Differential Algebraic Equations (DAEs)

This example shows how to solve differential algebraic equations (DAEs) by using MATLAB® and Symbolic Math Toolbox™.

Differential algebraic equations involving functions, or state variables, $x(t) = [x_1(t), \dots, x_n(t)]$ have the form

$$F(t, x(t), \dot{x}(t)) = 0$$

where t is the independent variable. The number of equations $F = [F_1, \dots, F_n]$ must match the number of state variables $x(t) = [x_1(t), \dots, x_n(t)]$.

Because most DAE systems are not suitable for direct input to MATLAB® solvers, such as `ode15i`, first convert them to a suitable form by using Symbolic Math Toolbox™ functionality. This functionality reduces the differential index (number of differentiations needed to reduce the system to ODEs) of the DAEs to 1 or 0, and then converts the DAE system to numeric function handles suitable for MATLAB® solvers. Then, use MATLAB® solvers, such as `ode15i`, `ode15s`, or `ode23t`, to solve the DAEs.

Solve your DAE system by completing these steps.

Step 1: Specify Equations and Variables

The following figure shows the DAE workflow by solving the DAEs for a pendulum.

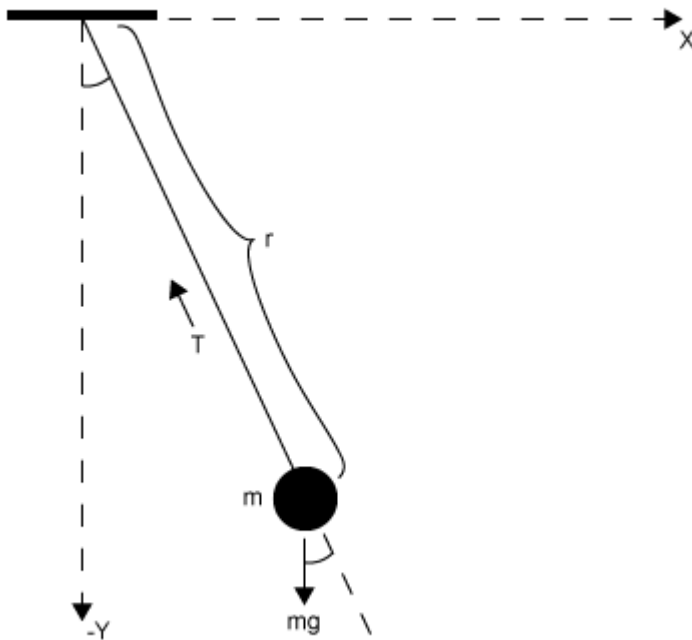

The state variables are:

- Horizontal position of pendulum $x(t)$
- Vertical position of pendulum $y(t)$
- Force preventing pendulum from flying away $T(t)$

The variables are:

- Pendulum mass m
- Pendulum length r
- Gravitational constant g

The DAE system of equations is:

$$m \frac{d^2 x}{dt^2} = T(t) \frac{x(t)}{r}$$

$$m \frac{d^2 y}{dt^2} = T(t) \frac{y(t)}{r} - mg$$

$$x(t)^2 + y(t)^2 = r^2$$

Specify independent variables and state variables by using `syms`.

```
syms x(t) y(t) T(t) m r g
```

Specify equations by using the `==` operator.

```
eqn1 = m*diff(x(t), 2) == T(t)/r*x(t);
eqn2 = m*diff(y(t), 2) == T(t)/r*y(t) - m*g;
eqn3 = x(t)^2 + y(t)^2 == r^2;
eqns = [eqn1 eqn2 eqn3];
```

Place the state variables in a column vector. Store the number of original variables for reference.

```
vars = [x(t); y(t); T(t)];
origVars = length(vars);
```

Step 2: Reduce Differential Order

2.1 (Optional) Check Incidence of Variables

This step is *optional*. You can check where variables occur in the DAE system by viewing the incidence matrix. This step finds any variables that do not occur in your input and can be removed from the `vars` vector.

Display the incidence matrix by using `incidenceMatrix`. The output of `incidenceMatrix` has a row for each equation and a column for each variable. Because the system has three equations and three state variables, `incidenceMatrix` returns a 3-by-3 matrix. The matrix has 1s and 0s, where 1s represent the occurrence of a state variable. For example, the 1 in position (2, 3) means the second equation contains the third state variable $T(t)$.

```
M = incidenceMatrix(eqns, vars)
```

```
M = 3×3
```

```
    1    0    1
```

$$\begin{array}{ccc} 0 & 1 & 1 \\ 1 & 1 & 0 \end{array}$$

If a column of the incidence matrix is all 0s, then that state variable does not occur in the DAE system and should be removed.

2.2 Reduce Differential Order

The *differential order* of a DAE system is the highest differential order of its equations. To solve DAEs using MATLAB, the differential order must be reduced to 1. Here, the first and second equations have second-order derivatives of $x(t)$ and $y(t)$. Thus, the differential order is 2.

Reduce the system to a first-order system by using `reduceDifferentialOrder`. The `reduceDifferentialOrder` function substitutes derivatives with new variables, such as $Dx(t)$ and $Dy(t)$. The right side of the expressions in `eqns` is 0.

```
[eqns,vars] = reduceDifferentialOrder(eqns,vars)
```

$$\text{eqns} = \begin{pmatrix} m \frac{\partial}{\partial t} Dx(t) - \frac{T(t)x(t)}{r} \\ gm + m \frac{\partial}{\partial t} Dy(t) - \frac{T(t)y(t)}{r} \\ -r^2 + x(t)^2 + y(t)^2 \\ Dx(t) - \frac{\partial}{\partial t} x(t) \\ Dy(t) - \frac{\partial}{\partial t} y(t) \end{pmatrix}$$

$$\text{vars} = \begin{pmatrix} x(t) \\ y(t) \\ T(t) \\ Dx(t) \\ Dy(t) \end{pmatrix}$$

Step 3: Check and Reduce Differential Index

3.1 Check Differential Index of System

Check the differential index of the DAE system by using `isLowIndexDAE`. If the index is 0 or 1, then `isLowIndexDAE` returns logical 1 (true) and you can skip step 3.2 and go to Step 4. Convert DAE Systems to MATLAB Function Handles. Here, `isLowIndexDAE` returns logical 0 (false), which means the differential index is greater than 1 and must be reduced.

```
isLowIndexDAE(eqns,vars)
```

```
ans = logical
      0
```

3.2 Reduce Differential Index with `reduceDAEIndex`

To reduce the differential index, the `reduceDAEIndex` function adds new equations that are derived from the input equations, and then replaces higher-order derivatives with new variables. If

`reduceDAEIndex` fails and issues a warning, then use the alternative function `reduceDAEToODE` as described in the workflow “Solve Semilinear DAE System” on page 2-203.

Reduce the differential index of the DAEs described by `eqns` and `vars`.

`[DAEs,DAEvars] = reduceDAEIndex(eqns,vars)`

$$\text{DAEs} = \begin{pmatrix} m \text{Dxtt}(t) - \frac{T(t)x(t)}{r} \\ g m + m \text{Dytt}(t) - \frac{T(t)y(t)}{r} \\ -r^2 + x(t)^2 + y(t)^2 \\ \text{Dxt}(t) - \text{Dxt}_1(t) \\ \text{Dyt}(t) - \text{Dyt}_1(t) \\ 2 \text{Dxt}_1(t)x(t) + 2 \text{Dyt}_1(t)y(t) \\ 2 y(t) \frac{\partial}{\partial t} \text{Dyt}_1(t) + 2 \text{Dxt}_1(t)^2 + 2 \text{Dyt}_1(t)^2 + 2 \text{Dxt}_1(t)x(t) \\ \text{Dxtt}(t) - \text{Dxt}_1t(t) \\ \text{Dytt}(t) - \frac{\partial}{\partial t} \text{Dyt}_1(t) \\ \text{Dyt}_1(t) - \frac{\partial}{\partial t} y(t) \end{pmatrix}$$

$$\text{DAEvars} = \begin{pmatrix} x(t) \\ y(t) \\ T(t) \\ \text{Dxt}(t) \\ \text{Dyt}(t) \\ \text{Dytt}(t) \\ \text{Dxtt}(t) \\ \text{Dxt}_1(t) \\ \text{Dyt}_1(t) \\ \text{Dxt}_1t(t) \end{pmatrix}$$

If `reduceDAEIndex` an error or a warning, use the alternative workflow described in “Solve Semilinear DAE System” on page 2-203.

Often, `reduceDAEIndex` introduces redundant equations and variables that can be eliminated. Eliminate redundant equations and variables using `reduceRedundancies`.

`[DAEs,DAEvars] = reduceRedundancies(DAEs,DAEvars)`

`DAEs =`

$$\begin{pmatrix} -\frac{T(t)x(t) - m r Dxtt(t)}{r} \\ \frac{g m r - T(t)y(t) + m r Dytt(t)}{r} \\ -r^2 + x(t)^2 + y(t)^2 \\ 2 Dxt(t)x(t) + 2 Dyt(t)y(t) \\ 2 Dxt(t)^2 + 2 Dyt(t)^2 + 2 Dxtt(t)x(t) + 2 Dytt(t)y(t) \\ Dytt(t) - \frac{\partial}{\partial t} Dyt(t) \\ Dyt(t) - \frac{\partial}{\partial t} y(t) \end{pmatrix}$$

DAEvars =

$$\begin{pmatrix} x(t) \\ y(t) \\ T(t) \\ Dxt(t) \\ Dyt(t) \\ Dytt(t) \\ Dxtt(t) \end{pmatrix}$$

Check the differential index of the new system. Now, `isLowIndexDAE` returns logical 1 (`true`), which means that the differential index of the system is 0 or 1.

`isLowIndexDAE(DAEs, DAEvars)`

`ans = logical`
1

Step 4: Convert DAE Systems to MATLAB Function Handles

This step creates function handles for the MATLAB® ODE solver `ode15i`, which is a general purpose solver. To use specialized mass matrix solvers such as `ode15s` and `ode23t`, see “Solve DAEs Using Mass Matrix Solvers” on page 2-209 and “Choose an ODE Solver” (MATLAB).

`reduceDAEIndex` outputs a vector of equations in DAEs and a vector of variables in DAEvars. To use `ode15i`, you need a function handle that describes the DAE system.

First, the equations in DAEs can contain symbolic parameters that are not specified in the vector of variables DAEvars. Find these parameters by using `setdiff` on the output of `symvar` from DAEs and DAEvars.

```
pDAEs = symvar(DAEs);
pDAEvars = symvar(DAEvars);
extraParams = setdiff(pDAEs,pDAEvars)
```

```
extraParams = (g m r)
```

The extra parameters that you need to specify are the mass `m`, radius `r`, and gravitational constant `g`.

Create the function handle by using `daeFunction`. Specify the extra symbolic parameters as additional input arguments of `daeFunction`.

```
f = daeFunction(DAEs, DAEvars, g, m, r);
```

The rest of the workflow is purely numerical. Set the parameter values and create the function handle for `ode15i`.

```
g = 9.81;
m = 1;
r = 1;
F = @(t,Y,YP) f(t,Y,YP,g,m,r);
```

Step 5: Find Initial Conditions For Solvers

The `ode15i` solver requires initial values for all variables in the function handle. Find initial values that satisfy the equations by using the MATLAB `decic` function. `decic` accepts guesses (which might not satisfy the equations) for the initial conditions and tries to find satisfactory initial conditions using those guesses. `decic` can fail, in which case you must manually supply consistent initial values for your problem.

First, check the variables in `DAEvars`.

`DAEvars`

```
DAEvars =
    (
     x(t)
     y(t)
     T(t)
     Dxt(t)
     Dyt(t)
     Dytt(t)
     Dxtt(t)
    )
```

Here, $Dxt(t)$ is the first derivative of $x(t)$, $Dytt(t)$ is the second derivative of $y(t)$, and so on. There are 7 variables in a 7-by-1 vector. Therefore, guesses for initial values of variables and their derivatives must also be 7-by-1 vectors.

Assume the initial angular displacement of the pendulum is 30° or $\pi/6$, and the origin of the coordinates is at the suspension point of the pendulum. Given that we used a radius r of 1, the initial horizontal position $x(t)$ is $r \cdot \sin(\pi/6)$. The initial vertical position $y(t)$ is $-r \cdot \cos(\pi/6)$. Specify these initial values of the variables in the vector `y0est`.

Arbitrarily set the initial values of the remaining variables and their derivatives to 0. These are not good guesses. However, they suffice for this problem. In your problem, if `decic` errors, then provide better guesses and refer to `decic`.

```
y0est = [r*sin(pi/6); -r*cos(pi/6); 0; 0; 0; 0; 0];
yp0est = zeros(7,1);
```

Create an option set that specifies numerical tolerances for the numerical search.

```
opt = odeset('RelTol', 10.0^(-7), 'AbsTol', 10.0^(-7));
```

Find consistent initial values for the variables and their derivatives by using `decic`.

```
[y0,yp0] = decic(F,0,y0est,[],yp0est,[],opt)
```

```
y0 = 7×1
    0.4771
```

```
-0.8788  
-8.6214  
 0  
 0.0000  
-2.2333  
-4.1135  
  
yp0 = 7×1  
  
 0  
 0.0000  
 0  
 0  
-2.2333  
 0  
 0
```

Step 6: Solve DAEs Using ode15i

Solve the system integrating over the time span $0 \leq t \leq 0.5$. Add the grid lines and the legend to the plot.

```
[tSol,ySol] = ode15i(F,[0 0.5],y0,yp0,opt);  
plot(tSol,ySol(:,1:origVars),'LineWidth',2)  
  
for k = 1:origVars  
    S{k} = char(DAEvars(k));  
end  
  
legend(S,'Location','Best')  
grid on
```

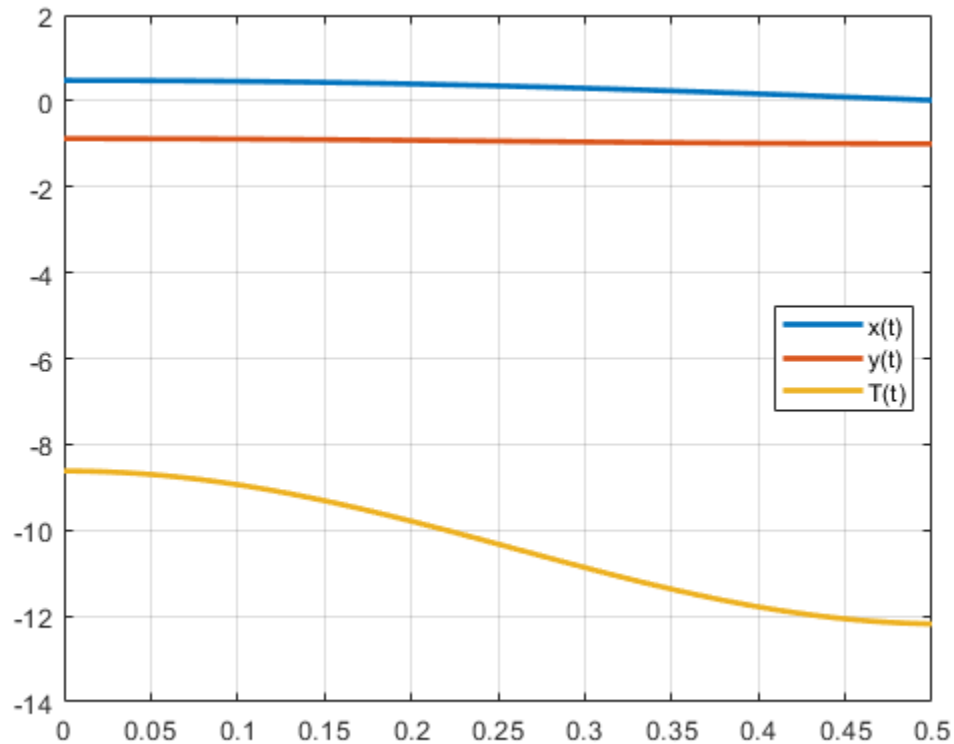

Solve the system for different parameter values by setting the new value and regenerating the function handle and initial conditions.

Set r to 2 and regenerate the function handle and initial conditions.

```
r = 2;
F = @(t,Y,YP)f(t,Y,YP,g,m,r);

y0est = [r*sin(pi/6); -r*cos(pi/6); 0; 0; 0; 0; 0];
[y0,yp0] = decic(F,0,y0est,[],yp0est,[],opt);
```

Solve the system for the new parameter value.

```
[tSol,y] = ode15i(F,[0 0.5],y0,yp0,opt);
plot(tSol,y(:,1:origVars),'LineWidth',2)
```

```
for k = 1:origVars
    S{k} = char(DAEvars(k));
end
legend(S,'Location','Best')
grid on
```

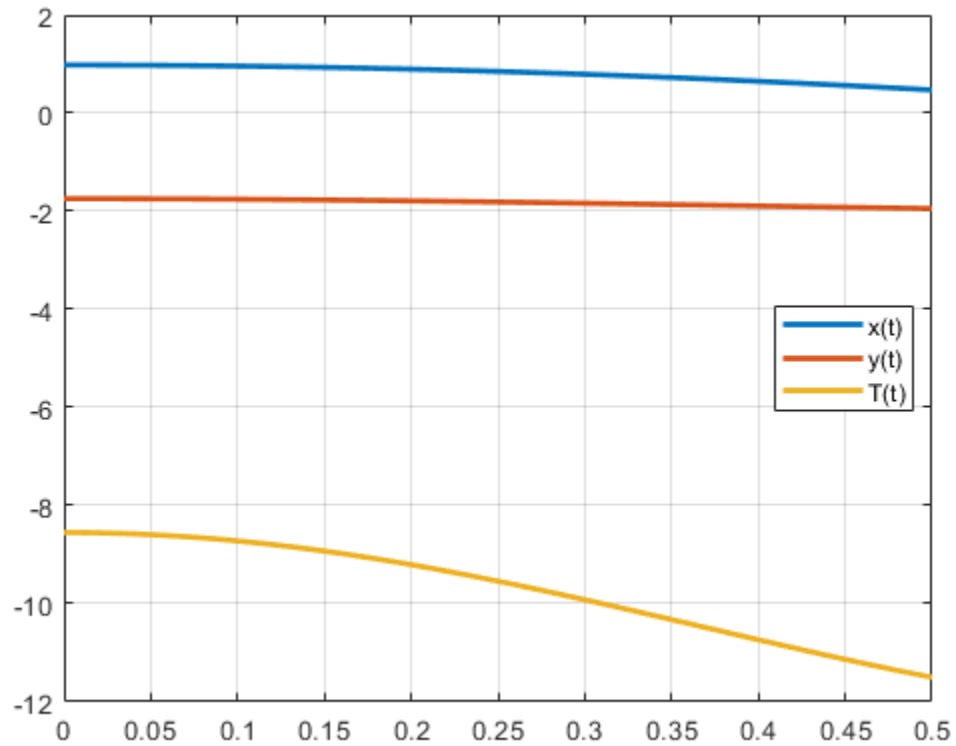

See Also

Related Examples

- “Solve Semilinear DAE System” on page 2-203
- “Solve DAEs Using Mass Matrix Solvers” on page 2-209

Solve Semilinear DAE System

This workflow is an alternative workflow to solving semilinear DAEs, used only if `reduceDAEIndex` failed in the standard workflow with the warning below. For the standard workflow, see “Solve Differential Algebraic Equations (DAEs)” on page 2-194.

Warning: The index of the reduced DAEs is larger... than 1. [daetools::reduceDAEIndex]

To solve your DAE system complete these steps.

- “Step 1. Reduce Differential Index with `reduceDAETToODE`” on page 2-203
- “Step 2. ODEs to Function Handles for `ode15s` and `ode23t`” on page 2-203
- “Step 3. Initial Conditions for `ode15s` and `ode23t`” on page 2-204
- “Step 4. Solve an ODE System with `ode15s` or `ode23t`” on page 2-206

Step 1. Reduce Differential Index with `reduceDAETToODE`

Complete steps 1 and 2 in “Solve Differential Algebraic Equations (DAEs)” on page 2-194 before beginning this step. Then, in step 3 when `reduceDAEIndex` fails, reduce the differential index using `reduceDAETToODE`. The advantage of `reduceDAETToODE` is that it reliably reduces semilinear DAEs to ODEs (DAEs of index 0). However, this function is slower and works only on semilinear DAE systems. `reduceDAETToODE` can fail if the system is not semilinear.

To reduce the differential index of the DAEs described by `eqns` and `vars`, use `reduceDAETToODE`. To reduce the index, `reduceDAETToODE` adds new variables and equations to the system. `reduceDAETToODE` also returns constraints, which are conditions that help find initial values to ensure that the resulting ODEs are equal to the initial DAEs.

```
[ODEs, constraints] = reduceDAETToODE(eqns, vars)
```

```
ODEs =
    Dxt(t) - diff(x(t), t)
    Dyt(t) - diff(y(t), t)
    m*diff(Dxt(t), t) - (T(t)*x(t))/r
    m*diff(Dyt(t), t) - (T(t)*y(t) - g*m*r)/r
    -(4*T(t)*y(t) - 2*g*m*r)*diff(y(t), t) -...
    diff(T(t), t)*(2*x(t)^2 + 2*y(t)^2) -...
    4*T(t)*x(t)*diff(x(t), t) -...
    4*m*r*Dxt(t)*diff(Dxt(t), t) -...
    4*m*r*Dyt(t)*diff(Dyt(t), t)

constraints =
    2*g*m*r*y(t) - 2*T(t)*y(t)^2 - 2*m*r*Dxt(t)^2 -...
    2*m*r*Dyt(t)^2 - 2*T(t)*x(t)^2
    r^2 - y(t)^2 - x(t)^2
    2*Dxt(t)*x(t) + 2*Dyt(t)*y(t)
```

Step 2. ODEs to Function Handles for `ode15s` and `ode23t`

From the output of `reduceDAETToODE`, you have a vector of equations in `ODEs` and a vector of variables in `vars`. To use `ode15s` or `ode23t`, you need two function handles: one representing the mass matrix of the ODE system, and the other representing the vector containing the right sides of

the mass matrix equations. These function handles are the equivalent mass matrix representation of the ODE system where $M(t,y(t))y'(t) = f(t,y(t))$.

Find these function handles by using `massMatrixForm` to get the mass matrix `massM` (M in the equation) and right sides `f`.

```
[massM,f] = massMatrixForm(ODEs,vars)
```

```
massM =
[      -1,          0,          0,          0,          0]
[          0,      -1,          0,          0,          0]
[          0,          0,          0,          m,          0]
[          0,          0,          0,          0,          m]
[-4*T(t)*x(t), 2*g*m*r - 4*T(t)*y(t), -2*x(t)^2 - 2*y(t)^2, -4*m*r*Dxt(t), -4*m*r*Dyt(t)]

f =
      -Dxt(t)
      -Dyt(t)
      (T(t)*x(t))/r
      (T(t)*y(t) - g*m*r)/r
      0
```

The equations in `ODEs` can contain symbolic parameters that are not specified in the vector of variables `vars`. Find these parameters by using `setdiff` on the output of `symvar` from `ODEs` and `vars`.

```
pODEs = symvar(ODEs);
pvars = symvar(vars);
extraParams = setdiff(pODEs, pvars)
```

```
extraParams =
[ g, m, r]
```

The extra parameters that you need to specify are the mass `m`, radius `r`, and gravitational constant `g`.

Convert `massM` and `f` to function handles using `odeFunction`. Specify the extra symbolic parameters as additional inputs to `odeFunction`.

```
massM = odeFunction(massM, vars, m, r, g);
f = odeFunction(f, vars, m, r, g);
```

The rest of the workflow is purely numerical. Set the parameter values and substitute the parameter values in `DAEs` and `constraints`.

```
m = 1;
r = 1;
g = 9.81;
ODEsNumeric = subs(ODEs);
constraintsNumeric = subs(constraints);
```

Create the function handle suitable for input to `ode15s` or `ode23s`.

```
M = @(t, Y) massM(t, Y, m, r, g);
F = @(t, Y) f(t, Y, m, r, g);
```

Step 3. Initial Conditions for `ode15s` and `ode23t`

The solvers require initial values for all variables in the function handle. Find initial values that satisfy the equations by using the MATLAB `decic` function. The `decic` accepts guesses (which might not satisfy the equations) for the initial conditions and tries to find satisfactory initial conditions using

those guesses. `decic` can fail, in which case you must manually supply consistent initial values for your problem.

First, check the variables in `vars`.

```
vars =
    x(t)
    y(t)
    T(t)
    Dxt(t)
    Dyt(t)
```

Here, $Dx(t)$ is the first derivative of $x(t)$, and so on. There are 5 variables in a 5-by-1 vector. Therefore, guesses for initial values of variables and their derivatives must also be 5-by-1 vectors.

Assume the initial angular displacement of the pendulum is 30° or $\pi/6$, and the origin of the coordinates is at the suspension point of the pendulum. Given that we used a radius r of 1, the initial horizontal position $x(t)$ is $r \cdot \sin(\pi/6)$. The initial vertical position $y(t)$ is $-r \cdot \cos(\pi/6)$. Specify these initial values of the variables in the vector `y0est`.

Arbitrarily set the initial values of the remaining variables and their derivatives to 0. These are not good guesses. However, they suffice for this problem. In your problem, if `decic` errors, then provide better guesses and refer to the `decic` page.

```
y0est = [r*sin(pi/6); -r*cos(pi/6); 0; 0; 0];
yp0est = zeros(5,1);
```

Create an option set that contains the mass matrix M of the system and specifies numerical tolerances for the numerical search.

```
opt = odeset('Mass', M, 'RelTol', 10.0^(-7), 'AbsTol', 10.0^(-7));
```

Find initial values consistent with the system of ODEs and with the algebraic constraints by using `decic`. The parameter `[1,0,0,0,1]` in this function call fixes the first and the last element in `y0est`, so that `decic` does not change them during the numerical search. Here, this fixing is necessary to ensure `decic` finds satisfactory initial conditions.

```
[y0, yp0] = decic(ODEsNumeric, vars, constraintsNumeric, 0,...
    y0est, [1,0,0,0,1], yp0est, opt)
```

```
y0 =
    0.5000
   -0.8660
   -8.4957
         0
         0
```

```
yp0 =
         0
         0
         0
   -4.2479
   -2.4525
```

Now create an option set that contains the mass matrix M of the system and the vector `yp0` of consistent initial values for the derivatives. You will use this option set when solving the system.

```
opt = odeset(opt, 'InitialSlope', yp0);
```

Step 4. Solve an ODE System with ode15s or ode23t

Solve the system integrating over the time span $0 \leq t \leq 0.5$. Add the grid lines and the legend to the plot. Use ode23s by replacing ode15s with ode23s.

```
[tSol,ySol] = ode15s(F, [0, 0.5], y0, opt);
plot(tSol,ySol(:,1:origVars),'-o')
```

```
for k = 1:origVars
    S{k} = char(vars(k));
end
```

```
legend(S, 'Location', 'Best')
grid on
```

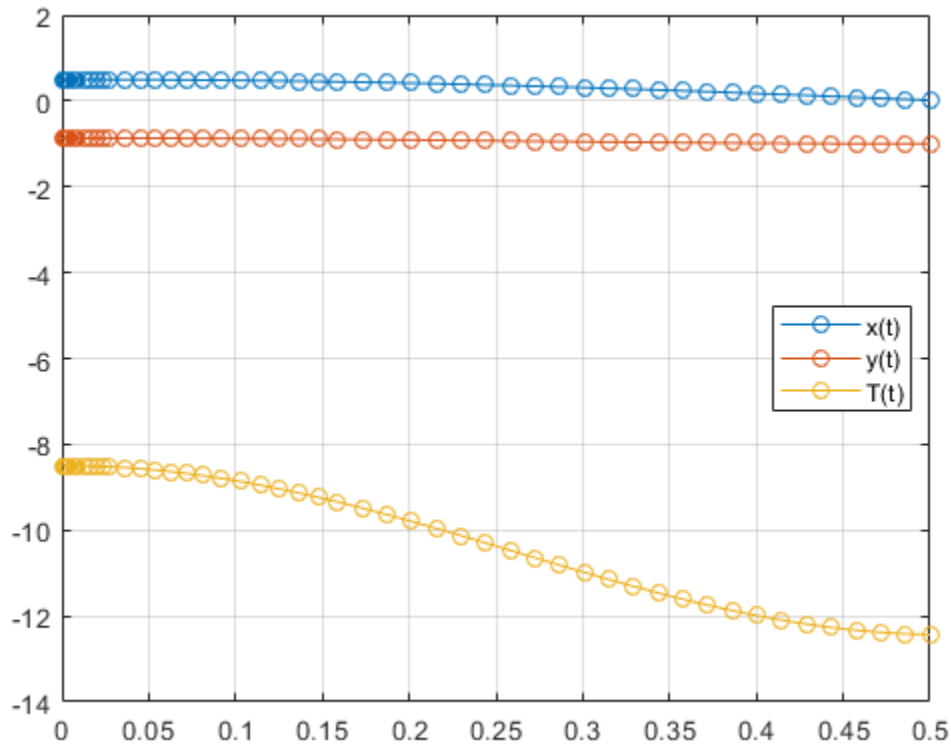

Solve the system for different parameter values by setting the new value and regenerating the function handle and initial conditions.

Set r to 2 and repeat the steps.

```
r = 2;
ODEsNumeric = subs(ODEs);
constraintsNumeric = subs(constraints);
M = @(t, Y) massM(t, Y, m, r, g);
```

```

F = @(t, Y) f(t, Y, m, r, g);

y0est = [r*cos(pi/6); -r*sin(pi/6); 0; 0; 0];
opt = odeset('Mass', M, 'RelTol', 10.0^(-7), 'AbsTol', 10.0^(-7));
[y0, yp0] = decic(ODEsNumeric, vars, constraintsNumeric, 0,...
    y0est, [1,0,0,0,1], yp0est, opt);

opt = odeset(opt, 'InitialSlope', yp0);

Solve the system for the new parameter value.

[tSol,ySol] = ode15s(F, [0, 0.5], y0, opt);
plot(tSol,ySol(:,1:origVars),'-o')

for k = 1:origVars
    S{k} = char(vars(k));
end

legend(S, 'Location', 'Best')
grid on

```

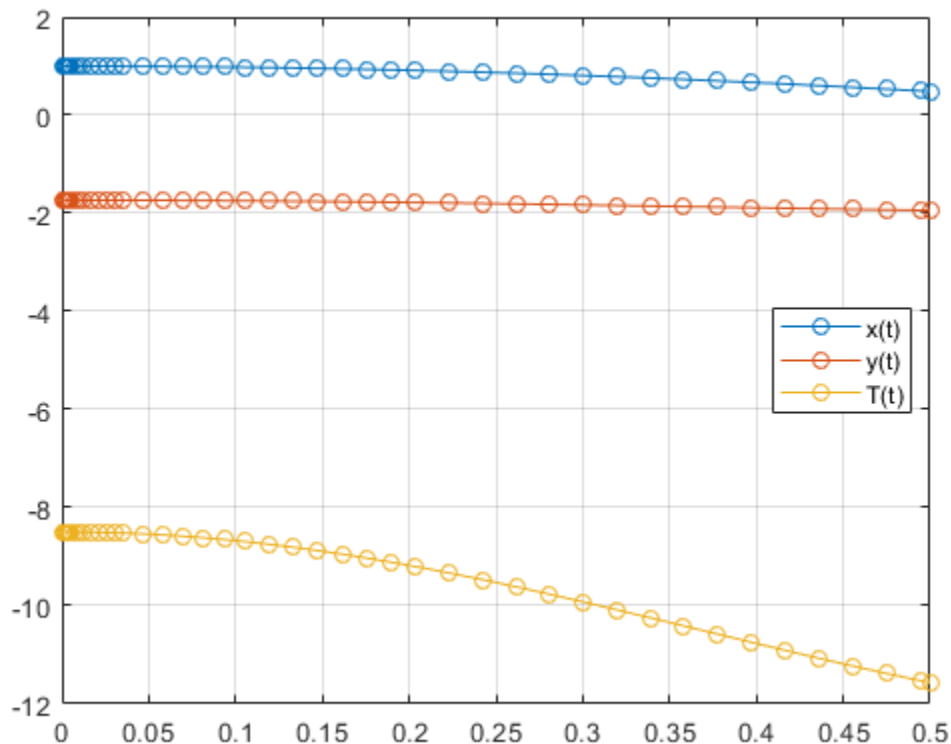

See Also

[daeFunction](#) | [decic](#) | [findDecoupledBlocks](#) | [incidenceMatrix](#) | [isLowIndexDAE](#) | [massMatrixForm](#) | [odeFunction](#) | [reduceDAEIndex](#) | [reduceDAEToODE](#) | [reduceDifferentialOrder](#) | [reduceRedundancies](#)

Related Examples

- “Solve Differential Algebraic Equations (DAEs)” on page 2-194
- “Solve DAEs Using Mass Matrix Solvers” on page 2-209

Solve DAEs Using Mass Matrix Solvers

Solve differential algebraic equations by using one of the mass matrix solvers available in MATLAB. To use this workflow, first complete steps 1, 2, and 3 from “Solve Differential Algebraic Equations (DAEs)” on page 2-194. Then, use a mass matrix solver instead of `ode15i`.

This example demonstrates the use of `ode15s` or `ode23t`. For details on the other solvers, see “Choose an ODE Solver” (MATLAB) and adapt the workflow on this page.

In this section...

“Step 1. Convert DAEs to Function Handles” on page 2-209

“Step 2. Find Initial Conditions” on page 2-210

“Step 3. Solve DAE System” on page 2-211

Step 1. Convert DAEs to Function Handles

From the output of `reduceDAEIndex`, you have a vector of equations `DAEs` and a vector of variables `DAEvars`. To use `ode15s` or `ode23t`, you need two function handles: one representing the mass matrix of a DAE system, and the other representing the right sides of the mass matrix equations. These function handles form the equivalent mass matrix representation of the ODE system where $M(t,y(t))y'(t) = f(t,y(t))$.

Find these function handles by using `massMatrixForm` to get the mass matrix `M` and the right sides `F`.

```
[M, f] = massMatrixForm(DAEs, DAEvars)
```

```
M =
[ 0, 0, 0, 0, 0, 0, 0]
[ 0, 0, 0, 0, 0, 0, 0]
[ 0, 0, 0, 0, 0, 0, 0]
[ 0, 0, 0, 0, 0, 0, 0]
[ 0, 0, 0, 0, 0, 0, 0]
[ 0, 0, 0, 0, -1, 0, 0]
[ 0, -1, 0, 0, 0, 0, 0]

f =
(T(t)*x(t) - m*r*Dxtt(t))/r
-(g*m*r - T(t)*y(t) + m*r*Dytt(t))/r
r^2 - y(t)^2 - x(t)^2
- 2*Dxt(t)*x(t) - 2*Dyt(t)*y(t)
- 2*Dxtt(t)*x(t) - 2*Dytt(t)*y(t) - 2*Dxt(t)^2 - 2*Dyt(t)^2
-Dytt(t)
-Dyt(t)
```

The equations in DAEs can contain symbolic parameters that are not specified in the vector of variables `DAEvars`. Find these parameters by using `setdiff` on the output of `symvar` from `DAEs` and `DAEvars`.

```
pDAEs = symvar(DAEs);
pDAEvars = symvar(DAEvars);
extraParams = setdiff(pDAEs, pDAEvars)
```

```
extraParams =
[ g, m, r]
```

The mass matrix M does not have these extra parameters. Therefore, convert M directly to a function handle by using `odeFunction`.

```
M = odeFunction(M, DAEvars);
```

Convert f to a function handle. Specify the extra parameters as additional inputs to `odeFunction`.

```
f = odeFunction(f, DAEvars, g, m, r);
```

The rest of the workflow is purely numerical. Set parameter values and create the function handle.

```
g = 9.81;
m = 1;
r = 1;
F = @(t, Y) f(t, Y, g, m, r);
```

Step 2. Find Initial Conditions

The solvers require initial values for all variables in the function handle. Find initial values that satisfy the equations by using the MATLAB `decic` function. The `decic` accepts guesses (which might not satisfy the equations) for the initial conditions, and tries to find satisfactory initial conditions using those guesses. `decic` can fail, in which case you must manually supply consistent initial values for your problem.

First, check the variables in `DAEvars`.

```
DAEvars
```

```
DAEvars =
  x(t)
  y(t)
  T(t)
  Dxt(t)
  Dyt(t)
  Dytt(t)
  Dxtt(t)
```

Here, $Dxt(t)$ is the first derivative of $x(t)$, $Dytt(t)$ is the second derivative of $y(t)$, and so on. There are 7 variables in a 7-by-1 vector. Thus, guesses for initial values of variables and their derivatives must also be 7-by-1 vectors.

Assume the initial angular displacement of the pendulum is 30° or $\pi/6$, and the origin of the coordinates is at the suspension point of the pendulum. Given that we used a radius r of 1, the initial horizontal position $x(t)$ is $r*\sin(\pi/6)$. The initial vertical position $y(t)$ is $-r*\cos(\pi/6)$. Specify these initial values of the variables in the vector `y0est`.

Arbitrarily set the initial values of the remaining variables and their derivatives to 0. These are not good guesses. However, they suffice for our problem. In your problem, if `decic` errors, then provide better guesses and refer to the `decic` page.

```
y0est = [r*sin(pi/6); -r*cos(pi/6); 0; 0; 0; 0; 0];
yp0est = zeros(7,1);
```

Create an option set that contains the mass matrix M and initial guesses $yp0est$, and specifies numerical tolerances for the numerical search.

```
opt = odeset('Mass', M, 'InitialSlope', yp0est,...
            'RelTol', 10.0^(-7), 'AbsTol', 10.0^(-7));
```

Find consistent initial values for the variables and their derivatives by using the MATLAB `decic` function. The first argument of `decic` must be a function handle describing the DAE as $f(t, y, yp) = f(t, y, y') = 0$. In terms of M and F , this means $f(t, y, yp) = M(t, y)*yp - F(t, y)$.

```
implicitDAE = @(t,y,yp) M(t,y)*yp - F(t,y);
[y0, yp0] = decic(implicitDAE, 0, y0est, [], yp0est, [], opt)
```

```
y0 =
    0.4771
   -0.8788
   -8.6214
         0
    0.0000
   -2.2333
   -4.1135
```

```
yp0 =
         0
    0.0000
         0
         0
   -2.2333
         0
         0
```

Now create an option set that contains the mass matrix M of the system and the vector $yp0$ of consistent initial values for the derivatives. You will use this option set when solving the system.

```
opt = odeset(opt, 'InitialSlope', yp0);
```

Step 3. Solve DAE System

Solve the system integrating over the time span $0 \leq t \leq 0.5$. Add the grid lines and the legend to the plot. The code uses `ode15s`. Instead, you can use `ode23s` by replacing `ode15s` with `ode23s`.

```
[tSol,ySol] = ode15s(F, [0, 0.5], y0, opt);
plot(tSol,ySol(:,1:origVars),'-o')
```

```
for k = 1:origVars
    S{k} = char(DAEvars(k));
end
```

```
legend(S, 'Location', 'Best')
grid on
```

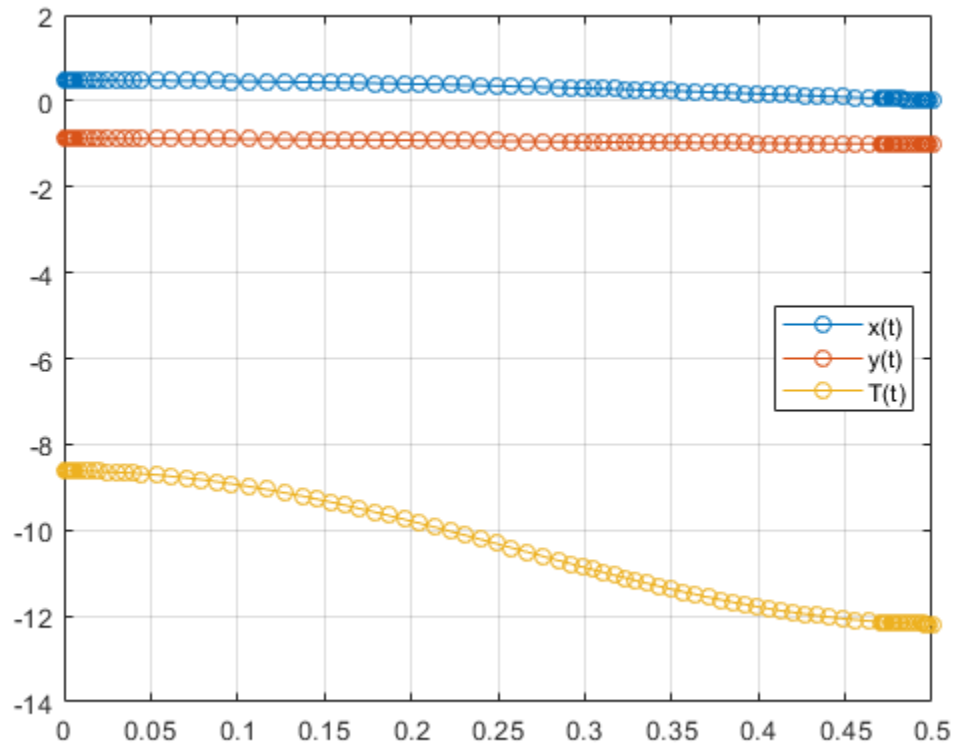

Solve the system for different parameter values by setting the new value and regenerating the function handle and initial conditions.

Set r to 2 and regenerate the function handle and initial conditions.

```
r = 2;
F = @(t, Y) f(t, Y, g, m, r);
y0est = [r*sin(pi/6); -r*cos(pi/6); 0; 0; 0; 0; 0];
implicitDAE = @(t,y,yp) M(t,y)*yp - F(t,y);
[y0, yp0] = decic(implicitDAE, 0, y0est, [], yp0est, [], opt);
```

```
opt = odeset(opt, 'InitialSlope', yp0);
```

Solve the system for the new parameter value.

```
[tSol,ySol] = ode15s(F, [0, 0.5], y0, opt);
plot(tSol,ySol(:,1:origVars),'-o')
```

```
for k = 1:origVars
    S{k} = char(DAEvars(k));
end
```

```
legend(S, 'Location', 'Best')
grid on
```

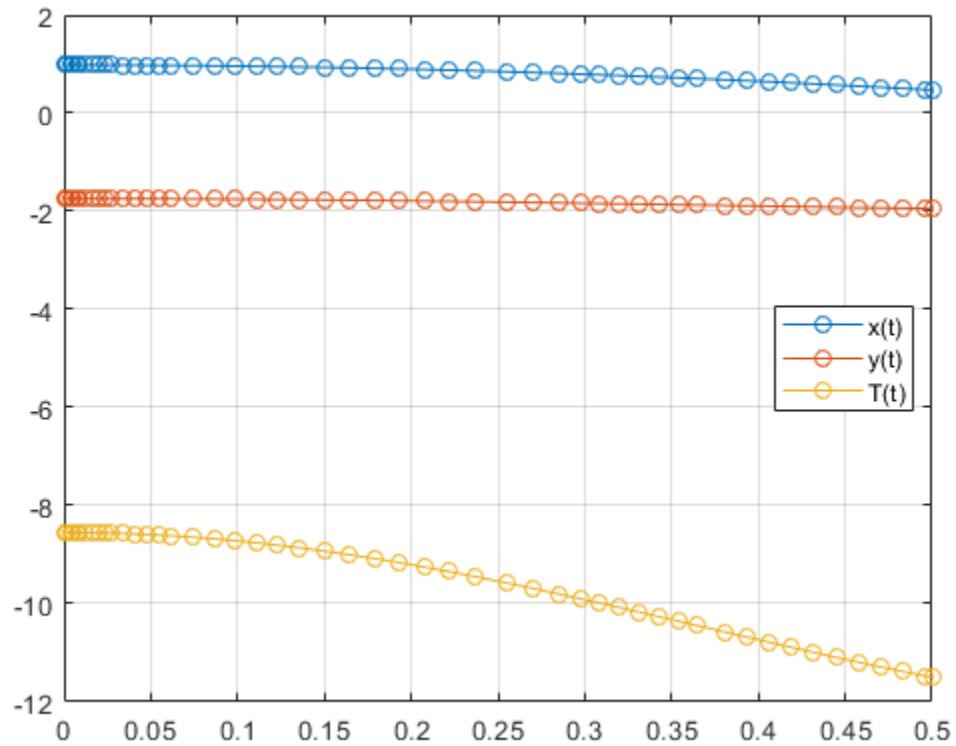
See Also

Related Examples

- “Solve Differential Algebraic Equations (DAEs)” on page 2-194
- “Solve Semilinear DAE System” on page 2-203

Fourier and Inverse Fourier Transforms

This page shows the workflow for Fourier and inverse Fourier transforms in Symbolic Math Toolbox. For simple examples, see `fourier` and `ifourier`. Here, the workflow for Fourier transforms is demonstrated by calculating the deflection of a beam due to a force. The associated differential equation is solved by the Fourier transform.

Fourier Transform Definition

The Fourier transform of $f(x)$ with respect to x at w is

$$F(w) = \int_{-\infty}^{\infty} f(x)e^{-iwx}dx.$$

The inverse Fourier transform is

$$f(x) = \frac{1}{2\pi} \int_{-\infty}^{\infty} F(w)e^{iwx}dw.$$

Concept: Using Symbolic Workflows

Symbolic workflows keep calculations in the natural symbolic form instead of numeric form. This approach helps you understand the properties of your solution and use exact symbolic values. You substitute numbers in place of symbolic variables only when you require a numeric result or you cannot continue symbolically. For details, see “Choose Numeric or Symbolic Arithmetic” on page 2-124. Typically, the steps are:

- 1 Declare equations.
- 2 Solve equations.
- 3 Substitute values.
- 4 Plot results.
- 5 Analyze results.

Calculate Beam Deflection Using Fourier Transform

Define Equations

Fourier transform can be used to solve ordinary and partial differential equations. For example, you can model the deflection of an infinitely long beam resting on an elastic foundation under a point force. A corresponding real-world example is railway tracks on a foundation. The railway tracks are the infinitely long beam while the foundation is elastic.

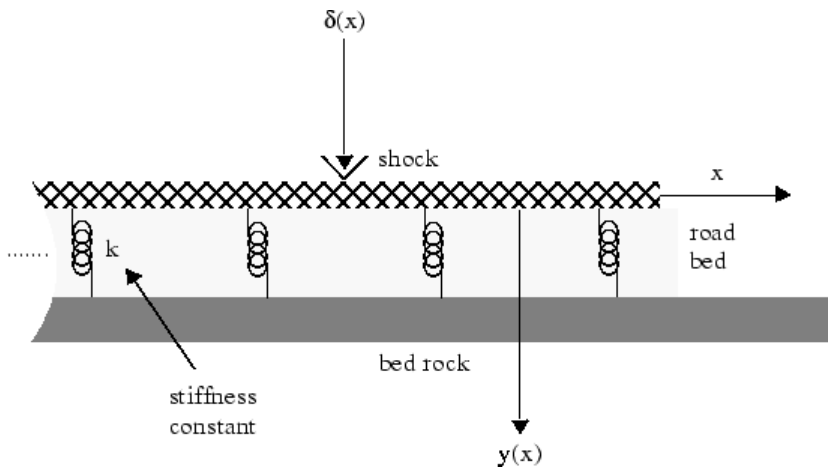

Let

- E be the elasticity of the beam (or railway track).
- I be the second moment of area of the cross-section of the beam.
- k be the spring stiffness of the foundation.

The differential equation is

$$\frac{d^4 y}{dx^4} + \frac{k}{EI} y = \frac{1}{EI} \delta(x), \quad -\infty < x < \infty.$$

Define the function $y(x)$ and the variables. Assume E , I , and k are positive.

```
syms Y(x) w E I k f
assume([E I k] > 0)
```

Assign units to the variables by using `symunit`.

```
u = symunit;
Eu = E*u.Pa;      % Pascal
Iu = I*u.m^4;     % meter^4
ku = k*u.N/u.m^2; % Newton/meter^2
X = x*u.m;
F = f*u.N/u.m;
```

Define the differential equation.

```
eqn = diff(Y,X,4) + ku/(Eu*Iu)*Y == F/(Eu*Iu)
```

```
eqn(x) =
diff(Y(x), x, x, x, x)*(1/[m]^4) + ((k*Y(x))/(E*I))*([N]/([Pa]*[m]^6)) == ...
(f/(E*I))*([N]/([Pa]*[m]^5))
```

Represent the force f by the Dirac delta function $\delta(x)$.

```
eqn = subs(eqn,f,dirac(x))
```

```
eqn(x) =
diff(Y(x), x, x, x, x)*(1/[m]^4) + ((k*Y(x))/(E*I))*([N]/([Pa]*[m]^6)) == ...
(dirac(x)/(E*I))*([N]/([Pa]*[m]^5))
```

Solve Equations

Calculate the Fourier transform of eqn by using `fourier` on both sides of eqn. The Fourier transform converts differentiation into exponents of w .

```
eqnFT = fourier(lhs(eqn)) == fourier(rhs(eqn))

eqnFT =
w^4*fourier(Y(x), x, w)*(1/[m]^4) + ((k*fourier(Y(x), x, w))/(E*I))*([N]/([Pa]*[m]^6)) ...
    == (1/(E*I))*([N]/([Pa]*[m]^5))
```

Isolate `fourier(Y(x),x,w)` in the equation.

```
eqnFT = isolate(eqnFT, fourier(Y(x),x,w))

eqnFT =
fourier(Y(x), x, w) == (1/(E*I*w^4*[Pa]*[m]^2 + k*[N]))*[N]*[m]
```

Calculate $Y(x)$ by calculating the inverse Fourier transform of the right side. Simplify the result.

```
YSol = ifourier(rhs(eqnFT));
YSol = simplify(YSol)

YSol =
((exp(-(2^(1/2)*k^(1/4)*abs(x))/(2*E^(1/4)*I^(1/4))))*sin((2*2^(1/2)*k^(1/4)*abs(x) + ...
    pi*E^(1/4)*I^(1/4))/(4*E^(1/4)*I^(1/4))))/(2*E^(1/4)*I^(1/4)*k^(3/4))*[m]
```

Check that `YSol` has the correct dimensions by substituting `YSol` into `eqn` and using the `checkUnits` function. `checkUnits` returns logical 1 (true), meaning `eqn` now has compatible units of the same physical dimensions.

```
checkUnits(subs(eqn,Y,YSol))
```

```
ans =
    struct with fields:
        Consistent: 1
        Compatible: 1
```

Separate the expression from the units by using `separateUnits`.

```
YSol = separateUnits(YSol)

YSol =
(exp(-(2^(1/2)*k^(1/4)*abs(x))/(2*E^(1/4)*I^(1/4))))*sin((2*2^(1/2)*k^(1/4)*abs(x) + ...
    pi*E^(1/4)*I^(1/4))/(4*E^(1/4)*I^(1/4))))/(2*E^(1/4)*I^(1/4)*k^(3/4))
```

Substitute Values

Use the values $E = 10^6$ Pa, $I = 10^{-3}$ m⁴, and $k = 10^6$ N/m². Substitute these values into `YSol` and convert to floating point by using `vpa` with 16 digits of accuracy.

```
values = [1e6 1e-3 1e5];
YSol = subs(YSol,[E I k],values);
YSol = vpa(YSol,16)

YSol =
0.0000158113883008419*exp(-2.23606797749979*abs(x))*sin(2.23606797749979*abs(x) + ...
    0.7853981633974483)
```

Plot Results

Plot the result by using `fplot`.

```
fplot(YSol)
xlabel('x')
ylabel('Deflection y(x)')
```

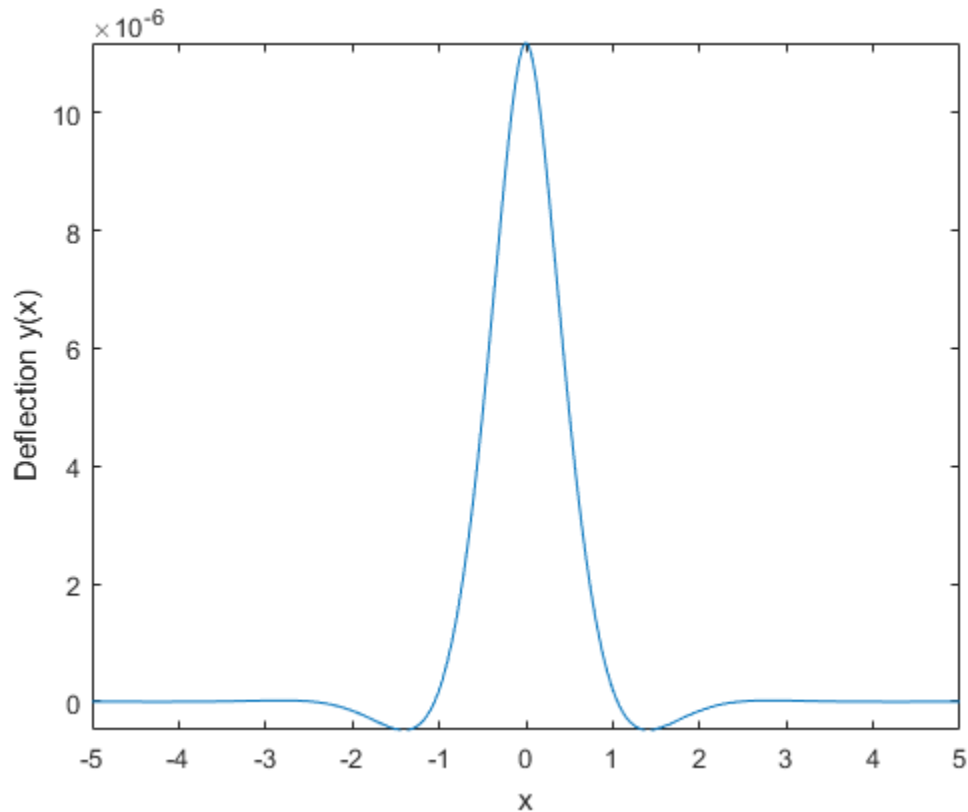

Analyze Results

The plot shows that the deflection of a beam due to a point force is highly localized. The deflection is greatest at the point of impact and then decreases quickly. The symbolic result enables you to analyze the properties of the result, which is not possible with numeric results.

Notice that `YSol` is a product of terms. The term with `sin` shows that the response is vibrating oscillatory behavior. The term with `exp` shows that the oscillatory behavior is quickly damped by the exponential decay as the distance from the point of impact increases.

Solve Differential Equations Using Laplace Transform

Solve differential equations by using Laplace transforms in Symbolic Math Toolbox with this workflow. For simple examples on the Laplace transform, see `laplace` and `ilaplace`.

Definition: Laplace Transform

The Laplace transform of a function $f(t)$ is

$$F(s) = \int_0^{\infty} f(t)e^{-ts}dt.$$

Concept: Using Symbolic Workflows

Symbolic workflows keep calculations in the natural symbolic form instead of numeric form. This approach helps you understand the properties of your solution and use exact symbolic values. You substitute numbers in place of symbolic variables only when you require a numeric result or you cannot continue symbolically. For details, see “Choose Numeric or Symbolic Arithmetic” on page 2-124. Typically, the steps are:

- 1 Declare equations.
- 2 Solve equations.
- 3 Substitute values.
- 4 Plot results.
- 5 Analyze results.

Workflow: Solve RLC Circuit Using Laplace Transform

Declare Equations

You can use the Laplace transform to solve differential equations with initial conditions. For example, you can solve resistance-inductor-capacitor (RLC) circuits, such as this circuit.

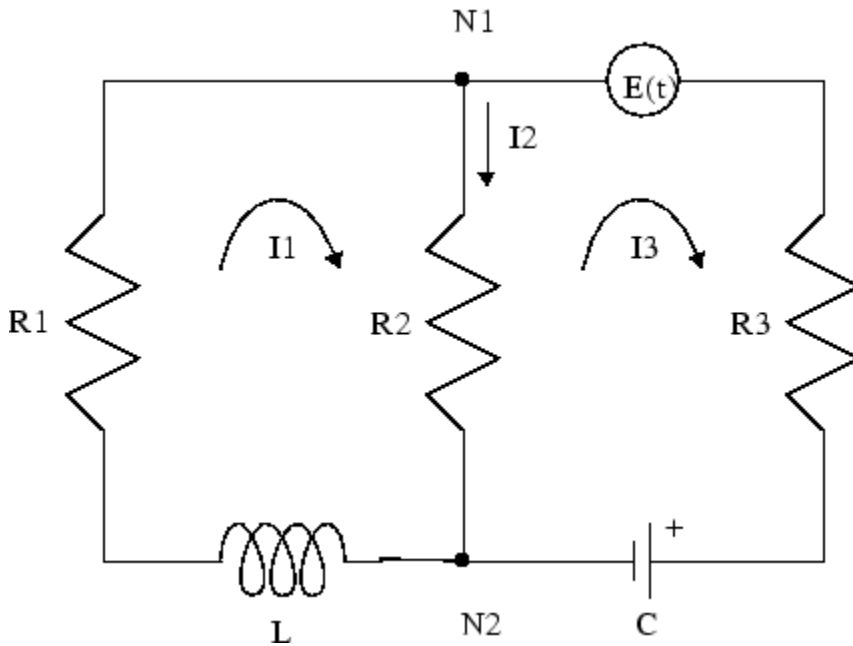

- Resistances in ohm: R_1, R_2, R_3
- Currents in ampere: I_1, I_2, I_3
- Inductance in henry: L
- Capacitance in farad: C
- Electromotive force in volts: $E(t)$
- Charge in coulomb: $Q(t)$

Apply Kirchoff's voltage and current laws to get the differential equations for the RLC circuit.

$$\frac{dI_1}{dt} + \frac{R_2}{L} \frac{dQ}{dt} = \frac{R_2 - R_1}{L} I_1.$$

$$\frac{dQ}{dt} = \frac{1}{R_3 + R_2} \left(E(t) - \frac{1}{C} Q(t) \right) + \frac{R_2}{R_3 + R_2} I_1.$$

Declare the variables. Because the physical quantities have positive values, set the corresponding assumptions on the variables. Let $E(t)$ be an alternating voltage of 1 V.

```
syms L C I1(t) Q(t) s
R = sym('R%d',[1 3]);
assume([t L C R] > 0)
E(t) = 1*sin(t);           % Voltage = 1 V
```

Declare the differential equations.

```
dI1 = diff(I1,t);
dQ = diff(Q,t);
eqn1 = dI1 + (R(2)/L)*dQ == (R(2)-R(1))/L*I1
eqn2 = dQ == (1/(R(2)+R(3)))*(E-Q/C) + R(2)/(R(2)+R(3))*I1

eqn1(t) =
diff(I1(t), t) + (R2*diff(Q(t), t))/L == -(I1(t)*(R1 - R2))/L
```

```
eqn2(t) =
diff(Q(t), t) == (sin(t) - Q(t)/C)/(R2 + R3) + (R2*I1(t))/(R2 + R3)
```

Assume that the initial current and charge, I_0 and Q_0 , are both 0. Declare these initial conditions.

```
cond1 = I1(0) == 0
cond2 = Q(0) == 0
```

```
cond1 =
I1(0) == 0
cond2 =
Q(0) == 0
```

Solve Equations

Compute the Laplace transform of eqn1 and eqn2.

```
eqn1LT = laplace(eqn1,t,s)
eqn2LT = laplace(eqn2,t,s)
```

```
eqn1LT =
s*laplace(I1(t), t, s) - I1(0) - (R2*(Q(0) - s*laplace(Q(t), t, s)))/L == ...
-((R1 - R2)*laplace(I1(t), t, s))/L
eqn2LT =
s*laplace(Q(t), t, s) - Q(0) == (R2*laplace(I1(t), t, s))/(R2 + R3) + ...
(C/(s^2 + 1) - laplace(Q(t), t, s))/(C*(R2 + R3))
```

The function `solve` solves only for symbolic variables. Therefore, to use `solve`, first substitute `laplace(I1(t), t, s)` and `laplace(Q(t), t, s)` with the variables `I1_LT` and `Q_LT`.

```
syms I1_LT Q_LT
eqn1LT = subs(eqn1LT, [laplace(I1,t,s) laplace(Q,t,s)], [I1_LT Q_LT])
```

```
eqn1LT =
I1_LT*s - I1(0) - (R2*(Q(0) - Q_LT*s))/L == -(I1_LT*(R1 - R2))/L
```

```
eqn2LT = subs(eqn2LT, [laplace(I1,t,s) laplace(Q,t,s)], [I1_LT Q_LT])
```

```
eqn2LT =
Q_LT*s - Q(0) == (I1_LT*R2)/(R2 + R3) - (Q_LT - C/(s^2 + 1))/(C*(R2 + R3))
```

Solve the equations for `I1_LT` and `Q_LT`.

```
eqns = [eqn1LT eqn2LT];
vars = [I1_LT Q_LT];
[I1_LT, Q_LT] = solve(eqns, vars)
```

```
I1_LT =
(R2*Q(0) + L*I1(0) - C*R2*s + L*s^2*I1(0) + R2*s^2*Q(0) + C*L*R2*s^3*I1(0) + ...
C*L*R3*s^3*I1(0) + C*L*R2*s*I1(0) + C*L*R3*s*I1(0))/((s^2 + 1)*(R1 - R2 + L*s + ...
C*L*R2*s^2 + C*L*R3*s^2 + C*R1*R2*s + C*R1*R3*s - C*R2*R3*s))
Q_LT =
(C*(R1 - R2 + L*s + L*R2*I1(0) + R1*R2*Q(0) + R1*R3*Q(0) - R2*R3*Q(0) + ...
L*R2*s^2*I1(0) + L*R2*s^3*Q(0) + L*R3*s^3*Q(0) + R1*R2*s^2*Q(0) + R1*R3*s^2*Q(0) - ...
R2*R3*s^2*Q(0) + L*R2*s*Q(0) + ...
L*R3*s*Q(0))/((s^2 + 1)*(R1 - R2 + L*s + C*L*R2*s^2 + C*L*R3*s^2 + ...
C*R1*R2*s + C*R1*R3*s - C*R2*R3*s))
```

Calculate I_1 and Q by computing the inverse Laplace transform of `I1_LT` and `Q_LT`. Simplify the result. Suppress the output because it is long.

```

Ilsol = ilaplace(I1_LT,s,t);
Qsol = ilaplace(Q_LT,s,t);
Ilsol = simplify(Ilsol);
Qsol = simplify(Qsol);

```

Substitute Values

Before plotting the result, substitute symbolic variables by the numeric values of the circuit elements. Let $R1 = 4 \Omega$, $R2 = 2 \Omega$, $R3 = 3 \Omega$, $C = 1/4 \text{ F}$, $L = 1.6 \text{ H}$, $I_1(0) = 15 \text{ A}$, and $Q(0) = 2 \text{ C}$.

```

vars = [R L C I1(0) Q(0)];
values = [4 2 3 1.6 1/4 15 2];
Ilsol = subs(Ilsol,vars,values)
Qsol = subs(Qsol,vars,values)

```

```

Ilsol =
15*exp(-(51*t)/40)*(cosh((1001^(1/2)*t)/40) - ...
(293*1001^(1/2)*sinh((1001^(1/2)*t)/40))/21879) - (5*sin(t))/51
Qsol =
(4*sin(t))/51 - (5*cos(t))/51 + (107*exp(-(51*t)/40)*(cosh((1001^(1/2)*t)/40) + ...
(2039*1001^(1/2)*sinh((1001^(1/2)*t)/40))/15301))/51

```

Plot Results

Plot the current `Ilsol` and charge `Qsol`. Show both the transient and steady state behavior by using two different time intervals: $0 \leq t \leq 10$ and $5 \leq t \leq 25$.

```

subplot(2,2,1)
fplot(Ilsol,[0 10])
title('Current')
ylabel('I1(t)')
xlabel('t')

subplot(2,2,2)
fplot(Qsol,[0 10])
title('Charge')
ylabel('Q(t)')
xlabel('t')

subplot(2,2,3)
fplot(Ilsol,[5 25])
title('Current')
ylabel('I1(t)')
xlabel('t')
text(7,0.25,'Transient')
text(16,0.125,'Steady State')

subplot(2,2,4)
fplot(Qsol,[5 25])
title('Charge')
ylabel('Q(t)')
xlabel('t')
text(7,0.25,'Transient')
text(15,0.16,'Steady State')

```

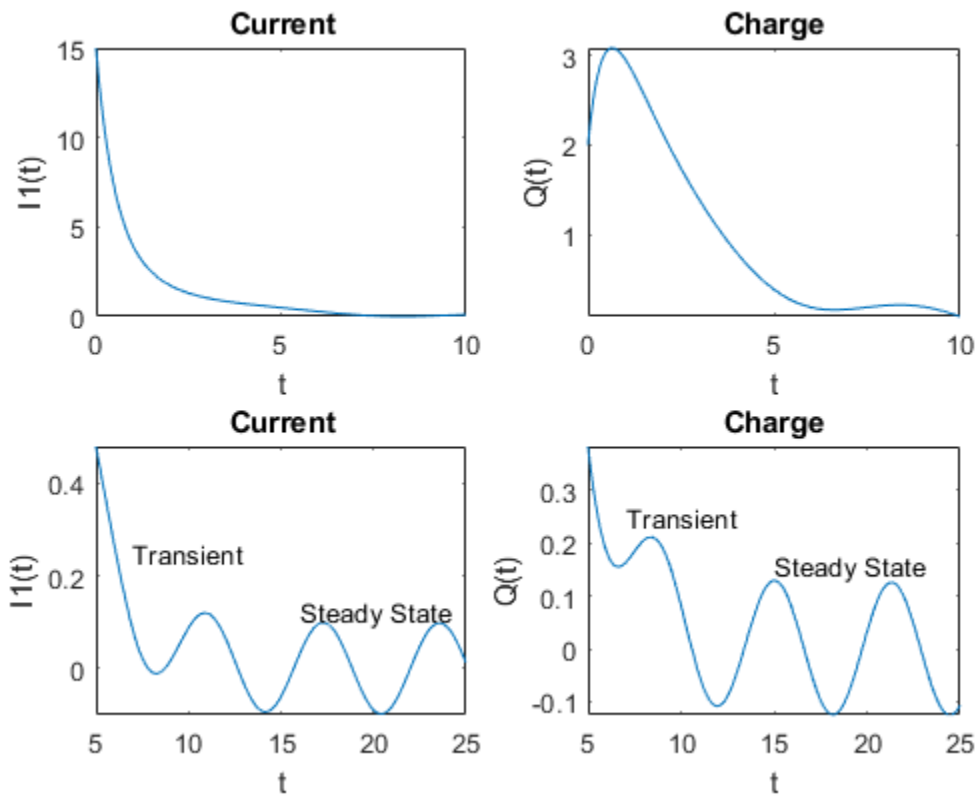

Analyze Results

Initially, the current and charge decrease exponentially. However, over the long term, they are oscillatory. These behaviors are called "transient" and "steady state", respectively. With the symbolic result, you can analyze the result's properties, which is not possible with numeric results.

Visually inspect $I1sol$ and $Qsol$. They are a sum of terms. Find the terms by using `children`. Then, find the contributions of the terms by plotting them over $[0 \ 15]$. The plots show the transient and steady state terms.

```
I1terms = children(I1sol);
Qterms = children(Qsol);
```

```
subplot(1,2,1)
fplot(I1terms,[0 15])
ylim([-2 2])
title('Current terms')
```

```
subplot(1,2,2)
fplot(Qterms,[0 15])
ylim([-2 2])
title('Charge terms')
```

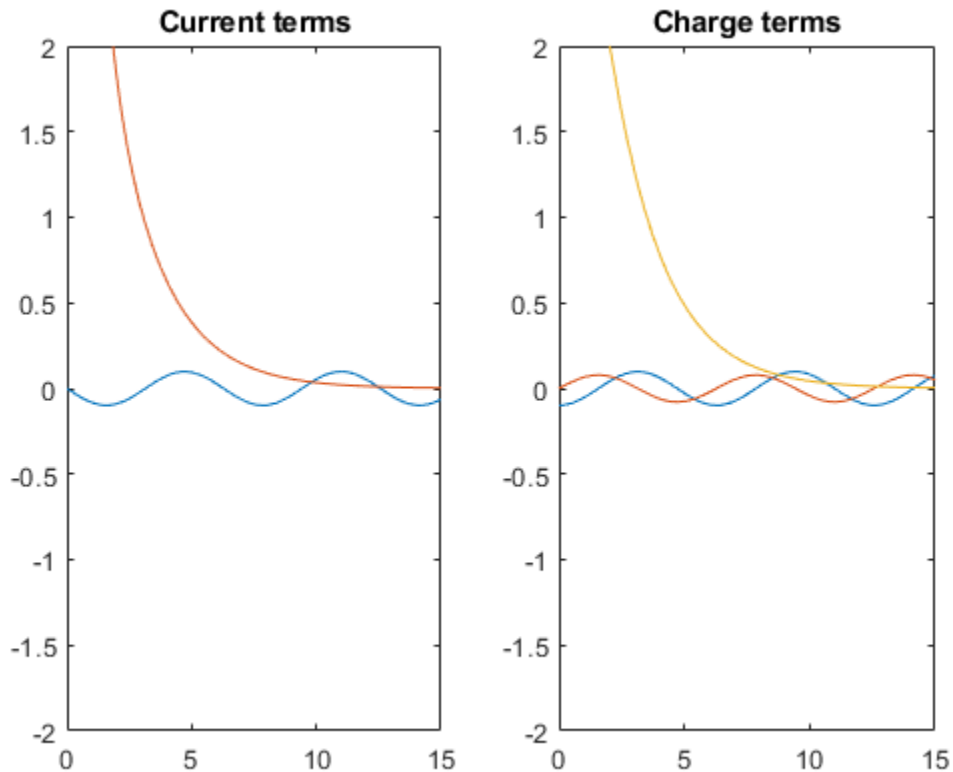

The plots show that I_{sol} has a transient and steady state term, while Q_{sol} has a transient and two steady state terms. From visual inspection, notice I_{sol} and Q_{sol} have a term containing the \exp function. Assume that this term causes the transient exponential decay. Separate the transient and steady state terms in I_{sol} and Q_{sol} by checking terms for \exp using `has`.

```
Iltransient = Ifterms(has(Ifterms, 'exp'))
Ilsteadystate = Ifterms(~has(Ifterms, 'exp'))
```

```
Iltransient =
15*exp(-(51*t)/40)*(cosh((1001^(1/2)*t)/40) - (293*1001^(1/2)*sinh((1001^(1/2)*t)/40))/21879)
Ilsteadystate =
-(5*sin(t))/51
```

Similarly, separate Q_{sol} into transient and steady state terms. This result demonstrates how symbolic calculations help you analyze your problem.

```
Qtransient = Qterms(has(Qterms, 'exp'))
Qsteadystate = Qterms(~has(Qterms, 'exp'))
```

```
Qtransient =
(107*exp(-(51*t)/40)*(cosh((1001^(1/2)*t)/40) + (2039*1001^(1/2)*sinh((1001^(1/2)*t)/40))/15301))/51
Qsteadystate =
[ -(5*cos(t))/51, (4*sin(t))/51]
```

Solve Difference Equations Using Z-Transform

Solve difference equations by using Z-transforms in Symbolic Math Toolbox with this workflow. For simple examples on the Z-transform, see `ztrans` and `iztrans`.

Definition: Z-transform

The Z-transform of a function $f(n)$ is defined as

$$F(z) = \sum_{n=0}^{\infty} \frac{f(n)}{z^n}.$$

Concept: Using Symbolic Workflows

Symbolic workflows keep calculations in the natural symbolic form instead of numeric form. This approach helps you understand the properties of your solution and use exact symbolic values. You substitute numbers in place of symbolic variables only when you require a numeric result or you cannot continue symbolically. For details, see “Choose Numeric or Symbolic Arithmetic” on page 2-124. Typically, the steps are:

- 1 Declare equations.
- 2 Solve equations.
- 3 Substitute values.
- 4 Plot results.
- 5 Analyze results.

Workflow: Solve "Rabbit Growth" Problem Using Z-Transform

Declare Equations

You can use the Z-transform to solve difference equations, such as the well-known "Rabbit Growth" problem. If a pair of rabbits matures in one year, and then produces another pair of rabbits every year, the rabbit population $p(n)$ at year n is described by this difference equation.

$$p(n+2) = p(n+1) + p(n).$$

Declare the equation as an expression assuming the right side is 0. Because n represents years, assume that n is a positive integer. This assumption simplifies the results.

```
syms p(n) z
assume(n>=0 & in(n,'integer'))
f = p(n+2) - p(n+1) - p(n)

f =
p(n + 2) - p(n + 1) - p(n)
```

Solve Equations

Find the Z-transform of the equation.

```
fZT = ztrans(f,n,z)
```

```
fZT =
z*p(0) - z*ztrans(p(n), n, z) - z*p(1) + z^2*ztrans(p(n), n, z) - ...
      z^2*p(0) - ztrans(p(n), n, z)
```

The function `solve` solves only for symbolic variables. Therefore, to use `solve`, first substitute `ztrans(p(n), n, z)` with the variables `pZT`.

```
syms pZT
fZT = subs(fZT, ztrans(p(n), n, z), pZT)

fZT =
z*p(0) - pZT - z*p(1) - pZT*z - z^2*p(0) + pZT*z^2
```

Solve for `pZT`.

```
pZT = solve(fZT, pZT)

pZT =
-(z*p(1) - z*p(0) + z^2*p(0))/(- z^2 + z + 1)
```

Calculate $p(n)$ by computing the inverse Z-transform of `pZT`. Simplify the result.

```
pSol = iztrans(pZT, z, n);
pSol = simplify(pSol)

pSol =
2*(-1)^(n/2)*cos(n*(pi/2 + asinh(1/2)*1i))*p(1) + ...
      (2^(2 - n)*5^(1/2)*(5^(1/2) + 1)^(n - 1)*(p(0)/2 - p(1)))/5 - ...
      (2*2^(1 - n)*5^(1/2)*(1 - 5^(1/2))^(n - 1)*(p(0)/2 - p(1)))/5
```

Substitute Values

To plot the result, first substitute the values of the initial conditions. Let $p(0)$ and $p(1)$ be 1 and 2, respectively.

```
pSol = subs(pSol, [p(0) p(1)], [1 2])

pSol =
4*(-1)^(n/2)*cos(n*(pi/2 + asinh(1/2)*1i)) - (3*2^(2 - n)*5^(1/2)* ...
      (5^(1/2) + 1)^(n - 1))/10 + (3*2^(1 - n)*5^(1/2)*(1 - 5^(1/2))^(n - 1))/5
```

Plot Results

Show the growth in rabbit population over time by plotting `pSol`.

```
nValues = 1:10;
pSolValues = subs(pSol, n, nValues);
pSolValues = double(pSolValues);
pSolValues = real(pSolValues);
stem(nValues, pSolValues)
title('Rabbit Population')
xlabel('Years (n)')
ylabel('Population p(n)')
grid on
```

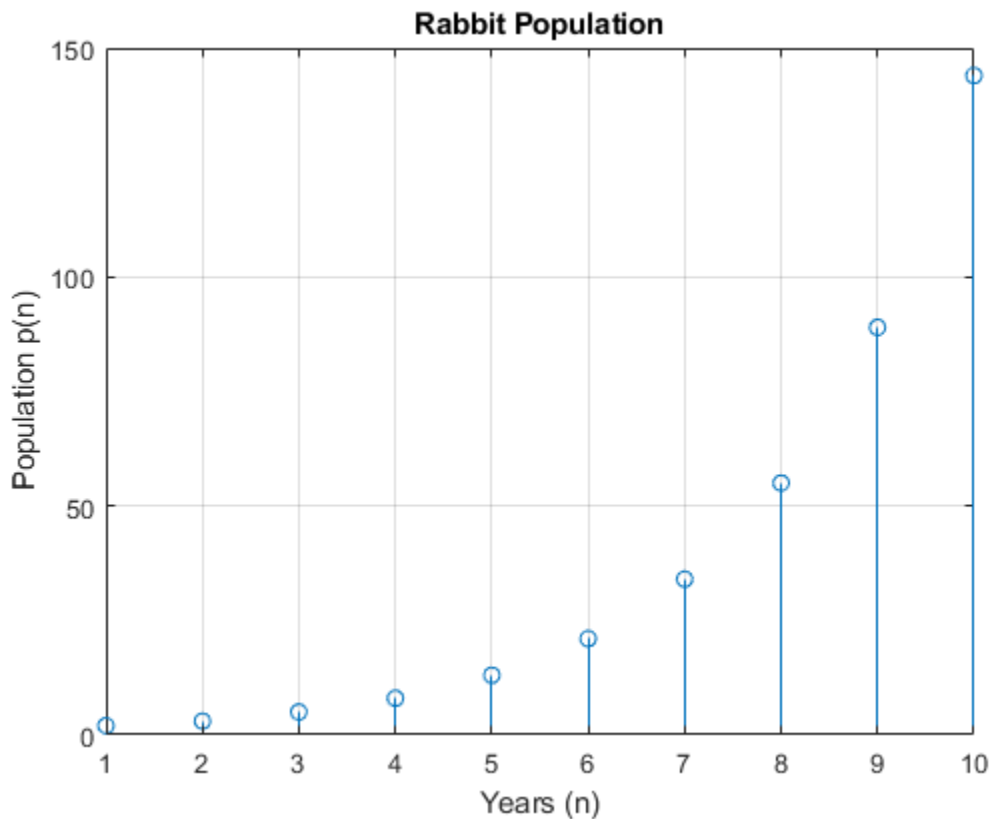

Analyze Results

The plot shows that the solution appears to increase exponentially. However, because the solution `pSol` contains many terms, finding the terms that produce this behavior requires analysis.

Because all the functions in `pSol` can be expressed in terms of `exp`, rewrite `pSol` to `exp`. Simplify the result by using `simplify` with 80 additional simplification steps. Now, you can analyze `pSol`.

```
pSol = rewrite(pSol,'exp');
pSol = simplify(pSol,'Steps',80)
```

```
pSol =
(2*2^n)/(- 5^(1/2) - 1)^n - (3*5^(1/2)*(1/2 - 5^(1/2)/2)^n)/10 + ...
(3*5^(1/2)*(5^(1/2)/2 + 1/2)^n)/10 - (3*(1/2 - 5^(1/2)/2)^n)/2 + ...
(5^(1/2)/2 + 1/2)^n/2
```

Visually inspect `pSol`. Notice that `pSol` is a sum of terms. Each term is a ratio that can increase or decrease as `n` increases. For each term, you can confirm this hypothesis in several ways:

- Check if the limit at `n = Inf` goes to `0` or `Inf` by using `limit`.
- Plot the term for increasing `n` and check behavior.
- Calculate the value at a large value of `n`.

For simplicity, use the third approach. Calculate the terms at `n = 100`, and then verify the approach. First, find the individual terms by using `children`, substitute for `n`, and convert to `double`.

```

pSolTerms = children(pSol);
pSolTermsDbl = subs(pSolTerms,n,100);
pSolTermsDbl = double(pSolTermsDbl)

pSolTermsDbl =
    1.0e+20 *
    0.00000  -0.00000  5.3134  -0.00000  3.9604

```

The result shows that some terms are 0 while other terms have a large magnitude. Hypothesize that the large-magnitude terms produce the exponential behavior. Approximate pSol with these terms.

```

idx = abs(pSolTermsDbl)>1; % use arbitrary cutoff
pApprox = pSolTerms(idx);
pApprox = sum(pApprox)

pApprox =
(3*5^(1/2)*(5^(1/2)/2 + 1/2)^n)/10 + (5^(1/2)/2 + 1/2)^n/2

```

Verify the hypothesis by plotting the approximation error between pSol and pApprox. As expected, the error goes to 0 as n increases. This result demonstrates how symbolic calculations help you analyze your problem.

```

Perror = pSol - pApprox;
nValues = 1:30;
Perror = subs(Perror,n,nValues);
stem(nValues,Perror)
xlabel('Years (n)')
ylabel('Error (pSol - pApprox)')
title('Error in Approximation')

```

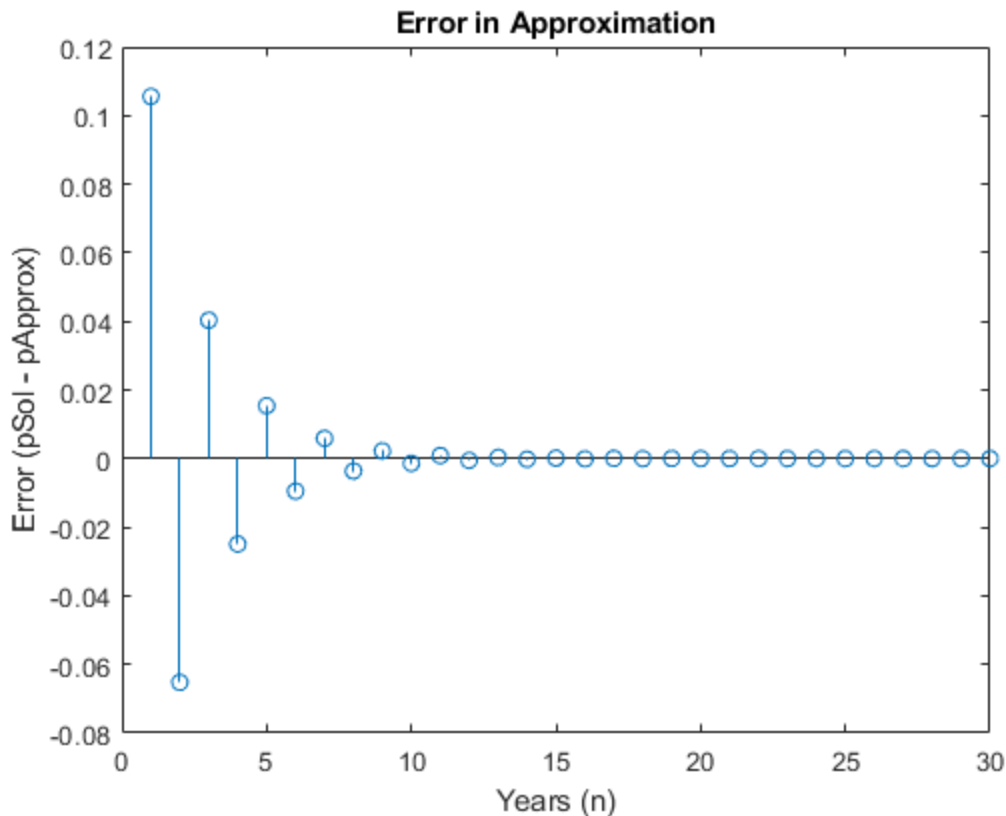

References

- [1] Andrews, L.C., Shivamoggi, B.K., *Integral Transforms for Engineers and Applied Mathematicians*, Macmillan Publishing Company, New York, 1986
- [2] Crandall, R.E., *Projects in Scientific Computation*, Springer-Verlag Publishers, New York, 1994
- [3] Strang, G., *Introduction to Applied Mathematics*, Wellesley-Cambridge Press, Wellesley, MA, 1986

Create Plots

In this section...

“Plot with Symbolic Plotting Functions” on page 2-229

“Plot Functions Numerically” on page 2-231

“Plot Multiple Symbolic Functions in One Graph” on page 2-232

“Plot Multiple Symbolic Functions in One Figure” on page 2-233

“Combine Symbolic Function Plots and Numeric Data Plots” on page 2-234

“Combine Numeric and Symbolic Plots in 3-D” on page 2-236

Plot with Symbolic Plotting Functions

MATLAB provides many techniques for plotting numerical data. Graphical capabilities of MATLAB include plotting tools, standard plotting functions, graphic manipulation and data exploration tools, and tools for printing and exporting graphics to standard formats. Symbolic Math Toolbox expands these graphical capabilities and lets you plot symbolic functions using:

- `fplot` to create 2-D plots of symbolic expressions, equations, or functions in Cartesian coordinates.
- `fplot3` to create 3-D parametric plots.
- `ezpolar` to create plots in polar coordinates.
- `fsurf` to create surface plots.
- `fcontour` to create contour plots.
- `fmesh` to create mesh plots.

Plot the symbolic expression $\sin(6x)$ by using `fplot`. By default, `fplot` uses the range $-5 < x < 5$.

```
syms x
fplot(sin(6*x))
```

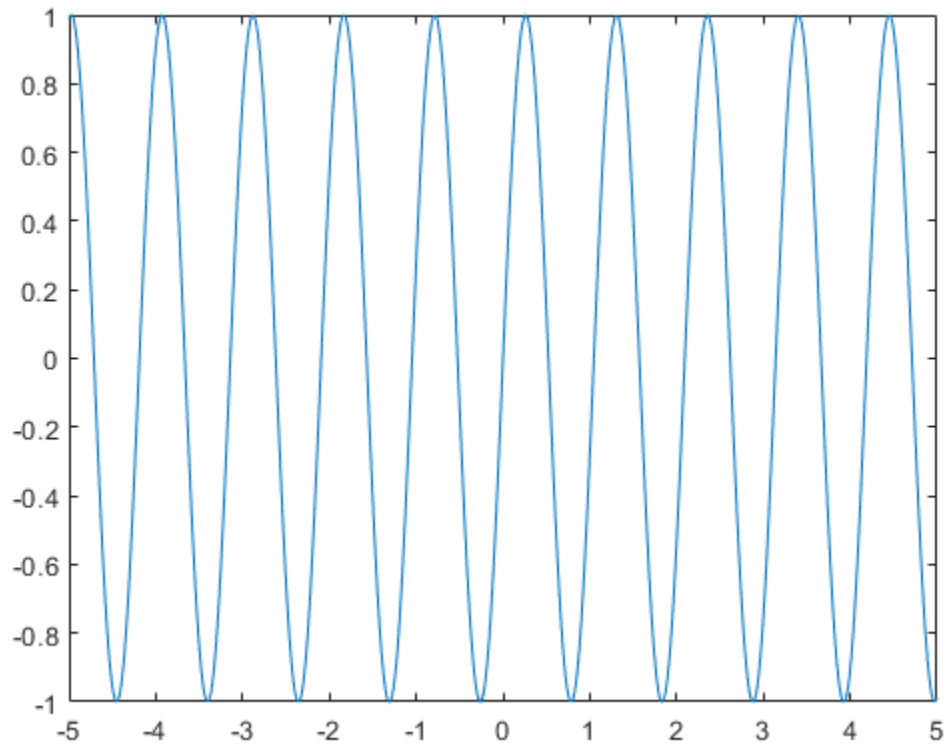

Plot a symbolic expression or function in polar coordinates r (radius) and θ (polar angle) by using `ezpolar`. By default, `ezpolar` plots a symbolic expression or function over the interval $0 < \theta < 2\pi$.

Plot the symbolic expression $\sin(6t)$ in polar coordinates.

```
syms t
ezpolar(sin(6*t))
```

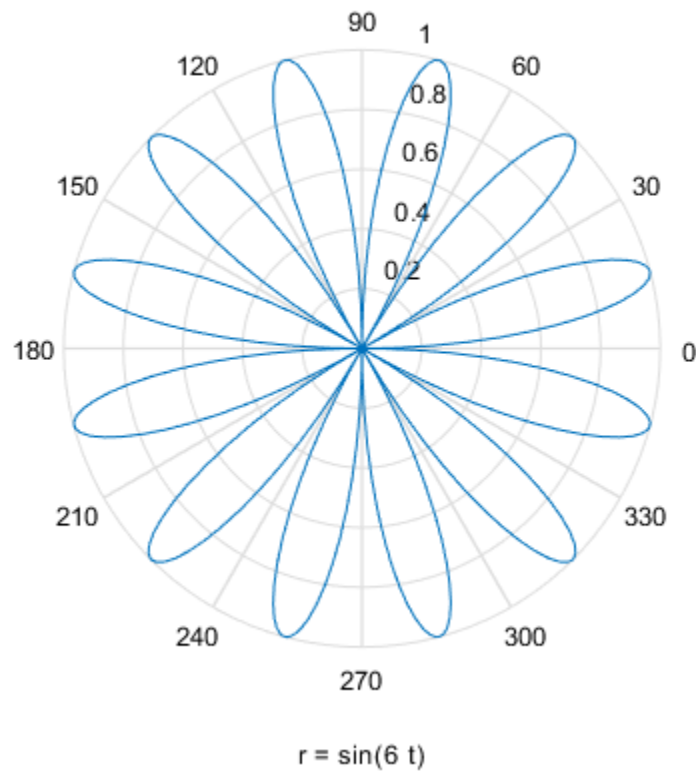

Plot Functions Numerically

As an alternative to plotting expressions symbolically, you can substitute symbolic variables with numeric values by using `subs`. Then, you can use these numeric values with plotting functions in MATLAB™.

In the following expressions `u` and `v`, substitute the symbolic variables `x` and `y` with the numeric values defined by `meshgrid`.

```
syms x y
u = sin(x^2 + y^2);
v = cos(x*y);
[X, Y] = meshgrid(-1:.1:1, -1:.1:1);
U = subs(u, [x y], {X,Y});
V = subs(v, [x y], {X,Y});
```

Now, you can plot `U` and `V` by using standard MATLAB plotting functions.

Create a plot of the vector field defined by the functions `U(X,Y)` and `V(X,Y)` by using the MATLAB `quiver` function.

```
quiver(X, Y, U, V)
```

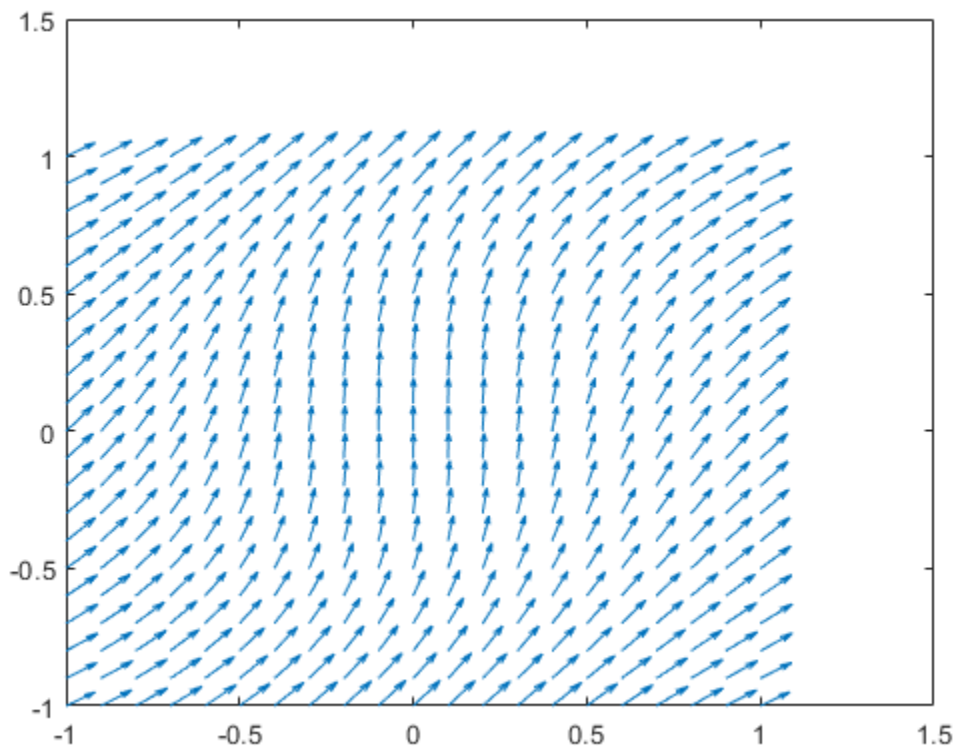

Plot Multiple Symbolic Functions in One Graph

Plot several functions on one graph by adding the functions sequentially. After plotting the first function, add successive functions by using the `hold on` command. The `hold on` command keeps the existing plots. Without the `hold on` command, each new plot replaces any existing plot. After the `hold on` command, each new plot appears on top of existing plots. Switch back to the default behavior of replacing plots by using the `hold off` command.

Plot $f = e^x \sin(20x)$ using `fplot`. Show the bounds of f by superimposing plots of e^x and $-e^x$ as dashed red lines. Set the title by using the `DisplayName` property of the object returned by `fplot`.

```
syms x y
f = exp(x)*sin(20*x)

f = sin(20 x) e^x

obj = fplot(f,[0 3]);
hold on
fplot(exp(x), [0 3], '--r')
fplot(-exp(x), [0 3], '--r')
title(obj.DisplayName)
hold off
```

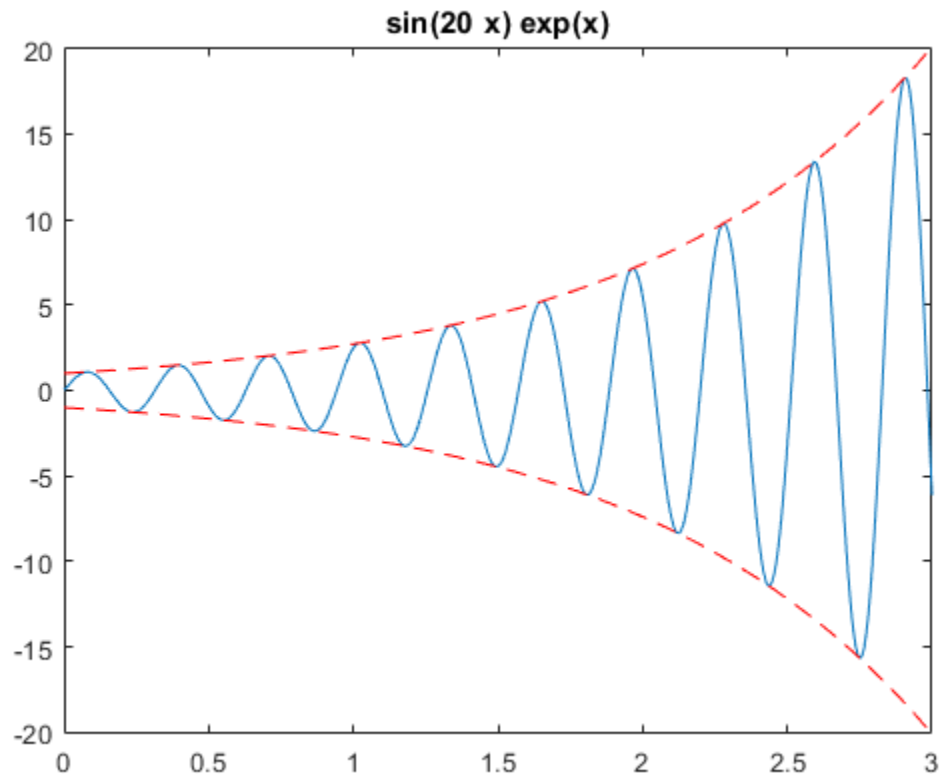

Plot Multiple Symbolic Functions in One Figure

Display several functions side-by-side in one figure by dividing the figure window into several subplots using `subplot`. The command `subplot(m, n, p)` divides the figure into a m by n matrix of subplots and selects the subplot p . Display multiple plots in separate subplots by selecting the subplot and using plotting commands. Plotting into multiple subplots is useful for side-by-side comparisons of plots.

Compare plots of $\sin((x^2 + y^2)/a)$ for $a = 10, 20, 50, 100$ by using `subplot` to create side-by-side subplots.

```
syms x y a
f = sin((x^2 + y^2)/a);

subplot(2, 2, 1)
fsurf(subs(f, a, 10))
title('a = 10')

subplot(2, 2, 2)
fsurf(subs(f, a, 20))
title('a = 20')

subplot(2, 2, 3)
fsurf(subs(f, a, 50))
title('a = 50')
```

```
subplot(2, 2, 4)
fsurf(subs(f, a, 100))
title('a = 100')
```

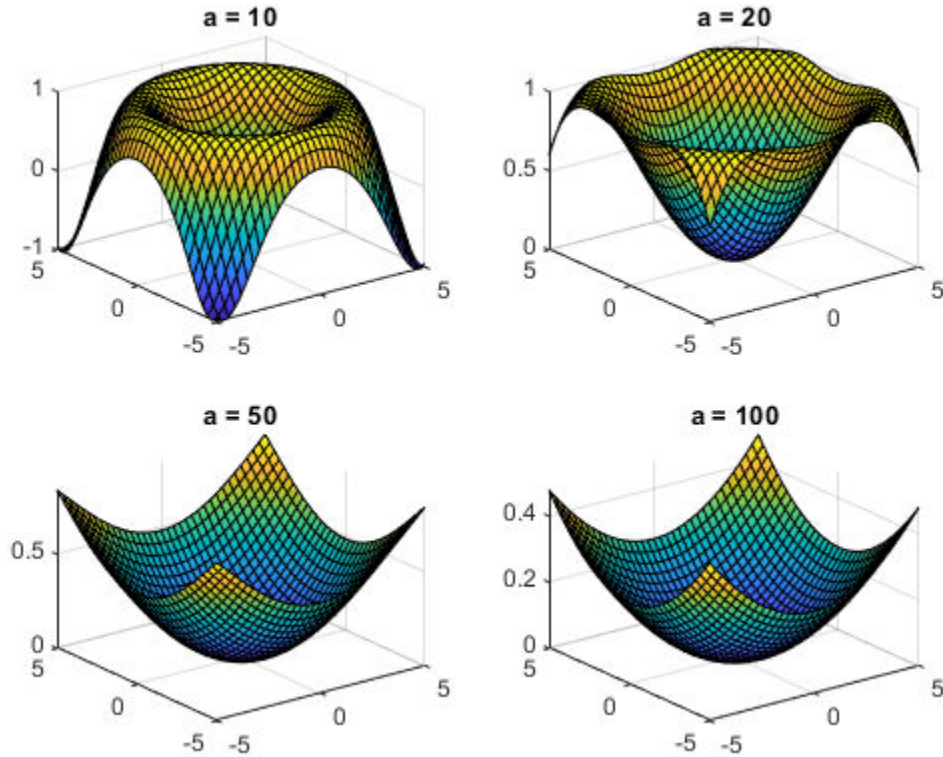

Combine Symbolic Function Plots and Numeric Data Plots

Plot numeric and symbolic data on the same graph by using MATLAB and Symbolic Math Toolbox functions together.

For numeric values of x between $[-5, 5]$, return a noisy sine curve by finding $y = \sin(x)$ and adding random values to y . View the noisy sine curve by using `scatter` to plot the points $(x_1, y_1), (x_2, y_2), \dots$.

```
x = linspace(-5,5);
y = sin(x) + (-1).^randi(10, 1, 100).*rand(1, 100)./2;
scatter(x, y)
```

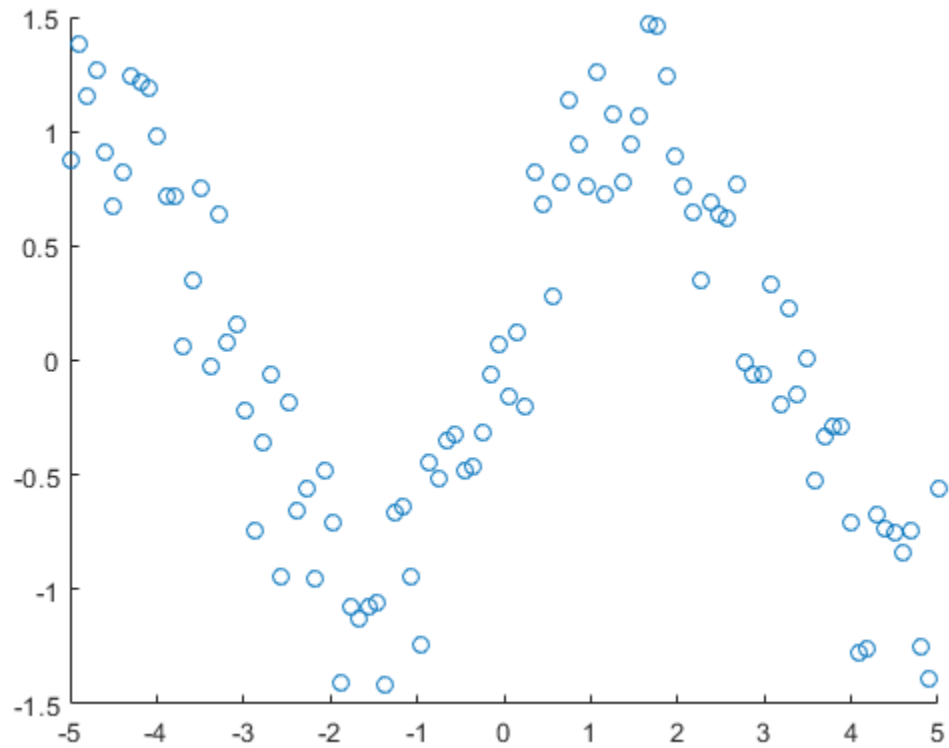

Show the underlying structure in the points by superimposing a plot of the sine function. First, use `hold on` to retain the scatter plot. Then, use `fplot` to plot the sine function.

```
hold on
syms t
fplot(sin(t))
hold off
```

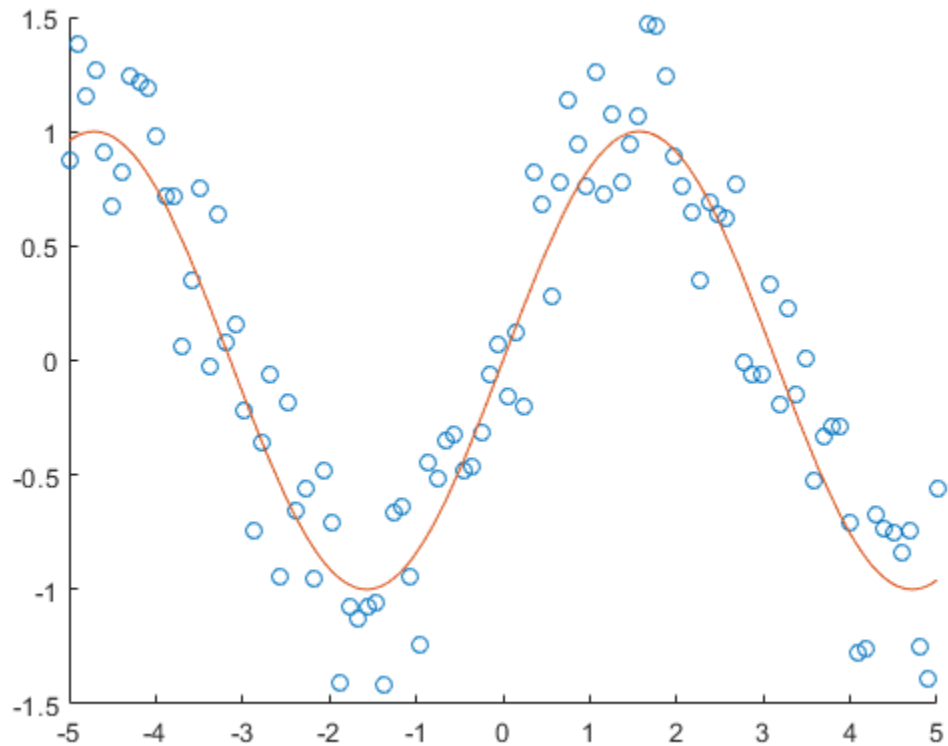

Combine Numeric and Symbolic Plots in 3-D

Combine symbolic and numeric plots in 3-D by using MATLAB and Symbolic Math Toolbox plotting functions. Symbolic Math Toolbox provides these 3-D plotting functions:

- `fplot3` creates 3-D parameterized line plots.
- `fsurf` creates 3-D surface plots.
- `fmesh` creates 3-D mesh plots.

Create a spiral plot by using `fplot3` to plot the parametric line

$$x = (1 - t)\sin(100t)$$

$$y = (1 - t)\cos(100t)$$

$$z = \sqrt{1 - x^2 - y^2}.$$

```
syms t
x = (1-t)*sin(100*t);
y = (1-t)*cos(100*t);
z = sqrt(1 - x^2 - y^2);
fplot3(x, y, z, [0 1])
title('Symbolic 3-D Parametric Line')
```

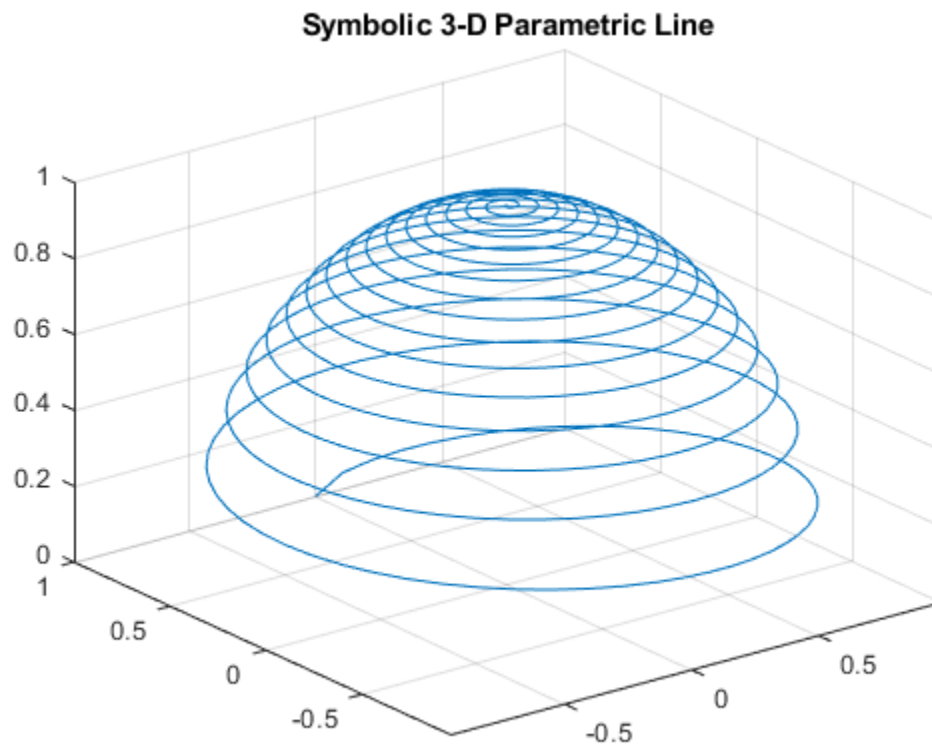
Superimpose a plot of a sphere with radius 1 and center at $(0, 0, 0)$. Find points on the sphere numerically by using `sphere`. Plot the sphere by using `mesh`. The resulting plot shows the symbolic parametric line wrapped around the top hemisphere.

```
hold on
[X,Y,Z] = sphere;
mesh(X, Y, Z)
colormap(gray)
title('Symbolic Parametric Plot and a Sphere')
hold off
```

Symbolic Parametric Plot and a Sphere

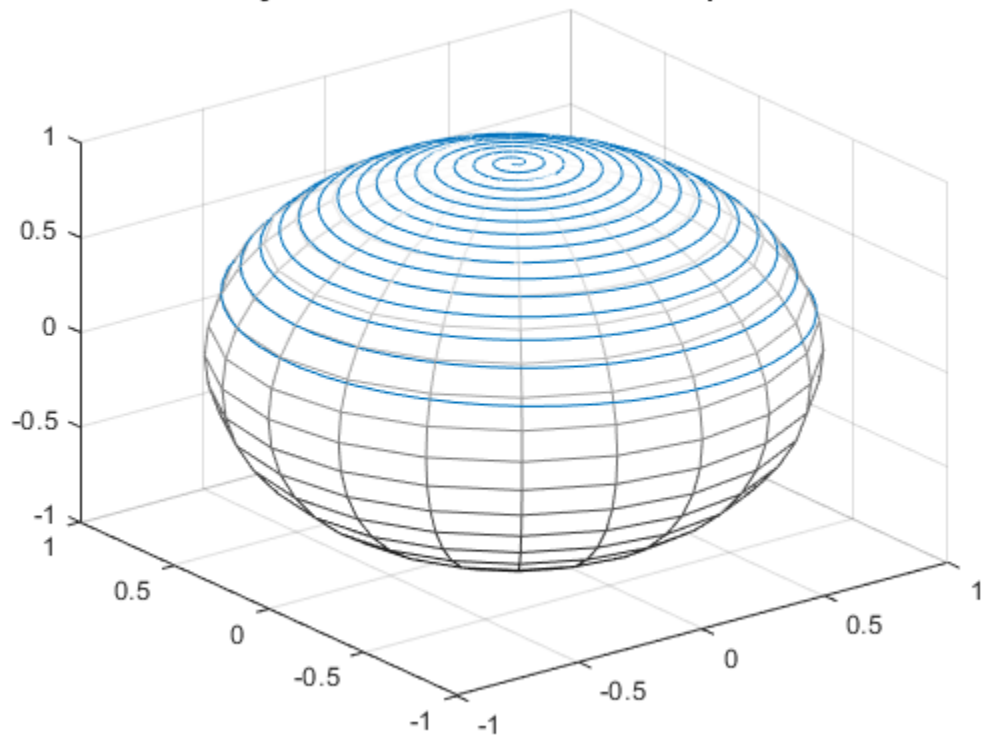

Plotting in Spherical Coordinate System

This example shows how to plot a point in spherical coordinates and its projection to Cartesian coordinates.

In spherical coordinates, the location of a point P can be characterized by three coordinates:

- the radial distance ρ
- the azimuthal angle θ
- the polar angle ϕ

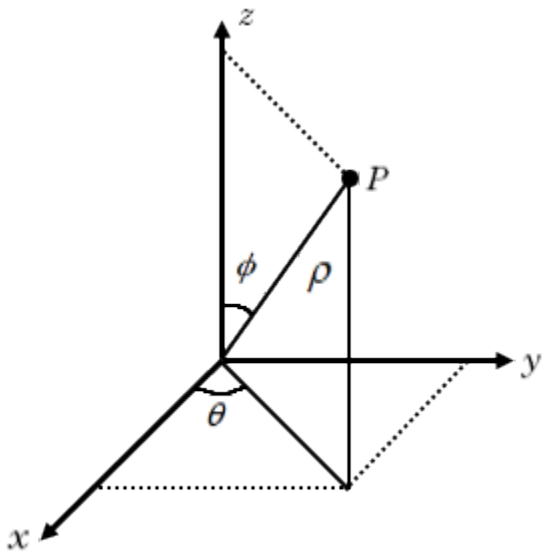

The relationship between the Cartesian coordinates (x, y, z) of the point P and its spherical coordinates (ρ, θ, ϕ) are:

$$\begin{aligned}x &= \rho \sin \phi \cos \theta \\y &= \rho \sin \phi \sin \theta \\z &= \rho \cos \phi\end{aligned}$$

Plot the point P using `plot3`. You can adjust the location of the point by changing the values of `rho`, `theta`, and `phi`.

```
rho = ;
theta = ;
phi = ;
x = rho*sin(phi)*cos(theta);
y = rho*sin(phi)*sin(theta);
z = rho*cos(phi);
plot3(x,y,z, 'ko', 'MarkerSize', 10, 'MarkerFaceColor', 'k')
hold on
```

Plot the line projection of the point P onto the z -axis and the xy -plane using `fplot3`.

```
syms r s
xr = r*sin(phi)*cos(theta);
```

```

yr = r*sin(phi)*sin(theta);
zr = r*cos(phi);
fplot3(xr,yr,zr,[0 rho],'k')
fplot3(xr,yr,sym(0),[0 rho],'k')
fplot3(xr,yr,sym(z),[0 rho],'k--')
fplot3(sym(x),sym(y),rho*sin(s),[0 pi/2-phi],'k')

```

Plot the planes that show the span of the azimuthal angle θ and the polar angle ϕ .

```

syms s t
xa = rho*sin(s)*cos(t);
ya = rho*sin(s)*sin(t);
fsurf(xa,ya,0,[0 phi 0 theta],'FaceColor','b','EdgeColor','none')
syms u v
xp = u*sin(v)*cos(theta);
yp = u*sin(v)*sin(theta);
zp = u*cos(v);
fsurf(xp,yp,zp,[0 rho 0 phi],'FaceColor','g','EdgeColor','none')
xlabel('x')
ylabel('y')
zlabel('z')
view(115,30)
axis equal;
hold off

```

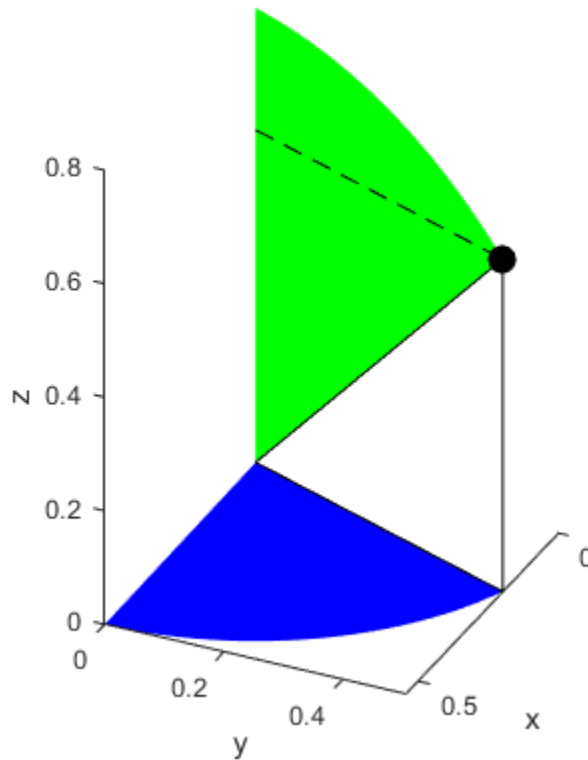

Analytical Solutions of the Inverse Kinematics of a Humanoid Robot

This example shows how to derive analytical solutions for the inverse kinematics of the head chain of a humanoid robot.

Step 1: Define Parameters

Describe the kinematics of the head-chain link (the link between the torso and the head) of the NAO humanoid robot [1] using the Denavit-Hartenberg (DH) parameters and notations based on a study by Kofinas et al. [2]. The following transformation defines the head-chain link.

$$T = A_{Base,0} T_{0,1} T_{1,2} R_x R_y A_{2,Head}$$

where:

- $A_{Base,0}$ is the translation from the base (torso) to the joint or reference frame 0
- $T_{0,1}$ is the orientation of reference 1 relative to 0
- $T_{1,2}$ is the orientation of reference 2 relative to 1
- R_x is the roll rotation
- R_y is the pitch rotation
- $A_{2,Head}$ is the translation from reference 2 to the end-effector point (the head)

$T(1:3,4)$ defines the coordinates of the head, which are x_c , y_c , z_c .

In this example, you analytically solve the inverse kinematics problem by returning all orientations of individual joints in the head-chain link given head coordinates of x_c , y_c , and z_c within the reachable space. Then, you convert the analytical results to purely numeric functions for efficiency.

Solving analytically (when doing so is possible) lets you perform computations in real time and avoid singularities, which cause difficulty for numerical methods.

Step 2: Define Forward Kinematics of Head Chain Using DH Parameters

The function `getKinematicChain` returns the specific kinematic chain for the NAO robot in terms of symbolic variables. For details on `getKinematicChain`, see the Helper Functions section.

```
kinChain = 'head';
dhInfo = getKinematicChain(kinChain);
T = dhInfo.T
```

$$T = \begin{pmatrix} r_{11} & r_{12} & r_{13} & x_c \\ r_{21} & r_{22} & r_{23} & y_c \\ r_{31} & r_{32} & r_{33} & z_c \\ 0 & 0 & 0 & 1 \end{pmatrix}$$

Express the forward kinematics transformation matrix T as the following sequence of products: $T = A_{Base0} * T_{01} * T_{12} * R_x * R_y * A_{2Head}$. Define the individual matrices as follows.

Specify the translation matrix from the torso (base) to joint 0.

`ABase0 = dhInfo.ABase0`

$$\text{ABase0} = \begin{pmatrix} 1 & 0 & 0 & 0 \\ 0 & 1 & 0 & 0 \\ 0 & 0 & 1 & \text{NeckOffsetZ} \\ 0 & 0 & 0 & 1 \end{pmatrix}$$

Specify the transformation matrix from joint 0 to joint 1.

`T01 = dhInfo.T01`

$$\text{T01} = \begin{pmatrix} \cos(\theta_1) & -\sin(\theta_1) & 0 & 0 \\ \sin(\theta_1) & \cos(\theta_1) & 0 & 0 \\ 0 & 0 & 1 & 0 \\ 0 & 0 & 0 & 1 \end{pmatrix}$$

Specify the transformation matrix from joint 1 to joint 2.

`T12 = dhInfo.T12`

$$\text{T12} = \begin{pmatrix} \cos\left(\theta_2 - \frac{\pi}{2}\right) & -\sin\left(\theta_2 - \frac{\pi}{2}\right) & 0 & 0 \\ 0 & 0 & 1 & 0 \\ -\sin\left(\theta_2 - \frac{\pi}{2}\right) & -\cos\left(\theta_2 - \frac{\pi}{2}\right) & 0 & 0 \\ 0 & 0 & 0 & 1 \end{pmatrix}$$

Specify the roll rotation matrix.

`Rx = dhInfo.Rx`

$$\text{Rx} = \begin{pmatrix} 1 & 0 & 0 & 0 \\ 0 & 0 & -1 & 0 \\ 0 & 1 & 0 & 0 \\ 0 & 0 & 0 & 1 \end{pmatrix}$$

Specify the pitch rotation matrix.

`Ry = dhInfo.Ry`

$$\text{Ry} = \begin{pmatrix} 0 & 0 & 1 & 0 \\ 0 & 1 & 0 & 0 \\ -1 & 0 & 0 & 0 \\ 0 & 0 & 0 & 1 \end{pmatrix}$$

Specify the translation matrix from joint 2 to the head.

`A2Head = dhInfo.A2Head`

`A2Head =`

$$\begin{pmatrix} 1 & 0 & 0 & \text{CameraX} \\ 0 & 1 & 0 & 0 \\ 0 & 0 & 1 & \text{CameraZ} \\ 0 & 0 & 0 & 1 \end{pmatrix}$$

The known parameters of this problem are CameraX, CameraZ, NeckOffsetZ, and the positions xc, yc, and zc. The unknown parameters are θ_1 and θ_2 . After finding θ_1 and θ_2 , you can compute the individual transformations of T. The robot can then achieve the desired position xc, yc, zc.

Although you can see these parameters in the transformation matrices, they do not exist as variables in the MATLAB base workspace. This is because these parameters originate from a function. Functions do not use the base workspace. Each function workspace is separate from the base workspace and all other workspaces to protect the data integrity. Thus, to use these variables outside of the function getKinematicChain, use syms to create them.

```
syms CameraX CameraZ NeckOffsetZ xc yc zc theta_1 theta_2 real;
```

Step 3: Find Algebraic Solutions for θ_1 and θ_2

Rewrite the equation $T = A_{Base0} * T_{01} * T_{12} * R_x * R_y * A_{2Head}$, separating the terms that describe the torso and head movements of the robot: $\text{inv}(T_{01}) * \text{inv}(A_{Base0}) * T = T_{12} * R_x * R_y * A_{2Head}$. Simplify the left and right sides of the equation, and define equations of interest matching the expressions for coordinate positions.

```
LHS = simplify(inv(T01)*inv(ABase0)*T);
RHS = simplify(T12*Rx*Ry*A2Head);
eqns = LHS(1:3,end) - RHS(1:3,end)
```

```
eqns =

$$\begin{pmatrix} xc \cos(\theta_1) - \text{CameraZ} \sin(\theta_2) - \text{CameraX} \cos(\theta_2) + yc \sin(\theta_1) \\ yc \cos(\theta_1) - xc \sin(\theta_1) \\ zc - \text{NeckOffsetZ} - \text{CameraZ} \cos(\theta_2) + \text{CameraX} \sin(\theta_2) \end{pmatrix}$$

```

This system of equations contains two variables for which you want to find solutions, θ_1 and θ_2 . However, the equations also imply that you cannot arbitrarily choose xc, yc, and zc. Therefore, also consider yc as a variable. All other unknowns of the system are symbolic parameters.

This example follows a typical algebraic approach for solving inverse kinematics problems [3]. The idea is to get a compact representation of the solution, where the expression of each variable is in terms of parameters and variables for which you already solved the equations. As a first step, find either θ_1 or θ_2 in terms of the parameters. Then, express the other variable in terms of the known variable and parameters. To do this, start by identifying the equation that has only one variable.

```
intersect(symvar(eqns(1)), [theta_1, theta_2, yc])
```

```
ans = ( $\theta_1$   $\theta_2$  yc)
```

```
intersect(symvar(eqns(2)), [theta_1, theta_2, yc])
```

```
ans = ( $\theta_1$  yc)
```

```
intersect(symvar(eqns(3)), [theta_1, theta_2, yc])
```

```
ans =  $\theta_2$ 
```

The third equation contains only one variable, θ_2 . Solve this equation first.

```
[theta_2_sol,theta_2_params,theta_2_conds] = ...
    solve(eqns(3),theta_2,'Real',true,'ReturnConditions',true)
```

```
theta_2_sol =
    ( 2 pi k - 2 atan( (CameraX - sqrt(CameraX^2 + CameraZ^2 - NeckOffsetZ^2 + 2 NeckOffsetZ zc - zc^2)) / (CameraZ - NeckOffsetZ + zc) )
    ( 2 pi k - 2 atan( (CameraX + sqrt(CameraX^2 + CameraZ^2 - NeckOffsetZ^2 + 2 NeckOffsetZ zc - zc^2)) / (CameraZ - NeckOffsetZ + zc) ) )
```

```
theta_2_params = k
```

```
theta_2_conds =
    (CameraZ + zc ≠ NeckOffsetZ ∧ (NeckOffsetZ - zc)2 ≤ CameraX2 + CameraZ2 ∧ k ∈ ℤ)
    (CameraZ + zc ≠ NeckOffsetZ ∧ (NeckOffsetZ - zc)2 ≤ CameraX2 + CameraZ2 ∧ k ∈ ℤ)
```

The solutions have an additive $2\pi k$ term with the parameter k . Without loss of generalization, you can set k equal to 0 in the solutions and conditions.

```
theta_2_sol = subs(theta_2_sol,theta_2_params,0)
```

```
theta_2_sol =
    ( -2 atan( (CameraX - sqrt(CameraX^2 + CameraZ^2 - NeckOffsetZ^2 + 2 NeckOffsetZ zc - zc^2)) / (CameraZ - NeckOffsetZ + zc) )
    ( -2 atan( (CameraX + sqrt(CameraX^2 + CameraZ^2 - NeckOffsetZ^2 + 2 NeckOffsetZ zc - zc^2)) / (CameraZ - NeckOffsetZ + zc) ) )
```

```
for p = 1:numel(theta_2_conds)
    theta_2_conds(p) = simplify(subs(theta_2_conds(p),theta_2_params,0));
end
```

Now solve for the variables θ_1 and yc in terms of the variable θ_2 and other symbolic parameters.

```
[theta_1_sol,yc_sol,yc_theta_1_params,yc_theta_1_conds] = ...
    solve(eqns(1:2),theta_1,yc,'Real',true,'ReturnConditions',true);
```

Display the solutions for θ_1 and yc .

```
theta_1_sol
```

```
theta_1_sol =
```

$$\begin{pmatrix} 2\pi k - \sigma_1 \\ \sigma_2 + 2\pi k \\ 2\pi k - \sigma_2 \\ 2\pi k - \frac{\pi}{2} \\ \sigma_1 + 2\pi k \\ 2\operatorname{atan}(x) + 2\pi k \\ \frac{\pi}{2} + 2\pi k \\ 2\pi k - \frac{\pi}{2} \\ \frac{\pi}{2} + 2\pi k \end{pmatrix}$$

where

$$\sigma_1 = 2 \operatorname{atan}\left(\frac{\sqrt{(\operatorname{CameraX} + xc)(\operatorname{CameraX} - xc)}}{\operatorname{CameraX} - xc}\right)$$

$$\sigma_2 = 2 \operatorname{atan}\left(\frac{\frac{\sigma_3}{\sigma_5 + 1} + \frac{\sigma_5 \sigma_3}{\sigma_5 + 1}}{\sigma_4}\right)$$

$$\sigma_3 = \sqrt{-\left(xc - \operatorname{CameraX} + \operatorname{CameraX} \sigma_5 + xc \sigma_5 - 2 \operatorname{CameraZ} \tan\left(\frac{\theta_2}{2}\right)\right) \sigma_4}$$

$$\sigma_4 = \operatorname{CameraX} + xc - \operatorname{CameraX} \sigma_5 + xc \sigma_5 + 2 \operatorname{CameraZ} \tan\left(\frac{\theta_2}{2}\right)$$

$$\sigma_5 = \tan\left(\frac{\theta_2}{2}\right)^2$$

`yc_sol`

`yc_sol =`

$$\begin{pmatrix} \sqrt{(\text{CameraX} + xc)(\text{CameraX} - xc)} \\ \sigma_1 \\ -\sigma_1 \\ \text{CameraX} \\ -\sqrt{(\text{CameraX} + xc)(\text{CameraX} - xc)} \\ 0 \\ \sigma_2 \\ -\sigma_2 \\ -\text{CameraX} \end{pmatrix}$$

where

$$\sigma_1 = \frac{\sqrt{-\left(xc - \text{CameraX} + \sigma_3 + xc \tan\left(\frac{\theta_2}{2}\right)^2 - \sigma_4\right)\left(\text{CameraX} + xc - \sigma_3 + xc \tan\left(\frac{\theta_2}{2}\right)^2 + \sigma_4\right)}}{\tan\left(\frac{\theta_2}{2}\right)^2 + 1}$$

$$\sigma_2 = \frac{-\sigma_3 + \sigma_4 + \text{CameraX}}{\tan\left(\frac{\theta_2}{2}\right)^2 + 1}$$

$$\sigma_3 = \text{CameraX} \tan\left(\frac{\theta_2}{2}\right)^2$$

$$\sigma_4 = 2 \text{CameraZ} \tan\left(\frac{\theta_2}{2}\right)$$

The solutions depend on two parameters, k and x .

`yc_theta_1_params`

`yc_theta_1_params = (k x)`

The solutions have an additive $2\pi k$ term. Without loss of generalization, you can set k equal to 0 in the solution for `theta_1_sol` and the conditions `yc_theta_1_conds`.

`theta_1_sol = simplify(subs(theta_1_sol,yc_theta_1_params,[0,0]))`

`theta_1_sol =`

$$\begin{pmatrix} -2 \operatorname{atan}\left(\frac{\sqrt{(\text{CameraX} + xc)(\text{CameraX} - xc)}}{\text{CameraX} - xc}\right) \\ \sigma_1 \\ -\sigma_1 \\ -\frac{\pi}{2} \\ 2 \operatorname{atan}\left(\frac{\sqrt{(\text{CameraX} + xc)(\text{CameraX} - xc)}}{\text{CameraX} - xc}\right) \\ 0 \\ \frac{\pi}{2} \\ -\frac{\pi}{2} \\ \frac{\pi}{2} \end{pmatrix}$$

where

$$\sigma_1 = 2 \operatorname{atan}\left(\frac{\sqrt{(\text{CameraX} \cos(\theta_2) - xc + \text{CameraZ} \sin(\theta_2))(xc + \text{CameraX} \cos(\theta_2) + \text{CameraZ} \sin(\theta_2))}}{xc + \text{CameraX} \cos(\theta_2) + \text{CameraZ} \sin(\theta_2)}\right)$$

```
for p = 1:numel(yc_theta_1_conds)
    yc_theta_1_conds(p) = simplify(subs(yc_theta_1_conds(p),yc_theta_1_params,[0,0]));
end
```

A similar substitution is not required for `yc_sol` since there is no dependency on the parameters.

```
intersect(symvar(yc_sol),yc_theta_1_params)
```

```
ans =
```

```
Empty sym: 1-by-0
```

Step 4: Verify the Solutions

Starting with an arbitrary set of known numeric values for θ_1 and θ_2 , compute the numeric values of the end-effector positions xc , yc , and zc with forward kinematics. Then, work backwards from xc , yc , and zc to compute all possible numeric values for θ_1 and θ_2 using the inverse kinematics expressions from the previous computation. Verify that one set of the inverse solutions matches the starting set of numeric values for θ_1 and θ_2 .

Set the fixed parameters for the robot. The values in this example are for illustration purposes only.

```
CameraXValue = 53.9;
CameraZValue = 67.9;
NeckOffsetZValue = -5;
```

Using forward computations, find the end-effector positions corresponding to the values θ_1 and θ_2 .

```
Tfk = ABase0*T01*T12*Rx*Ry*A2Head;
xyz = Tfk(1:3,end);
```

Create a symbolic function for these positions.

```
xyzFunc = symfun(subs(xyz,[CameraX,CameraZ,NeckOffsetZ], ...
    [CameraXValue,CameraZValue,NeckOffsetZValue]),[theta_1,theta_2]);
```

For forward kinematics, specify two variables `theta_1_known` and `theta_2_known` that contain an arbitrary starting set of values for θ_1 and θ_2 .

```
theta_1_known = [pi/4,pi/6,pi/8,pi/10];
theta_2_known = [pi/8,-pi/12,pi/16,-pi/10];
numPts = numel(theta_1_known);
num_theta_2 = numel(theta_2_sol);
num_theta_1 = numel(theta_1_sol);
```

Note that there are potentially `num_theta_1` solutions for each `num_theta_2` solution.

Use the following sequence of operations to verify the solutions.

- 1 Loop over (`theta_1_known`, `theta_2_known`). For each point, compute the end positions `x_known`, `y_known`, and `z_known`, which are then "known".
- 2 Loop over the solutions for θ_2 corresponding to `x_known` and `z_known`. For each solution, check to see if the corresponding condition `cond_theta_2` is valid. If the condition is valid, compute the corresponding numeric solution `theta_2_derived`.
- 3 Loop over the solutions for θ_1 corresponding to `x_known`, `z_known`, and `theta_2_derived`. For each solution, check to see if the corresponding condition `cond_theta_1` is valid. If the condition is valid, check to see if `y_derived` numerically matches `y_known` within relative and absolute tolerances through the condition `cond_yc`. If this condition is valid, then compute `theta_1_derived`.
- 4 Collect the results in a table `T` for display purposes.

```
T = table([],[],[],[],'VariableNames',{ 'theta_1_known', 'theta_2_known', ...
    'theta_1_derived', 'theta_2_derived'});

for ix1 = 1:numPts
xyz_known = double(xyzFunc(theta_1_known(ix1),theta_2_known(ix1)));
x_known = xyz_known(1);
y_known = xyz_known(2);
z_known = xyz_known(3);
for ix2 = 1:num_theta_2 % theta_2 loop
    cond_theta_2 = subs(theta_2_conds(ix2),[CameraX,CameraZ,NeckOffsetZ,xc,zc],...
        [CameraXValue,CameraZValue,NeckOffsetZValue,x_known,z_known]);
    if isAlways(cond_theta_2) % if theta_2 is valid
        theta_2_derived = subs(theta_2_sol(ix2),[CameraX,CameraZ,NeckOffsetZ,xc,zc],...
            [CameraXValue,CameraZValue,NeckOffsetZValue,x_known,z_known]);
        theta_2_derived = double(theta_2_derived);
        for ix3 = 1:num_theta_1 % theta_1 loop
            cond_theta_1 = subs(yc_theta_1_conds(ix3),[CameraX,CameraZ,NeckOffsetZ,theta_2,xc,zc],...
                [CameraXValue,CameraZValue,NeckOffsetZValue,theta_2_derived,x_known,z_known]);
            if isAlways(cond_theta_1) % if theta_1 is valid
                y_derived = subs(yc_sol(ix3),[CameraX,CameraZ,NeckOffsetZ,theta_2,xc,zc],...
                    [CameraXValue,CameraZValue,NeckOffsetZValue,theta_2_derived,x_known,z_known]);
                y_derived = double(y_derived);
                cond_yc = abs(y_known - y_derived) < max(100*eps,1e-6*abs(y_known)); % check rounding
                if isAlways(cond_yc) % if yc is valid
                    theta_1_derived = subs(theta_1_sol(ix3),[CameraX,CameraZ,NeckOffsetZ,theta_2,xc,zc],...
                        [CameraXValue,CameraZValue,NeckOffsetZValue,theta_2_derived,x_known,z_known]);
                    theta_1_derived = double(theta_1_derived);
```

```

    T = vertcat(T,table(theta_1_known(ix1),theta_2_known(ix1),theta_1_derived,...
        theta_2_derived,'VariableNames',T.Properties.VariableNames));
    end
end
end
end
end
end
end
end
T

```

```

T=8x4 table
      theta_1_known      theta_2_known      theta_1_derived      theta_2_derived
                                                                
    0.7854           0.3927           0.7854           0.3927
    0.7854           0.3927           -2.3562          -1.7346
    0.5236          -0.2618           0.5236          -0.2618
    0.5236          -0.2618           -2.618           -1.0801
    0.3927           0.19635           0.3927           0.19635
    0.3927           0.19635           -2.7489          -1.5383
    0.31416         -0.31416           0.31416          -0.31416
    0.31416         -0.31416           -2.8274          -1.0278

```

Observe that there are two possible solution pairs ($\theta_{1_derived}, \theta_{2_derived}$) obtained using inverse kinematics for each pair of starting angles ($\theta_{1_known}, \theta_{2_known}$). One set of the inverse solutions matches the starting angles.

References

- 1 SoftBank Robotics. *NAO*. <https://www.softbankrobotics.com/emea/en/nao>.
- 2 Kofinas, N., E. Orfanoudakis, and M. G. Lagoudakis. "Complete Analytical Inverse Kinematics for NAO." In *2013 13th International Conference on Autonomous Robot Systems*. Lisbon, Portugal: Robotica, 2013.
- 3 Kendricks, K. "Solving the Inverse Kinematic Robotics Problem: A Comparison Study of the Denavit-Hartenberg Matrix and Groebner Basis Theory." Ph.D. Thesis. Auburn University, Auburn, AL, 2007.

Helper Functions

```

function kinChain = getKinematicChain(link)
% This function returns the kinematic chain of the NAO humanoid robot
% represented using Denavit-Hartenberg (DH) parameters.
% The function uses as a reference the paper: Complete analytical inverse
% kinematics for NAO by Kofinas, N., Orfanoudakis, E., Lagoudakis, M.G.,
% 2013 13th International Conference on Autonomous Robot Systems
% (Robotica), Publication Year: 2013.
    if nargin < 1
        link = 'head';
    end
    % Notation: A, R, and T are the translation, rotation, and DH
    % transformation matrices, respectively.
    % Specify DH parameters for the desired end configuration.
    syms r11 r12 r13 r21 r22 r23 r31 r32 r33 xc yc zc real;
    R = [r11 r12 r13;r21 r22 r23;r31 r32 r33];
    kinChain.T = [R,[xc;yc;zc];0,0,0,1];
    switch link

```

```

case 'head' % Kinematic chain from torso (base) to head.
    syms CameraX CameraZ NeckOffsetZ real;
    % Translation from torso (base) to joint 0.
    ABase0 = getA([0 0 NeckOffsetZ]);
    % Translation from joint 2 to head.
    A2Head = getA([CameraX 0 CameraZ]);
    % Transformation from joint 0 to joint 1.
    % theta_1 is the rotation angle corresponding to the 0-1 link.
    syms theta_1 real;
    alpha1 = 0; a1 = 0; d1 = 0;
    T01 = getT(a1,alpha1,d1,theta_1);
    % Transformation from joint 1 to joint 2.
    % theta_2 is the rotation angle corresponding to the 1-2 link.
    syms theta_2 real;
    piBy2 = str2sym('pi/2');
    d2 = 0; a2 = 0; alpha2 = -piBy2;
    T12 = getT(a2,alpha2,d2,theta_2-piBy2);
    % Rx is the roll rotation.
    Rx = getR('x',piBy2);
    % Ry is the pitch rotation.
    Ry = getR('y',piBy2);
    % Capture the kinematic chain as a string.
    % The transformation is from the base to the head.
    kinChain.DHChain = 'ABase0*T01*T12*Rx*Ry*A2Head';
    kinChain.ABase0 = ABase0;
    kinChain.T01 = T01;
    kinChain.T12 = T12;
    kinChain.Rx = Rx;
    kinChain.Ry = Ry;
    kinChain.A2Head = A2Head;
case 'lefthand' % Kinematic chain from torso to left hand.
    syms ShoulderOffsetY ElbowOffsetY ShoulderOffsetZ real;
    ABase0 = getA([0 (ShoulderOffsetY+ElbowOffsetY) ShoulderOffsetZ]);
    syms HandOffsetX LowerArmLength real;
    AEnd4 = getA([(HandOffsetX+LowerArmLength) 0 0]);
    piBy2 = str2sym('pi/2');
    syms theta_1 real;
    alpha1 = -piBy2; a1 = 0; d1 = 0;
    T01 = getT(a1,alpha1,d1,theta_1);
    syms theta_2 real;
    d2 = 0; a2 = 0; alpha2 = piBy2;
    T12 = getT(a2,alpha2,d2,theta_2-piBy2);
    syms UpperArmLength theta_3 real;
    d3 = UpperArmLength; a3 = 0; alpha3 = -piBy2;
    T32 = getT(a3,alpha3,d3,theta_3);
    syms theta_4 real;
    d4 = 0; a4 = 0; alpha4 = piBy2;
    T43 = getT(a4,alpha4,d4,theta_4);
    Rz = getR('z',piBy2);
    kinChain.DHChain = 'ABase0*T01*T12*T32*T43*Rz*AEnd4';
    kinChain.ABase0 = ABase0;
    kinChain.T01 = T01;
    kinChain.T12 = T12;
    kinChain.T32 = T32;
    kinChain.T43 = T43;
    kinChain.Rz = Rz;
    kinChain.AEnd4 = AEnd4;
end

```

```

end

function A = getA(vec)
% This function returns the translation matrix.
    A = [1 0 0 vec(1);
         0 1 0 vec(2);
         0 0 1 vec(3);
         0 0 0 1];
end

function R = getR(orientation,theta)
% This function returns the rotation matrix.
    switch orientation
    case 'x'
        R = [1 0 0 0;
             0 cos(theta) -sin(theta) 0;
             0 sin(theta) cos(theta) 0;
             0 0 0 1];
    case 'y'
        R = [cos(theta) 0 sin(theta) 0;
             0 1 0 0;
             -sin(theta) 0 cos(theta) 0;
             0 0 0 1];
    case 'z'
        R = [cos(theta) -sin(theta) 0 0;
             sin(theta) cos(theta) 0 0;
             0 0 1 0;
             0 0 0 1];
    end
end

function T = getT(a,alpha,d,theta)
% This function returns the Denavit-Hartenberg (DH) matrix.
    T = [cos(theta), -sin(theta), 0, a;
         sin(theta)*cos(alpha), cos(theta)*cos(alpha), -sin(alpha), -sin(alpha)*d;
         sin(theta)*sin(alpha), cos(theta)*sin(alpha), cos(alpha), cos(alpha)*d;
         0,0,0,1];
end

```

Analytical Model of Cantilever Truss Structure for Simscape

This example shows how to find parameterized analytical expressions for the displacement of a joint of a trivial cantilever truss structure in both the static and frequency domains. The analytical expression for the static case is exact. The expression for the frequency response function is an approximate reduced-order version of the actual frequency response.

This example uses the following Symbolic Math Toolbox™ capabilities:

- Simscape code generation using `simscapeEquation`
- LU decomposition using `lu`
- MATLAB function generation using `matlabFunction`

Define Model Parameters

The goal of this example is to analytically relate the displacement d to the uniform cross-section area parameter A for a particular bar in the cantilever truss structure. The governing equation is represented by $M\frac{d^2x}{dt^2} + Kx = F$. Here, d results from a load at the upper-right joint of the cantilever. The truss is attached to the wall at the leftmost joints.

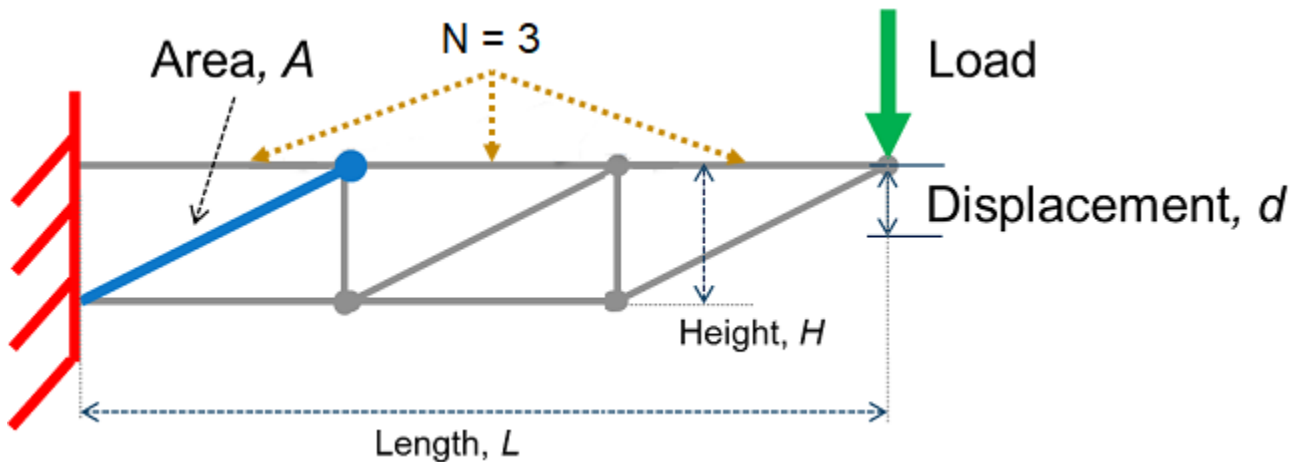

The truss bars are made of a linear elastic material with uniform density. The cross-section area A of the bar highlighted in blue (see figure) can vary. All other parameters, including the uniform cross-section areas of the other bars, are fixed. Obtain the displacement of the tip by using small and linear displacement assumptions.

First, define the fixed parameters of the truss.

Specify the length and height of the truss and the number of top horizontal truss bars.

```
L = 1.5;
H = 0.25;
N = 3;
```

Specify the density and modulus of elasticity of the truss bar material.

```
rhoval = 1e2;
Eval = 1e7;
```

Specify the cross-section area of other truss bars.

```
AFixed = 1;
```

Next, define the local stiffness matrix of the specific truss element.

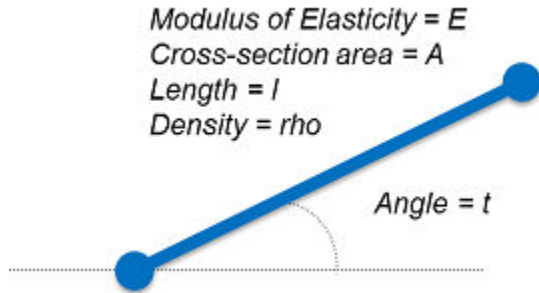

Compute the local stiffness matrix k and express it as a symbolic function. The forces and displacements of the truss element are related through the local stiffness matrix. Each node of the truss element has two degrees of freedom, horizontal and vertical displacement. The displacement of each truss element is a column matrix that corresponds to $[x_{\text{node1}}, y_{\text{node1}}, x_{\text{node2}}, y_{\text{node2}}]$. The resulting stiffness matrix is a 4-by-4 matrix.

```
syms A E l t real
G = [cos(t) sin(t) 0 0; 0 0 cos(t) sin(t)];
kk = A*E/l*[1 -1;-1 1];
k = simplify(G'*kk*G);
localStiffnessFn = symfun(k,[t,l,E])
```

```
localStiffnessFn(t, l, E) =
```

$$\begin{pmatrix} \sigma_2 & \sigma_1 & -\sigma_2 & -\sigma_1 \\ \sigma_1 & \sigma_3 & -\sigma_1 & -\sigma_3 \\ -\sigma_2 & -\sigma_1 & \sigma_2 & \sigma_1 \\ -\sigma_1 & -\sigma_3 & \sigma_1 & \sigma_3 \end{pmatrix}$$

where

$$\sigma_1 = \frac{AE \sin(2t)}{2l}$$

$$\sigma_2 = \frac{AE \cos(t)^2}{l}$$

$$\sigma_3 = \frac{AE \sin(t)^2}{l}$$

Compute the mass matrix in a similar way.

```
syms rho
mm = A*rho*l/6*[2 1;1 2];
m = simplify(G'*mm*G);
localMassFn = symfun(m,[t,l,rho]);
```

Now, define the bars of truss as a matrix `bars`. The indices for the bars, starting joints, and end joints are shown in the following figure.

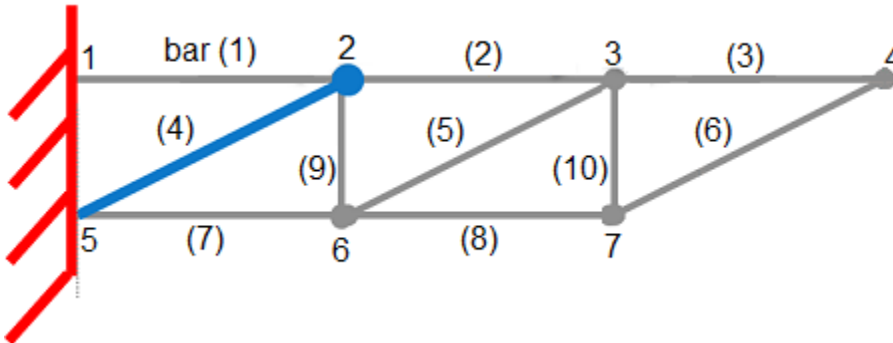

The number of rows of the matrix `bars` is the number of bars of the truss. The columns of `bars` have four elements, which represent the following parameters:

- Length (l)
- Angle with respect to the horizontal axis (t)
- Index of starting joint
- Index of ending joint

```
bars = zeros(2*N+2*(N-1),4);
```

Define the upper and diagonal bars. Note that the bar of interest is the $(N+1)$ th bar or bar number 4 which is the first diagonal bar from the left.

```
for n = 1:N
    lelem = L/N;
    bars(n,:) = [lelem,0,n,n+1];
    lelem = sqrt((L/N)^2+H^2);
    bars(N+n,:) = [lelem,atan2(H,L/N),N+1+n,n+1];
end
```

Define the lower and vertical bars.

```
for n = 1:N-1
    lelem = L/N;
    bars(2*N+n,:) = [lelem,0,N+1+n,N+1+n+1];
    lelem = H;
    bars(2*N+N-1+n,:) = [lelem,pi/2,N+1+n+1,n+1];
end
```

Assemble Bars into Symbolic Global Matrices

The truss structure has seven nodes. Each node has two degrees of freedom (horizontal and vertical displacements). The total number of degrees of freedom in this system is 14.

```
numDofs = 2*2*(N+1)-2
```

```
numDofs = 14
```

The system mass matrix M and system stiffness matrix K are symbolic matrices. Assemble local element matrices from each bar into the corresponding global matrix.

```

K = sym(zeros(numDofs,numDofs));
M = sym(zeros(numDofs,numDofs));
for j = 1:size(bars,1)
    % Construct stiffness and mass matrices for bar j.
    lelem = bars(j,1); telem = bars(j,2);
    kelem = localStiffnessFn(telem,lelem,Eval);
    melem = localMassFn(telem,lelem,rhoval);
    n1 = bars(j,3); n2 = bars(j,4);
    % For bars that are not within the parameterized area A, set the stiffness
    % and mass matrices to numeric values. Note that although the values
    % kelem and melem do not have symbolic parameters, they are still
    % symbolic objects (symbolic numbers).
    if j ~= N+1
        kelem = subs(kelem,A,AFixed);
        melem = subs(melem,A,AFixed);
    end
    % Arrange the indices.
    ix = [n1*2-1,n1*2,n2*2-1,n2*2];
    % Embed local elements in system global matrices.
    K(ix,ix) = K(ix,ix) + kelem;
    M(ix,ix) = M(ix,ix) + melem;
end
end

```

Eliminate degrees of freedom attached to the wall.

```

wallDofs = [1,2,2*(N+1)+1,2*(N+1)+2]; % DoFs to eliminate
K(wallDofs,:) = [];
K(:,wallDofs) = [];
M(wallDofs,:) = [];
M(:,wallDofs) = [];

```

F is the load vector with a load specified in the negative Y direction at the upper rightmost joint.

```

F = zeros(size(K,1),1);
F(2*N) = -1;

```

To extract the Y displacement at the upper rightmost joint, create a selection vector.

```

c = zeros(1,size(K,1));
c(2*N) = 1;

```

Create Simscape Equations from Exact Symbolic Solution for Static Case

Find and plot the analytical solution for the displacement d as a function of A . Here, $K \setminus F$ represents the displacements at all joints and c selects the particular displacements. First, show the symbolic solution representing numeric values using 16 digits for compactness.

```

d_Static = simplify(c*(K\F));
vpa(d_Static,16)

```

```

ans =
-----
0.00000001118033988749895 (504.7737197247586 A2 + 384.7213595499958 A + 22.3606797749979)
-----
A (1.28 A + 0.8944271909999158)

```

```

fplot(d_Static,[AFixed/10,10*AFixed]);
hold on;
xlabel('Cross-Section, A');

```

```
ylabel('Displacement, d');
title('')
```

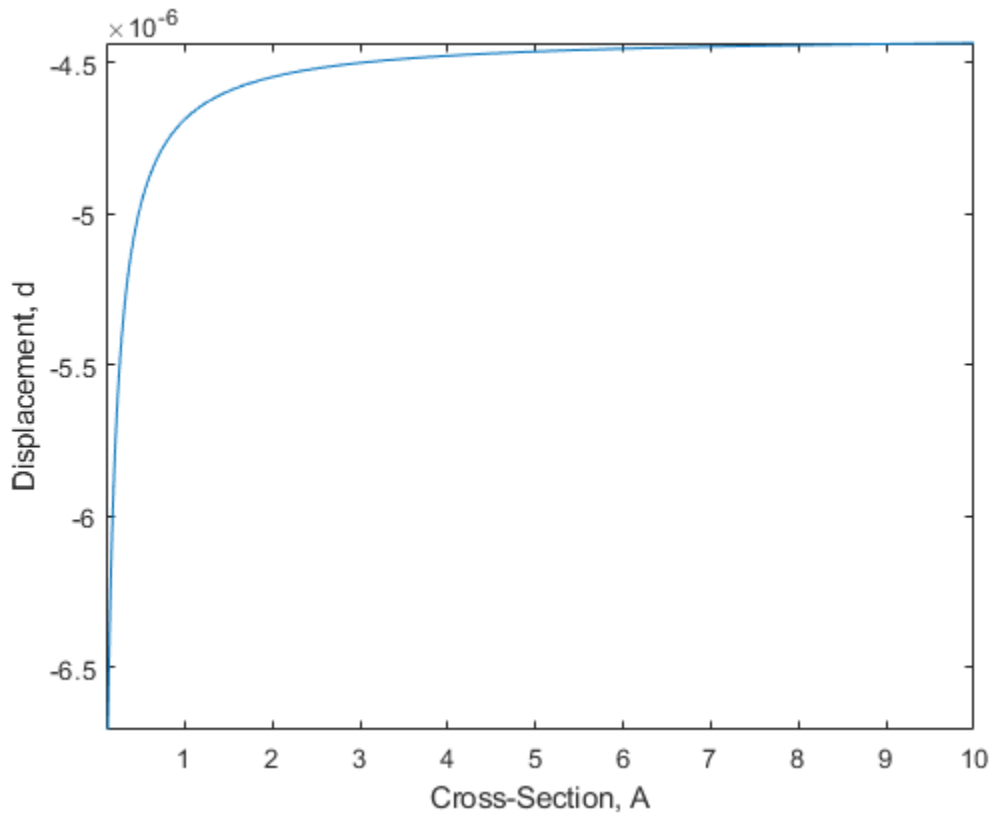

Convert the result to a Simscape equation `ssEq` to use inside a Simscape block. To display the resulting Simscape equation, remove the semicolon.

```
syms d
ssEq = simscapeEquation(d,d_Static);
```

Display the first 120 characters of the expression for `ssEq`.

```
strcat(ssEq(1:120), '...')
```

```
ans =
'd == (sqrt(5.0)*(A*2.2e+2+A*cos(9.272952180016122e-1))*2.0e+2+sqrt(5.0)*A^2*1.16e+2+sqrt(5.0)*1.0
```

Compare Numeric and Symbolic Static Solutions

Compare the exact analytical solution and numeric solution over a range of `A` parameter values. The values form a sequence from `AFixed` to `5*AFixed` in increments of 1.

```
AParamValues = AFixed*(1:5)';
d_NumericArray = zeros(size(AParamValues));
for k=1:numel(AParamValues)
    beginDim = (k-1)*size(K,1)+1;
    endDim = k*size(K,1);
    % Create a numeric stiffness matrix and extract the numeric solution.
    KNumeric = double(subs(K,A,AParamValues(k)));
```

```
d_NumericArray(k) = c*(KNumeric\F);
end
```

Compute the symbolic values over `AParamValues`. To do so, call the `subs` function, and then convert the result to double-precision numbers using `double`.

```
d_SymArray = double(subs(d_Static,A,AParamValues));
```

Visualize the data in a table.

```
T = table(AParamValues,d_SymArray,d_NumericArray)
```

```
T=5x3 table
  AParamValues  d_SymArray  d_NumericArray
  _____  _____  _____
           1  -4.6885e-06  -4.6885e-06
           2  -4.5488e-06  -4.5488e-06
           3  -4.5022e-06  -4.5022e-06
           4  -4.4789e-06  -4.4789e-06
           5  -4.4649e-06  -4.4649e-06
```

Approximate Parametric Symbolic Solution for Frequency Response

A parametric representation for the frequency response $H(s, A)$ can be efficient for quickly examining the effects of parameter A without resorting to potentially expensive numeric calculations for each new value of A . However, finding an exact closed-form solution for a large system with additional parameters is often impossible. Therefore, you typically approximate a solution for such systems. This example approximates the parametric frequency response near the zero frequency as follows:

- Speed up computations by using variable-precision arithmetic (`vpa`).
- Find the Padé approximation of the transfer function $H(s, A) = c(s^2M(A) + K(A))^{-1}F$ around the frequency $s = 0$ using the first three moments of the series. The idea is that given a transfer function, you can compute the Padé approximation moments as $c(-K(A)^{-1}M(A))^jK(A)^{-1}F$, where $j \in \{0, 2, 4, 6, \dots\}$ correspond to the power series terms $\{1, s^2, s^4, s^6, \dots\}$. For this example, compute `HApprox(s, A)` as the sum of the first three terms. This approach is a very basic technique for reducing the order of the transfer function.
- To further speed up calculations, approximate the inner term of each moment term in terms of a Taylor series expansion of A around `AFixed`.

Use `vpa` to speed up calculations.

```
digits(32);
K = vpa(K);
M = vpa(M);
```

Compute the LU decomposition of K .

```
[LK,UK] = lu(K);
```

Create helper variables and functions.

```
iK = @(x) UK\(LK\x);
iK_M = @(x) -iK(M*x);
momentPre = iK(F);
```

Define a frequency series corresponding to the first three moments. Here, s is the frequency.

```
syms s
sPowers = [1 s^2 s^4];
```

Set the first moment, which is the same as `d_Static` in the previous computation.

```
moments = d_Static;
```

Compute the remaining moments.

```
for p=2:numel(sPowers)
    momentPre = iK_M(momentPre);
    for pp=1:numel(momentPre)
        momentPre(pp) = taylor(momentPre(pp),A,AFixed,'Order',3);
    end
    moment = c*momentPre;
    moments = [moments;moment];
end
```

Combine the moment terms to create the approximate analytical frequency response `HApprox`.

```
HApprox = sPowers*moments;
```

Display the first three moments. Because the expressions are large, you can display them only partially.

```
momentString = arrayfun(@char,moments,'UniformOutput',false);
freqString = arrayfun(@char,sPowers.','UniformOutput',false);
table(freqString,momentString,'VariableNames',{'FreqPowers','Moments'})
```

```
ans=3x2 table
    FreqPowers
```

{'1' }	{'- (5^(1/2))*(220*A + 200*A*cos(8352332796509007/9007199254740992) + 116*5^(1/2)
{'s^2' }	{'0.000000000084654421099019119162064316556812*(A - 1)^2 - 0.0000000007900124
{'s^4' }	{'0.000000000000012982169746567833536274593916742*A - 0.00000000000150071410

Convert the frequency response to a MATLAB function containing numeric values for A and s . You can use the resulting MATLAB function without Symbolic Math Toolbox.

```
HApproxFun = matlabFunction(HApprox,'vars',[A,s]);
```

Compare Purely Numeric and Symbolically Derived Frequency Responses

Vary the frequency from 0 to 1 in logspace, and then convert the range to radians.

```
freq = 2*pi*logspace(0,1);
```

Compute the numeric values of the frequency response for $A = A_{\text{Fixed}} * \text{perturbFactor}$, that is, for a small perturbation around A .

```
perturbFactor = 1 + 0.25;
KFixed = double(subs(K,A,AFixed*perturbFactor));
```

```

MFixed = double(subs(M,A,AFixed*perturbFactor));
H_Numeric = zeros(size(freq));
for k=1:numel(freq)
    sVal = 1i*freq(k);
    H_Numeric(k) = c*((sVal^2*MFixed + KFixed)\F);
end

```

Compute the symbolic values of the frequency response over the frequency range and $A = \text{perturbFactor} * A_{\text{Fixed}}$.

```
H_Symbolic = HApproxFun(AFixed*perturbFactor, freq*1i);
```

Plot the results.

```

figure
loglog(freq/(2*pi),abs(H_Symbolic),freq/(2*pi),abs(H_Numeric),'k*');
xlabel('Frequency');
ylabel('Frequency Response');
legend('Symbolic','Numeric');

```

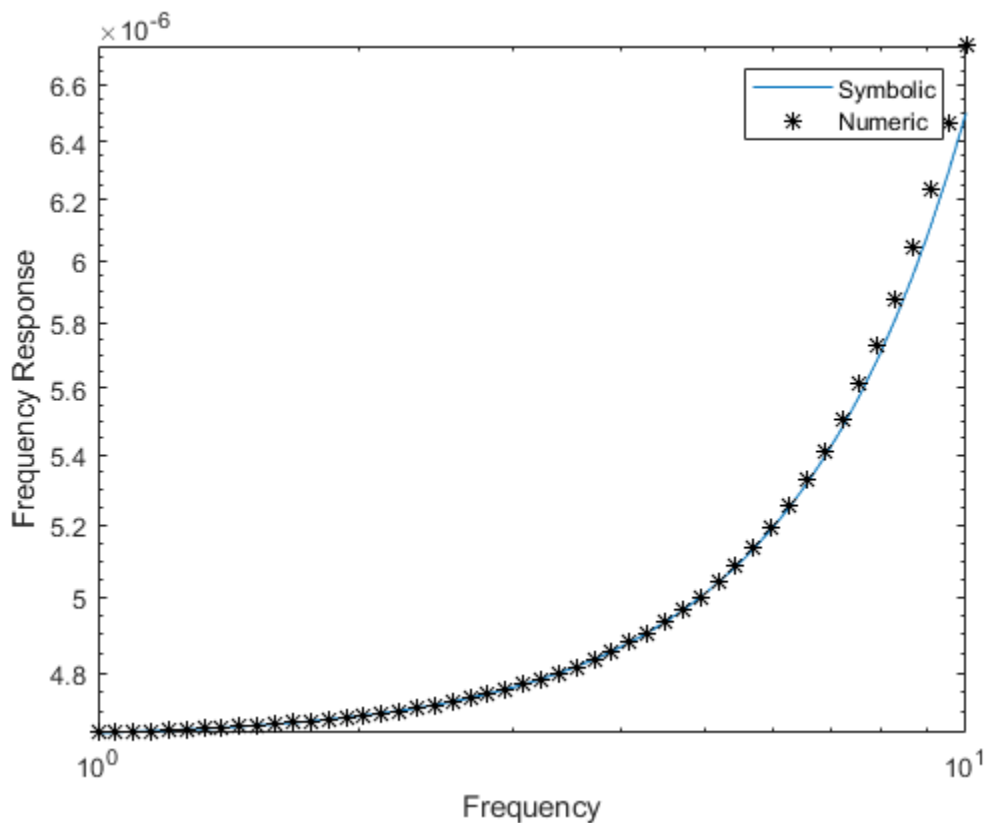

The analytical and numeric curves are close in the chosen interval, but, in general, the curves diverge for frequencies outside the neighborhood of $s = 0$. Also, for values of A far from A_{Fixed} , the Taylor approximation introduces larger errors.

Estimate Model Parameters of a Symbolically Derived Plant Model in Simulink

This example uses Simulink Design Optimization™ to estimate the unknown capacitance and initial voltage of a symbolically derived algebraic model of a simple resistor-capacitor (RC) circuit. The example solves the same problem and uses the same experimental data as Estimate Model Parameters and Initial States, but uses the closed-form solution for the RC circuit instead of the differential form.

This example uses Symbolic Math Toolbox™ capabilities to:

- Solve ordinary differential equations (ODE) using `dsolve`
- Convert an analytical result into a Simulink block using `matlabFunctionBlock`

You perform design optimization to estimate the capacitance and initial voltage values of the analytical RC circuit. In particular, you match the experimental output voltage values with the simulated values.

Solve Equation for RC Circuit

Define and solve the following differential equation for the RC circuit.

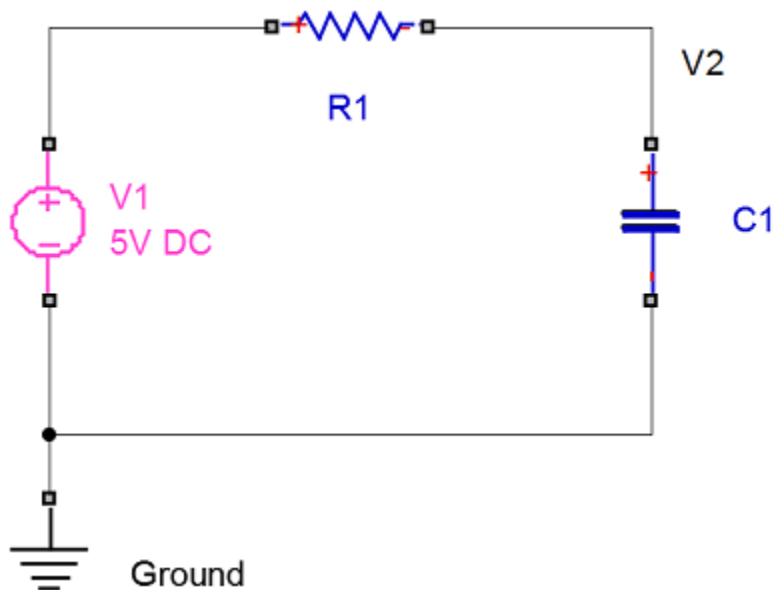

Here, $v_2(t)$ is the output voltage across capacitor C1, v_1 is the constant voltage across resistor R1, and v_{20} is the initial voltage across the capacitor. Use `dsolve` to solve the equation.

```
syms C1 R1 v1 v20 real
syms v2(t)
deq = (v1 - v2)/R1 - C1*diff(v2,t);
v2sol = dsolve(deq, v2(0) == v20)
```

```
v2sol =
v1 - e- $\frac{t}{C_1 R_1}$  (v1 - v20)
```

Use `subs` to evaluate the solution for an R_1 value of 10 kOhm and v_1 value of 5 V.

```
v2sol = vpa(subs(v2sol,[R1,v1],[10e3,5]))
```

```
v2sol =
    e- $\frac{0.0001t}{C_1}$  (v20 - 5.0) + 5.0
```

Create Model with Block Representing RC Circuit

First, create a new Simulink model.

```
myModel = 'rcSymbolic';
new_system(myModel);
load_system(myModel);
```

Use `matlabFunctionBlock` to convert the symbolic result for the output voltage to a Simulink block representing the RC plant model. `matlabFunctionBlock` adds this new block to the model.

```
blockName = 'closedFormRC_block';
rcBlock = strcat(myModel,'/',blockName);
myVars = [C1,v20,t];
matlabFunctionBlock(rcBlock,v2sol,...
    'vars',myVars,...
    'functionName','myRC',...
    'outputs',{'v2'});
```

Add More Blocks

Add and arrange other blocks with positions and sizes relative to the RC block.

```
rcBlockPosition = get_param(rcBlock,'position');
rcBlockWidth = rcBlockPosition(3)-rcBlockPosition(1);
rcBlockHeight = rcBlockPosition(4)-rcBlockPosition(2);
constantBlock = 'built-in/Constant';
timeBlock = 'simulink/Sources/Ramp';
outputBlock = 'built-in/Output';
```

C_1 and v_{20} are the parameters to estimate. First, introduce and initialize these parameters in the MATLAB workspace, using the initial values of 460 μF and 1 V, respectively. Then create constant blocks for both parameters.

```
C1val = 460e-6;
v20val = 1.0;
posX = rcBlockPosition(1)-rcBlockWidth*2;
posY = rcBlockPosition(2)-rcBlockHeight*3/4;
pos = [posX,posY,posX+rcBlockWidth/2,posY+rcBlockHeight/2];
add_block(constantBlock,strcat(myModel,'/C1'),'Value','C1val',...
    'Position',pos);
pos = pos + [0 rcBlockHeight 0 rcBlockHeight];
add_block(constantBlock,strcat(myModel,'/v20'),'Value','v20val',...
    'Position',pos);
```

Add a ramp for time.

```
pos = pos + [0 rcBlockHeight 0 rcBlockHeight];
add_block(timeBlock,strcat(myModel,'/t'),'Slope','1','Position',pos);
```

Add an output port.

```
pos = [rcBlockPosition(1)+2*rcBlockWidth,...
      rcBlockPosition(2)+rcBlockHeight/4,...
      rcBlockPosition(1)+2*rcBlockWidth+rcBlockWidth/2,...
      rcBlockPosition(2)+rcBlockHeight/4+rcBlockHeight/2];
add_block(outputBlock, strcat(myModel, '/v2'), 'Port', '1', 'Position', pos);
```

Now, wire blocks in the model. The model is ready for Simulink Design Optimization.

```
myAddLine = @(k) add_line(myModel,...
    strcat(char(myVars(k)), '/1'),...
    strcat(blockName, '/', num2str(k)),...
    'autorouting', 'on');
arrayfun(myAddLine, (1: numel(myVars)));
add_line(myModel, strcat(blockName, '/1'), 'v2/1', 'autorouting', 'on');
open_system(myModel);
```

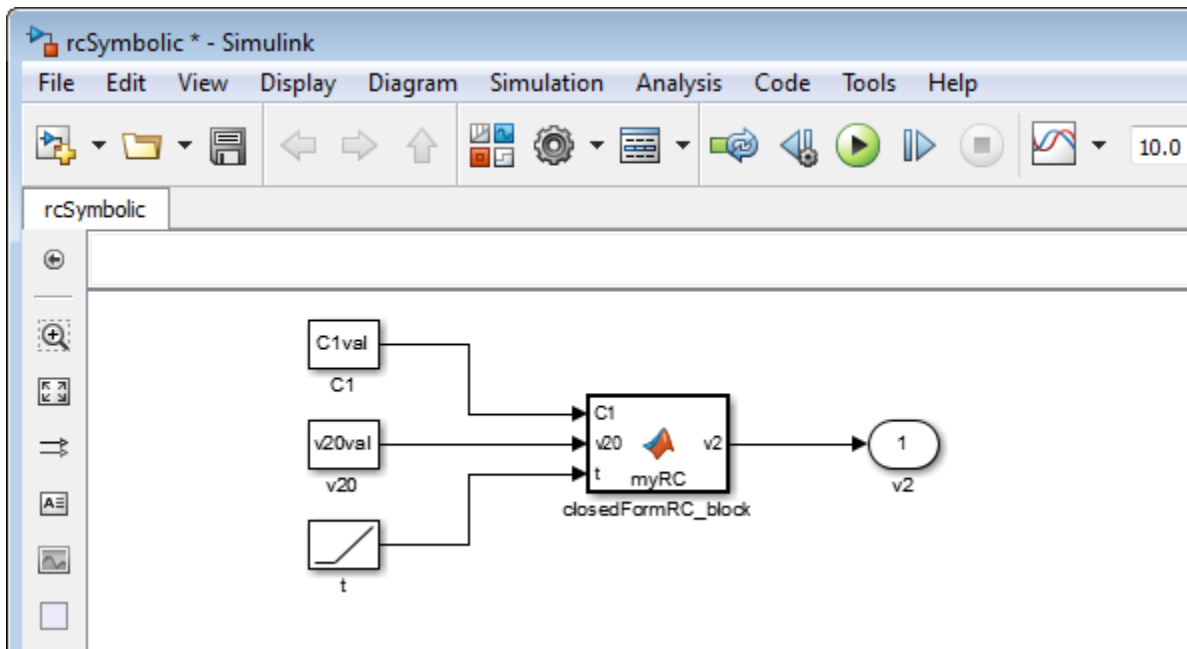

Estimate Parameters

Get the measured data.

```
load sdoRCCircuit_ExperimentData
```

The variables `time` and `data` are loaded into the workspace. `data` is the measured capacitor voltage for times `time`.

Create an `sdo.Experiment` object to store the experimental voltage data.

```
Exp = sdo.Experiment(myModel);
```

Create an object to store the measured capacitor voltage output.

```
Voltage = Simulink.SimulationData.Signal;
Voltage.Name = 'Voltage';
Voltage.BlockPath = rcBlock;
Voltage.PortType = 'outport';
```

```
Voltage.PortIndex = 1;
Voltage.Values     = timeseries(data,time);
```

Add the measured capacitor data to the experiment as the expected output data.

```
Exp.OutputData = Voltage;
```

Get the parameters. Set a minimum value for C1. Note that you already specified the initial guesses.

```
c1param = sdo.getParameterFromModel(myModel, 'C1val');
c1param.Minimum = 0;
v20param = sdo.getParameterFromModel(myModel, 'v20val');
```

Define the objective function for estimation. The code for `sdoRCSymbolic_Objective` used in this example is given in the Helper Functions section at the end of the example.

```
estFcn = @(v) sdoRCSymbolic_Objective(v,Exp,myModel);
```

Collect the model parameters to be estimated.

```
v = [c1param;v20param];
```

Because the model is entirely algebraic, turn off warning messages that instruct you to select a discrete solver.

```
set_param(myModel, 'SolverPrmCheckMsg', 'none');
```

Estimate the parameters.

```
opt = sdo.OptimizeOptions;
opt.Method = 'lsqnonlin';
v0pt = sdo.optimize(estFcn,v,opt);
```

```
Optimization started 29-Feb-2020 14:38:30
```

Iter	F-count	f(x)	Step-size	First-order optimality
0	5	27.7093	1	
1	10	2.86889	1.919	2.94
2	15	1.53851	0.3832	0.523
3	20	1.35137	0.3347	0.505
4	25	1.34473	0.01374	0.00842
5	30	1.34472	0.002686	0.00141

Local minimum possible.

`lsqnonlin` stopped because the final change in the sum of squares relative to its initial value is less than the value of the function tolerance.

Show the estimated values.

```
fprintf('C1 = %e v20 = %e\n',v0pt(1).Value, v0pt(2).Value);
```

```
C1 = 2.261442e-04 v20 = 2.359446e+00
```

Compare Simulated and Experimental Data

Update the experiment with the estimated capacitance and capacitor initial voltage values.

```
Exp = setEstimatedValues(Exp,v0pt);
```

Simulate the model with the estimated parameter values and compare the simulated output with the experimental data.

```

Simulator = createSimulator(Exp);
Simulator = sim(Simulator);
SimLog    = find(Simulator.LoggedData,get_param(myModel,'SignalLoggingName'));
Voltage   = find(SimLog,'Voltage');
plot(time,data,'ro',Voltage.Values.Time,Voltage.Values.Data,'b')
title('Simulated and Measured Responses')
legend('Measured Voltage','Simulated Voltage','Location','Best')

```

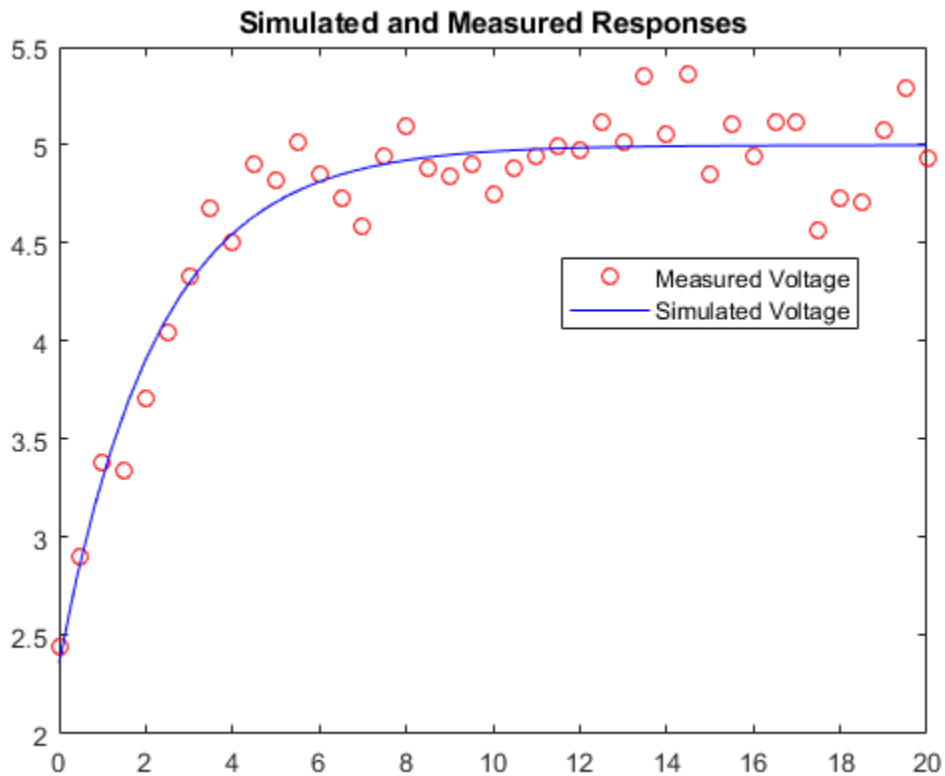

```
close_system(myModel,0);
```

Helper Functions

```

function vals = sdoRCSymbolic_Objective(v,Exp,myModel)
    r = sdo.requirements.SignalTracking;
    r.Type      = '==';
    r.Method    = 'Residuals';
    r.Normalize = 'off';
    Exp = setEstimatedValues(Exp,v);
    Simulator = createSimulator(Exp);
    Simulator = sim(Simulator);
    SimLog    = find(Simulator.LoggedData,get_param(myModel,'SignalLoggingName'));
    Voltage   = find(SimLog,'Voltage');
    VoltageError = evalRequirement(r,Voltage.Values,Exp.OutputData(1).Values);

```

```
    vals.F = VoltageError(:);  
end
```

Generate C or Fortran Code from Symbolic Expressions

You can generate C or Fortran code fragments from a symbolic expression, or generate files containing code fragments, using the `ccode` and `fortran` functions. These code fragments calculate numerical values as if substituting numbers for variables in the symbolic expression.

To generate code from a symbolic expression `g`, enter either `ccode(g)` or `fortran(g)`.

For example:

```
syms x y
z = 30*x^4/(x*y^2 + 10) - x^3*(y^2 + 1)^2;
fortran(z)
```

```
ans =
'      t0 = (x**4*3.0D+1)/(x*y**2+1.0D+1)-x**3*(y**2+1.0D0)**2'
```

```
ccode(z)
```

```
ans =
'      t0 = ((x*x*x*x)*3.0E+1)/(x*(y*y)+1.0E+1)-(x*x*x)*pow(y*y+1.0,2.0);'
```

To generate a file containing code, either enter `ccode(g, 'file', 'filename')` or `fortran(g, 'file', 'filename')`. For the example above,

```
fortran(z, 'file', 'fortrantest')
```

generates a file named `fortrantest` in the current folder. `fortrantest` consists of the following:

```
t2 = y**2
t0 = (x**4*3.0D+1)/(t2*x+1.0D+1)-x**3*(t2+1.0D0)**2
```

Similarly, the command

```
ccode(z, 'file', 'ccodetest')
```

generates a file named `ccodetest` that consists of the lines

```
t2 = y*y;
t0 = ((x*x*x*x)*3.0E+1)/(t2*x+1.0E+1)-(x*x*x)*pow(t2+1.0,2.0);
```

`ccode` and `fortran` generate many intermediate variables. This is called *optimized* code. MATLAB generates intermediate variables as a lowercase letter `t` followed by an automatically generated number, such as `t2`. Intermediate variables can make the resulting code more efficient by reusing intermediate expressions (such as `t2` in `fortrantest` and `ccodetest`). They can also make the code easier to read by keeping expressions short.

Generate MATLAB Functions from Symbolic Expressions

You can use `matlabFunction` to generate a MATLAB function handle that calculates numerical values as if you were substituting numbers for variables in a symbolic expression. Also, `matlabFunction` can create a file that accepts numeric arguments and evaluates the symbolic expression applied to the arguments. The generated file is available for use in any MATLAB calculation, whether or not the computer running the file has a license for Symbolic Math Toolbox functions.

Generating a Function Handle

`matlabFunction` can generate a function handle from any symbolic expression. For example:

```
syms x y
r = sqrt(x^2 + y^2);
ht = matlabFunction(tanh(r))

ht =
    function_handle with value:
    @(x,y)tanh(sqrt(x.^2+y.^2))
```

You can use this function handle to calculate numerically:

```
ht(.5,.5)

ans =
    0.6089
```

You can pass the usual MATLAB double-precision numbers or matrices to the function handle. For example:

```
cc = [.5,3];
dd = [-.5,.5];
ht(cc, dd)

ans =
    0.6089    0.9954
```

Tip Some symbolic expressions cannot be represented using MATLAB functions. `matlabFunction` cannot convert these symbolic expressions, but issues a warning. Since these expressions might result in undefined function calls, always check conversion results and verify the results by executing the resulting function.

Control the Order of Variables

`matlabFunction` generates input variables in alphabetical order from a symbolic expression. That is why the function handle in “Generating a Function Handle” on page 2-267 has `x` before `y`:

```
ht = @(x,y)tanh((x.^2 + y.^2).^(1./2))
```

You can specify the order of input variables in the function handle using the `vars` option. You specify the order by passing a cell array of character vectors or symbolic arrays, or a vector of symbolic variables. For example:

```

syms x y z
r = sqrt(x^2 + 3*y^2 + 5*z^2);
ht1 = matlabFunction(tanh(r), 'vars', [y x z])

ht1 =
    function_handle with value:
        @(y,x,z)tanh(sqrt(x.^2+y.^2.*3.0+z.^2.*5.0))

ht2 = matlabFunction(tanh(r), 'vars', {'x', 'y', 'z'})

ht2 =
    function_handle with value:
        @(x,y,z)tanh(sqrt(x.^2+y.^2.*3.0+z.^2.*5.0))

ht3 = matlabFunction(tanh(r), 'vars', {'x', [y z]})

ht3 =
    function_handle with value:
        @(x,in2)tanh(sqrt(x.^2+in2(:,1).^2.*3.0+in2(:,2).^2.*5.0))

```

Generate a File

You can generate a file from a symbolic expression, in addition to a function handle. Specify the file name using the `file` option. Pass a character vector containing the file name or the path to the file. If you do not specify the path to the file, `matlabFunction` creates this file in the current folder.

This example generates a file that calculates the value of the symbolic matrix `F` for double-precision inputs `t`, `x`, and `y`:

```

syms x y t
z = (x^3 - tan(y))/(x^3 + tan(y));
w = z/(1 + t^2);
F = [w, (1 + t^2)*x/y; (1 + t^2)*x/y, 3*z - 1];
matlabFunction(F, 'file', 'testMatrix.m')

```

The file `testMatrix.m` contains the following code:

```

function F = testMatrix(t,x,y)
%TESTMATRIX
%   F = TESTMATRIX(T,X,Y)

t2 = x.^2;
t3 = tan(y);
t4 = t2.*x;
t5 = t.^2;
t6 = t5 + 1;
t7 = 1./y;
t8 = t6.*t7.*x;
t9 = t3 + t4;
t10 = 1./t9;
F = [-(t10.*(t3 - t4))./t6,t8; t8,- t10.*(3.*t3 - 3.*t2.*x) - 1];

```

`matlabFunction` generates many intermediate variables. This is called *optimized* code. MATLAB generates intermediate variables as a lowercase letter `t` followed by an automatically generated number, for example `t32`. Intermediate variables can make the resulting code more efficient by reusing intermediate expressions (such as `t4`, `t6`, `t8`, `t9`, and `t10` in the calculation of `F`). Using intermediate variables can make the code easier to read by keeping expressions short.

If you don't want the default alphabetical order of input variables, use the `vars` option to control the order. Continuing the example,

```
matlabFunction(F, 'file', 'testMatrix.m', 'vars', [x y t])
```

generates a file equivalent to the previous one, with a different order of inputs:

```
function F = testMatrix(x,y,t)
...
```

Name Output Variables

By default, the names of the output variables coincide with the names you use calling `matlabFunction`. For example, if you call `matlabFunction` with the variable F

```
syms x y t
z = (x^3 - tan(y))/(x^3 + tan(y));
w = z/(1 + t^2);
F = [w, (1 + t^2)*x/y; (1 + t^2)*x/y, 3*z - 1];
matlabFunction(F, 'file', 'testMatrix.m', 'vars', [x y t])
```

the generated name of an output variable is also F :

```
function F = testMatrix(x,y,t)
...
```

If you call `matlabFunction` using an expression instead of individual variables

```
syms x y t
z = (x^3 - tan(y))/(x^3 + tan(y));
w = z/(1 + t^2);
F = [w, (1 + t^2)*x/y; (1 + t^2)*x/y, 3*z - 1];
matlabFunction(w + z + F, 'file', 'testMatrix.m', ...
'vars', [x y t])
```

the default names of output variables consist of the word `out` followed by the number, for example:

```
function out1 = testMatrix(x,y,t)
...
```

To customize the names of output variables, use the `output` option:

```
syms x y z
r = x^2 + y^2 + z^2;
q = x^2 - y^2 - z^2;
f = matlabFunction(r, q, 'file', 'new_function', ...
'outputs', {'name1', 'name2'})
```

The generated function returns *name1* and *name2* as results:

```
function [name1,name2] = new_function(x,y,z)
...
```

Generate MATLAB Function Blocks from Symbolic Expressions

Using `matlabFunctionBlock`, you can generate a MATLAB Function block. The generated block is available for use in Simulink models, whether or not the computer running the simulations has a license for Symbolic Math Toolbox.

Generate and Edit a Block

Suppose, you want to create a model involving the symbolic expression $r = \sqrt{x^2 + y^2}$. Before you can convert a symbolic expression to a MATLAB Function block, create an empty model or open an existing one:

```
new_system('my_system')
open_system('my_system')
```

Create a symbolic expression and pass it to the `matlabFunctionBlock` command. Also specify the block name:

```
syms x y
r = sqrt(x^2 + y^2);
matlabFunctionBlock('my_system/my_block', r)
```

If you use the name of an existing block, the `matlabFunctionBlock` command replaces the definition of an existing block with the converted symbolic expression.

You can open and edit the generated block. To open a block, double-click it.

```
function r = my_block(x,y)
%#codegen

r = sqrt(x.^2+y.^2);
```

Tip Some symbolic expressions cannot be represented using MATLAB functions. `matlabFunctionBlock` cannot convert these symbolic expressions, but issues a warning. Since these expressions might result in undefined function calls, always check conversion results and verify results by running the simulation containing the resulting block.

Control the Order of Input Ports

`matlabFunctionBlock` generates input variables and the corresponding input ports in alphabetical order from a symbolic expression. To change the order of input variables, use the `vars` option:

```
syms x y
mu = sym('mu');
dydt = -x - mu*y*(x^2 - 1);
matlabFunctionBlock('my_system/vdp', dydt, 'vars', [y mu x])
```

Name the Output Ports

By default, `matlabFunctionBlock` generates the names of the output ports as the word `out` followed by the output port number, for example, `out3`. The `output` option allows you to use the custom names of the output ports:

```
syms x y
mu = sym('mu');
dydt = -x - mu*y*(x^2 - 1);
matlabFunctionBlock('my_system/vdp', dydt, 'outputs', {'name1'})
```

Generate Simscape Equations from Symbolic Expressions

Simscape software extends the Simulink product line with tools for modeling and simulating multidomain physical systems, such as those with mechanical, hydraulic, pneumatic, thermal, and electrical components. Unlike other Simulink blocks, which represent mathematical operations or operate on signals, Simscape blocks represent physical components or relationships directly. With Simscape blocks, you build a model of a system just as you would assemble a physical system. For more information about Simscape software see “Simscape”.

You can extend the Simscape modeling environment by creating custom components. When you define a component, use the equation section of the component file to establish the mathematical relationships among a component's variables, parameters, inputs, outputs, time, and the time derivatives of each of these entities. The Symbolic Math Toolbox and Simscape software let you perform symbolic computations and use the results of these computations in the equation section. The `simscapeEquation` function translates the results of symbolic computations to Simscape language equations.

Convert Algebraic and Differential Equations

Suppose, you want to generate a Simscape equation from the solution of the following ordinary differential equation. As a first step, use the `dsolve` function to solve the equation:

```
syms a y(t)
Dy = diff(y);
s = dsolve(diff(y, 2) == -a^2*y, y(0) == 1, Dy(pi/a) == 0);
s = simplify(s)
```

The solution is:

```
s =
cos(a*t)
```

Then, use the `simscapeEquation` function to rewrite the solution in the Simscape language:

```
simscapeEquation(s)
```

`simscapeEquation` generates the following code:

```
ans =
's == cos(a*time);'
```

The variable *time* replaces all instances of the variable *t* except for derivatives with respect to *t*. To use the generated equation, copy the equation and paste it to the equation section of the Simscape component file. Do not copy the automatically generated variable `ans` and the equal sign that follows it.

`simscapeEquation` converts any derivative with respect to the variable *t* to the Simscape notation, *X*.der, where *X* is the time-dependent variable. For example, convert the following differential equation to a Simscape equation. Also, here you explicitly specify the left and the right sides of the equation by using the syntax `simscapeEquation(LHS, RHS)`:

```
syms a x(t)
simscapeEquation(diff(x), -a^2*x)

ans =
'x.der == -a^2*x;'
```

`simscapeEquation` also translates piecewise expressions to the Simscape language. For example, the result of the following Fourier transform is a piecewise function:

```
syms v u x
assume(x, 'real')
f = exp(-x^2*abs(v))*sin(v)/v;
s = fourier(f, v, u)

s =
piecewise(x ~= 0, atan((u + 1)/x^2) - atan((u - 1)/x^2))
```

From this symbolic piecewise equation, `simscapeEquation` generates valid code for the equation section of a Simscape component file:

```
simscapeEquation(s)

ans =
    'if (x ~= 0.0)
        s == -atan(1.0/x^2*(u-1.0))+atan(1.0/x^2*(u+1.0));
    else
        s == NaN;
    end'
```

Clear the assumption that x is real by recreating it using `syms`:

```
syms x
```

Limitations

The equation section of a Simscape component file supports a limited number of functions. For details and the list of supported functions, see [Simscape equations](#). If a symbolic expression contains functions that are not supported by Simscape, then `simscapeEquation` cannot represent the symbolic expression as a Simscape equation and issues a warning instead. Always verify the conversion result. Expressions with infinities are prone to invalid conversion.

MuPAD to MATLAB Migration

- “MuPAD Engines and MATLAB Workspace” on page 3-2
- “Convert MuPAD Notebooks to MATLAB Live Scripts” on page 3-3
- “Troubleshoot MuPAD to MATLAB Translation Errors” on page 3-8
- “Troubleshoot MuPAD to MATLAB Translation Warnings” on page 3-15
- “Differences Between MATLAB and MuPAD Syntax” on page 3-20
- “Call Built-In MuPAD Functions from MATLAB” on page 3-22

MuPAD Engines and MATLAB Workspace

Note MuPAD notebook has been removed. Use MATLAB Live Editor instead.

To convert a MuPAD notebook file to a MATLAB live script file, see `convertMuPADNotebook`. MATLAB live scripts support most MuPAD functionality, although there are some differences. For more information, see “Convert MuPAD Notebooks to MATLAB Live Scripts” on page 3-3.

A MuPAD engine is a separate process that runs on your computer in addition to a MATLAB process. A MuPAD engine starts when you first call a function that needs a symbolic engine, such as `syms`. Symbolic Math Toolbox functions that use the symbolic engine use standard MATLAB syntax, such as `y = int(x^2)`.

Conceptually, each MuPAD notebook has its own symbolic engine, with an associated workspace. You can have any number of MuPAD notebooks open simultaneously.

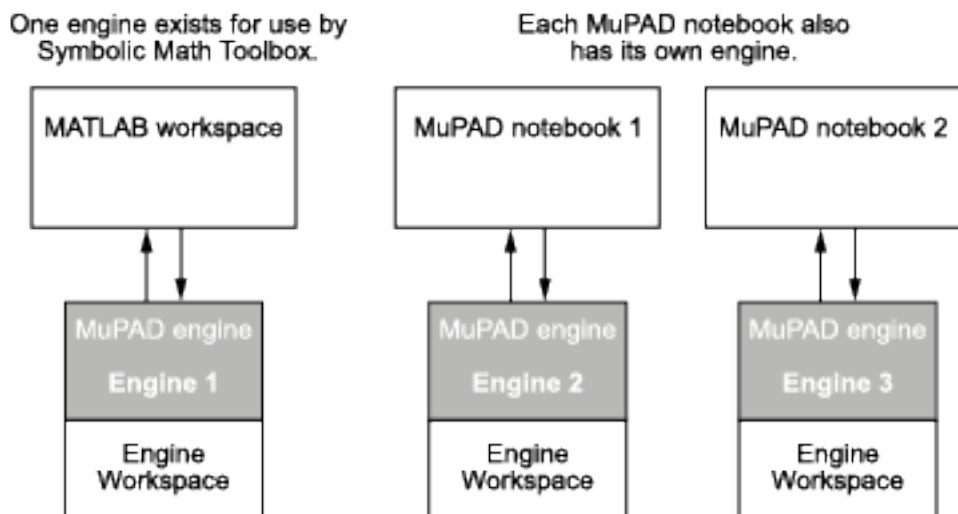

The engine workspace associated with the MATLAB workspace is generally empty, except for assumptions you make about variables. For details, see “Clear Assumptions and Reset the Symbolic Engine” on page 2-112.

Convert MuPAD Notebooks to MATLAB Live Scripts

Migrate MuPAD notebooks to MATLAB live scripts that use MATLAB code. Live scripts are an interactive way to run MATLAB code. For details, see “What Is a Live Script or Function?” (MATLAB). MuPAD notebooks are converted to live scripts by using Symbolic Math Toolbox. For more information, see “Get Started with Symbolic Math Toolbox”.

Convert a MuPAD Notebook .mn to a MATLAB Live Script .mlx

- 1 Prepare the notebook:** This step is optional, but helps avoid conversion errors and warnings. Check if your notebook contains untranslatable objects from “MuPAD Objects That Are Not Converted” on page 3-4. These objects cause translation errors or warnings.
- 2 Convert the notebook:** Use `convertMuPADNotebook`. For example, convert `myNotebook.mn` in the current folder to `myScript.mlx` in the same folder.

```
convertMuPADNotebook('myNotebook.mn', 'myScript.mlx')
```

Alternatively, right-click the notebook in the Current Folder browser and select **Open as Live Script**.

- 3 Check for errors or warnings:** Check the output of `convertMuPADNotebook` for errors or warnings. If there are none, go to step 7. For example, this output means that the converted live script `myScript.mlx` has 4 errors and 1 warning.

```
Created 'myScript.mlx': 4 translation errors, 1 warnings. For verifying...
the document, see help.
```

A translation error means that the translated code will not run correctly while a translation warning indicates that the code requires inspection. If the code only contains warnings, it will likely run without issues.

- 4 Fix translation errors:** Open the converted live script by clicking the link in the output. Find errors by searching for `ERROR`. The error explains which MuPAD command did not translate correctly. For details and fixes, click `ERROR`. After fixing the error, delete the error message. For the list of translation errors, see “Troubleshoot MuPAD to MATLAB Translation Errors” on page 3-8. If you cannot fix your error, and the “Known Issues” on page 3-4 do not help, please contact MathWorks Technical Support.
- 5 Fix translation warnings:** Find warnings by searching for `WARNING`. The warning text explains the issue. For details and fixes, click `WARNING`. Decide to either adapt the code or ignore the warning. Then delete the warning message. For the list of translation warnings, see “Troubleshoot MuPAD to MATLAB Translation Warnings” on page 3-15.
- 6 Verify the live script:** Open the live script and check for unexpected commands, comments, formatting, and so on. For readability, the converted code may require manual cleanup, such as eliminating auxiliary variables.
- 7 Execute the live script:** Ensure that the code runs properly and returns expected results. If the results are not expected, check your MuPAD code for the “Known Issues” on page 3-4 listed below.

Convert MuPAD Graphics to MATLAB Graphics

To convert MuPAD graphics, first try to convert the MuPAD plot commands that generated the graphics. This approach ensures you can control the graphical output in MATLAB similar to MuPAD.

If you cannot convert the MuPAD commands that produce graphics, then you can export the graphics into vector or bitmap formats.

Known Issues

These are the known issues when converting MuPAD notebooks to MATLAB live scripts with the `convertMuPADNotebook` function. If your issue is not described, please contact MathWorks Technical Support.

- “MuPAD Objects That Are Not Converted” on page 3-4
- “No Automatic Substitution in MATLAB” on page 3-4
- “last(1) in MuPAD Is Not ans in MATLAB” on page 3-5
- “Some solve Results Are Wrongly Accessed” on page 3-5
- “break Inside case Is Wrongly Translated” on page 3-5
- “Some MuPAD Graphics Options Are Not Translated” on page 3-6
- “Some Operations on Matrices Are Wrongly Translated” on page 3-6
- “indets Behavior in MATLAB Differs” on page 3-6
- “Return Type of factor Differs in MATLAB” on page 3-6
- “Layout Issues” on page 3-7
- “Syntax Differences Between MATLAB and MuPAD” on page 3-7

MuPAD Objects That Are Not Converted

Expand the list to view MuPAD objects that are not converted. To avoid conversion errors and warnings, remove these objects or commands from your notebook before conversion.

Objects Not Converted

- Reading code from files. Replace commands such as `read("filename.mu")` by the content of `filename.mu`.
- Function calls with expression sequences as input arguments.
- Function calls where the function is generated by the preceding code instead of being specified explicitly.
- Domains, and commands that create domains and their elements.
- Assignments to slots of domains and function environments.
- Commands using the history mechanism, such as `last(2)` or `HISTORY := 30`.
- MuPAD environment variables, such as `ORDER`, `HISTORY`, and `LEVEL`.

No Automatic Substitution in MATLAB

In MATLAB, when symbolic variables are assigned values, then expressions containing those values are not automatically updated.

Fixing This Issue

When values are assigned to variables, update any expressions that contain those variables by calling `subs` on those expressions.

```

syms a b
f = a + b;
a = 1;
b = 2;
f          % f is still a + b
subs(f)    % f is updated

f =
a + b
ans =
3

```

last(1) in MuPAD Is Not ans in MATLAB

In MuPAD, `last(1)` always returns the last result. In MATLAB, `ans` returns the result of the last *unassigned* command. For example, in MATLAB if you run `x = 1`, then calling `ans` does not return 1.

Fixing This Issue

Instead of using `ans`, assign the result to a variable and use that variable.

Some solve Results Are Wrongly Accessed

When results of MuPAD `solve` are accessed, `convertMuPADNotebook` assumes that the result is a finite set. However, if the result is a non-finite set then the code is wrongly translated.

Fixing This Issue

There is no general solution. Further, non-finite solution sets are not translatable.

If you are accessing parameters or conditions, use the `parameters` or `conditions` output arguments of MATLAB `solve`.

```

syms x
S = solve(sin(x) == 1, x, 'ReturnConditions', true);
S.x          % solution
S.parameters % parameters in solution
S.conditions % conditions on solution

ans =
pi/2 + 2*pi*k
ans =
k
ans =
in(k, 'integer')

```

break Inside case Is Wrongly Translated

In MuPAD, a `break` ends a case in a switch case. However, MATLAB does not require a `break` to end a case. Thus, a MuPAD `break` introduces an unnecessary `break` in MATLAB. Also, if a MuPAD case omits a `break`, then the MATLAB case will not fall-through.

Fixing This Issue

In the live script, delete `break` statements that end cases in a switch-case statement.

For fall-through in MATLAB, specify all values with their conditions in one case.

Some MuPAD Graphics Options Are Not Translated

While the most commonly used MuPAD graphics options are translated, there are some options that are not translated.

Fixing This Issue

Find the corresponding option in MATLAB by using the properties of the figure handle `gcf` or axis handle `gca`. For example, the MuPAD command `plot(sin(x), Width = 80*unit::mm, Height = 4*unit::cm)` sets height and width. Translate it to MATLAB code.

```
syms x
fplot(sin(x));
g = gcf;
g.Units = 'centimeters';
g.Position(3:4) = [8 4];
```

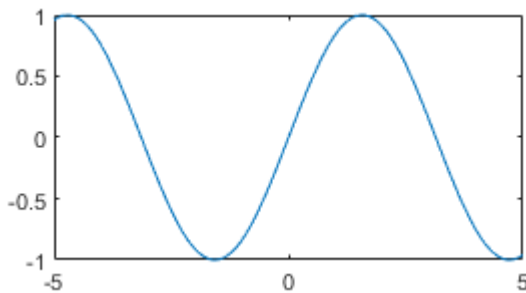

Some Operations on Matrices Are Wrongly Translated

Operations on matrices are not always translated correctly. For example, if M is a matrix, then `exp(M)` in MuPAD is wrongly translated to `exp(M)` instead of the matrix exponential `expm(M)`.

Fixing This Issue

When performing operations on matrices, search for the matrix operation and use it instead. For example, in MATLAB:

- Use `expm` instead of `exp`.
- Use `funm(M, 'sin')` instead of `sin(M)`.
- `A == [1 2; 3 4]` displays differently from `A = matrix([[1, 2], [3, 4]])` in MuPAD but is programmatically equivalent.

indets Behavior in MATLAB Differs

`indets` is translated to MATLAB `symvar`. However, `symvar` does not find bound variables or constant identifiers like `PI` in MuPAD.

Return Type of factor Differs in MATLAB

The return type of MuPAD `factor` has no equivalent in MATLAB. Subsequent operations on the results of `factor` in MATLAB might return incorrect results.

Fixing This Issue

Check and modify the output of `factor` in MATLAB as required such that subsequent commands run correctly.

Layout Issues

- MuPAD notebook frames are not converted.
- MuPAD notebook tables are not converted.
- MuPAD plots are not interactive in live scripts.
- Titles or headings in MuPAD notebooks are not always detected.
- MuPAD text attribute `underline` is not converted
- Text formatting: Font, font size, and color are not converted. All text in live scripts looks the same.

Syntax Differences Between MATLAB and MuPAD

For the syntax differences between MATLAB and MuPAD, see “Differences Between MATLAB and MuPAD Syntax” on page 3-20.

Troubleshoot MuPAD to MATLAB Translation Errors

This page helps troubleshoot errors generated by the `convertMuPADNotebook` function when converting MuPAD notebooks to MATLAB live scripts. For the conversion steps, see “Convert MuPAD Notebooks to MATLAB Live Scripts” on page 3-3. To troubleshoot warnings, see “Troubleshoot MuPAD to MATLAB Translation Warnings” on page 3-15.

Error Message	Details	Recommendations
No equivalent code in MATLAB.	<code>convertMuPADNotebook</code> cannot find the corresponding functionality in MATLAB.	Adjust the code so that it uses only the functionality that can be expressed in the MATLAB language. Alternatively, in the target <code>.mlx</code> file, some functionality can be replaced with MATLAB functionality, such as in statistics or file input-output.
Unable to translate the second and higher derivatives of Airy functions. Express these derivatives in terms of Airy functions and their first derivatives.	The MATLAB <code>airy</code> function represents Airy functions of the first and second kind and their first derivatives. In MuPAD, <code>airyAi(z,n)</code> and <code>airyBi(z,n)</code> can represent second and higher derivatives of Airy functions, that is, n can be greater than 1.	Rewrite second and higher derivatives of Airy functions in terms of Airy functions and their first derivatives. Then convert the result to MATLAB code. The MuPAD <code>airyAi</code> and <code>airyBi</code> functions return results in terms of Airy functions and their first derivatives. You can replace second and higher derivatives by their outputs in MuPAD, before converting the code to MATLAB.
Unable to translate assignment to MuPAD environment variable.	Environment variables are global variables, such as <code>HISTORY</code> , <code>LEVEL</code> , <code>ORDER</code> , and so on, that affect the behavior of MuPAD algorithms.	In some cases, you can use name-value pair arguments in each function call, such as setting the value <code>Order</code> in the <code>taylor</code> function call. In other cases, there is no appropriate replacement. Adjust the code so that it does not require a global setting.

Error Message	Details	Recommendations
<p>Unable to translate assignments to the remember table of a procedure.</p>	<p>MuPAD uses <i>remember tables</i> to speed up computations, especially when you use recursive procedure calls. The system stores the arguments of a procedure call as indices of the remember table entries, and the corresponding results as values of these entries. When you call a procedure using the same arguments as in previous calls, MuPAD accesses the remember table of that procedure. If the remember table contains the entry with the required arguments, MuPAD returns the value of that entry.</p> <p>The remember tables created by the option <code>remember</code> or <code>prog::remember</code> are not available in MATLAB.</p>	<p>Adjust the code so that it does not use remember tables.</p>
<p>Unable to translate assignments to slots of domains and function environments.</p>	<p>In MuPAD, the <code>slot</code> function defines methods and entries of data types (domains) or for defining attributes of function environments (domain type <code>DOM_FUNC_ENV</code>). These methods and entries (slots) let you overload system functions by your own domains and function environments.</p> <p>Domains, function environments, and their slots are not available in MATLAB.</p>	<p>Adjust the code so that it does not use assignments to slots of domains and function environments.</p>
<p>Unable to translate explicitly given coefficient ring.</p>	<p>MuPAD lets you use special coefficient rings that cannot be represented by arithmetical expressions. Specifying coefficient rings of polynomials is not available in MATLAB.</p>	<p>Adjust the code so that it does not use polynomials over special rings.</p>
<p>Unable to translate <code>complexInfinity</code>.</p>	<p>MuPAD uses the value <code>complexInfinity</code>. This value is not available in MATLAB.</p>	<p>Adjust the code so that it does not use <code>complexInfinity</code>.</p>

Error Message	Details	Recommendations
Unable to translate MuPAD code because it uses an obsolete calling syntax.	MuPAD syntax has changed and the code uses obsolete syntax that is no longer supported.	Adjust the code so that it uses only the functionality that can be expressed in the MATLAB language and then run <code>convertMuPADNotebook</code> again.
Unable to translate a call to the function 'D' with more than one argument.	The indices in the first argument of D cannot be translated to variable names in MATLAB.	Use the MuPAD <code>diff</code> function instead of D.
Unable to translate MuPAD domains, or commands to create domains or their elements.	Domains represent data types in MuPAD. They are not available in MATLAB.	Adjust the code so that it does not create or explicitly use domains and their elements.
Unable to translate the MuPAD environment variable "{0}".	<p>Environment variables are global variables, such as HISTORY, LEVEL, ORDER, and so on, that affect the behavior of MuPAD algorithms.</p> <p><code>convertMuPADNotebook</code> cannot translate MuPAD environment variables because they are not available in MATLAB.</p>	Adjust the code so that it does not require accessing MuPAD environment variables.
Unable to translate function calls with expression sequences as input arguments.	<p>In MuPAD, a function call $f(x)$, where x is a sequence of n operands, resolves to a call with n arguments.</p> <p>MATLAB cannot resolve function calls with expression sequences to calls with multiple arguments.</p>	Adjust the code so that it does not contain function calls with expression sequences as input arguments.
Unable to translate infinite sets.	<p>MuPAD recognizes infinite sets. For example, the <code>solve</code> function in MuPAD can return a solution as an infinite set: <code>solve(sin(x*PI/2) = 0, x)</code> returns $\{2k k \in \mathbb{Z}\}$. You can create such sets by using <code>Dom::ImageSet</code>.</p> <p>MATLAB does not support infinite sets.</p>	Adjust the code so that it does not use infinite sets as inputs.

Error Message	Details	Recommendations
Unable to translate a call accessing previously computed results. The MATLAB <code>ans</code> function lets you access only the most recent result.	The MuPAD <code>last</code> function and its shortcut <code>%</code> typically let you access the last 20 commands stored in an internal MuPAD history table. In MATLAB, <code>ans</code> lets you access only one most recent command.	Adjust the code so that it uses assignments instead of relying on <code>last</code> or <code>%</code> .
Unable to translate the variable "{0}" representing a MuPAD library.	Libraries contain most of the MuPAD functionality. Each library includes a collection of functions for solving particular types of mathematical problems. While MuPAD library functions are translated to MATLAB code, the libraries themselves are not.	Adjust the code so that it does not use MuPAD library names as identifiers.
Unable to map a function to objects of this class.	Objects of this class do not have an equivalent representation in MATLAB. The mapping cannot be translated.	In the target <code>.mlx</code> file, implement the mapping by writing a loop.
Unable to translate this form of matrix definition.	MuPAD provides a few different approaches for creating a matrix. You can create a matrix from an array, list of elements, a nested list of rows, or a table. Also, you can create a matrix by specifying only the nonzero entries, such as <code>A[i1,j1] = value1</code> , <code>A[i2,j2] = value2</code> , and so on. Some of these approaches cannot be translated to MATLAB code.	Adjust the code so that it defines matrices by using an array, list of elements, or a nested list of rows.
Cannot translate division with respect to several variables.	Polynomial division with respect to several variables is not available in MATLAB.	Adjust the code so that it does not use polynomial division with respect to several variables.
Unable to translate nested indexed assignment.	Nested indexed assignment is not available in MATLAB.	Replace the nested indexed assignment with multiple assignments.
Unable to create a polynomial from a coefficient list.	Cannot translate polynomial creation from the given coefficient list.	Make the first argument to <code>poly</code> an arithmetical expression instead of a list.

Error Message	Details	Recommendations
Unable to translate nontrivial procedures.	<p>For code that you want to execute repeatedly, MuPAD lets you create procedures by using the <code>proc</code> command.</p> <p><code>convertMuPADNotebook</code> can translate simple procedures to anonymous functions. Simple procedures do not contain loops, assignments, multiple statements, or nested functions where the inner function accesses variables of the outer function.</p> <p>More complicated procedures cannot be translated to MATLAB code.</p>	Adjust the code so that it does not use complicated procedures.
Unable to translate the global table of properties.	<p><code>convertMuPADNotebook</code> cannot translate the MuPAD global table of properties, <code>PROPERTIES</code>, because this functionality is not available in MATLAB.</p>	Set assumptions as described in “Use Assumptions on Symbolic Variables” on page 1-24.
Unable to create random generators with individual seed values.	<p>MuPAD lets you set a separate seed value for each random number generator. MATLAB has one seed value for all random number generators. See <code>rng</code> for details.</p>	Adjust the code so that it does not rely on individual seed values for different random number generators.

Error Message	Details	Recommendations
Unable to translate target "{0}" for MATLAB function "rewrite".	<p>The MuPAD rewrite function can rewrite an expression in terms of the following targets: andor, arccos, arccosh, arccot, arccoth, arcsin, arcsinh, arctan, arctanh, arg, bernoulli, cos, cosh, cot, coth, diff, D, erf, erfc, erfi, exp, fact, gamma, harmonic, heaviside, inverf, inverfc, lambertW, ln, max, min, piecewise, psi, sign, sin, sincos, sinh, sinhcos, tan, tanh.</p> <p>The MATLAB rewrite function supports fewer targets: exp, log, sincos, sin, cos, tan, cot, sqrt, heaviside, asin, acos, atan, acot, sinh, cosh, tanh, coth, sinhcos, asinh, acosh, atanh, acoth, piecewise.</p>	Adjust the code so that it uses the target options available in MATLAB. If needed, use a sequence of function calls to rewrite with different target options.
Unable to translate slots of domains and function environments.	Slots and domains are not available in MATLAB.	Adjust the code so that it does not use slots or domains.
Unable to substitute only one occurrence of a subexpression.	Substituting only one occurrence of a subexpression is not available in MATLAB.	In the target .mlx file, break up the expression using the function children to get the subexpression, and then substitute for it using the function subs.
Syntax error in MuPAD code.	MuPAD code contains a syntax error, for example, a missing bracket.	Check and correct the MuPAD code that you are translating.
Test environment of MuPAD not available in MATLAB.	The MuPAD test environment is not available in MATLAB.	Adjust the code so that it does not use the MuPAD test environment.
Unknown domain or library "{0}".	Most likely, a custom domain or library is used and cannot be translated.	Check and correct the MuPAD code that you are translating.
Unknown MuPAD function "{0}".	The function is not available in MuPAD.	Check and correct the MuPAD code that you are translating.

Error Message	Details	Recommendations
Unable to translate calls to the function "{0}".	The function is a valid MuPAD function, but the function call is invalid. For example, the number of input arguments or types of arguments can be incorrect.	Check and correct the MuPAD code that you are translating.
Unable to translate calls to functions of the library "{0}".	The functions of this library are available in MuPAD, but there are no corresponding functions in MATLAB.	Adjust the code so that it does not use the functions of this library.
MuPAD function "{0}" cannot be converted to function handle.	The MuPAD function does not have an equivalent function handle in MATLAB.	Adjust the code to use a function that has an equivalent in MATLAB.
Unable to translate option "{0}".	Most likely, this option is available in MuPAD, but there are no corresponding options in MATLAB.	Adjust the code so that it does not use this option.
Unable to translate MuPAD code because it uses invalid calling syntax.	Most likely, the function call in the MuPAD code has an error.	Check and correct the MuPAD code that you are translating.

Troubleshoot MuPAD to MATLAB Translation Warnings

This page helps troubleshoot warnings generated by the `convertMuPADNotebook` function when converting MuPAD notebooks to MATLAB live scripts. For the conversion steps, see “Convert MuPAD Notebooks to MATLAB Live Scripts” on page 3-3. To troubleshoot errors, see “Troubleshoot MuPAD to MATLAB Translation Errors” on page 3-8.

Warning Message	Meaning	Recommendations
<p>Translating the <code>alias</code> function as an assignment, and the <code>unalias</code> function as deletion of an assignment.</p>	<p>The MuPAD <code>alias</code> and <code>unalias</code> function let you create and delete an alias (abbreviation) for any MuPAD object. For example, you can create an alias <code>d</code> for the <code>diff</code> function: <code>alias(d = diff)</code>.</p> <p>Creating aliases is not available in MATLAB. When translating a notebook file, <code>convertMuPADNotebook</code> replaces aliases with assignments.</p>	<p>Verify the resulting code. If you do not want a MuPAD alias to be converted to an assignment in MATLAB, adjust the code so that it does not use aliases.</p>
<p>Replacing animation by its last frame.</p>	<p>MuPAD animations cannot be correctly reproduced in MATLAB. When translating a notebook file, <code>convertMuPADNotebook</code> replaces an animation with a static image showing the last frame of the animation.</p>	<p>Verify the resulting code. The last frame might not be ideal for some animations. If you want the static image to show any other frame of the animation, rewrite the MuPAD code so that it creates a static plot showing that image. If you want to recreate the animation, rewrite the code in MATLAB by using <code>f Animator</code> and <code>playAnimation</code>.</p>
<p>Potentially incorrect MuPAD code "{0}". Replacing it by "{1}".</p>	<p>When translating a notebook file, <code>convertMuPADNotebook</code> detected that the part of the code in the MuPAD notebook might be incorrect. For example, the code appears to have a typo, or a commonly used argument is missing.</p> <p><code>convertMuPADNotebook</code> corrected it.</p>	<p>Verify the corrected code. Then delete this warning.</p>

Warning Message	Meaning	Recommendations
Invalid assignment to remember table. Replacing it by procedure definition.	When translating a notebook file, <code>convertMuPADNotebook</code> considered an assignment to a remember table in a MuPAD notebook as unintentional, and replaced it by a procedure definition. For example, an assignment such as <code>f(x):=x^2</code> gets replaced by <code>f:= x->x^2</code> .	Verify the corrected code. Then delete this warning.
Replacing MuPAD domain by an anonymous function that creates objects similar to the elements of this domain.	Domains represent data types in MuPAD. They are not available in MATLAB. <code>convertMuPADNotebook</code> translated a MuPAD domain to a MATLAB anonymous function that creates objects similar to the elements of the domain. For example, the code line <code>f:=Dom::IntegerMod(7)</code> gets translated to a MATLAB anonymous function <code>f = @(X)mod(X, sym(7))</code> .	Verify the resulting code. Check if an anonymous MATLAB function is the correct translation of the domain in this case, and that the code still has the desired functionality.
Ignoring <code>addpattern</code> command. Configurable pattern matcher not available in MATLAB.	<code>addpattern</code> functionality is not available in MATLAB.	Adjust the code to avoid using <code>addpattern</code> .
Ignoring assertions.	Assertions are not available in MATLAB. When translating a notebook file, <code>convertMuPADNotebook</code> ignores assertions.	Verify the resulting code. If assertions are not essential part of your code, you can ignore this warning. However, if your code relies on assertions, you can implement them using conditional statements, such as <code>if-then</code> .
Ignoring assignment to a MuPAD environment variable.	Environment variables are global variables, such as <code>HISTORY</code> , <code>LEVEL</code> , <code>ORDER</code> , and so on, that affect the behavior of MuPAD algorithms.	Verify the resulting code. If an assignment to an environment variable is not essential for your code, simply delete the warning. In some cases, you can use name-value pair arguments in each function call, such as setting the value <code>Order</code> in the <code>taylor</code> function call. In other cases, there is no appropriate replacement. Adjust the code so that it does not require a global setting.

Warning Message	Meaning	Recommendations
Ignoring assignment to a protected MuPAD constant or function.	The names of the built-in MuPAD functions, options, and constants are protected. If you try to assign a value to a MuPAD function, option, or constant, the system throws an error. This approach ensures that you will not overwrite a built-in functionality accidentally.	Verify the resulting code. Check if the ignored assignment is essential for the correctness of the code and results. If it is, adjust the code so that it does not use this assignment, but still has the desired functionality. If it is not essential, simply delete this warning.
Ignoring option "hold".	hold is not available in MATLAB.	Adjust the code to avoid using hold.
Ignoring info command. Information not available in MATLAB.	MATLAB functions do not have associated information.	For information on a function, refer to MATLAB documentation.
Ignoring options "{0}".	These options are available in MuPAD, but are not available in MATLAB. Because they do not appear to be essential for this code, convertMuPADNotebook ignores them.	Verify the resulting code. Check if the ignored options are essential for the correctness of the code and results. If they are, adjust the code so that it does not use these options, but still has the desired functionality. If they are not essential, simply delete this warning.
Ignoring MuPAD path variables.	<p>The MuPAD environment variables FILEPATH, NOTEBOOKPATH, WRITEPATH, and READPATH let you specify the working folders for writing new files, searching for files, loading files, and so on if you do not specify the full path to the file.</p> <p>These environment variables are not available in MATLAB.</p>	Verify the resulting code. Check if the ignored path variables are essential for the correctness of the code and results. If they are, adjust the code so that it does not use these preferences, but still has the desired functionality. If they are not essential, simply delete this warning.

Warning Message	Meaning	Recommendations
<p>Ignoring MuPAD preference because there is no equivalent setting in MATLAB.</p>	<p>The MuPAD Pref library provides a collection of functions which can be used to set and restore preferences, such as use of abbreviations in outputs, representation of floating-point numbers, memory limit on a MuPAD session, and so on.</p> <p>MATLAB uses <code>sympref</code> for a few preferences, such as specifying parameters of Fourier transforms, specifying the value of the Heaviside function at 0, or enabling and disabling abbreviations in outputs. Most preferences cannot be translated to MATLAB code.</p>	<p>Verify the resulting code. Check if the ignored preferences are essential for the correctness of the code and results. If they are not essential, simply delete this warning.</p>
<p>Ignoring call to variable protection mechanism.</p>	<p>The names of the built-in MuPAD functions, options, and constants are protected. If you try to assign a value to a MuPAD function, option, or constant, the system throws an error. This approach ensures that you will not overwrite a built-in functionality accidentally.</p> <p>Protecting procedures and functions from overwriting is not available in MATLAB. When translating a notebook file, <code>convertMuPADNotebook</code> ignores the corresponding MuPAD code.</p>	<p>Verify the resulting code. Check if the ignored call to variable protection mechanism is essential for the correctness of the code and results. If it is, adjust the code so that it does not use this call, but still has the desired functionality. If it is not essential, simply delete this warning.</p>

Warning Message	Meaning	Recommendations
Ignoring default value when translating a table.	<p>MuPAD tables let you set the default value. This value is returned when you index into a table using the index for which the entry does not exist. For example, if you create the table using <code>T := table(a = 13, c = 42, 10)</code>, and then index into it using <code>T[b]</code>, the result is 10.</p> <p>Default values for tables cannot be translated to MATLAB. When translating a notebook file, <code>convertMuPADNotebook</code> ignores the corresponding value.</p>	Verify the resulting code. Check if the ignored value is essential for the correctness of the code and results. If default values for the tables are not essential, simply delete this warning. Otherwise, you can create a MATLAB function that checks if the <code>containers.Map</code> object corresponding to the MuPAD table has a certain key, and if it does not, returns the default value.
Unable to decide which object the indexing refers to, instead using generic translation.	When the class of the object being indexed into is ambiguous, then <code>convertMuPADNotebook</code> defaults to a generic translation for the indexing.	Verify that the generic translation returns the correct result. If not, adjust the code.
Possibly missing a multiplication sign.	Do not skip multiplication signs in MuPAD and MATLAB code. Both languages require you to type multiplication signs explicitly. For example, the expression $x(x + 1)$ must be typed as <code>x*(x + 1)</code> .	Verify the converted code. Check if you missed a multiplication sign. Correct the code if needed.
Expression used as operator. Possibly "subs" was intended.	An arithmetical expression is used as a function. <code>convertMuPADNotebook</code> attempted to fix the error.	Verify that the translation returns the correct result. If not, adjust the code.
MuPAD package mechanism not available in MATLAB.	The MuPAD package mechanism is not available in MATLAB.	Adjust the code to avoid using the MuPAD package mechanism.

Differences Between MATLAB and MuPAD Syntax

Note MuPAD notebook has been removed. Use MATLAB Live Editor instead.

To convert a MuPAD notebook file to a MATLAB live script file, see `convertMuPADNotebook`. MATLAB live scripts support most MuPAD functionality, although there are some differences. For more information, see “Convert MuPAD Notebooks to MATLAB Live Scripts” on page 3-3.

There are several differences between MATLAB and MuPAD syntax. Be aware of which interface you are using in order to use the correct syntax:

- Use MATLAB syntax in the MATLAB workspace, *except* for the functions `evalin(symengine, ...)` and `feval(symengine, ...)`, which use MuPAD syntax.
- Use MuPAD syntax only in MuPAD notebooks.

You must define MATLAB variables before using them. However, every expression entered in a MuPAD notebook is assumed to be a combination of symbolic variables unless otherwise defined. This means that you must be especially careful when working in MuPAD notebooks, since fewer of your typos cause syntax errors.

This table lists common tasks, meaning commands or functions, and how they differ in MATLAB and MuPAD syntax.

Common Tasks in MATLAB and MuPAD Syntax

Task	MuPAD Syntax	MATLAB Syntax
Assignment	<code>:=</code>	<code>=</code>
List variables	<code>anames(All, User)</code>	<code>whos</code>
Numerical value of expression	<code>float(expression)</code>	<code>double(expression)</code>
Suppress output	<code>:</code>	<code>;</code>
Enter matrix	<code>matrix([[x11,x12,x13], [x21,x22,x23]])</code>	<code>[x11,x12,x13; x21,x22,x23]</code>
Translate MuPAD set	<code>{a,b,c}</code>	<code>unique([1 2 3])</code>
Auto-completion	Ctrl+space bar	Tab
Equality, inequality comparison	<code>=, <></code>	<code>==, ~=</code>

The next table lists differences between MATLAB expressions and MuPAD expressions.

MATLAB vs. MuPAD Expressions

MuPAD Expression	MATLAB Expression
infinity	Inf
PI	pi
I	i
undefined	NaN
trunc	fix
arcsin, arccos etc.	asin, acos etc.
numeric::int	vpaintegral
normal	simplifyFraction
besselJ, besselY, besselI, besselK	besselj, bessely, besseli, besselk
lambertW	lambertw
Si, Ci	sinint, cosint
EULER	eulergamma
conjugate	conj
CATALAN	catalan
TRUE, FALSE	symtrue, symfalse

The MuPAD definition of exponential integral differs from the Symbolic Math Toolbox counterpart.

	Symbolic Math Toolbox Definition	MuPAD Definition
Exponential integral	<p>Symbolic Math Toolbox provides two functions to calculate exponential integrals: <code>expint(x)</code> and <code>ei(x)</code>. The definitions of these two functions are described below.</p> $\text{expint}(x) = \int_x^{\infty} \frac{e^{-t}}{t} dt.$ $\text{expint}(n, x) = \int_1^{\infty} \frac{e^{-xt}}{t^n} dt.$ $\text{ei}(x) = \int_{-\infty}^x \frac{e^t}{t} dt.$	$\text{Ei}(x) = \int_{-\infty}^x \frac{e^t}{t} dt.$ $\text{Ei}(n, x) = \int_1^{\infty} \frac{e^{-xt}}{t^n} dt.$ <p>The definitions of <code>Ei</code> extend to the complex plane, with a branch cut along the negative real axis.</p>

Call Built-In MuPAD Functions from MATLAB

Note MuPAD notebook has been removed. Use MATLAB Live Editor instead.

To convert a MuPAD notebook file to a MATLAB live script file, see `convertMuPADNotebook`. MATLAB live scripts support most MuPAD functionality, although there are some differences. For more information, see “Convert MuPAD Notebooks to MATLAB Live Scripts” on page 3-3.

To access built-in MuPAD functions at the MATLAB command line, use `evalin(symengine,...)` or `feval(symengine,...)`. These functions are designed to work like the existing MATLAB `evalin` and `feval` functions.

`evalin` and `feval` do not open a MuPAD notebook, and therefore, you cannot use these functions to access MuPAD graphics capabilities.

evalin

For `evalin`, the syntax is

```
y = evalin(symengine, 'MuPAD_Expression');
```

Use `evalin` when you want to perform computations in the MuPAD language, while working in the MATLAB workspace. For example, to make a three-element symbolic vector of the `sin(kx)` function, `k = 1` to `3`, enter:

```
y = evalin(symengine, '[sin(k*x) $ k = 1..3]')
y =
[ sin(x), sin(2*x), sin(3*x)]
```

feval

For evaluating a MuPAD function, you can also use the `feval` function. `feval` has a different syntax than `evalin`, so it can be simpler to use. The syntax is:

```
y = feval(symengine, 'MuPAD_Function', x1, ..., xn);
```

MuPAD_Function represents the name of a MuPAD function. The arguments `x1, ..., xn` must be symbolic variables, numbers, or character vectors. For example, to find the tenth element in the Fibonacci sequence, enter:

```
z = feval(symengine, 'numlib::fibonacci', 10)
z =
55
```

The next example compares the use of a symbolic solution of an equation to the solution returned by the MuPAD numeric `fsolve` function near the point `x = 3`. The symbolic solver returns these results:

```
syms x
f = sin(x^2);
solve(f)
```

```
ans =
0
```

The numeric solver `fsolve` returns this result:

```
feval(symengine, 'numeric::fsolve', f, 'x=3')
```

```
ans =
x == 3.0699801238394654654386548746678
```

As you might expect, the answer is the numerical value of $\sqrt{3\pi}$. The setting of MATLAB format does not affect the display; it is the full returned value from the MuPAD `'numeric::fsolve'` function.

evalin vs. feval

The `evalin(symengine, ...)` function causes the MuPAD engine to evaluate a character vector. Since the MuPAD engine workspace is generally empty, expressions returned by `evalin(symengine, ...)` are not simplified or evaluated according to their definitions in the MATLAB workspace. For example:

```
syms x
y = x^2;
evalin(symengine, 'cos(y)')
```

```
ans =
cos(y)
```

Variable `y` is not expressed in terms of `x` because `y` is unknown to the MuPAD engine.

In contrast, `feval(symengine, ...)` can pass symbolic variables that exist in the MATLAB workspace, and these variables are evaluated before being processed in the MuPAD engine. For example:

```
syms x
y = x^2;
feval(symengine, 'cos', y)
```

```
ans =
cos(x^2)
```

Floating-Point Arguments of evalin and feval

By default, MuPAD performs all computations in an exact form. When you call the `evalin` or `feval` function with floating-point numbers as arguments, the toolbox converts these arguments to rational numbers before passing them to MuPAD. For example, when you calculate the incomplete gamma function, the result is the following symbolic expression:

```
y = feval(symengine, 'igamma', 0.1, 2.5)
```

```
y =
igamma(1/10, 5/2)
```

To approximate the result numerically with double precision, use the `double` function:

```
format long
double(y)
```

```
ans =  
0.028005841168289
```

Alternatively, use quotes to prevent the conversion of floating-point arguments to rational numbers. (The toolbox treats arguments enclosed in quotes as character vectors.) When MuPAD performs arithmetic operations on numbers involving at least one floating-point number, it automatically switches to numeric computations and returns a floating-point result:

```
feval(symengine,'igamma', '0.1', 2.5)
```

```
ans =  
0.028005841168289177028337498391181
```

For further computations, set the format for displaying outputs back to short:

```
format short
```

Functions

abs

Symbolic absolute value (complex modulus or magnitude)

Syntax

```
abs(z)
```

Description

`abs(z)` returns the absolute value (or complex modulus) of z . Because symbolic variables are assumed to be complex by default, `abs` returns the complex modulus (magnitude) by default. If z is an array, `abs` acts element-wise on each element of z .

Examples

Compute Absolute Values of Symbolic Numbers

```
[abs(sym(1/2)), abs(sym(0)), abs(sym(pi) - 4)]
```

```
ans =  
[ 1/2, 0, 4 - pi]
```

Compute Absolute Value of Complex Numbers

Compute `abs(x)^2` and simplify the result. Because symbolic variables are assumed to be complex by default, the result does not simplify to x^2 .

```
syms x  
simplify(abs(x)^2)
```

```
ans =  
abs(x)^2
```

Assume x is real, and repeat the calculation. Now, the result is simplified to x^2 .

```
assume(x, 'real')  
simplify(abs(x)^2)
```

```
ans =  
x^2
```

Remove assumptions on x for further calculations. For details, see “Use Assumptions on Symbolic Variables” on page 1-24.

```
assume(x, 'clear')
```

Absolute Values of Elements of Array

Compute the absolute values of each element of matrix A.

```
A = sym([1/2+i -25;
        i      pi/2]);
abs(A)

ans =
[ 5^(1/2)/2, 25]
[          1, pi/2]
```

Effect of Assumptions on Absolute Value

Compute the absolute value of this expression assuming that the value of x is negative.

```
syms x
assume(x < 0)
abs(5*x^3)

ans =
-5*x^3
```

For further computations, clear the assumption on x by recreating it using `syms`:

```
syms x
```

Input Arguments

z — Input

number | vector | matrix | multidimensional array | symbolic number | symbolic array | symbolic function | symbolic expression

Input, specified as a number, vector, matrix, or array, or a symbolic number, vector, matrix, or array, variable, function, or expression.

More About

Complex Modulus

The absolute value of a complex number $z = x + y*i$ is the value $|z| = \sqrt{x^2 + y^2}$. Here, x and y are real numbers. The absolute value of a complex number is also called a complex modulus.

Tips

- Calling `abs` for a number that is not a symbolic object invokes the MATLAB `abs` function.

See Also

`angle` | `imag` | `real` | `sign` | `signIm`

Introduced before R2006a

acos

Symbolic inverse cosine function

Syntax

`acos(X)`

Description

`acos(X)` returns the inverse cosine function (arccosine function) of X . All angles are in radians.

- For real values of X in the interval $[-1, 1]$, `acos(x)` returns the values in the interval $[0, \pi]$.
- For real values of X outside the interval $[-1, 1]$ and for complex values of X , `acos(X)` returns complex values with the real parts in the interval $[0, \pi]$.

Examples

Inverse Cosine Function for Numeric and Symbolic Arguments

Depending on its arguments, `acos` returns floating-point or exact symbolic results.

Compute the inverse cosine function for these numbers. Because these numbers are not symbolic objects, `acos` returns floating-point results.

```
A = acos([-1, -1/3, -1/2, 1/4, 1/2, sqrt(3)/2, 1])
```

```
A =
    3.1416    1.9106    2.0944    1.3181    1.0472    0.5236    0
```

Compute the inverse cosine function for the numbers converted to symbolic objects. For many symbolic (exact) numbers, `acos` returns unresolved symbolic calls.

```
symA = acos(sym([-1, -1/3, -1/2, 1/4, 1/2, sqrt(3)/2, 1]))
```

```
symA =
[ pi, pi - acos(1/3), (2*pi)/3, acos(1/4), pi/3, pi/6, 0]
```

Use `vpa` to approximate symbolic results with floating-point numbers:

```
vpa(symA)
```

```
ans =
[ 3.1415926535897932384626433832795, ...
 1.9106332362490185563277142050315, ...
 2.0943951023931954923084289221863, ...
 1.318116071652817965745664254646, ...
 1.0471975511965977461542144610932, ...
 0.52359877559829887307710723054658, ...
 0]
```

Plot Inverse Cosine Function

Plot the inverse cosine function on the interval from -1 to 1.

```
syms x
fplot(acos(x), [-1 1])
grid on
```

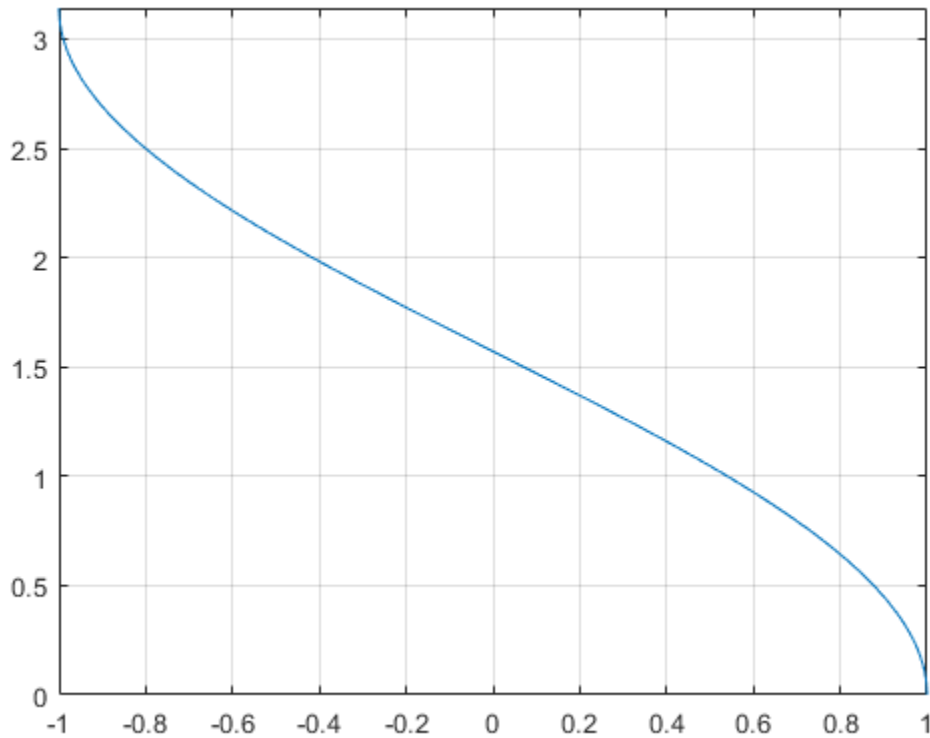

Handle Expressions Containing Inverse Cosine Function

Many functions, such as `diff`, `int`, `taylor`, and `rewrite`, can handle expressions containing `acos`.

Find the first and second derivatives of the inverse cosine function:

```
syms x
diff(acos(x), x)
diff(acos(x), x, x)
```

```
ans =
-1/(1 - x^2)^(1/2)
```

```
ans =
-x/(1 - x^2)^(3/2)
```

Find the indefinite integral of the inverse cosine function:

```
int(acos(x), x)
```

```
ans =
x*acos(x) - (1 - x^2)^(1/2)
```

Find the Taylor series expansion of `acos(x)`:

```
taylor(acos(x), x)
```

```
ans =  
- (3*x^5)/40 - x^3/6 - x + pi/2
```

Rewrite the inverse cosine function in terms of the natural logarithm:

```
rewrite(acos(x), 'log')
```

```
ans =  
-log(x + (1 - x^2)^(1/2)*1i)*1i
```

Input Arguments

X – Input

symbolic number | symbolic variable | symbolic expression | symbolic function | symbolic vector | symbolic matrix

Input, specified as a symbolic number, variable, expression, or function, or as a vector or matrix of symbolic numbers, variables, expressions, or functions.

See Also

acot | acsc | asec | asin | atan | cos | cot | csc | sec | sin | tan

Introduced before R2006a

acosh

Symbolic inverse hyperbolic cosine function

Syntax

`acosh(X)`

Description

`acosh(X)` returns the inverse hyperbolic cosine function of X .

Examples

Inverse Hyperbolic Cosine Function for Numeric and Symbolic Arguments

Depending on its arguments, `acosh` returns floating-point or exact symbolic results.

Compute the inverse hyperbolic cosine function for these numbers. Because these numbers are not symbolic objects, `acosh` returns floating-point results.

```
A = acosh([-1, 0, 1/6, 1/2, 1, 2])
```

```
A =
    0.0000 + 3.1416i    0.0000 + 1.5708i    0.0000 + 1.4033i...
    0.0000 + 1.0472i    0.0000 + 0.0000i    1.3170 + 0.0000i
```

Compute the inverse hyperbolic cosine function for the numbers converted to symbolic objects. For many symbolic (exact) numbers, `acosh` returns unresolved symbolic calls.

```
symA = acosh(sym([-1, 0, 1/6, 1/2, 1, 2]))
```

```
symA =
[ pi*i, (pi*i)/2, acosh(1/6), (pi*i)/3, 0, acosh(2) ]
```

Use `vpa` to approximate symbolic results with floating-point numbers:

```
vpa(symA)
```

```
ans =
[ 3.1415926535897932384626433832795i,...
  1.5707963267948966192313216916398i,...
  1.4033482475752072886780470855961i,...
  1.0471975511965977461542144610932i,...
  0,...
  1.316957896924816708625046347308]
```

Plot Inverse Hyperbolic Cosine Function

Plot the inverse hyperbolic cosine function on the interval from 1 to 10.

```
syms x
fplot(acosh(x), [1 10])
grid on
```

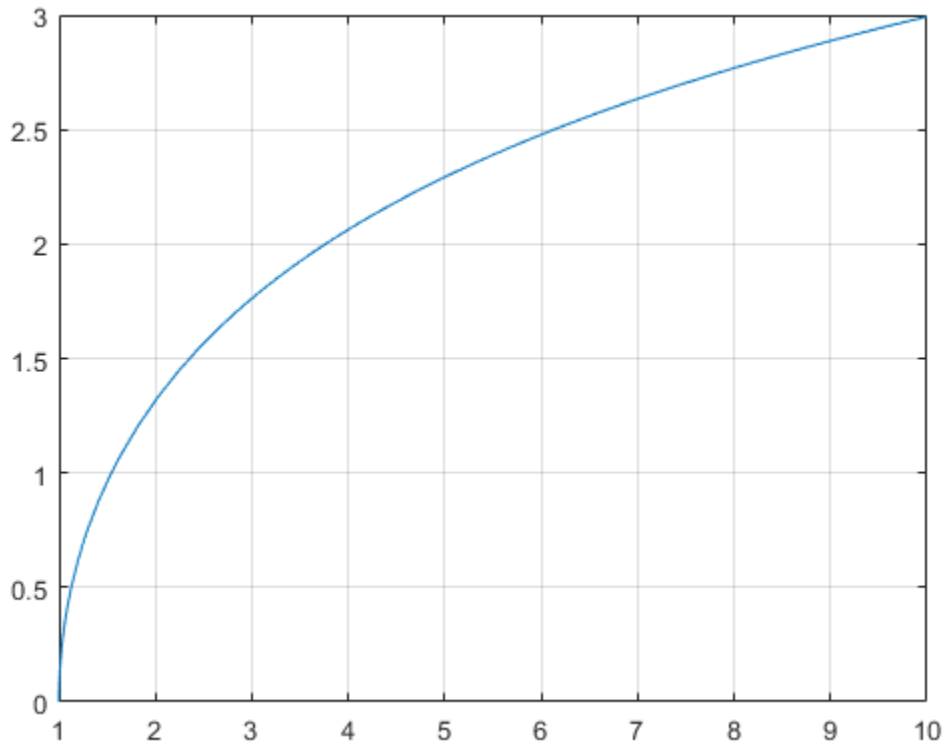

Handle Expressions Containing Inverse Hyperbolic Cosine Function

Many functions, such as `diff`, `int`, `taylor`, and `rewrite`, can handle expressions containing `acosh`.

Find the first and second derivatives of the inverse hyperbolic cosine function. Simplify the second derivative by using `simplify`.

```
syms x
diff(acosh(x), x)
simplify(diff(acosh(x), x, x))
```

```
ans =
1/((x - 1)^(1/2)*(x + 1)^(1/2))
```

```
ans =
-x/((x - 1)^(3/2)*(x + 1)^(3/2))
```

Find the indefinite integral of the inverse hyperbolic cosine function. Simplify the result by using `simplify`.

```
int(acosh(x), x)
```

```
ans =  
x*acosh(x) - (x - 1)^(1/2)*(x + 1)^(1/2)
```

Find the Taylor series expansion of `acosh(x)` for $x > 1$:

```
assume(x > 1)  
taylor(acosh(x), x)
```

```
ans =  
(x^5*3i)/40 + (x^3*1i)/6 + x*1i - (pi*1i)/2
```

For further computations, clear the assumption on `x` by recreating it using `syms`:

```
syms x
```

Rewrite the inverse hyperbolic cosine function in terms of the natural logarithm:

```
rewrite(acosh(x), 'log')
```

```
ans =  
log(x + (x - 1)^(1/2)*(x + 1)^(1/2))
```

Input Arguments

X — Input

symbolic number | symbolic variable | symbolic expression | symbolic function | symbolic vector | symbolic matrix

Input, specified as a symbolic number, variable, expression, or function, or as a vector or matrix of symbolic numbers, variables, expressions, or functions.

See Also

`acoth` | `acsch` | `asech` | `asinh` | `atanh` | `cosh` | `coth` | `csch` | `sech` | `sinh` | `tanh`

Introduced before R2006a

acot

Symbolic inverse cotangent function

Syntax

`acot(X)`

Description

`acot(X)` returns the inverse cotangent function (arccotangent function) of X . All angles are in radians.

- For real values of X , `acot(X)` returns values in the interval $[-\pi/2, \pi/2]$.
- For complex values of X , `acot(X)` returns complex values with the real parts in the interval $[-\pi/2, \pi/2]$.

Examples

Inverse Cotangent Function for Numeric and Symbolic Arguments

Depending on its arguments, `acot` returns floating-point or exact symbolic results.

Compute the inverse cotangent function for these numbers. Because these numbers are not symbolic objects, `acot` returns floating-point results.

```
A = acot([-1, -1/3, -1/sqrt(3), 1/2, 1, sqrt(3)])
A =
    -0.7854    -1.2490    -1.0472     1.1071     0.7854     0.5236
```

Compute the inverse cotangent function for the numbers converted to symbolic objects. For many symbolic (exact) numbers, `acot` returns unresolved symbolic calls.

```
symA = acot(sym([-1, -1/3, -1/sqrt(3), 1/2, 1, sqrt(3)]))
symA =
[ -pi/4, -acot(1/3), -pi/3, acot(1/2), pi/4, pi/6]
```

Use `vpa` to approximate symbolic results with floating-point numbers:

```
vpa(symA)
ans =
[ -0.78539816339744830961566084581988, ...
 -1.2490457723982544258299170772811, ...
 -1.0471975511965977461542144610932, ...
 1.1071487177940905030170654601785, ...
 0.78539816339744830961566084581988, ...
 0.52359877559829887307710723054658]
```

Plot Inverse Cotangent Function

Plot the inverse cotangent function on the interval from -10 to 10.

```
syms x
fplot(acot(x), [-10 10])
grid on
```

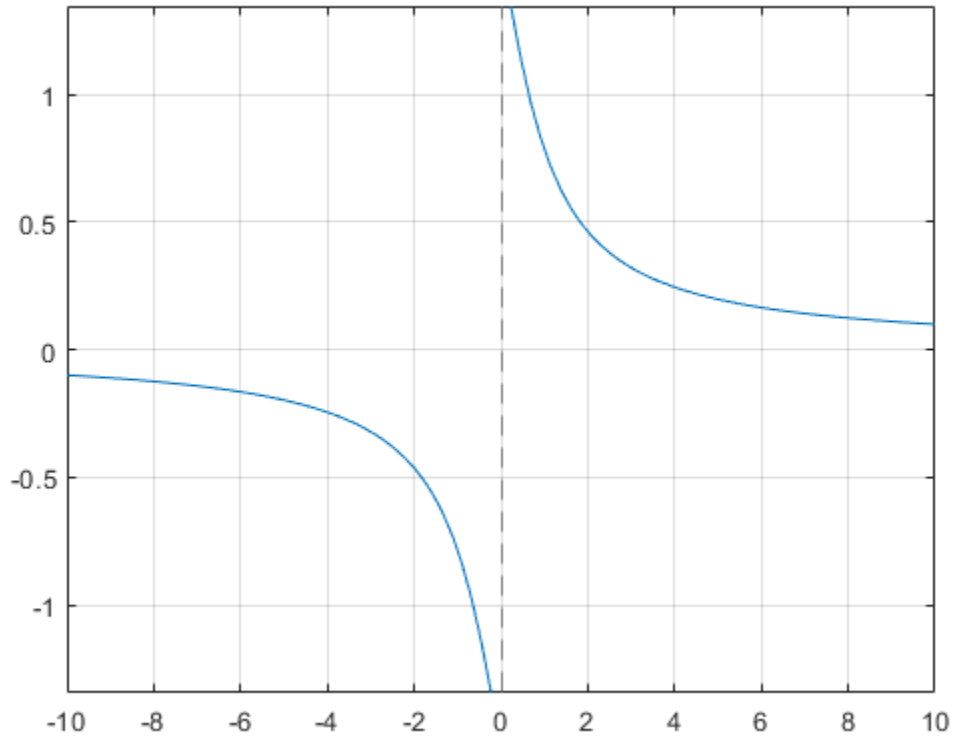

Handle Expressions Containing Inverse Cotangent Function

Many functions, such as `diff`, `int`, `taylor`, and `rewrite`, can handle expressions containing `acot`.

Find the first and second derivatives of the inverse cotangent function:

```
syms x
diff(acot(x), x)
diff(acot(x), x, x)
```

```
ans =
-1/(x^2 + 1)
```

```
ans =
(2*x)/(x^2 + 1)^2
```

Find the indefinite integral of the inverse cotangent function:

```
int(acot(x), x)
```

```
ans =
log(x^2 + 1)/2 + x*acot(x)
```

Find the Taylor series expansion of `acot(x)` for $x > 0$:

```
assume(x > 0)
taylor(acot(x), x)
```

```
ans =
- x^5/5 + x^3/3 - x + pi/2
```

For further computations, clear the assumption on x by recreating it using `syms`:

```
syms x
```

Rewrite the inverse cotangent function in terms of the natural logarithm:

```
rewrite(acot(x), 'log')
```

```
ans =
(log(1 - 1i/x)*1i)/2 - (log(1i/x + 1)*1i)/2
```

Input Arguments

X — Input

symbolic number | symbolic variable | symbolic expression | symbolic function | symbolic vector | symbolic matrix

Input, specified as a symbolic number, variable, expression, or function, or as a vector or matrix of symbolic numbers, variables, expressions, or functions.

See Also

`acos` | `acsc` | `asec` | `asin` | `atan` | `cos` | `cot` | `csc` | `sec` | `sin` | `tan`

Introduced before R2006a

acoth

Symbolic inverse hyperbolic cotangent function

Syntax

`acoth(X)`

Description

`acoth(X)` returns the inverse hyperbolic cotangent function of X .

Examples

Inverse Hyperbolic Cotangent Function for Numeric and Symbolic Arguments

Depending on its arguments, `acoth` returns floating-point or exact symbolic results.

Compute the inverse hyperbolic cotangent function for these numbers. Because these numbers are not symbolic objects, `acoth` returns floating-point results.

```
A = acoth([-pi/2, -1, 0, 1/2, 1, pi/2])
```

```
A =
-0.7525 + 0.0000i    -Inf + 0.0000i    0.0000 + 1.5708i...
 0.5493 + 1.5708i    Inf + 0.0000i    0.7525 + 0.0000i
```

Compute the inverse hyperbolic cotangent function for the numbers converted to symbolic objects. For many symbolic (exact) numbers, `acoth` returns unresolved symbolic calls.

```
symA = acoth(sym([-pi/2, -1, 0, 1/2, 1, pi/2]))
```

```
symA =
[ -acoth(pi/2), Inf, -(pi*1i)/2, acoth(1/2), Inf, acoth(pi/2)]
```

Use `vpa` to approximate symbolic results with floating-point numbers:

```
vpa(symA)
```

```
ans =
[ -0.75246926714192715916204347800251,...
  Inf,...
 -1.5707963267948966192313216916398i,...
 0.54930614433405484569762261846126...
 - 1.5707963267948966192313216916398i,...
  Inf,...
 0.75246926714192715916204347800251]
```

Plot Inverse Hyperbolic Cotangent Function

Plot the inverse hyperbolic cotangent function on the interval from -10 to 10.

```
syms x
fplot(acoth(x),[-10 10])
grid on
```

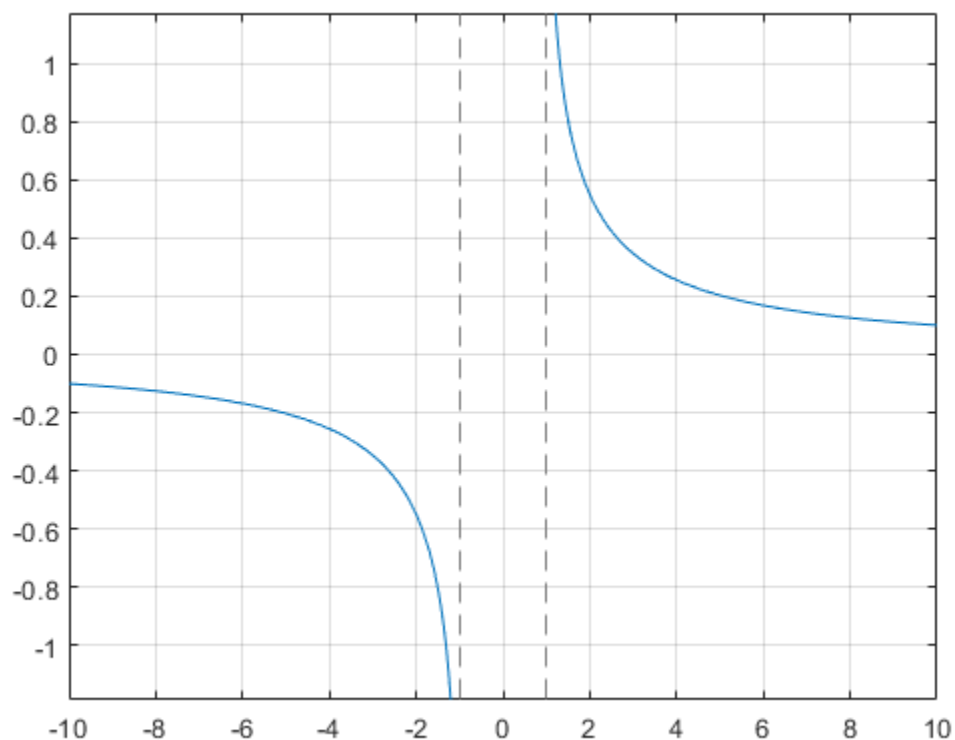

Handle Expressions Containing Inverse Hyperbolic Cotangent Function

Many functions, such as `diff`, `int`, `taylor`, and `rewrite`, can handle expressions containing `acoth`.

Find the first and second derivatives of the inverse hyperbolic cotangent function:

```
syms x
diff(acoth(x), x)
diff(acoth(x), x, x)
```

```
ans =
-1/(x^2 - 1)
```

```
ans =
(2*x)/(x^2 - 1)^2
```

Find the indefinite integral of the inverse hyperbolic cotangent function:

```
int(acoth(x), x)
```

```
ans =
log(x^2 - 1)/2 + x*acoth(x)
```

Find the Taylor series expansion of $\operatorname{acoth}(x)$ for $x > 0$:

```
assume(x > 0)
taylor(acoth(x), x)

ans =
x^5/5 + x^3/3 + x - (pi*Ii)/2
```

For further computations, clear the assumption on x by recreating it using `syms`:

```
syms x
```

Rewrite the inverse hyperbolic cotangent function in terms of the natural logarithm:

```
rewrite(acoth(x), 'log')

ans =
log(1/x + 1)/2 - log(1 - 1/x)/2
```

Input Arguments

X — Input

symbolic number | symbolic variable | symbolic expression | symbolic function | symbolic vector | symbolic matrix

Input, specified as a symbolic number, variable, expression, or function, or as a vector or matrix of symbolic numbers, variables, expressions, or functions.

See Also

`acosh` | `acsch` | `asech` | `asinh` | `atanh` | `cosh` | `coth` | `csch` | `sech` | `sinh` | `tanh`

Introduced before R2006a

acsc

Symbolic inverse cosecant function

Syntax

`acsc(X)`

Description

`acsc(X)` returns the inverse cosecant function (arccosecant function) of X . All angles are in radians.

- For real values of X in intervals $[-\text{Inf}, -1]$ and $[1, \text{Inf}]$, `acsc` returns real values in the interval $[-\pi/2, \pi/2]$.
- For real values of X in the interval $[-1, 1]$ and for complex values of X , `acsc` returns complex values with the real parts in the interval $[-\pi/2, \pi/2]$.

Examples

Inverse Cosecant Function for Numeric and Symbolic Arguments

Depending on its arguments, `acsc` returns floating-point or exact symbolic results.

Compute the inverse cosecant function for these numbers. Because these numbers are not symbolic objects, `acsc` returns floating-point results.

```
A = acsc([-2, 0, 2/sqrt(3), 1/2, 1, 5])
```

```
A =
-0.5236 + 0.0000i   1.5708 -   Inf   1.0472 + 0.0000i   1.5708...
- 1.3170i   1.5708 + 0.0000i   0.2014 + 0.0000i
```

Compute the inverse cosecant function for the numbers converted to symbolic objects. For many symbolic (exact) numbers, `acsc` returns unresolved symbolic calls.

```
symA = acsc(sym([-2, 0, 2/sqrt(3), 1/2, 1, 5]))
```

```
symA =
[ -pi/6, Inf, pi/3, asin(2), pi/2, asin(1/5)]
```

Use `vpa` to approximate symbolic results with floating-point numbers:

```
vpa(symA)
```

```
ans =
[ -0.52359877559829887307710723054658,...
  Inf,...
  1.0471975511965977461542144610932,...
  1.5707963267948966192313216916398...
  - 1.3169578969248165734029498707969i,...
  1.5707963267948966192313216916398,...
  0.20135792079033079660099758712022]
```

Plot Inverse Cosecant Function

Plot the inverse cosecant function on the interval from -10 to 10.

```
syms x
fplot(acsc(x), [-10 10])
grid on
```

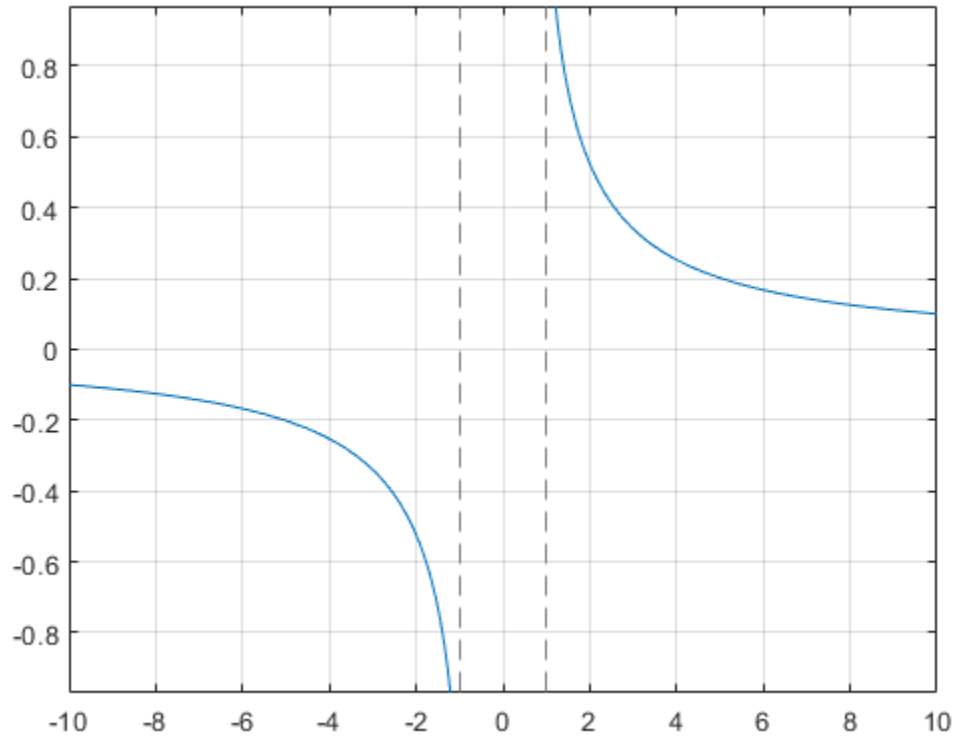

Handle Expressions Containing Inverse Cosecant Function

Many functions, such as `diff`, `int`, `taylor`, and `rewrite`, can handle expressions containing `acsc`.

Find the first and second derivatives of the inverse cosecant function:

```
syms x
diff(acsc(x), x)
diff(acsc(x), x, x)
```

```
ans =
-1/(x^2*(1 - 1/x^2)^(1/2))
```

```
ans =
2/(x^3*(1 - 1/x^2)^(1/2)) + 1/(x^5*(1 - 1/x^2)^(3/2))
```

Find the indefinite integral of the inverse cosecant function:

```
int(acsc(x), x)
```



```
ans =
x*asin(1/x) + log(x + (x^2 - 1)^(1/2))*sign(x)
```

Find the Taylor series expansion of `acsc(x)` around `x = Inf`:

```
taylor(acsc(x), x, Inf)
```

```
ans =
1/x + 1/(6*x^3) + 3/(40*x^5)
```

Rewrite the inverse cosecant function in terms of the natural logarithm:

```
rewrite(acsc(x), 'log')
```

```
ans =
-log(1i/x + (1 - 1/x^2)^(1/2))*1i
```

Input Arguments

X — Input

symbolic number | symbolic variable | symbolic expression | symbolic function | symbolic vector | symbolic matrix

Input, specified as a symbolic number, variable, expression, or function, or as a vector or matrix of symbolic numbers, variables, expressions, or functions.

See Also

`acos` | `acot` | `asec` | `asin` | `atan` | `cos` | `cot` | `csc` | `sec` | `sin` | `tan`

Introduced before R2006a

acsch

Symbolic inverse hyperbolic cosecant function

Syntax

`acsch(X)`

Description

`acsch(X)` returns the inverse hyperbolic cosecant function of X .

Examples

Inverse Hyperbolic Cosecant Function for Numeric and Symbolic Arguments

Depending on its arguments, `acsch` returns floating-point or exact symbolic results.

Compute the inverse hyperbolic cosecant function for these numbers. Because these numbers are not symbolic objects, `acsch` returns floating-point results.

```
A = acsch([-2*i, 0, 2*i/sqrt(3), 1/2, i, 3])
```

```
A =
    0.0000 + 0.5236i      Inf + 0.0000i    0.0000 - 1.0472i...
    1.4436 + 0.0000i    0.0000 - 1.5708i    0.3275 + 0.0000i
```

Compute the inverse hyperbolic cosecant function for the numbers converted to symbolic objects. For many symbolic (exact) numbers, `acsch` returns unresolved symbolic calls.

```
symA = acsch(sym([-2*i, 0, 2*i/sqrt(3), 1/2, i, 3]))
```

```
symA =
[ (pi*1i)/6, Inf, -(pi*1i)/3, asinh(2), -(pi*1i)/2, asinh(1/3)]
```

Use `vpa` to approximate symbolic results with floating-point numbers:

```
vpa(symA)
```

```
ans =
[ 0.52359877559829887307710723054658i,...
  Inf,...
 -1.0471975511965977461542144610932i,...
 1.4436354751788103424932767402731,...
 -1.5707963267948966192313216916398i,...
 0.32745015023725844332253525998826]
```

Plot Inverse Hyperbolic Cosecant Function

Plot the inverse hyperbolic cosecant function on the interval from -10 to 10.

```
syms x
fplot(acsch(x),[-10 10])
grid on
```

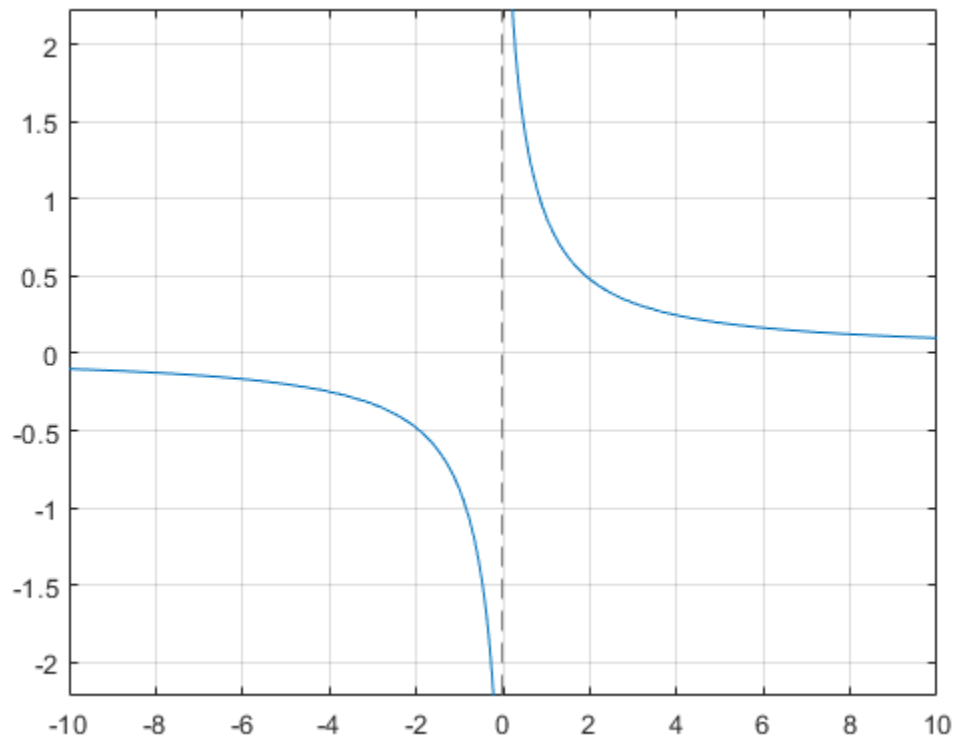

Handle Expressions Containing Inverse Hyperbolic Cosecant Function

Many functions, such as `diff`, `int`, `taylor`, and `rewrite`, can handle expressions containing `acsch`.

Find the first and second derivatives of the inverse hyperbolic cosecant function:

```
syms x
diff(acsch(x), x)
diff(acsch(x), x, x)
```

```
ans =
-1/(x^2*(1/x^2 + 1)^(1/2))
```

```
ans =
2/(x^3*(1/x^2 + 1)^(1/2)) - 1/(x^5*(1/x^2 + 1)^(3/2))
```

Find the indefinite integral of the inverse hyperbolic cosecant function:

```
int(acsch(x), x)
```

```
ans =
x*asinh(1/x) + asinh(x)*sign(x)
```

Find the Taylor series expansion of `acsch(x)` around `x = Inf`:

```
taylor(acsch(x), x, Inf)
```

```
ans =  
1/x - 1/(6*x^3) + 3/(40*x^5)
```

Rewrite the inverse hyperbolic cosecant function in terms of the natural logarithm:

```
rewrite(acsch(x), 'log')
```

```
ans =  
log((1/x^2 + 1)^(1/2) + 1/x)
```

Input Arguments

X — Input

symbolic number | symbolic variable | symbolic expression | symbolic function | symbolic vector | symbolic matrix

Input, specified as a symbolic number, variable, expression, or function, or as a vector or matrix of symbolic numbers, variables, expressions, or functions.

See Also

acosh | acoth | asech | asinh | atanh | cosh | coth | csch | sech | sinh | tanh

Introduced before R2006a

adjoint

Classical adjoint (adjugate) of square matrix

Syntax

```
X = adjoint(A)
```

Description

`X = adjoint(A)` returns the “Classical Adjoint (Adjugate) Matrix” on page 4-24 X of A, such that $A*X = \det(A)*\text{eye}(n) = X*A$, where n is the number of rows in A.

Examples

Classical Adjoint (Adjugate) of Matrix

Find the classical adjoint of a numeric matrix.

```
A = magic(3);
X = adjoint(A)
```

```
X =
   -53.0000    52.0000   -23.0000
    22.0000    -8.0000   -38.0000
     7.0000   -68.0000    37.0000
```

Find the classical adjoint of a symbolic matrix.

```
syms x y z
A = sym([x y z; 2 1 0; 1 0 2]);
X = adjoint(A)
```

```
X =
 [ 2,      -2*y,      -z]
 [ -4, 2*x - z,      2*z]
 [ -1,       y, x - 2*y]
```

Verify that $\det(A)*\text{eye}(3) = X*A$ by using `isAlways`.

```
cond = det(A)*eye(3) == X*A;
isAlways(cond)
```

```
ans =
 3x3 logical array
 1 1 1
 1 1 1
 1 1 1
```

Compute Inverse Using Classical Adjoint and Determinant

Compute the inverse of this matrix by computing its classical adjoint and determinant.

```
syms a b c d
A = [a b; c d];
invA = adjoint(A)/det(A)

invA =
[ d/(a*d - b*c), -b/(a*d - b*c)]
[ -c/(a*d - b*c),  a/(a*d - b*c)]
```

Verify that `invA` is the inverse of `A`.

```
isAlways(invA == inv(A))
```

```
ans =
 2x2 logical array
 1 1
 1 1
```

Input Arguments

A — Square matrix

numeric matrix | symbolic matrix

Square matrix, specified as a numeric or symbolic matrix.

More About

Classical Adjoint (Adjugate) Matrix

The classical adjoint, or adjugate, of a square matrix A is the square matrix X , such that the (i,j) -th entry of X is the (j,i) -th cofactor of A .

The (j,i) -th cofactor of A is defined as follows.

$$a_{ji}' = (-1)^{i+j} \det(A_{ij})$$

A_{ij} is the submatrix of A obtained from A by removing the i -th row and j -th column.

The classical adjoint matrix should not be confused with the adjoint matrix. The adjoint is the conjugate transpose of a matrix while the classical adjoint is another name for the adjugate matrix or cofactor transpose of a matrix.

See Also

`ctranspose` | `det` | `inv` | `rank`

Introduced in R2013a

airy

Airy function

Syntax

```
airy(x)
airy(0,x)
airy(1,x)
airy(2,x)
airy(3,x)
```

```
airy(n,x)
```

```
airy( __ ,1)
```

Description

`airy(x)` returns the Airy function on page 4-30 of the first kind, $Ai(x)$, for each element of x .

`airy(0,x)` is the same as `airy(x)`.

`airy(1,x)` returns the derivative of $Ai(x)$.

`airy(2,x)` returns the Airy function on page 4-30 of the second kind, $Bi(x)$.

`airy(3,x)` returns the derivative of $Bi(x)$.

`airy(n,x)` uses the values in vector n to return the corresponding Airy functions of elements of vector x . Both n and x must have the same size.

`airy(__ ,1)` returns the “Scaled Airy Functions” on page 4-30 following the syntax for the MATLAB `airy` function.

Examples

Find the Airy Function of the First Kind

Find the Airy function of the first kind, $Ai(x)$, for numeric or symbolic inputs using `airy`. Approximate exact symbolic outputs using `vpa`.

Find the Airy function of the first kind, $Ai(x)$, at 1.5. Because the input is double and not symbolic, you get a double result.

```
airy(1.5)
```

```
ans =
    0.0717
```

Find the Airy function of the values of vector v symbolically, by converting v to symbolic form using `sym`. Because the input is symbolic, `airy` returns exact symbolic results. The exact symbolic results for most symbolic inputs are unresolved function calls.

```
v = sym([-1 0 25.1 1+1i]);
vAiry = airy(v)

vAiry =
[ airy(0, -1), 3^(1/3)/(3*gamma(2/3)), airy(0, 251/10), airy(0, 1 + 1i)]
```

Numerically approximate the exact symbolic result using `vpa`.

```
vpa(vAiry)

ans =
[ 0.53556088329235211879951656563887, 0.35502805388781723926006318600418, ...
 4.9152763177499054787371976959487e-38, ...
 0.060458308371838149196532978116646 - 0.15188956587718140235494791259223i]
```

Find the Airy function, $Ai(x)$, of the symbolic input x^2 . For symbolic expressions, `airy` returns an unresolved call.

```
syms x
airy(x^2)

ans =
airy(0, x^2)
```

Find the Airy Function of the Second Kind

Find the Airy function of the second kind, $Bi(x)$, of the symbolic input $[-3 \ 4 \ 1+1i \ x^2]$ by specifying the first argument as 2. Because the input is symbolic, `airy` returns exact symbolic results. The exact symbolic results for most symbolic inputs are unresolved function calls.

```
v = sym([-3 4 1+1i x^2]);
vAiry = airy(2, v)

vAiry =
[ airy(2, -3), airy(2, 4), airy(2, 1 + 1i), airy(2, x^2)]
```

Use the syntax `airy(2,x)` like `airy(x)`, as described in the example “Find the Airy Function of the First Kind” on page 4-25.

Plot Airy Functions

Plot the Airy Functions, $Ai(x)$ and $Bi(x)$, over the interval $[-10 \ 2]$ using `fplot`.

```
syms x
fplot(airy(x), [-10 2])
hold on
fplot(airy(2,x), [-10 2])
legend('Ai(x)', 'Bi(x)', 'Location', 'Best')
title('Airy functions Ai(x) and Bi(x)')
grid on
```

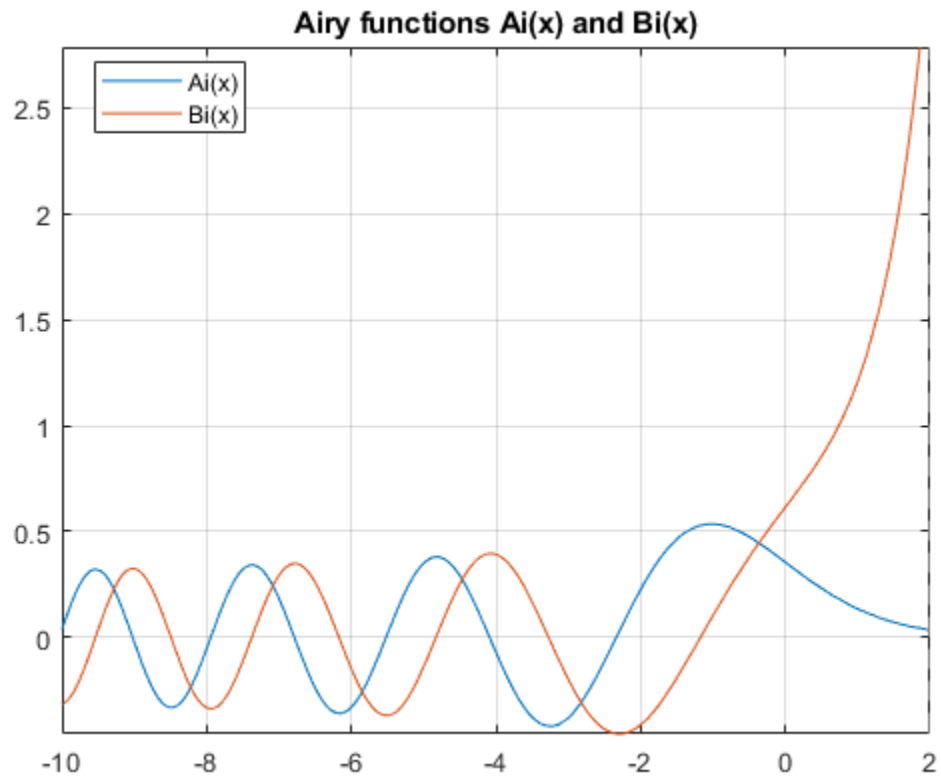
Plot the absolute value of $Ai(z)$ over the complex plane.

```
syms y
z = x + 1i*y;
figure(2)
fsurf(abs(airy(z)))
title('|Ai(z)|')
a = gca;
a.ZLim = [0 10];
caxis([0 10])
```

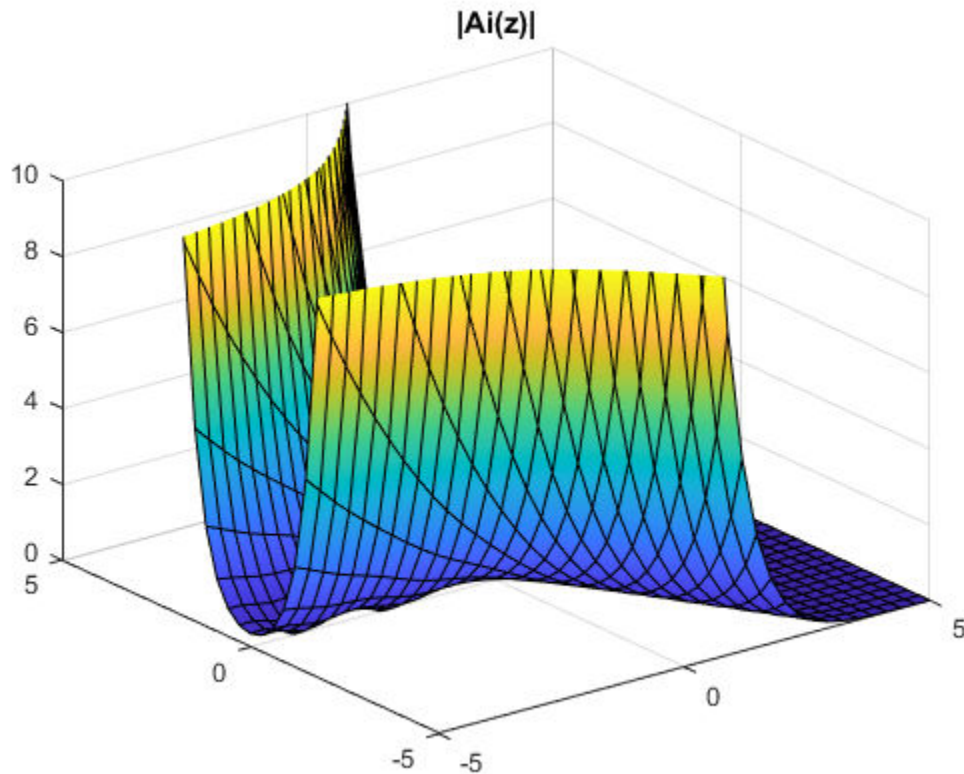

Find Derivatives of Airy Functions

Find the derivative of the Airy function of the first kind, $Ai'(x)$, at 0 by specifying the first argument of `airy` as 1. Then, numerically approximate the derivative using `vpa`.

```
dAi = airy(1, sym(0))
dAi_vpa = vpa(dAi)

dAi =
-(3^(1/6)*gamma(2/3))/(2*pi)
dAi_vpa =
-0.2588194037928067984051835601892
```

Find the derivative of the Airy function of the second kind, $Bi'(x)$, at x by specifying the first argument as 3. Then, find the derivative at $x = 5$ by substituting for x using `subs` and calling `vpa`.

```
syms x
dBi = airy(3, x)
dBi_vpa = vpa(subs(dBi, x, 5))

dBi =
airy(3, x)
dBi_vpa =
1435.8190802179825186717212380046
```

Solve Airy Differential Equation for Airy Functions

Show that the Airy functions $Ai(x)$ and $Bi(x)$ are the solutions of the differential equation

$$\frac{\partial^2 y}{\partial x^2} - xy = 0.$$

```
syms y(x)
dsolve(diff(y, 2) - x*y == 0)
```

```
ans =
C1*airy(0, x) + C2*airy(2, x)
```

Differentiate Airy Functions

Differentiate expressions containing `airy`.

```
syms x y
diff(airy(x^2))
diff(diff(airy(3, x^2 + x*y - y^2), x), y)
```

```
ans =
2*x*airy(1, x^2)
```

```
ans =
airy(2, x^2 + x*y - y^2)*(x^2 + x*y - y^2) + ...
airy(2, x^2 + x*y - y^2)*(x - 2*y)*(2*x + y) + ...
airy(3, x^2 + x*y - y^2)*(x - 2*y)*(2*x + y)*(x^2 + x*y - y^2)
```

Expand Airy Function using Taylor Series

Find the Taylor series expansion of the Airy functions, $Ai(x)$ and $Bi(x)$, using `taylor`.

```
aiTaylor = taylor(airy(x))
biTaylor = taylor(airy(2, x))
```

```
aiTaylor =
- (3^(1/6)*gamma(2/3)*x^4)/(24*pi) + (3^(1/3)*x^3)/(18*gamma(2/3))...
- (3^(1/6)*gamma(2/3)*x)/(2*pi) + 3^(1/3)/(3*gamma(2/3))
biTaylor =
(3^(2/3)*gamma(2/3)*x^4)/(24*pi) + (3^(5/6)*x^3)/(18*gamma(2/3))...
+ (3^(2/3)*gamma(2/3)*x)/(2*pi) + 3^(5/6)/(3*gamma(2/3))
```

Fourier Transform of Airy Function

Find the Fourier transform of the Airy function $Ai(x)$ using `fourier`.

```
syms x
aiFourier = fourier(airy(x))
```

```
aiFourier =
exp((w^3*1i)/3)
```

Numeric Roots of Airy Function

Find a root of the Airy function $Ai(x)$ numerically using `vpasolve`.

```
syms x
vpasolve(airy(x) == 0, x)

ans =
-226.99630507523600716771890962744
```

Find a root in the interval [-5 -3].

```
vpasolve(airy(x) == 0, x, [-5 -3])

ans =
-4.0879494441309706166369887014574
```

Input Arguments

x — Input

number | vector | matrix | multidimensional array | symbolic number | symbolic variable | symbolic vector | symbolic matrix | symbolic multidimensional array | symbolic function | symbolic expression

Input, specified as a number, vector, matrix, or multidimensional array, or a symbolic number, variable, vector, matrix, multidimensional array, function, or expression.

n — Type of Airy function

0 (default) | number | vector | matrix | multidimensional array | symbolic number | symbolic variable | symbolic vector | symbolic matrix | symbolic multidimensional array

Type of Airy function, specified as a number, vector, matrix, or multidimensional array, or a symbolic number, variable, vector, matrix, or multidimensional array. The values of the input must be 0, 1, 2, or 3, which specify the Airy function as follows.

n	Returns
0 (default)	Airy function, $Ai(x)$, which is the same as <code>airy(x)</code> .
1	Derivative of Airy function, $Ai'(x)$.
2	Airy function of the second kind, $Bi(x)$.
3	Derivative of Airy function of the second kind, $Bi'(x)$.

More About

Airy Functions

The Airy functions $Ai(x)$ and $Bi(x)$ are the two linearly independent solutions of the differential equation

$$\frac{\partial^2 y}{\partial x^2} - xy = 0.$$

$Ai(x)$ is called the Airy function of the first kind. $Bi(x)$ is called the Airy function of the second kind.

Scaled Airy Functions

The Airy function of the first kind, $Ai(x)$, is scaled as

$$e^{\left(\frac{2}{3}x^{3/2}\right)}Ai(x).$$

The derivative, $Ai'(x)$, is scaled by the same factor.

The Airy function of the second kind, $Bi(x)$, is scaled as

$$e^{-\frac{2}{3}\operatorname{Re}(x^{3/2})}|Bi(x).$$

The derivative, $Bi'(x)$, is scaled by the same factor.

Tips

- When you call `airy` for inputs that are not symbolic objects, you call the MATLAB `airy` function.
- When you call `airy(n, x)`, at least one argument must be a scalar or both arguments must be vectors or matrices of the same size. If one argument is a scalar and the other is a vector or matrix, `airy(n, x)` expands the scalar into a vector or matrix of the same size as the other argument with all elements equal to the scalar.
- `airy` returns special exact values at 0.

See Also

`besseli` | `besselj` | `besselk` | `bessely`

Introduced in R2012a

all

Test whether all equations and inequalities represented as elements of symbolic array are valid

Syntax

```
all(A)
all(A,dim)
```

Description

`all(A)` tests whether all elements of `A` return logical 1 (`true`). If `A` is a matrix, `all` tests all elements of each column. If `A` is a multidimensional array, `all` tests all elements along one dimension.

`all(A,dim)` tests along the dimension of `A` specified by `dim`.

Examples

Test All Elements of Symbolic Vector

Create vector `V` that contains the symbolic equation and inequalities as its elements:

```
syms x
V = [x ~= x + 1, abs(x) >= 0, x == x];
```

Use `all` to test whether all of them are valid for all values of `x`:

```
all(V)

ans =
    logical
     1
```

Test All Elements of Symbolic Matrix

Create this matrix of symbolic equations and inequalities:

```
syms x
M = [x == x, x == abs(x); abs(x) >= 0, x ~= 2*x]

M =
 [      x == x, x == abs(x)]
 [ 0 <= abs(x), x ~= 2*x]
```

Use `all` to test equations and inequalities of this matrix. By default, `all` tests whether all elements of each column are valid for all possible values of variables. If all equations and inequalities in the column are valid (return logical 1), then `all` returns logical 1 for that column. Otherwise, it returns logical 0 for the column. Thus, it returns 1 for the first column and 0 for the second column:

```
all(M)

ans =
    1x2 logical array
     1     0
```

Specify Dimension to Test Along

Create this matrix of symbolic equations and inequalities:

```
syms x
M = [x == x, x == abs(x); abs(x) >= 0, x ~= 2*x]

M =
[      x == x, x == abs(x)]
[ 0 <= abs(x),   x ~= 2*x]
```

For matrices and multidimensional arrays, `all` can test all elements along the specified dimension. To specify the dimension, use the second argument of `all`. For example, to test all elements of each column of a matrix, use the value 1 as the second argument:

```
all(M, 1)

ans =
  1x2 logical array
   1   0
```

To test all elements of each row, use the value 2 as the second argument:

```
all(M, 2)

ans =
  2x1 logical array
   0
   1
```

Test Arrays with Numeric Values

Test whether all elements of this vector return logical 1s. Note that `all` also converts all numeric values outside equations and inequalities to logical 1s and 0s. The numeric value 0 becomes logical 0:

```
syms x
all([0, x == x])

ans =
  logical
   0
```

All nonzero numeric values, including negative and complex values, become logical 1s:

```
all([1, 2, -3, 4 + i, x == x])

ans =
  logical
   1
```

Input Arguments

A — Input

symbolic array

Input, specified as a symbolic array. For example, it can be an array of symbolic equations, inequalities, or logical expressions with symbolic subexpressions.

dim – Dimension

first non-singleton dimension (default) | integer

Dimension, specified as an integer. For example, if *A* is a matrix, `any(A,1)` tests elements of each column and returns a row vector of logical 1s and 0s. `any(A,2)` tests elements of each row and returns a column vector of logical 1s and 0s.

Tips

- If *A* is an empty symbolic array, `all(A)` returns logical 1.
- If some elements of *A* are just numeric values (not equations or inequalities), `all` converts these values as follows. All numeric values except 0 become logical 1. The value 0 becomes logical 0.
- If *A* is a vector and all its elements return logical 1, `all(A)` returns logical 1. If one or more elements are zero, `all(A)` returns logical 0.
- If *A* is a multidimensional array, `all(A)` treats the values along the first dimension that is not equal to 1 (nonsingleton dimension) as vectors, returning logical 1 or 0 for each vector.

See Also

`and` | `any` | `isAlways` | `not` | `or` | `xor`

Introduced in R2012a

and

Logical AND for symbolic expressions

Syntax

```
A & B
and(A,B)
```

Description

$A \& B$ represents the logical AND. $A \& B$ is true only when both A and B are true.

`and(A,B)` is equivalent to $A \& B$.

Examples

Construct and Set Assumptions Using AND

Combine symbolic inequalities into one condition by using `&`.

```
syms x y
cond = x>=0 & y>=0;
```

Set the assumptions represented by the condition using `assume`.

```
assume(cond)
```

Verify that the assumptions are set.

```
assumptions
ans =
[ 0 <= x, 0 <= y]
```

Evaluate Inequalities or Conditions

Define a range for a variable by combining two inequalities into a logical condition using `&`.

```
syms x
range = 0 < x & x < 1;
```

Return the condition at $1/2$ and 10 by substituting for x using `subs`. The `subs` function does not evaluate the conditions automatically.

```
x1 = subs(range,x,1/2)
x2 = subs(range,x,10)
```

```
x1 =
0 < 1/2 & 1/2 < 1
```

```
x2 =  
0 < 10 & 10 < 1
```

Evaluate the inequalities to logical 1 or 0 by using `isAlways`.

```
isAlways(x1)  
isAlways(x2)
```

```
ans =  
    logical  
     1  
ans =  
    logical  
     0
```

Input Arguments

A, B — Operands

symbolic equations | symbolic inequalities | symbolic expressions | symbolic arrays

Operands, specified as symbolic equations, inequalities, expressions, or arrays. Inputs **A** and **B** must either be the same size or have sizes that are compatible (for example, **A** is an **M**-by-**N** matrix and **B** is a scalar or 1-by-**N** row vector). For more information, see “Compatible Array Sizes for Basic Operations” (MATLAB).

Tips

- If you call `simplify` for a logical expression containing symbolic subexpressions, you can get the symbolic constants `symtrue` and `symfalse`. These two constants are not the same as logical 1 (`true`) and logical 0 (`false`). To convert symbolic `symtrue` and `symfalse` to logical values, use `logical`.

Compatibility Considerations

Implicit expansion change affects arguments for operators

Behavior changed in R2016b

Starting in R2016b with the addition of implicit expansion, some combinations of arguments for basic operations that previously returned errors now produce results. For example, you previously could not add a row and a column vector, but those operands are now valid for addition. In other words, an expression like `[1 2] + [1; 2]` previously returned a size mismatch error, but now it executes.

If your code uses element-wise operators and relies on the errors that MATLAB previously returned for mismatched sizes, particularly within a `try/catch` block, then your code might no longer catch those errors.

For more information on the required input sizes for basic array operations, see “Compatible Array Sizes for Basic Operations” (MATLAB).

See Also

`all` | `any` | `isAlways` | `not` | `or` | `piecewise` | `xor`

Introduced in R2012a

angle

Symbolic polar angle

Syntax

```
angle(Z)
```

Description

`angle(Z)` computes the polar angle of the complex value Z .

Examples

Compute Polar Angle of Numeric Inputs

Compute the polar angles of these complex numbers. Because these numbers are not symbolic objects, you get floating-point results.

```
[angle(1 + i), angle(4 + pi*i), angle(Inf + Inf*i)]
```

```
ans =  
    0.7854    0.6658    0.7854
```

Compute Polar Angle of Symbolic Inputs

Compute the polar angles of these complex numbers which are converted to symbolic objects:

```
[angle(sym(1) + i), angle(sym(4) + sym(pi)*i), angle(Inf + sym(Inf)*i)]
```

```
ans =  
[ pi/4, atan(pi/4), pi/4]
```

Compute Polar Angle of Symbolic Expressions

Compute the limits of these symbolic expressions:

```
syms x  
limit(angle(x + x^2*i/(1 + x)), x, -Inf)  
limit(angle(x + x^2*i/(1 + x)), x, Inf)
```

```
ans =  
-(3*pi)/4
```

```
ans =  
pi/4
```

Compute Polar Angle of Array

Compute the polar angles of the elements of matrix Z :

```
Z = sym([sqrt(3) + 3*i, 3 + sqrt(3)*i; 1 + i, i]);  
angle(Z)
```

```
ans =  
[ pi/3, pi/6]  
[ pi/4, pi/2]
```

Input Arguments

Z – Input

number | vector | matrix | array | symbolic number | symbolic array | symbolic function | symbolic expression

Input, specified as a number, vector, matrix, array, or a symbolic number, variable, expression, function.

Tips

- Calling `angle` for numbers (or vectors or matrices of numbers) that are not symbolic objects invokes the MATLAB `angle` function.
- If $Z = 0$, then `angle(Z)` returns 0 .

Alternatives

For real X and Y such that $Z = X + Y*i$, the call `angle(Z)` is equivalent to `atan2(Y,X)`.

See Also

`atan2` | `conj` | `imag` | `real` | `sign` | `signIm`

Introduced in R2013a

animationToFrame

Return structure of frames from animation objects

Syntax

```
frames = animationToFrame
frames = animationToFrame(fig)
frames = animationToFrame( ____,Name,Value)
```

Description

`frames = animationToFrame` returns a structure array of frames from animation objects. The animation objects must be created using the `f Animator` function.

`frames = animationToFrame(fig)` returns a structure array of frames from animation objects in the figure `fig`.

`frames = animationToFrame(____,Name,Value)` uses the specified `Name,Value` pair arguments. Use this option with any of the input argument combinations in the previous syntaxes.

Examples

Return Animation Frames

Create an animation of a moving circle, and return specific frames of the animation.

First, create two symbolic variables, `t` and `x`. The variable `t` defines the time parameter of the animation. Use `t` to set the center of the circle at $(t, 1)$ and `x` to parameterize the perimeter of the circle within the range $[-\pi, \pi]$. Create the circle animation object using `f Animator`. Set the `x`-axis and `y`-axis to be equal length.

```
syms t x
f Animator(@fplot,cos(x)+t,sin(x)+1,[-pi pi])
axis equal
```

By default, `f Animator` generates an animation object with 10 frames per unit time within the range of `t` from 0 to 10. The default animation object contains a total of 101 frames. Use the command `playAnimation` to play the animation.

Next, return a structure array of frames from the animation object by using `animationToFrame`.

```
frames = animationToFrame
```

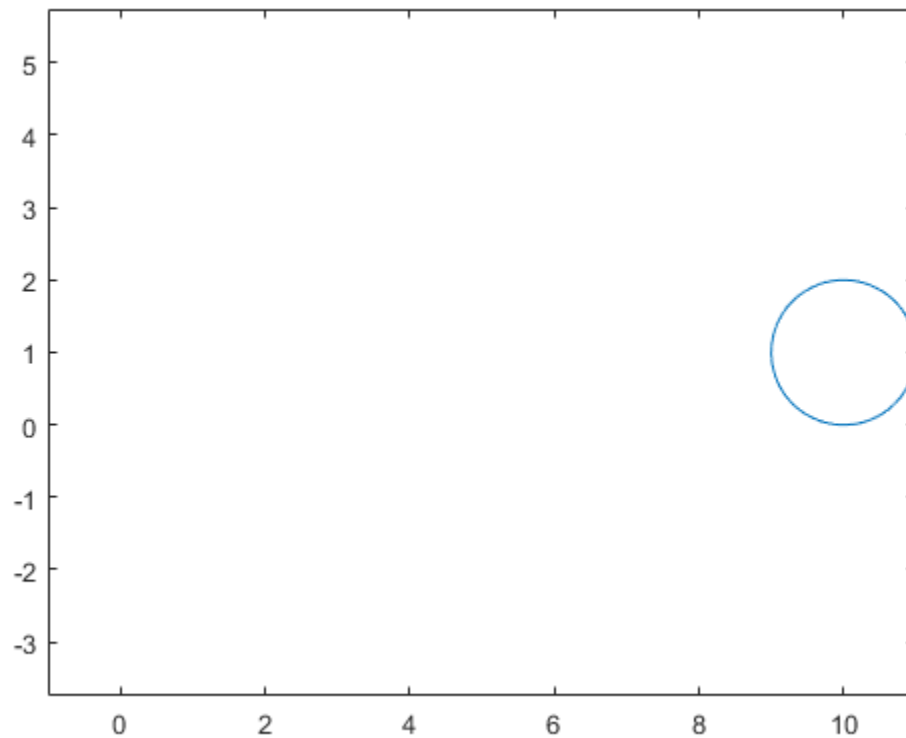

```
frames=1x101 struct array with fields:  
  cdata  
  colormap
```

The structure `frames` contains two fields. The `cdata` field stores the image data as an array of `uint8` values.

Reconstruct the animation frames by using the `imshow` function. For example, display the 50th frame and the last frame of the animation.

```
imshow(frames(50).cdata)
```

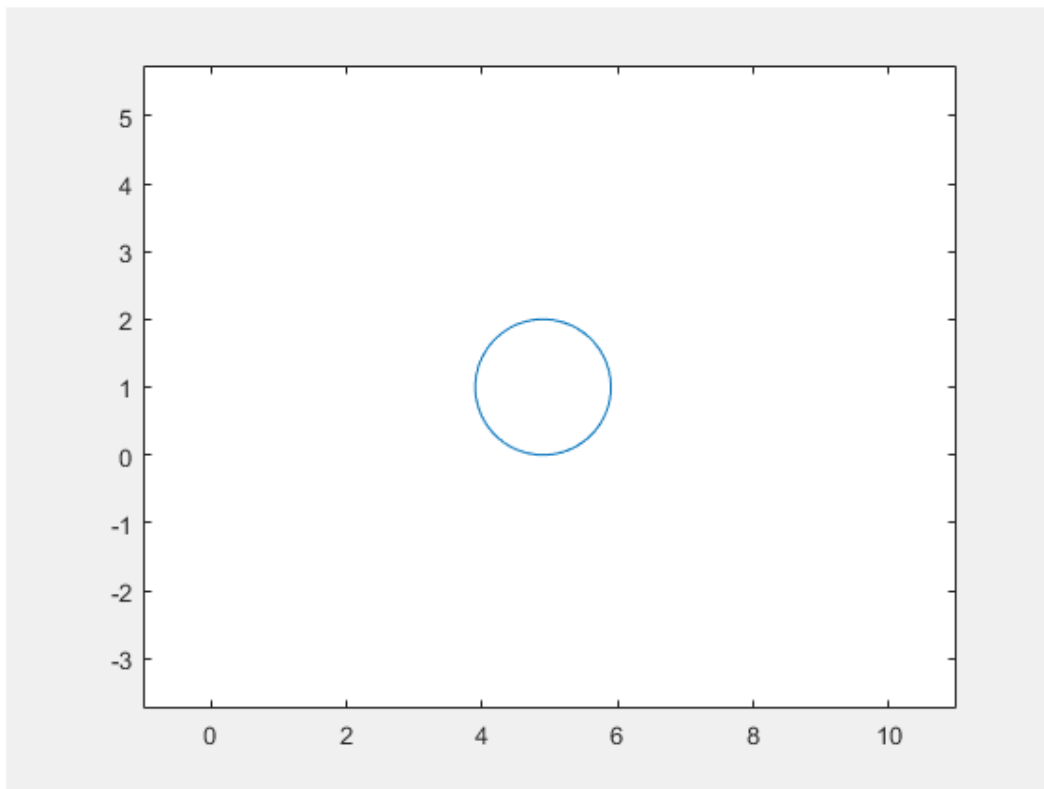

```
imshow(frames(101).cdata)
```

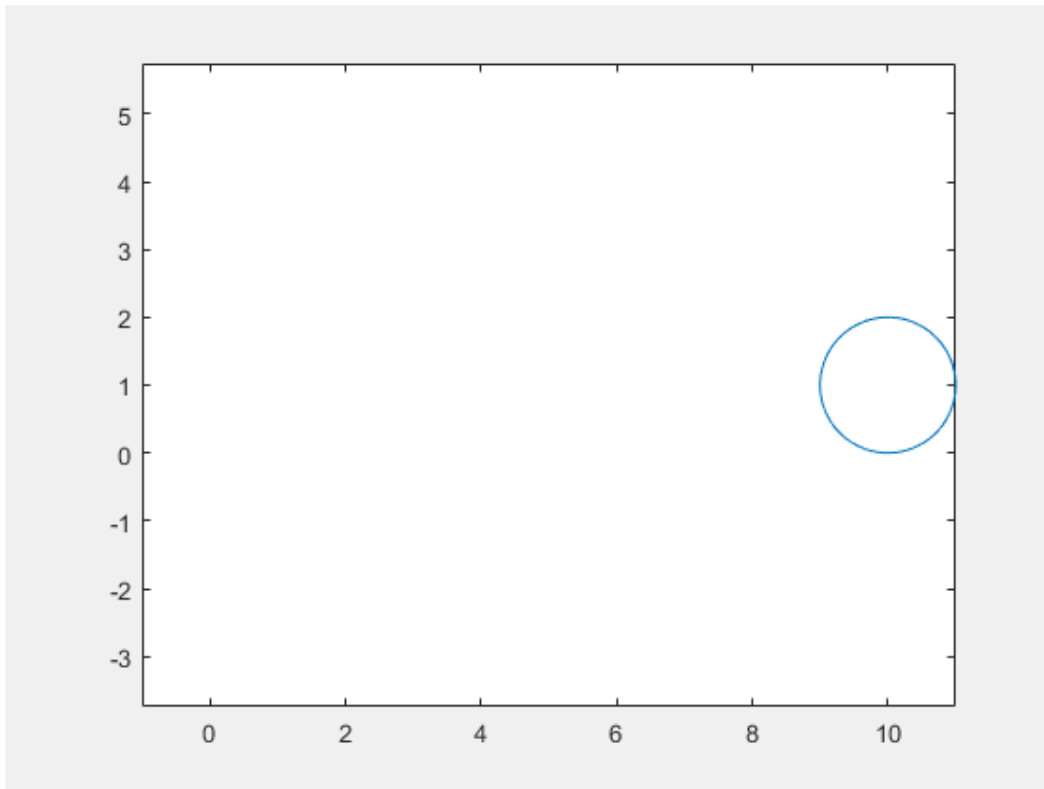
Return Animation Frames in Reverse Order

Create a moving circle animation object and a timer animation object. Return the generated animation frames in reverse order.

First, create two symbolic variables, t and x . The variable t defines the time parameter of the animation. Create a figure window for the animation.

```
syms t x
fig1 = figure;
```

Create a circle animation object using `f animator`. Use t to set the center of the circle at $(t, 1)$ and x to parameterize the perimeter of the circle within the range $[-\pi, \pi]$. Set the x-axis and y-axis to be equal length.

```
f animator(@fplot,cos(x)+t,sin(x)+1,[-pi pi])
axis equal
```

Next, use the `text` function to add a piece of text to count the elapsed time. Use `num2str` to convert the time parameter to a string.

```
hold on
fanimator(@(t) text(8,3,"Timer: "+num2str(t,2)))
hold off
```

By default, `fanimator` creates stop-motion frames with 10 frames per unit time within the range of `t` from 0 to 10. The default animation object contains a total of 101 frames. Use the command `playAnimation` to play the animation.

Next, return a structure array of frames from the animation in figure `fig` by using `animationToFrame`. Return the animation frames in reverse order by setting the `'Backwards'` option to `true`. Set the frame rate per unit time to 2 to return a total of 21 frames.

```
frames = animationToFrame(fig1,'Backwards',true,'FrameRate',2)
```

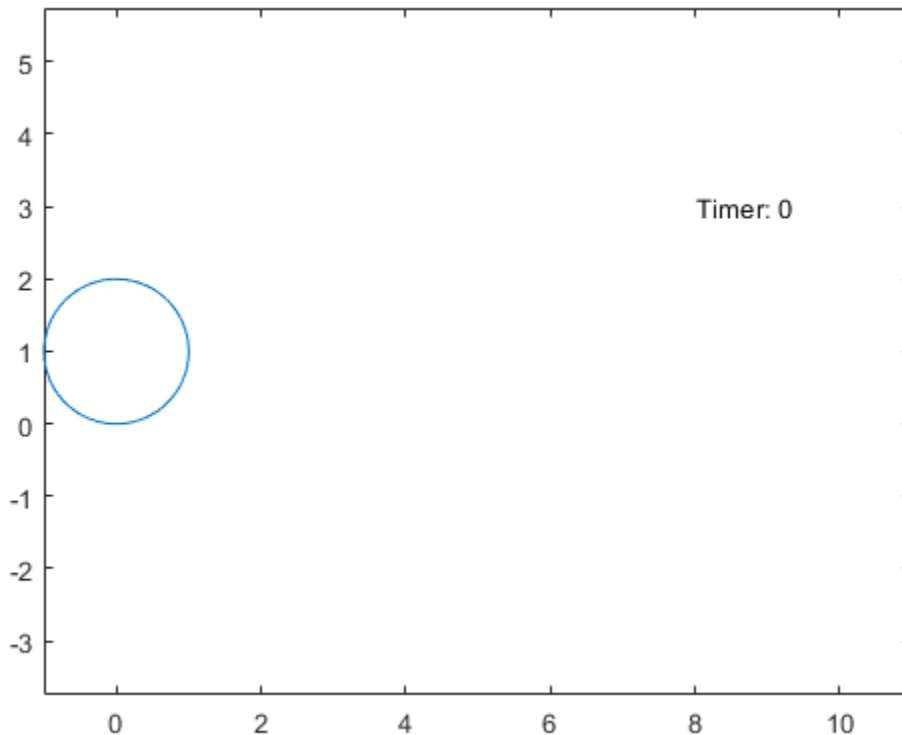

```
frames=1x21 struct array with fields:
    cdata
    colormap
```

The structure `frames` contains two fields. The `cdata` field stores the image data as an array of `uint8` values.

Reconstruct the animation frames by using the `imshow` function. For example, display the first frame and the 11th frame of the animation in a new figure window.

```
fig2 = figure;
imshow(frames(1).cdata)
```

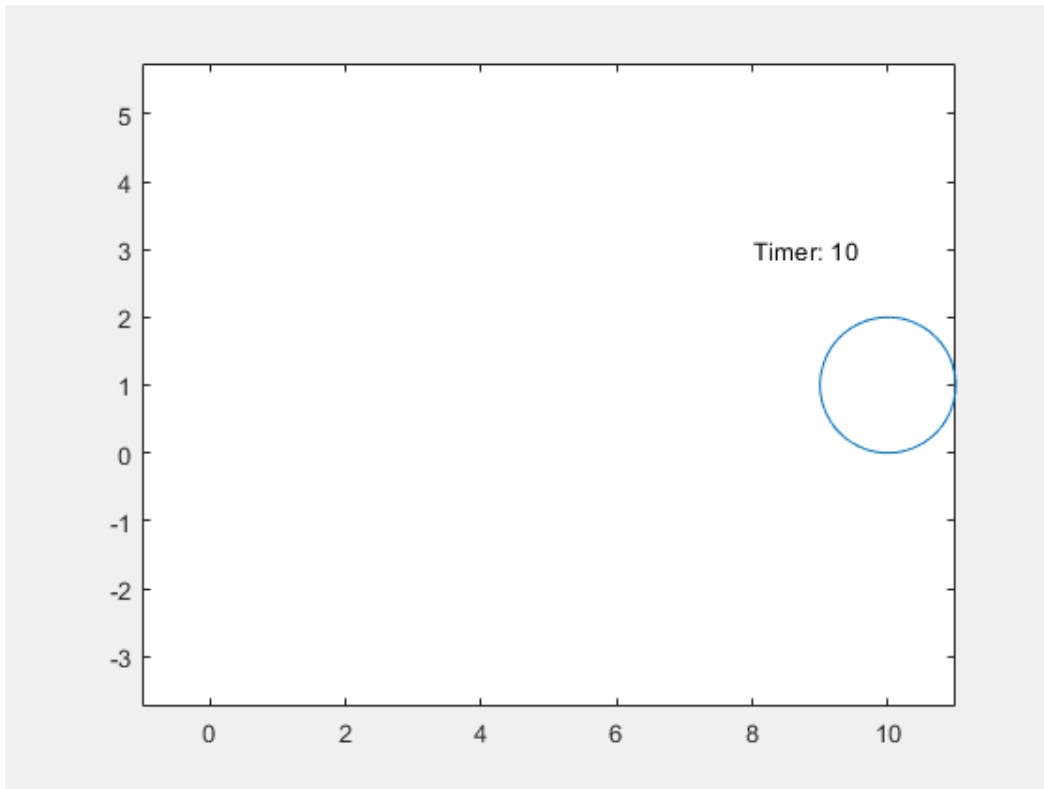

```
imshow(frames(11).cdata)
```

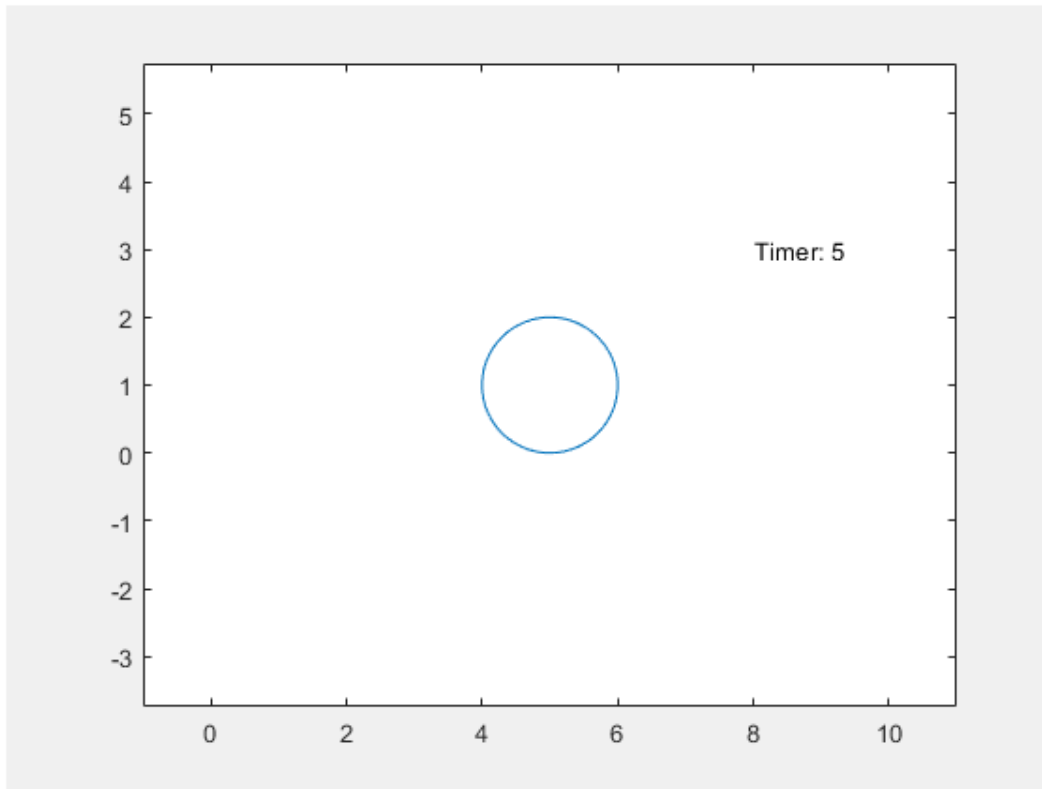

Input Arguments

fig – Target figure

Figure object

Target figure, specified as a Figure object. For more information about Figure objects, see `figure`.

Name-Value Pair Arguments

Specify optional comma-separated pairs of `Name`, `Value` arguments. `Name` is the argument name and `Value` is the corresponding value. `Name` must appear inside quotes. You can specify several name and value pair arguments in any order as `Name1`, `Value1`, ..., `NameN`, `ValueN`.

Example: `'Backwards',true,'AnimationRange',[-2 5]`

AnimationRange – Range of animation time parameter

`[0 10]` (default) | two-element row vector

Range of the animation time parameter, specified as a two-element row vector. The two elements must be real values that are increasing.

Example: `[-2 4.5]`

FrameRate — Frame rate

10 (default) | positive value

Frame rate, specified as a positive value. The frame rate defines the number of frames per unit time when you returning animation frames as a structure array.

Example: 20

Backwards — Backward option

logical 0 (false) (default) | logical value

Backward option, specified as a logical value (boolean). If you specify `true`, then the function returns the animation frames backwards or in reverse order.

Example: `true`

Output Arguments**frames — Animation frames**

structure array

Animation frames, returned as a structure array with two fields:

- `cdata` — The image data stored as an array of `uint8` values. The size of the image data array depends on your screen resolution.
- `colormap` — The colormap. On true color systems, this field is empty.

The `animationToFrame` function returns a structure of animation frames in the same format as the output returned by the `getframe` function.

See Also

`f Animator` | `getframe` | `playAnimation` | `rewindAnimation` | `writeAnimation`

Introduced in R2019a

Animator Properties

Animator appearance and behavior

Note `UIContextMenu` property is not recommended. Use `ContextMenu` instead. For more information, see “Compatibility Considerations”.

Description

Animator properties control the appearance and behavior of an Animator object. By changing property values, you can modify certain aspects of the Animator object. You can use dot notation to refer to a particular object and property:

```
fp = f animator(@ (x) plot(x, sin(x), 'bo'))
ls = fp.Visible
fp.Visible = 'off'
```

Properties

Frames

AnimationRange — Range of animation time parameter

[0 10] (default) | two-element row vector

This property is read-only.

Range of the animation time parameter, specified as a two-element row vector. The two elements must be real values that are increasing.

FrameRate — Frame rate

10 (default) | positive value

This property is read-only.

Frame rate, specified as a positive value. The frame rate defines the number of frames per unit time interval of an animation object.

Interactivity

Visible — State of visibility

'on' (default) | on/off logical value

State of visibility, specified as 'on' or 'off', or as numeric or logical 1 (true) or 0 (false). A value of 'on' is equivalent to true, and 'off' is equivalent to false. Thus, you can use the value of this property as a logical value. The value is stored as an on/off logical value of type `matlab.lang.OnOffSwitchState`.

- 'on' — Display the object.
- 'off' — Hide the object without deleting it. You still can access the properties of an invisible object.

ContextMenu — Context menu

empty GraphicsPlaceholder array (default) | ContextMenu object

Context menu, specified as a ContextMenu object. Use this property to display a context menu when you right-click the object. Create the context menu using the `uicontextmenu` function.

Callbacks**ButtonDownFcn — Mouse-click callback**

' ' (default) | function handle | cell array | character vector

Mouse-click callback, specified as one of these values:

- Function handle.
- Cell array containing a function handle and additional arguments.
- Character vector that is a valid MATLAB command or function, which is evaluated in the base workspace (not recommended).

Use this property to execute code when you click the object. If you specify this property using a function handle, then MATLAB passes two arguments to the callback function when executing the callback:

- Clicked object — Access properties of the clicked object from within the callback function.
- Event data — Empty argument. Replace it with the tilde character (~) in the function definition to indicate that this argument is not used.

For more information on how to use function handles to define callback functions, see “Callback Definition” (MATLAB).

CreateFcn — Creation function

' ' (default) | function handle | cell array | character vector

Object creation function, specified as one of these values:

- Function handle.
- Cell array in which the first element is a function handle. Subsequent elements in the cell array are the arguments to pass to the callback function.
- Character vector containing a valid MATLAB expression (not recommended). MATLAB evaluates this expression in the base workspace.

For more information about specifying a callback as a function handle, cell array, or character vector, see “Callback Definition” (MATLAB).

This property specifies a callback function to execute when MATLAB creates the object. MATLAB initializes all property values before executing the CreateFcn callback. If you do not specify the CreateFcn property, then MATLAB executes a default creation function.

Setting the CreateFcn property on an existing component has no effect.

If you specify this property as a function handle or cell array, you can access the object that is being created using the first argument of the callback function. Otherwise, use the `gcbo` function to access the object.

DeleteFcn — Deletion function`' '` (default) | function handle | cell array | character vector

Object deletion function, specified as one of these values:

- Function handle.
- Cell array in which the first element is a function handle. Subsequent elements in the cell array are the arguments to pass to the callback function.
- Character vector containing a valid MATLAB expression (not recommended). MATLAB evaluates this expression in the base workspace.

For more information about specifying a callback as a function handle, cell array, or character vector, see “Callback Definition” (MATLAB).

This property specifies a callback function to execute when MATLAB deletes the object. MATLAB executes the `DeleteFcn` callback before destroying the properties of the object. If you do not specify the `DeleteFcn` property, then MATLAB executes a default deletion function.

If you specify this property as a function handle or cell array, you can access the object that is being deleted using the first argument of the callback function. Otherwise, use the `gcbo` function to access the object.

Callback Execution Control**Interruptible — Callback interruption**`'on'` (default) | on/off logical value

Callback interruption, specified as `'on'` or `'off'`, or as numeric or logical 1 (true) or 0 (false). A value of `'on'` is equivalent to `true`, and `'off'` is equivalent to `false`. Thus, you can use the value of this property as a logical value. The value is stored as an on/off logical value of type `matlab.lang.OnOffSwitchState`.

This property determines if a running callback can be interrupted. There are two callback states to consider:

- The running callback is the currently executing callback.
- The interrupting callback is a callback that tries to interrupt the running callback.

Whenever MATLAB invokes a callback, that callback attempts to interrupt the running callback (if one exists). The `Interruptible` property of the object owning the running callback determines if interruption is allowed.

- A value of `'on'` allows other callbacks to interrupt the object's callbacks. The interruption occurs at the next point where MATLAB processes the queue, such as when there is a `drawnow`, `figure`, `uifigure`, `getframe`, `waitfor`, or `pause` command.
 - If the running callback contains one of those commands, then MATLAB stops the execution of the callback at that point and executes the interrupting callback. MATLAB resumes executing the running callback when the interrupting callback completes.
 - If the running callback does not contain one of those commands, then MATLAB finishes executing the callback without interruption.
- A value of `'off'` blocks all interruption attempts. The `BusyAction` property of the object owning the interrupting callback determines if the interrupting callback is discarded or put into a queue.

Note Callback interruption and execution behave differently in these situations:

- If the interrupting callback is a `DeleteFcn`, `CloseRequestFcn` or `SizeChangedFcn` callback, then the interruption occurs regardless of the `Interruptible` property value.
- If the running callback is currently executing the `waitfor` function, then the interruption occurs regardless of the `Interruptible` property value.
- Timer objects execute according to schedule regardless of the `Interruptible` property value.

When an interruption occurs, MATLAB does not save the state of properties or the display. For example, the object returned by the `gca` or `gcf` command might change when another callback executes.

BusyAction — Callback queuing

'queue' (default) | 'cancel'

Callback queuing, specified as 'queue' or 'cancel'. The `BusyAction` property determines how MATLAB handles the execution of interrupting callbacks. There are two callback states to consider:

- The running callback is the currently executing callback.
- The interrupting callback is a callback that tries to interrupt the running callback.

Whenever MATLAB invokes a callback, that callback attempts to interrupt a running callback. The `Interruptible` property of the object owning the running callback determines if interruption is permitted. If interruption is not permitted, then the `BusyAction` property of the object owning the interrupting callback determines if it is discarded or put in the queue. These are possible values of the `BusyAction` property:

- 'queue' — Puts the interrupting callback in a queue to be processed after the running callback finishes execution.
- 'cancel' — Does not execute the interrupting callback.

BeingDeleted — Deletion status

on/off logical value

This property is read-only.

Deletion status, returned as an on/off logical value of type `matlab.lang.OnOffSwitchState`.

MATLAB sets the `BeingDeleted` property to 'on' when the `DeleteFcn` callback begins execution. The `BeingDeleted` property remains set to 'on' until the component object no longer exists.

Check the value of the `BeingDeleted` property to verify that the object is not about to be deleted before querying or modifying it.

Parent/Child

Parent — Parent

Axes object

Parent, specified as an Axes object.

Children — Children

graphics object

Children, returned as a graphics object. Use this property to view the property values of the graphics object.

You cannot add or remove children using the Children property. You can only set Children to a permutation of itself.

HandleVisibility — Visibility of object handle

'on' (default) | 'off' | 'callback'

Visibility of the object handle in the Children property of the parent, specified as one of these values:

- 'on' — Object handle is always visible.
- 'off' — Object handle is invisible at all times. This option is useful for preventing unintended changes to the UI by another function. Set the HandleVisibility to 'off' to temporarily hide the handle during the execution of that function.
- 'callback' — Object handle is visible from within callbacks or functions invoked by callbacks, but not from within functions invoked from the command line. This option blocks access to the object at the command line, but permits callback functions to access it.

If the object is not listed in the Children property of the parent, then functions that obtain object handles by searching the object hierarchy or querying handle properties cannot return it. Examples of such functions include the `get`, `findobj`, `gca`, `gcf`, `gco`, `newplot`, `cla`, `clf`, and `close` functions.

Hidden object handles are still valid. Set the root `ShowHiddenHandles` property to 'on' to list all object handles regardless of their HandleVisibility property setting.

Identifier

Type — Type of graphics object

'animator'

This property is read-only.

Type of graphics object, returned as 'animator'. Use this property to find all objects of a given type within a plotting hierarchy. For example, you can use the `findobj` function to find graphics objects of type 'animator'.

Tag — Object identifier

'' (default) | character vector | string scalar

Object identifier, specified as a character vector or string scalar. You can specify a unique Tag value to serve as an identifier for an object. When you need access to the object elsewhere in your code, you can use the `findobj` function to search for the object based on the Tag value.

UserData — User data

[] (default) | array

User data, specified as any MATLAB array. For example, you can specify a scalar, vector, matrix, cell array, character array, table, or structure. Use this property to store arbitrary data on an object.

If you are working in App Designer, create public or private properties in the app to share data instead of using the UserData property. For more information, see “Share Data Within App Designer Apps” (MATLAB).

Compatibility Considerations

UIContextMenu property is not recommended

Not recommended starting in R2020a

Starting in R2020a, using the `UIContextMenu` property to assign a context menu to a graphics object or UI component is not recommended. Use the `ContextMenu` property instead. The property values are the same.

There are no plans to remove support for the `UIContextMenu` property at this time. However, the `UIContextMenu` property no longer appears in the list returned by calling the `get` function on a graphics object or UI component.

See Also

Introduced in R2019a

any

Test whether at least one of equations and inequalities represented as elements of symbolic array is valid

Syntax

```
any(A)
any(A,dim)
```

Description

`any(A)` tests whether at least one element of `A` returns logical 1 (`true`). If `A` is a matrix, `any` tests elements of each column. If `A` is a multidimensional array, `any` tests elements along one dimension.

`any(A,dim)` tests along the dimension of `A` specified by `dim`.

Examples

Test Vector of Symbolic Conditions

Create vector `V` that contains the symbolic equation and inequalities as its elements:

```
syms x real
V = [x ~= x + 1, abs(x) >= 0, x == x];
```

Use `any` to test whether at least one of them is valid for all values of `x`:

```
any(V)

ans =
    logical
     1
```

Test Matrix of Symbolic Conditions

Create this matrix of symbolic equations and inequalities:

```
syms x real
M = [x == 2*x, x == abs(x); abs(x) >= 0, x == 2*x]

M =
 [ x == 2*x, x == abs(x) ]
 [ 0 <= abs(x), x == 2*x ]
```

Use `any` to test equations and inequalities of this matrix. By default, `any` tests whether any element of each column is valid for all possible values of variables. If at least one equation or inequality in the column is valid (returns logical 1), then `any` returns logical 1 for that column. Otherwise, it returns logical 0 for the column. Thus, it returns 1 for the first column and 0 for the second column:

```
any(M)
```

```
ans =
  1x2 logical array
   1   0
```

Specify Dimension to Test Along

Create this matrix of symbolic equations and inequalities:

```
syms x real
M = [x == 2*x, x == abs(x); abs(x) >= 0, x == 2*x]

M =
 [ x == 2*x, x == abs(x)]
 [ 0 <= abs(x), x == 2*x]
```

For matrices and multidimensional arrays, `any` can test elements along the specified dimension. To specify the dimension, use the second argument of `any`. For example, to test elements of each column of a matrix, use the value 1 as the second argument:

```
any(M, 1)

ans =
  1x2 logical array
   1   0
```

To test elements of each row, use the value 2 as the second argument:

```
any(M, 2)

ans =
  2x1 logical array
   0
   1
```

Test Arrays with Numeric Values

Test whether any element of this vector returns logical 1. Note that `any` also converts all numeric values outside equations and inequalities to logical 1s and 0s. The numeric value 0 becomes logical 0:

```
syms x
any([0, x == x + 1])

ans =
  logical
   0
```

All nonzero numeric values, including negative and complex values, become logical 1s:

```
any([-4 + i, x == x + 1])

ans =
  logical
   1
```

Input Arguments

A — Input

symbolic array

Input, specified as a symbolic array. For example, it can be an array of symbolic equations, inequalities, or logical expressions with symbolic subexpressions.

dim – Dimension

first non-singleton dimension (default) | integer

Dimension, specified as an integer. For example, if *A* is a matrix, `any(A, 1)` tests elements of each column and returns a row vector of logical 1s and 0s. `any(A, 2)` tests elements of each row and returns a column vector of logical 1s and 0s.

Tips

- If *A* is an empty symbolic array, `any(A)` returns logical 0.
- If some elements of *A* are just numeric values (not equations or inequalities), `any` converts these values as follows. All nonzero numeric values become logical 1. The value 0 becomes logical 0.
- If *A* is a vector and any of its elements returns logical 1, `any(A)` returns logical 1. If all elements are zero, `any(A)` returns logical 0.
- If *A* is a multidimensional array, `any(A)` treats the values along the first dimension that is not equal to 1 (non-singleton dimension) as vectors, returning logical 1 or 0 for each vector.

See Also

`all` | `and` | `isAlways` | `not` | `or` | `xor`

Introduced in R2012a

argnames

Input variables of symbolic function

Syntax

```
argnames(f)
```

Description

`argnames(f)` returns input variables of `f`.

Examples

Find Input Variables of Symbolic Function

Create this symbolic function:

```
syms f(x, y)
f(x, y) = x + y;
```

Use `argnames` to find input variables of `f`:

```
argnames(f)
```

```
ans =
 [ x, y]
```

Create this symbolic function:

```
syms f(a, b, x, y)
f(x, b, y, a) = a*x + b*y;
```

Use `argnames` to find input variables of `f`. When returning variables, `argnames` uses the same order as you used when you defined the function:

```
argnames(f)
```

```
ans =
 [ x, b, y, a]
```

Input Arguments

f — Input

symbolic function

Input, specified as a symbolic function.

See Also

`formula` | `sym` | `syms` | `symvar`

Introduced in R2012a

asec

Symbolic inverse secant function

Syntax

`asec(X)`

Description

`asec(X)` returns the inverse secant function (arcsecant function) of X . All angles are in radians.

- For real elements of X in the interval $[-\text{Inf}, -1]$ and $[1, \text{Inf}]$, `asec` returns values in the interval $[0, \pi]$.
- For real values of X in the interval $[-1, 1]$ and for complex values of X , `asec` returns complex values with the real parts in the interval $[0, \pi]$.

Examples

Inverse Secant Function for Numeric and Symbolic Arguments

Depending on its arguments, `asec` returns floating-point or exact symbolic results.

Compute the inverse secant function for these numbers. Because these numbers are not symbolic objects, `asec` returns floating-point results.

```
A = asec([-2, 0, 2/sqrt(3), 1/2, 1, 5])
```

```
A =
    2.0944 + 0.0000i    0.0000 +    Inf    0.5236 + 0.0000i...
    0.0000 + 1.3170i    0.0000 + 0.0000i    1.3694 + 0.0000i
```

Compute the inverse secant function for the numbers converted to symbolic objects. For many symbolic (exact) numbers, `asec` returns unresolved symbolic calls.

```
symA = asec(sym([-2, 0, 2/sqrt(3), 1/2, 1, 5]))
```

```
symA =
[ (2*pi)/3, Inf, pi/6, acos(2), 0, acos(1/5)]
```

Use `vpa` to approximate symbolic results with floating-point numbers:

```
vpa(symA)
```

```
ans =
[ 2.0943951023931954923084289221863,...
  Inf,...
  0.52359877559829887307710723054658,...
  1.3169578969248165734029498707969i,...
  0,...
  1.3694384060045659001758622252964]
```

Plot Inverse Secant Function

Plot the inverse secant function on the interval from -10 to 10.

```
syms x
fplot(asec(x), [-10 10])
grid on
```

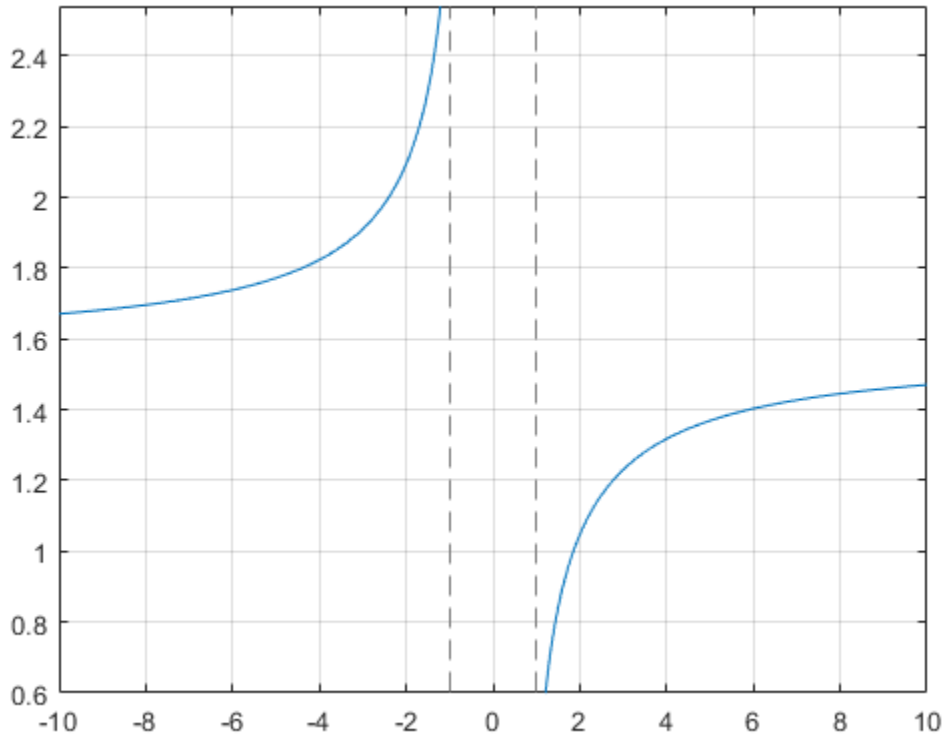

Handle Expressions Containing Inverse Secant Function

Many functions, such as `diff`, `int`, `taylor`, and `rewrite`, can handle expressions containing `asec`.

Find the first and second derivatives of the inverse secant function:

```
syms x
diff(asec(x), x)
diff(asec(x), x, x)
```

```
ans =
1/(x^2*(1 - 1/x^2)^(1/2))
```

```
ans =
- 2/(x^3*(1 - 1/x^2)^(1/2)) - 1/(x^5*(1 - 1/x^2)^(3/2))
```

Find the indefinite integral of the inverse secant function:

```
int(asec(x), x)
```

```
ans =
x*acos(1/x) - log(x + (x^2 - 1)^(1/2))*sign(x)
```

Find the Taylor series expansion of `asec(x)` around `x = Inf`:

```
taylor(asec(x), x, Inf)
```

```
ans =
pi/2 - 1/x - 1/(6*x^3) - 3/(40*x^5)
```

Rewrite the inverse secant function in terms of the natural logarithm:

```
rewrite(asec(x), 'log')
```

```
ans =
-log(1/x + (1 - 1/x^2)^(1/2)*1i)*1i
```

Input Arguments

X — Input

symbolic number | symbolic variable | symbolic expression | symbolic function | symbolic vector | symbolic matrix

Input, specified as a symbolic number, variable, expression, or function, or as a vector or matrix of symbolic numbers, variables, expressions, or functions.

See Also

`acos` | `acot` | `acsc` | `asin` | `atan` | `cos` | `cot` | `csc` | `sec` | `sin` | `tan`

Introduced before R2006a

asech

Symbolic inverse hyperbolic secant function

Syntax

`asech(X)`

Description

`asech(X)` returns the inverse hyperbolic secant function of X .

Examples

Inverse Hyperbolic Secant Function for Numeric and Symbolic Arguments

Depending on its arguments, `asech` returns floating-point or exact symbolic results.

Compute the inverse hyperbolic secant function for these numbers. Because these numbers are not symbolic objects, `asech` returns floating-point results.

```
A = asech([-2, 0, 2/sqrt(3), 1/2, 1, 3])
```

```
A =
    0.0000 + 2.0944i      Inf + 0.0000i    0.0000 + 0.5236i...
    1.3170 + 0.0000i    0.0000 + 0.0000i    0.0000 + 1.2310i
```

Compute the inverse hyperbolic secant function for the numbers converted to symbolic objects. For many symbolic (exact) numbers, `asech` returns unresolved symbolic calls.

```
symA = asech(sym([-2, 0, 2/sqrt(3), 1/2, 1, 3]))
```

```
symA =
[ (pi*2i)/3, Inf, (pi*1i)/6, acosh(2), 0, acosh(1/3)]
```

Use `vpa` to approximate symbolic results with floating-point numbers:

```
vpa(symA)
```

```
ans =
[ 2.0943951023931954923084289221863i,...
  Inf,...
  0.52359877559829887307710723054658i,...
  1.316957896924816708625046347308,...
  0,...
  1.230959417340774682134929178248i]
```

Plot Inverse Hyperbolic Secant Function

Plot the inverse hyperbolic secant function on the interval from 0 to 1.

```
syms x
fplot(asech(x),[0 1])
grid on
```

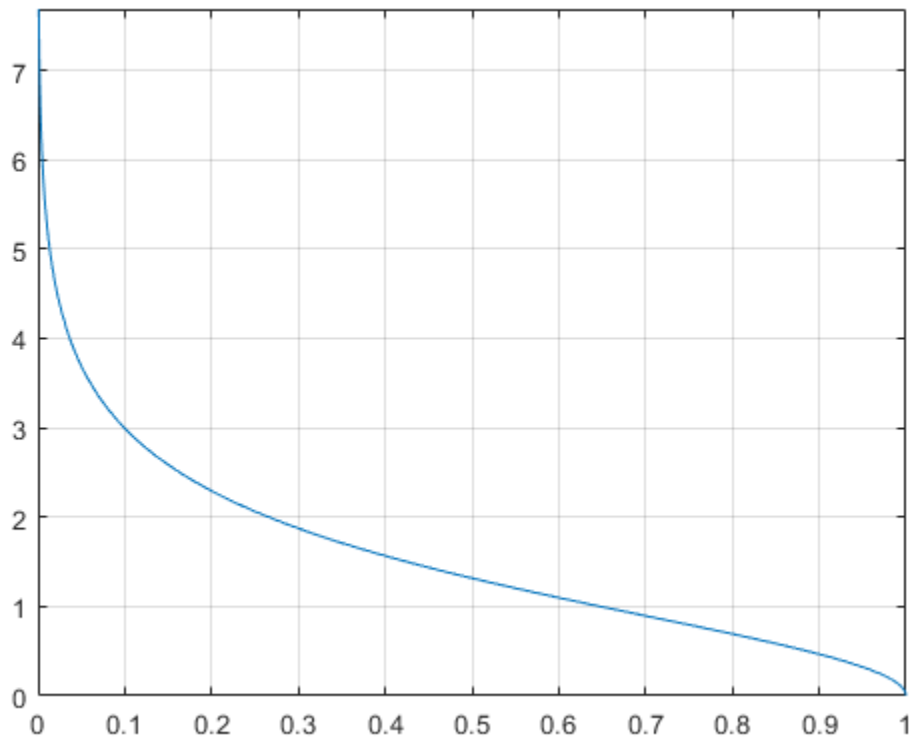

Handle Expressions Containing Inverse Hyperbolic Secant Function

Many functions, such as `diff`, `int`, `taylor`, and `rewrite`, can handle expressions containing `asech`.

Find the first and second derivatives of the inverse hyperbolic secant function. Simplify the second derivative by using `simplify`.

```
syms x
diff(asech(x), x)
simplify(diff(asech(x), x, x))

ans =
-1/(x^2*(1/x - 1)^(1/2)*(1/x + 1)^(1/2))
```

```
ans =
-(2*x^2 - 1)/(x^5*(1/x - 1)^(3/2)*(1/x + 1)^(3/2))
```

Find the indefinite integral of the inverse hyperbolic secant function:

```
int(asech(x), x)

ans =
atan(1/((1/x - 1)^(1/2)*(1/x + 1)^(1/2))) + x*acosh(1/x)
```

Find the Taylor series expansion of `asech(x)` around `x = Inf`:

```
taylor(asech(x), x, Inf)
```

```
ans =  
(pi*1i)/2 - 1i/x - 1i/(6*x^3) - 3i/(40*x^5)
```

Rewrite the inverse hyperbolic secant function in terms of the natural logarithm:

```
rewrite(asech(x), 'log')
```

```
ans =  
log((1/x - 1)^(1/2)*(1/x + 1)^(1/2) + 1/x)
```

Input Arguments

X — Input

symbolic number | symbolic variable | symbolic expression | symbolic function | symbolic vector | symbolic matrix

Input, specified as a symbolic number, variable, expression, or function, or as a vector or matrix of symbolic numbers, variables, expressions, or functions.

See Also

acosh | acoth | acsch | asinh | atanh | cosh | coth | csch | sech | sinh | tanh

Introduced before R2006a

asin

Symbolic inverse sine function

Syntax

`asin(X)`

Description

`asin(X)` returns the inverse sine function (arcsine function) of X . All angles are in radians.

- For real values of X in the interval $[-1, 1]$, `asin(X)` returns the values in the interval $[-\pi/2, \pi/2]$.
- For real values of X outside the interval $[-1, 1]$ and for complex values of X , `asin(X)` returns complex values with the real parts in the interval $[-\pi/2, \pi/2]$.

Examples

Inverse Sine Function for Numeric and Symbolic Arguments

Depending on its arguments, `asin` returns floating-point or exact symbolic results.

Compute the inverse sine function for these numbers. Because these numbers are not symbolic objects, `asin` returns floating-point results.

```
A = asin([-1, -1/3, -1/2, 1/4, 1/2, sqrt(3)/2, 1])
```

```
A =
    -1.5708    -0.3398    -0.5236     0.2527     0.5236     1.0472     1.5708
```

Compute the inverse sine function for the numbers converted to symbolic objects. For many symbolic (exact) numbers, `asin` returns unresolved symbolic calls.

```
symA = asin(sym([-1, -1/3, -1/2, 1/4, 1/2, sqrt(3)/2, 1]))
```

```
symA =
[ -pi/2, -asin(1/3), -pi/6, asin(1/4), pi/6, pi/3, pi/2]
```

Use `vpa` to approximate symbolic results with floating-point numbers:

```
vpa(symA)
```

```
ans =
[ -1.5707963267948966192313216916398, ...
  -0.33983690945412193709639251339176, ...
  -0.52359877559829887307710723054658, ...
   0.25268025514207865348565743699371, ...
   0.52359877559829887307710723054658, ...
   1.0471975511965977461542144610932, ...
   1.5707963267948966192313216916398]
```

Plot Inverse Sine Function

Plot the inverse sine function on the interval from -1 to 1.

```
syms x
fplot(asin(x), [-1 1])
grid on
```

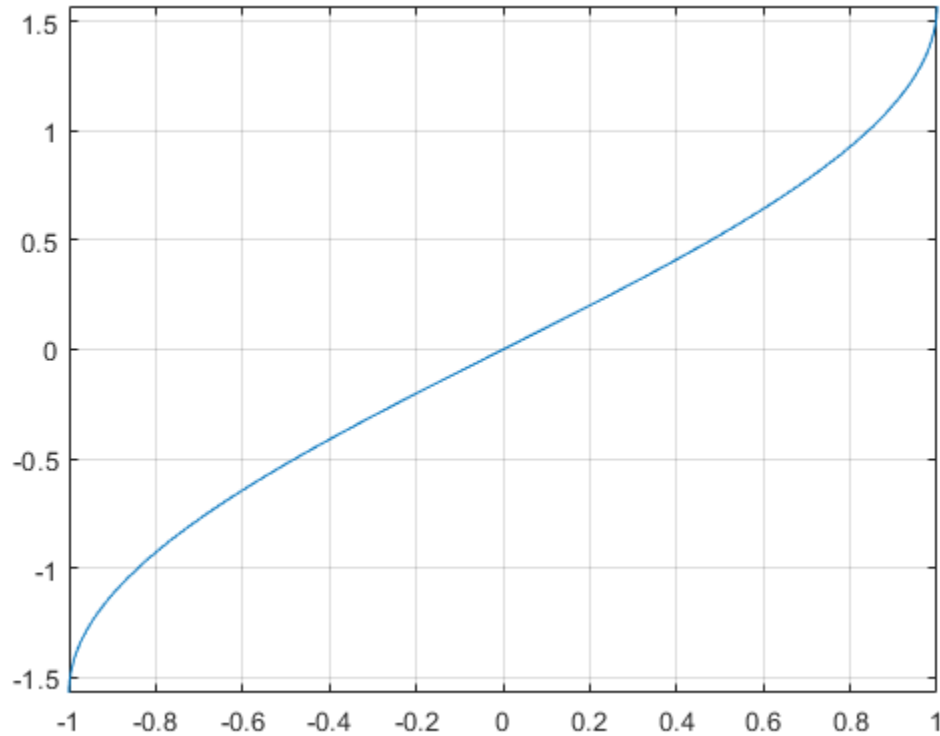

Handle Expressions Containing Inverse Sine Function

Many functions, such as `diff`, `int`, `taylor`, and `rewrite`, can handle expressions containing `asin`.

Find the first and second derivatives of the inverse sine function:

```
syms x
diff(asin(x), x)
diff(asin(x), x, x)
```

```
ans =
1/(1 - x^2)^(1/2)
```

```
ans =
x/(1 - x^2)^(3/2)
```

Find the indefinite integral of the inverse sine function:

```
int(asin(x), x)
```



```
ans =  
x*asin(x) + (1 - x^2)^(1/2)
```

Find the Taylor series expansion of `asin(x)`:

```
taylor(asin(x), x)
```

```
ans =  
(3*x^5)/40 + x^3/6 + x
```

Rewrite the inverse sine function in terms of the natural logarithm:

```
rewrite(asin(x), 'log')
```

```
ans =  
-log((1 - x^2)^(1/2) + x*1i)*1i
```

Input Arguments

X — Input

symbolic number | symbolic variable | symbolic expression | symbolic function | symbolic vector | symbolic matrix

Input, specified as a symbolic number, variable, expression, or function, or as a vector or matrix of symbolic numbers, variables, expressions, or functions.

See Also

`acos` | `acot` | `acsc` | `asec` | `atan` | `cos` | `cot` | `csc` | `sec` | `sin` | `tan`

Introduced before R2006a

asinh

Symbolic inverse hyperbolic sine function

Syntax

```
asinh(X)
```

Description

`asinh(X)` returns the inverse hyperbolic sine function of X .

Examples

Inverse Hyperbolic Sine Function for Numeric and Symbolic Arguments

Depending on its arguments, `asinh` returns floating-point or exact symbolic results.

Compute the inverse hyperbolic sine function for these numbers. Because these numbers are not symbolic objects, `asinh` returns floating-point results.

```
A = asinh([-i, 0, 1/6, i/2, i, 2])
```

```
A =
    0.0000 - 1.5708i    0.0000 + 0.0000i    0.1659 + 0.0000i...
    0.0000 + 0.5236i    0.0000 + 1.5708i    1.4436 + 0.0000i
```

Compute the inverse hyperbolic sine function for the numbers converted to symbolic objects. For many symbolic (exact) numbers, `asinh` returns unresolved symbolic calls.

```
symA = asinh(sym([-i, 0, 1/6, i/2, i, 2]))
```

```
symA =
[ -(pi*1i)/2, 0, asinh(1/6), (pi*1i)/6, (pi*1i)/2, asinh(2)]
```

Use `vpa` to approximate symbolic results with floating-point numbers:

```
vpa(symA)
```

```
ans =
[ -1.5707963267948966192313216916398i,...
  0,...
  0.16590455026930117643502171631553,...
  0.52359877559829887307710723054658i,...
  1.5707963267948966192313216916398i,...
  1.4436354751788103012444253181457]
```

Plot Inverse Hyperbolic Sine Function

Plot the inverse hyperbolic sine function on the interval from -10 to 10.

```
syms x
fplot(asinh(x),[-10 10])
grid on
```

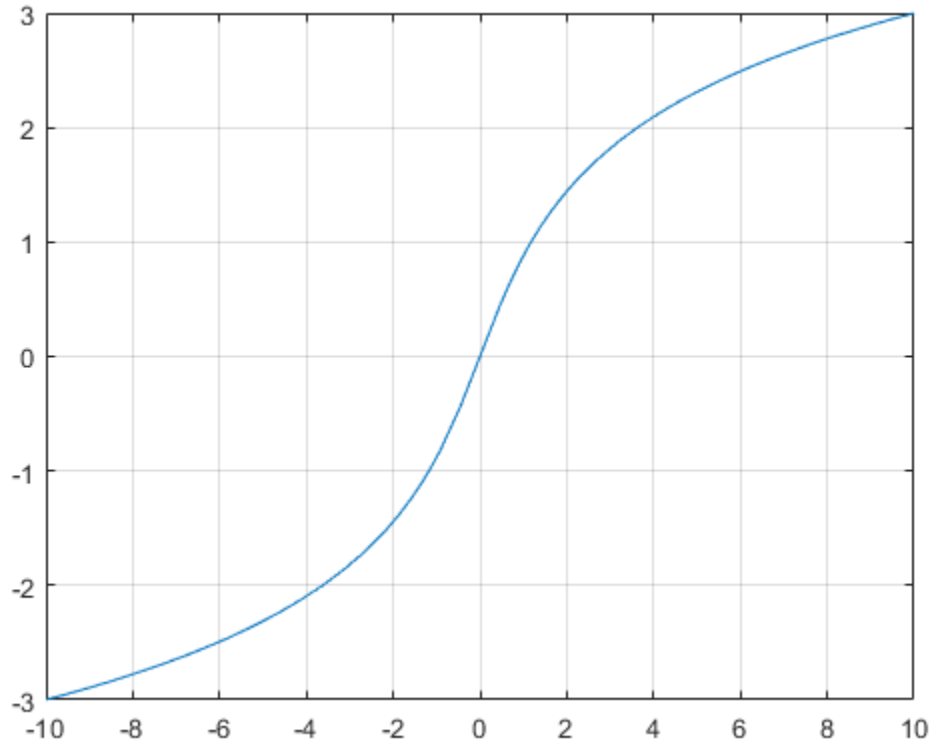

Handle Expressions Containing Inverse Hyperbolic Sine Function

Many functions, such as `diff`, `int`, `taylor`, and `rewrite`, can handle expressions containing `asinh`.

Find the first and second derivatives of the inverse hyperbolic sine function:

```
syms x
diff(asinh(x), x)
diff(asinh(x), x, x)
```

```
ans =
1/(x^2 + 1)^(1/2)
```

```
ans =
-x/(x^2 + 1)^(3/2)
```

Find the indefinite integral of the inverse hyperbolic sine function:

```
int(asinh(x), x)
```

```
ans =
x*asinh(x) - (x^2 + 1)^(1/2)
```

Find the Taylor series expansion of `asinh(x)`:

```
taylor(asinh(x), x)
```

```
ans =  
(3*x^5)/40 - x^3/6 + x
```

Rewrite the inverse hyperbolic sine function in terms of the natural logarithm:

```
rewrite(asinh(x), 'log')
```

```
ans =  
log(x + (x^2 + 1)^(1/2))
```

Input Arguments

X — Input

symbolic number | symbolic variable | symbolic expression | symbolic function | symbolic vector | symbolic matrix

Input, specified as a symbolic number, variable, expression, or function, or as a vector or matrix of symbolic numbers, variables, expressions, or functions.

See Also

acosh | acoth | acsch | asech | atanh | cosh | coth | csch | sech | sinh | tanh

Introduced before R2006a

assume

Set assumption on symbolic object

Syntax

```
assume(condition)
assume(expr, set)
assume(expr, 'clear')
```

Description

`assume(condition)` states that `condition` is valid. `assume` is not additive. Instead, it automatically deletes all previous assumptions on the variables in `condition`.

`assume(expr, set)` states that `expr` belongs to `set`. `assume` deletes previous assumptions on variables in `expr`.

`assume(expr, 'clear')` clears all assumptions on all variables in `expr`.

Examples

Common Assumptions

Set an assumption using the associated syntax.

Assume 'x' is	Syntax
real	<code>assume(x, 'real')</code>
rational	<code>assume(x, 'rational')</code>
positive	<code>assume(x, 'positive')</code>
positive integer	<code>assume(x, {'positive', 'integer'})</code>
less than -1 or greater than 1	<code>assume(x < -1 x > 1)</code>
an integer from 2 through 10	<code>assume(in(x, 'integer') & x > 2 & x < 10)</code>
not an integer	<code>assume(~in(z, 'integer'))</code>
not equal to 0	<code>assume(x ~= 0)</code>
even	<code>assume(x/2, 'integer')</code>
odd	<code>assume((x-1)/2, 'integer')</code>
from 0 through 2π	<code>assume(x > 0 & x < 2*pi)</code>
a multiple of π	<code>assume(x/pi, 'integer')</code>

Assume Variable Is Even or Odd

Assume x is even by assuming that $x/2$ is an integer. Assume x is odd by assuming that $(x-1)/2$ is an integer.

Assume x is even.

```
syms x
assume(x/2, 'integer')
```

Find all even numbers between 0 and 10 using `solve`.

```
solve(x>0,x<10,x)
```

```
ans =
 2
 4
 6
 8
```

Assume x is odd. `assume` is not additive, but instead automatically deletes the previous assumption `in(x/2, 'integer')`.

```
assume((x-1)/2, 'integer')
solve(x>0,x<10,x)
```

```
ans =
 1
 3
 5
 7
 9
```

Clear the assumptions on x for further computations.

```
assume(x, 'clear')
```

Multiple Assumptions

Successive `assume` commands do not set multiple assumptions. Instead, each `assume` command deletes previous assumptions and sets new assumptions. Set multiple assumptions by using `assumeAlso` or the `&` operator.

Assume $x > 5$ and then $x < 10$ by using `assume`. Use assumptions to check that only the second assumption exists because `assume` deleted the first assumption when setting the second.

```
syms x
assume(x > 5)
assume(x < 10)
assumptions
```

```
ans =
x < 10
```

Assume the first assumption in addition to the second by using `assumeAlso`. Check that both assumptions exist.

```
assumeAlso(x > 5)
assumptions
```

```
ans =
[ 5 < x, x < 10]
```

Clear the assumptions on x .

```
assume(x, 'clear')
```

Assume both conditions using the & operator. Check that both assumptions exist.

```
assume(x>5 & x<10)
assumptions
```

```
ans =
[ 5 < x, x < 10]
```

Clear the assumptions on x for future calculations.

```
assume(x, 'clear')
```

Assumptions on Integrand

Compute an indefinite integral with and without the assumption on the symbolic parameter a.

Use `assume` to set an assumption that a does not equal -1.

```
syms x a
assume(a ~= -1)
```

Compute this integral.

```
int(x^a,x)

ans =
x^(a + 1)/(a + 1)
```

Now, clear the assumption and compute the same integral. Without assumptions, `int` returns this piecewise result.

```
assume(a, 'clear')
int(x^a, x)

ans =
piecewise(a == -1, log(x), a ~= -1, x^(a + 1)/(a + 1))
```

Assumptions on Parameters and Variables of Equation

Use assumptions to restrict the returned solutions of an equation to a particular interval.

Solve this equation.

```
syms x
eqn = x^5 - (565*x^4)/6 - (1159*x^3)/2 - (2311*x^2)/6 + (365*x)/2 + 250/3;
solve(eqn, x)
```

```
ans =
-5
-1
-1/3
1/2
100
```

Use `assume` to restrict the solutions to the interval $-1 \leq x \leq 1$.

```
assume(-1 <= x <= 1)
solve(eqn, x)

ans =
-1
```

```
-1/3  
1/2
```

Set several assumptions simultaneously by using the logical operators `and`, `or`, `xor`, `not`, or their shortcuts. For example, all negative solutions less than -1 and all positive solutions greater than 1 .

```
assume(x < -1 | x > 1)  
solve(eqn, x)
```

```
ans =  
-5  
100
```

For further computations, clear the assumptions.

```
assume(x, 'clear')
```

Use Assumptions for Simplification

Setting appropriate assumptions can result in simpler expressions.

Try to simplify the expression $\sin(2\pi n)$ using `simplify`. The `simplify` function cannot simplify the input and returns the input as it is.

```
syms n  
simplify(sin(2*n*pi))
```

```
ans =  
sin(2*pi*n)
```

Assume n is an integer. `simplify` now simplifies the expression.

```
assume(n, 'integer')  
simplify(sin(2*n*pi))
```

```
ans =  
0
```

For further computations, clear the assumption.

```
assume(n, 'clear')
```

Assumptions on Expressions

Set assumption on the symbolic expression.

You can set assumptions not only on variables, but also on expressions. For example, compute this integral.

```
syms x  
f = 1/abs(x^2 - 1);  
int(f,x)
```

```
ans =  
-atanh(x)/sign(x^2 - 1)
```

Set the assumption $x^2 - 1 > 0$ to produce a simpler result.

```
assume(x^2 - 1 > 0)  
int(f,x)
```



```
ans =
-atanh(x)
```

For further computations, clear the assumption.

```
assume(x, 'clear')
```

Assumptions to Prove Relations

Prove relations that hold under certain conditions by first assuming the conditions and then using `isAlways`.

Prove that $\sin(\pi x)$ is never equal to 0 when x is not an integer. The `isAlways` function returns logical 1 (true), which means the condition holds for all values of x under the set assumptions.

```
syms x
assume(~in(x, 'integer'))
isAlways(sin(pi*x) ~= 0)
```

```
ans =
    logical
     1
```

Assumptions on Matrix Elements

Set assumptions on all elements of a matrix using `sym`.

Create the 2-by-2 symbolic matrix A with auto-generated elements. Specify the set as `rational`.

```
A = sym('A', [2 2], 'rational')
```

```
A =
 [ A1_1, A1_2]
 [ A2_1, A2_2]
```

Return the assumptions on the elements of A using `assumptions`.

```
assumptions(A)

ans =
 [ in(A1_1, 'rational'), in(A1_2, 'rational'),...
  in(A2_1, 'rational'), in(A2_2, 'rational')]
```

You can also use `assume` to set assumptions on all elements of a matrix. Now, assume all elements of A have positive rational values. Set the assumptions as a cell of character vectors `{'positive', 'rational'}`.

```
assume(A, {'positive', 'rational'})
```

Return the assumptions on the elements of A using `assumptions`.

```
assumptions(A)

ans =
 [ 0 < A1_1, 0 < A1_2, 0 < A2_1, 0 < A2_2,...
  in(A1_1, 'rational'), in(A1_2, 'rational'),...
  in(A2_1, 'rational'), in(A2_2, 'rational')]
```

For further computations, clear the assumptions.

```
assume(A, 'clear')
```

Input Arguments

condition — Assumption statement

symbolic expression | symbolic equation | symbolic relation | vector or matrix of symbolic expressions, equations, or relations

Assumption statement, specified as a symbolic expression, equation, relation, or vector or matrix of symbolic expressions, equations, or relations. You also can combine several assumptions by using the logical operators `and`, `or`, `xor`, `not`, or their shortcuts.

expr — Expression to set assumption on

symbolic variable | symbolic expression | vector or matrix of symbolic variables or expressions

Expression to set assumption on, specified as a symbolic variable, expression, vector, or matrix. If `expr` is a vector or matrix, then `assume(expr, set)` sets an assumption that each element of `expr` belongs to `set`.

set — Set of assumptions

character vector | string array | cell array

Set of assumptions, specified as a character vector, string array, or cell array. The available assumptions are `'integer'`, `'rational'`, `'real'`, or `'positive'`.

You can combine multiple assumptions by specifying a string array or cell array of character vectors. For example, assume a positive rational value by specifying `set` as `["positive" "rational"]` or `{'positive', 'rational'}`.

Tips

- `assume` removes any assumptions previously set on the symbolic variables. To retain previous assumptions while adding an assumption, use `assumeAlso`.
- When you delete a symbolic variable from the MATLAB workspace using `clear`, all assumptions that you set on that variable remain in the symbolic engine. If you later declare a new symbolic variable with the same name, it inherits these assumptions.
- To clear all assumptions set on a symbolic variable `var`, use this command.

```
assume(var, 'clear')
```

- To delete all objects in the MATLAB workspace and close the Symbolic Math Toolbox engine associated with the MATLAB workspace clearing all assumptions, use this command:

```
clear all
```

- MATLAB projects complex numbers in inequalities to the real axis. If `condition` is an inequality, then both sides of the inequality must represent real values. Inequalities with complex numbers are invalid because the field of complex numbers is not an ordered field. (It is impossible to tell whether $5 + i$ is greater or less than $2 + 3i$.) For example, $x > i$ becomes $x > 0$, and $x \leq 3 + 2i$ becomes $x \leq 3$.
- The toolbox does not support assumptions on symbolic functions. Make assumptions on symbolic variables and expressions instead.
- When you create a new symbolic variable using `sym` and `syms`, you also can set an assumption that the variable is real, positive, integer, or rational.

```
a = sym('a', 'real');  
b = sym('b', 'rational');  
c = sym('c', 'positive');  
d = sym('d', 'positive');  
e = sym('e', {'positive', 'integer'});
```

or more efficiently

```
syms a real  
syms b rational  
syms c d positive  
syms e positive integer
```

See Also

[and](#) | [assumeAlso](#) | [assumptions](#) | [in](#) | [isAlways](#) | [not](#) | [or](#) | [piecewise](#) | [sym](#) | [syms](#)

Topics

“Set Assumptions” on page 1-24

“Check Existing Assumptions” on page 1-25

“Delete Symbolic Objects and Their Assumptions” on page 1-25

“Default Assumption” on page 1-24

Introduced in R2012a

assumeAlso

Add assumption on symbolic object

Syntax

```
assumeAlso(condition)
assumeAlso(expr, set)
```

Description

`assumeAlso(condition)` states that `condition` is valid for all symbolic variables in `condition`. It retains all assumptions previously set on these symbolic variables.

`assumeAlso(expr, set)` states that `expr` belongs to `set`, in addition to all previously made assumptions.

Examples

Assumptions Specified as Relations

Set assumptions using `assume`. Then add more assumptions using `assumeAlso`.

Solve this equation assuming that both `x` and `y` are nonnegative.

```
syms x y
assume(x >= 0 & y >= 0)
s = solve(x^2 + y^2 == 1, y)
```

```
Warning: Solutions are valid under the following
conditions: x <= 1;
x == 1.
```

```
To include parameters and conditions in the
solution, specify the 'ReturnConditions' value as
'true'.
```

```
> In solve>warnIfParams (line 482)
In solve (line 357)
```

```
s =
(1 - x)^(1/2)*(x + 1)^(1/2)
-(1 - x)^(1/2)*(x + 1)^(1/2)
```

The solver warns that both solutions hold only under certain conditions.

Add the assumption that `x < 1`. To add a new assumption without removing the previous one, use `assumeAlso`.

```
assumeAlso(x < 1)
```

Solve the same equation under the expanded set of assumptions.

```
s = solve(x^2 + y^2 == 1, y)
```

```
s =
(1 - x)^(1/2)*(x + 1)^(1/2)
```

For further computations, clear the assumptions.

```
assume([x y], 'clear')
```

Assumptions Specified as Sets

Set assumptions using `syms`. Then add more assumptions using `assumeAlso`.

When declaring the symbolic variable `n`, set an assumption that `n` is positive.

```
syms n positive
```

Using `assumeAlso`, add more assumptions on the same variable `n`. For example, assume also that `n` is an integer.

```
assumeAlso(n, 'integer')
```

Return all assumptions affecting variable `n` using `assumptions`. In this case, `n` is a positive integer.

```
assumptions(n)
ans =
[ 0 < n, in(n, 'integer')]
```

For further computations, clear the assumptions.

```
assume(n, 'clear')
```

Assumptions on Matrix Elements

Use the assumption on a matrix as a shortcut for setting the same assumption on each matrix element.

Create the 3-by-3 symbolic matrix `A` with auto-generated elements. To assume every element of `A` is rational, specify `set` as `'rational'`.

```
A = sym('A', [3 3], 'rational')
```

```
A =
[ A1_1, A1_2, A1_3]
[ A2_1, A2_2, A2_3]
[ A3_1, A3_2, A3_3]
```

Now, add the assumption that each element of `A` is greater than 1.

```
assumeAlso(A > 1)
```

Return assumptions affecting elements of `A` using `assumptions`:

```
assumptions(A)
ans =
[ 1 < A1_1, 1 < A1_2, 1 < A1_3, 1 < A2_1, 1 < A2_2, 1 < A2_3,...
 1 < A3_1, 1 < A3_2, 1 < A3_3,...
 in(A1_1, 'rational'), in(A1_2, 'rational'), in(A1_3, 'rational'),...
 in(A2_1, 'rational'), in(A2_2, 'rational'), in(A2_3, 'rational'),...
 in(A3_1, 'rational'), in(A3_2, 'rational'), in(A3_3, 'rational')]
```

For further computations, clear the assumptions.

```
assume(A, 'clear')
```

Contradicting Assumptions

When you add assumptions, ensure that the new assumptions do not contradict the previous assumptions. Contradicting assumptions can lead to inconsistent and unpredictable results. In some cases, `assumeAlso` detects conflicting assumptions and issues an error.

Try to set contradicting assumptions. `assumeAlso` returns an error.

```
syms y
assume(y, 'real')
assumeAlso(y == i)

Error using mupadengine/feval (line 172)
Inconsistent assumptions.
Error in sym/assumeAlso (line 627)
    feval(symengine, 'assumeAlso', cond);
```

`assumeAlso` does not guarantee to detect contradicting assumptions. For example, assume that y is nonzero, and both y and $y*i$ are real values.

```
syms y
assume(y ~= 0)
assumeAlso(y, 'real')
assumeAlso(y*i, 'real')
```

Return all assumptions affecting variable y using `assumptions`:

```
assumptions(y)

ans =
[ in(y, 'real'), in(y*i, 'real'), y ~= 0]
```

For further computations, clear the assumptions.

```
assume(y, 'clear')
```

Input Arguments

condition — Assumption statement

symbolic expression | symbolic equation | relation | vector or matrix of symbolic expressions, equations, or relations

Assumption statement, specified as a symbolic expression, equation, relation, or vector or matrix of symbolic expressions, equations, or relations. You also can combine several assumptions by using the logical operators `and`, `or`, `xor`, `not`, or their shortcuts.

expr — Expression to set assumption on

symbolic variable | symbolic expression | vector or matrix of symbolic variables or expressions

Expression to set assumption on, specified as a symbolic variable, expression, or a vector or matrix of symbolic variables or expressions. If `expr` is a vector or matrix, then `assumeAlso(expr, set)` sets an assumption that each element of `expr` belongs to `set`.

set — Set of assumptions

character vector | string array | cell array

Set of assumptions, specified as a character vector, string array, or cell array. The available assumptions are 'integer', 'rational', 'real', or 'positive'.

You can combine multiple assumptions by specifying a string array or cell array of character vectors. For example, assume a positive rational value by specifying set as ["positive" "rational"] or {'positive','rational'}.

Tips

- `assumeAlso` keeps all assumptions previously set on the symbolic variables. To replace previous assumptions with the new one, use `assume`.
- When adding assumptions, always check that a new assumption does not contradict the existing assumptions. To see existing assumptions, use `assumptions`. Symbolic Math Toolbox does not guarantee to detect conflicting assumptions. Conflicting assumptions can lead to unpredictable and inconsistent results.
- When you delete a symbolic variable from the MATLAB workspace using `clear`, all assumptions that you set on that variable remain in the symbolic engine. If later you declare a new symbolic variable with the same name, it inherits these assumptions.
- To clear all assumptions set on a symbolic variable `var` use this command.

```
assume(var, 'clear')
```

- To clear all objects in the MATLAB workspace and close the Symbolic Math Toolbox engine associated with the MATLAB workspace resetting all its assumptions, use this command.

```
clear all
```

- MATLAB projects complex numbers in inequalities to the real axis. If `condition` is an inequality, then both sides of the inequality must represent real values. Inequalities with complex numbers are invalid because the field of complex numbers is not an ordered field. (It is impossible to tell whether $5 + i$ is greater or less than $2 + 3i$.) For example, $x > i$ becomes $x > 0$, and $x \leq 3 + 2i$ becomes $x \leq 3$.
- The toolbox does not support assumptions on symbolic functions. Make assumptions on symbolic variables and expressions instead.
- Instead of adding assumptions one by one, you can set several assumptions in one function call. To set several assumptions, use `assume` and combine these assumptions by using the logical operators `and`, `or`, `xor`, `not`, `all`, `any`, or their shortcuts.

See Also

`and` | `assume` | `assumptions` | `in` | `isAlways` | `not` | `or` | `piecewise` | `sym` | `syms`

Topics

"Set Assumptions" on page 1-24

"Check Existing Assumptions" on page 1-25

"Delete Symbolic Objects and Their Assumptions" on page 1-25

"Default Assumption" on page 1-24

Introduced in R2012a

assumptions

Show assumptions affecting symbolic variable, expression, or function

Syntax

```
assumptions(var)
assumptions
```

Description

`assumptions(var)` returns all assumptions that affect variable `var`. If `var` is an expression or function, `assumptions` returns all assumptions that affect all variables in `var`.

`assumptions` returns all assumptions that affect all variables in MATLAB Workspace.

Examples

Assumptions on Variables

Assume that the variable `n` is an integer using `assume`. Return the assumption using `assumptions`.

```
syms n
assume(n,'integer')
assumptions
```

```
ans =
in(n, 'integer')
```

The syntax `in(n, 'integer')` indicates `n` is an integer.

Assume that `n` is less than `x` and that `x < 42` using `assume`. The `assume` function replaces old assumptions on input with the new assumptions. Return all assumptions that affect `n`.

```
syms x
assume(n<x & x<42)
assumptions(n)
```

```
ans =
[ n < x, x < 42]
```

`assumptions` returns the assumption `x < 42` because it affects `n` through the assumption `n < x`. Thus, `assumptions` returns the transitive closure of assumptions, which is all assumptions that mathematically affect the input.

Set the assumption on variable `m` that `1 < m < 3`. Return all assumptions on `m` and `x` using `assumptions`.

```
syms m
assume(1<m<3)
assumptions([m x])
```

```
ans =
[ n < x, 1 < m, m < 3, x < 42]
```

To see the assumptions that affect all variables, use `assumptions` without any arguments.

```
assumptions
ans =
[ n < x, 1 < m, m < 3, x < 42]
```

For further computations, clear the assumptions.

```
assume([m n x], 'clear')
```

Multiple Assumptions on One Variable

You cannot set an additional assumption on a variable using `assume` because `assume` clears all previous assumptions on that variable. To set an additional assumption on a variable, using `assumeAlso`.

Set an assumption on x using `assume`. Set an additional assumption on x use `assumeAlso`. Use `assumptions` to return the multiple assumptions on x .

```
syms x
assume(x, 'real')
assumeAlso(x < 0)
assumptions(x)
ans =
[ in(x, 'real'), x < 0]
```

The syntax `in(x, 'real')` indicates x is real.

For further computations, clear the assumptions.

```
assume(x, 'clear')
```

Assumptions Affecting Expressions and Functions

`assumptions` accepts symbolic expressions and functions as input and returns all assumptions that affect all variables in the symbolic expressions or functions.

Set assumptions on variables in a symbolic expression. Find all assumptions that affect all variables in the symbolic expression using `assumptions`.

```
syms a b c
expr = a*exp(b)*sin(c);
assume(a+b > 3 & in(a, 'integer') & in(c, 'real'))
assumptions(expr)
ans =
[ 3 < a + b, in(a, 'integer'), in(c, 'real')]
```

Find all assumptions that affect all variables that are inputs to a symbolic function.

```
syms f(a,b,c)
assumptions(f)
ans =
[ 3 < a + b, in(a, 'integer'), in(c, 'real')]
```

Clear the assumptions for further computations.

```
assume([a b c], 'clear')
```

Restore Old Assumptions

To restore old assumptions, first store the assumptions returned by `assumptions`. Then you can restore these assumptions at any point by calling `assume` or `assumeAlso`.

Solve the equation for a spring using `dsolve` under the assumptions that the mass and spring constant are **positive**.

```
syms m k positive
syms x(t)
dsolve(m*diff(x,t,t) == -k*x, x(0)==0)
```

```
ans =
C8*sin((k^(1/2)*t)/m^(1/2))
```

Suppose you want to explore solutions unconstrained by assumptions, but want to restore the assumptions afterwards. First store the assumptions using `assumptions`, then clear the assumptions and solve the equation. `dsolve` returns unconstrained solutions.

```
tmp = assumptions;
assume([m k], 'clear')
dsolve(m*diff(x,t,t) == -k*x, x(0)==0)

ans =
C10*exp((t*(-k*m)^(1/2))/m) + C10*exp(-(t*(-k*m)^(1/2))/m)
```

Restore the original assumptions using `assume`.

```
assume(tmp)
```

After computations are complete, clear assumptions using `assume`.

```
assume([m k], 'clear')
```

Input Arguments

var — Symbolic input to check for assumptions

symbolic variable | symbolic expression | symbolic function | symbolic vector | symbolic matrix | symbolic multidimensional array

Symbolic input for which to show assumptions, specified as a symbolic variable, expression, or function, or a vector, matrix, or multidimensional array of symbolic variables, expressions, or functions.

Tips

- When you delete a symbolic object from the MATLAB workspace by using `clear`, all assumptions that you set on that object remain in the symbolic engine. If you declare a new symbolic variable with the same name, it inherits these assumptions.
- To clear all assumptions set on a symbolic variable `var` use this command.

```
assume(var, 'clear')
```

- To clear all objects in the MATLAB workspace and close the Symbolic Math Toolbox engine associated with the MATLAB workspace resetting all its assumptions, use this command.

clear `all`

See Also

and | assume | assumeAlso | clear | in | isAlways | not | or | piecewise | sym | syms

Topics

“Set Assumptions” on page 1-24

“Check Existing Assumptions” on page 1-25

“Delete Symbolic Objects and Their Assumptions” on page 1-25

“Default Assumption” on page 1-24

Introduced in R2012a

atan

Symbolic inverse tangent function

Syntax

`atan(X)`

Description

`atan(X)` returns the inverse tangent function (arctangent function) of X . All angles are in radians.

- For real values of X , `atan(X)` returns values in the interval $[-\pi/2, \pi/2]$.
- For complex values of X , `atan(X)` returns complex values with the real parts in the interval $[-\pi/2, \pi/2]$.

Examples

Inverse Tangent Function for Numeric and Symbolic Arguments

Depending on its arguments, `atan` returns floating-point or exact symbolic results.

Compute the inverse tangent function for these numbers. Because these numbers are not symbolic objects, `atan` returns floating-point results.

```
A = atan([-1, -1/3, -1/sqrt(3), 1/2, 1, sqrt(3)])
A =
    -0.7854    -0.3218    -0.5236     0.4636     0.7854     1.0472
```

Compute the inverse tangent function for the numbers converted to symbolic objects. For many symbolic (exact) numbers, `atan` returns unresolved symbolic calls.

```
symA = atan(sym([-1, -1/3, -1/sqrt(3), 1/2, 1, sqrt(3)]))
symA =
[ -pi/4, -atan(1/3), -pi/6, atan(1/2), pi/4, pi/3]
```

Use `vpa` to approximate symbolic results with floating-point numbers:

```
vpa(symA)
ans =
[ -0.78539816339744830961566084581988, ...
 -0.32175055439664219340140461435866, ...
 -0.52359877559829887307710723054658, ...
 0.46364760900080611621425623146121, ...
 0.78539816339744830961566084581988, ...
 1.0471975511965977461542144610932]
```

Plot Inverse Tangent Function

Plot the inverse tangent function on the interval from -10 to 10.

```
syms x
fplot(atan(x), [-10 10])
grid on
```

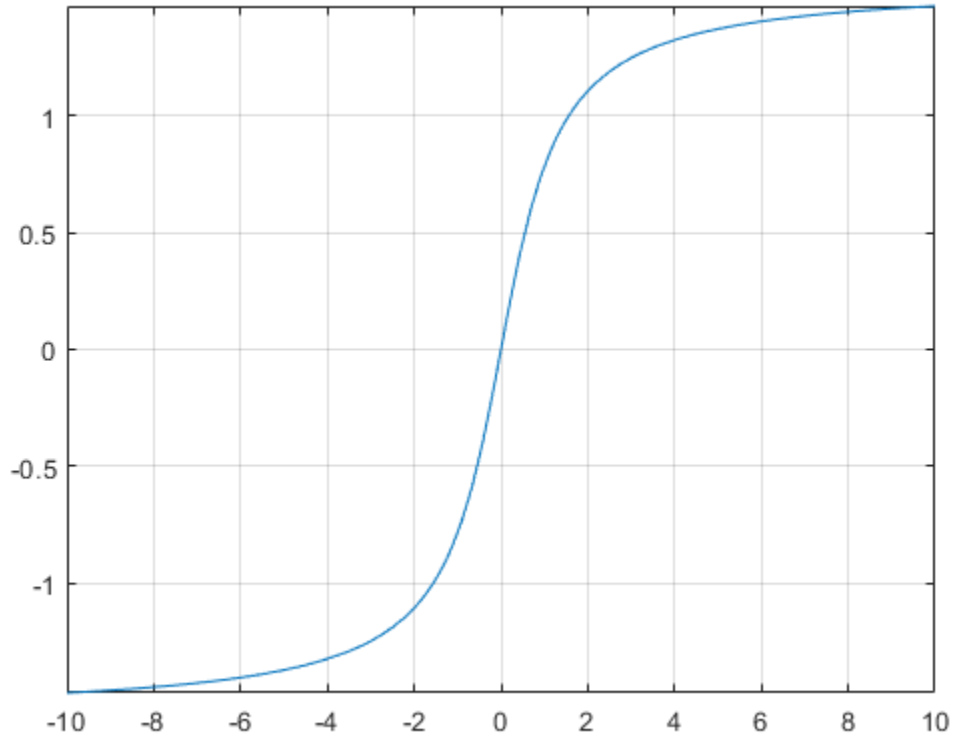

Handle Expressions Containing Inverse Tangent Function

Many functions, such as `diff`, `int`, `taylor`, and `rewrite`, can handle expressions containing `atan`.

Find the first and second derivatives of the inverse tangent function:

```
syms x
diff(atan(x), x)
diff(atan(x), x, x)
```

```
ans =
1/(x^2 + 1)
```

```
ans =
-(2*x)/(x^2 + 1)^2
```

Find the indefinite integral of the inverse tangent function:

```
int(atan(x), x)
```

```
ans =
x*atan(x) - log(x^2 + 1)/2
```

Find the Taylor series expansion of `atan(x)`:

```
taylor(atan(x), x)
```

```
ans =  
x^5/5 - x^3/3 + x
```

Rewrite the inverse tangent function in terms of the natural logarithm:

```
rewrite(atan(x), 'log')
```

```
ans =  
(log(1 - x*1i)*1i)/2 - (log(1 + x*1i)*1i)/2
```

Input Arguments

X — Input

symbolic number | symbolic variable | symbolic expression | symbolic function | symbolic vector | symbolic matrix

Input, specified as a symbolic number, variable, expression, or function, or as a vector or matrix of symbolic numbers, variables, expressions, or functions.

See Also

acos | acot | acsc | asec | asin | atan2 | cos | cot | csc | sec | sin | tan

Introduced before R2006a

atan2

Symbolic four-quadrant inverse tangent

Syntax

`atan2(Y,X)`

Description

`atan2(Y,X)` computes the four-quadrant inverse tangent (arctangent) of Y and X . If Y and X are vectors or matrices, `atan2` computes arctangents element by element.

Examples

Four-Quadrant Inverse Tangent for Numeric and Symbolic Arguments

Compute the arctangents of these parameters. Because these numbers are not symbolic objects, you get floating-point results.

```
[atan2(1, 1), atan2(pi, 4), atan2(Inf, Inf)]
```

```
ans =
    0.7854    0.6658    0.7854
```

Compute the arctangents of these parameters which are converted to symbolic objects:

```
[atan2(sym(1), 1), atan2(sym(pi), sym(4)), atan2(Inf, sym(Inf))]
```

```
ans =
 [ pi/4, atan(pi/4), pi/4]
```

Limit of Four-Quadrant Inverse Tangent

Compute the limits of this symbolic expression:

```
syms x
limit(atan2(x^2/(1 + x), x), x, -Inf)
limit(atan2(x^2/(1 + x), x), x, Inf)
```

```
ans =
 -(3*pi)/4
```

```
ans =
 pi/4
```

Four-Quadrant Inverse Tangent of Array Input

Compute the arctangents of the elements of matrices Y and X :

```
Y = sym([3 sqrt(3); 1 1]);
X = sym([sqrt(3) 3; 1 0]);
atan2(Y, X)
```

```
ans =
 [ pi/3, pi/6]
 [ pi/4, pi/2]
```

Input Arguments

Y — Input

number | vector | matrix | array | symbolic number | symbolic array | symbolic function | symbolic expression

Input, specified as a number, vector, matrix, array, or a symbolic number, array, function, or expression. If Y is a number, it must be real. If Y is a vector or matrix, it must either be a scalar or have the same dimensions as X. All numerical elements of Y must be real.

X — Input

number | vector | matrix | array | symbolic number | symbolic array | symbolic function | symbolic expression

Input, specified as a number, vector, matrix, array, or a symbolic number, array, function, or expression. The function also accepts a vector or matrix of symbolic numbers, variables, expressions, functions. If X is a number, it must be real. If X is a vector or matrix, it must either be a scalar or have the same dimensions as Y. All numerical elements of X must be real.

More About

Four-Quadrant Inverse Tangent

If $X \neq 0$ and $Y \neq 0$, then

$$\text{atan2}(Y, X) = \text{atan}\left(\frac{Y}{X}\right) + \frac{\pi}{2} \text{sign}(Y)(1 - \text{sign}(X))$$

Results returned by `atan2` belong to the closed interval $[-\pi, \pi]$. Results returned by `atan` belong to the closed interval $[-\pi/2, \pi/2]$.

Tips

- Calling `atan2` for numbers (or vectors or matrices of numbers) that are not symbolic objects invokes the MATLAB `atan2` function.
- If one of the arguments X and Y is a vector or a matrix, and another one is a scalar, then `atan2` expands the scalar into a vector or a matrix of the same length with all elements equal to that scalar.
- Symbolic arguments X and Y are assumed to be real.
- If $X = 0$ and $Y > 0$, then `atan2(Y, X)` returns $\pi/2$.

If $X = 0$ and $Y < 0$, then `atan2(Y, X)` returns $-\pi/2$.

If $X = Y = 0$, then `atan2(Y, X)` returns 0 .

Alternatives

For complex $Z = X + Y*i$, the call `atan2(Y, X)` is equivalent to `angle(Z)`.

See Also

angle | atan | conj | imag | real

Introduced in R2013a

atanh

Symbolic inverse hyperbolic tangent function

Syntax

`atanh(X)`

Description

`atanh(X)` returns the inverse hyperbolic tangent function of X .

Examples

Inverse Hyperbolic Tangent Function for Numeric and Symbolic Arguments

Depending on its arguments, `atanh` returns floating-point or exact symbolic results.

Compute the inverse hyperbolic tangent function for these numbers. Because these numbers are not symbolic objects, `atanh` returns floating-point results.

```
A = atanh([-i, 0, 1/6, i/2, i, 2])
```

```
A =
    0.0000 - 0.7854i    0.0000 + 0.0000i    0.1682 + 0.0000i...
    0.0000 + 0.4636i    0.0000 + 0.7854i    0.5493 + 1.5708i
```

Compute the inverse hyperbolic tangent function for the numbers converted to symbolic objects. For many symbolic (exact) numbers, `atanh` returns unresolved symbolic calls.

```
symA = atanh(sym([-i, 0, 1/6, i/2, i, 2]))
```

```
symA =
[ -(pi*1i)/4, 0, atanh(1/6), atanh(1i/2), (pi*1i)/4, atanh(2)]
```

Use `vpa` to approximate symbolic results with floating-point numbers:

```
vpa(symA)
```

```
ans =
[ -0.78539816339744830961566084581988i,...
 0,...
 0.1682361183106064652522967051085,...
 0.46364760900080611621425623146121i,...
 0.78539816339744830961566084581988i,...
 0.54930614433405484569762261846126 - 1.5707963267948966192313216916398i]
```

Plot Inverse Hyperbolic Tangent Function

Plot the inverse hyperbolic tangent function on the interval from -1 to 1.

```
syms x
fplot(atanh(x),[-1 1])
grid on
```

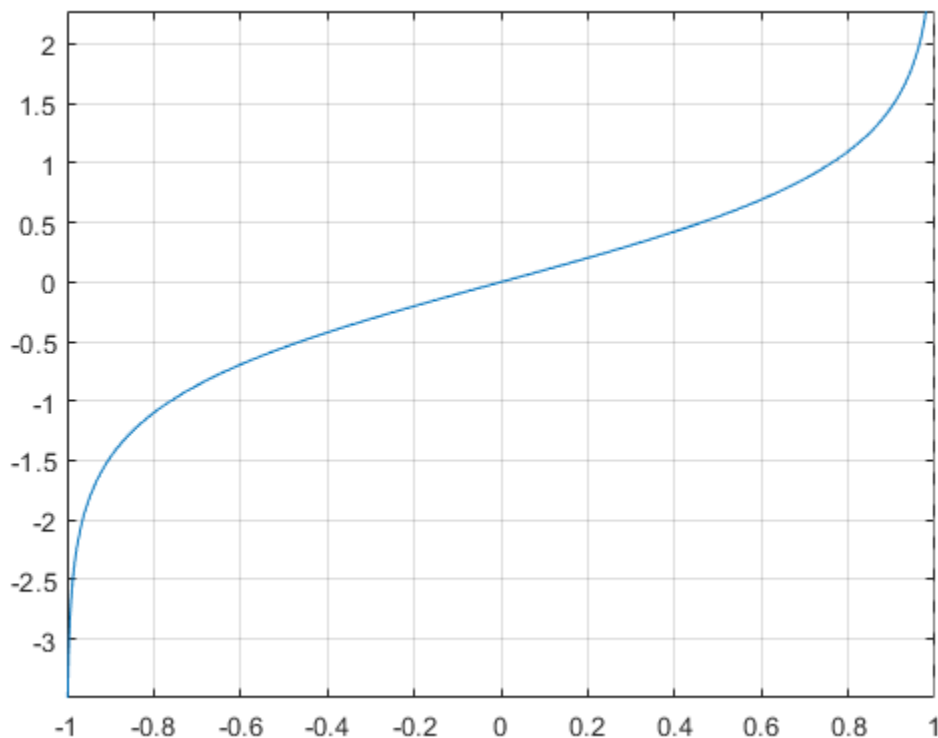

Handle Expressions Containing Inverse Hyperbolic Tangent Function

Many functions, such as `diff`, `int`, `taylor`, and `rewrite`, can handle expressions containing `atanh`.

Find the first and second derivatives of the inverse hyperbolic tangent function:

```
syms x
diff(atanh(x), x)
diff(atanh(x), x, x)
```

```
ans =
-1/(x^2 - 1)
```

```
ans =
(2*x)/(x^2 - 1)^2
```

Find the indefinite integral of the inverse hyperbolic tangent function:

```
int(atanh(x), x)
```

```
ans =
log(x^2 - 1)/2 + x*atanh(x)
```

Find the Taylor series expansion of `atanh(x)`:

```
taylor(atanh(x), x)
```

```
ans =  
x^5/5 + x^3/3 + x
```

Rewrite the inverse hyperbolic tangent function in terms of the natural logarithm:

```
rewrite(atanh(x), 'log')
```

```
ans =  
log(x + 1)/2 - log(1 - x)/2
```

Input Arguments

X — Input

symbolic number | symbolic variable | symbolic expression | symbolic function | symbolic vector | symbolic matrix

Input, specified as a symbolic number, variable, expression, or function, or as a vector or matrix of symbolic numbers, variables, expressions, or functions.

See Also

acosh | acoth | acsch | asech | asinh | cosh | coth | csch | sech | sinh | tanh

Introduced before R2006a

baseUnits

Base units of unit system

Syntax

```
baseUnits(unitSystem)
```

Description

`baseUnits(unitSystem)` returns the base units of the unit system `unitSystem` as a vector of symbolic units. You can use the returned units to create new unit systems by using `newUnitSystem`.

Examples

Base Units of Unit System

Get the base units of a unit system by using `baseUnits`. Then, modify the base units and create a new unit system using the modified base units. Available unit systems include SI, CGS, and US. For all unit systems, see “Unit Systems List” on page 2-36.

Get the base units of the SI unit system.

```
SIUnits = baseUnits('SI')

SIUnits =
 [ [kg], [s], [m], [A], [cd], [mol], [K]]
```

Note Do not define a variable called `baseUnits` because the variable will prevent access to the `baseUnits` function.

Define base units that use kilometer for length and hour for time by modifying `SIUnits` using `subs`.

```
u = symunit;
newUnits = subs(SIUnits,[u.m u.s],[u.km u.hr])

newUnits =
 [ [kg], [h], [km], [A], [cd], [mol], [K]]
```

Define the new unit system by using `newUnitSystem`.

```
newUnitSystem('SI_km_hr',newUnits)

ans =
 "SI_km_hr"
```

To convert units between unit systems, see “Unit Conversions and Unit Systems” on page 2-39.

Input Arguments

unitSystem — Name of unit system

string | character vector

Name of the unit system, specified as a string or character vector.

See Also

`derivedUnits` | `newUnitSystem` | `removeUnitSystem` | `rewrite` | `symunit`

Topics

“Units of Measurement Tutorial” on page 2-19

“Unit Conversions and Unit Systems” on page 2-39

“Units and Unit Systems List” on page 2-25

External Websites

The International System of Units (SI)

Introduced in R2017b

bernoulli

Bernoulli numbers and polynomials

Syntax

```
bernoulli(n)
bernoulli(n,x)
```

Description

`bernoulli(n)` returns the n th Bernoulli number on page 4-100.

`bernoulli(n,x)` returns the n th Bernoulli polynomial on page 4-100.

Examples

Bernoulli Numbers with Odd and Even Indices

The 0th Bernoulli number is 1. The next Bernoulli number can be $-1/2$ or $1/2$, depending on the definition. The `bernoulli` function uses $-1/2$. The Bernoulli numbers with even indices $n > 1$ alternate the signs. Any Bernoulli number with an odd index $n > 2$ is 0.

Compute the even-indexed Bernoulli numbers with the indices from 0 to 10. Because these indices are not symbolic objects, `bernoulli` returns floating-point results.

```
bernoulli(0:2:10)

ans =
    1.0000    0.1667   -0.0333    0.0238   -0.0333    0.0758
```

Compute the same Bernoulli numbers for the indices converted to symbolic objects:

```
bernoulli(sym(0:2:10))

ans =
[ 1, 1/6, -1/30, 1/42, -1/30, 5/66]
```

Compute the odd-indexed Bernoulli numbers with the indices from 1 to 11:

```
bernoulli(sym(1:2:11))

ans =
[ -1/2, 0, 0, 0, 0, 0]
```

Bernoulli Polynomials

For the Bernoulli polynomials, use `bernoulli` with two input arguments.

Compute the first, second, and third Bernoulli polynomials in variables x , y , and z , respectively:

```
syms x y z
bernoulli(1, x)
```

```
bernoulli(2, y)
bernoulli(3, z)
```

```
ans =
x - 1/2
```

```
ans =
y^2 - y + 1/6
```

```
ans =
z^3 - (3*z^2)/2 + z/2
```

If the second argument is a number, `bernoulli` evaluates the polynomial at that number. Here, the result is a floating-point number because the input arguments are not symbolic numbers:

```
bernoulli(2, 1/3)
```

```
ans =
-0.0556
```

To get the exact symbolic result, convert at least one of the numbers to a symbolic object:

```
bernoulli(2, sym(1/3))
```

```
ans =
-1/18
```

Plot Bernoulli Polynomials

Plot the first six Bernoulli polynomials.

```
syms x
fplot(bernoulli(0:5, x), [-0.8 1.8])
title('Bernoulli Polynomials')
grid on
```

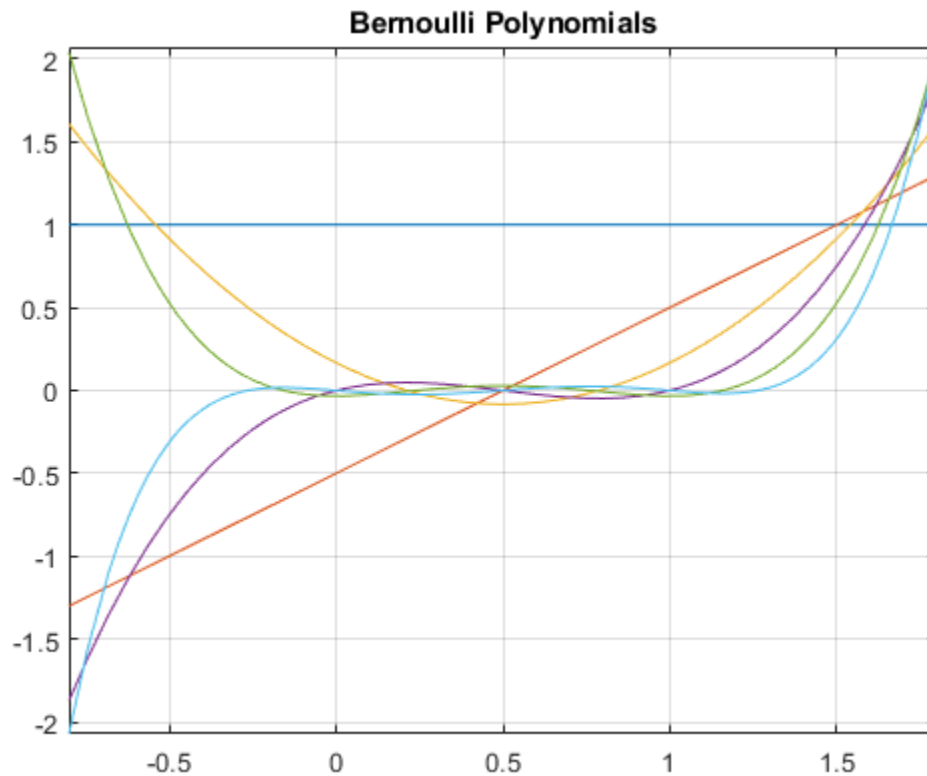
Handle Expressions Containing Bernoulli Polynomials

Many functions, such as `diff` and `expand`, handles expressions containing `bernoulli`.

Find the first and second derivatives of the Bernoulli polynomial:

```
syms n x
diff(bernoulli(n,x^2), x)
```

```
ans =
2*n*x*bernoulli(n - 1, x^2)
```

```
diff(bernoulli(n,x^2), x, x)
```

```
ans =
2*n*bernoulli(n - 1, x^2) +...
4*n*x^2*bernoulli(n - 2, x^2)*(n - 1)
```

Expand these expressions containing the Bernoulli polynomials:

```
expand(bernoulli(n, x + 3))
```

```
ans =
bernoulli(n, x) + (n*(x + 1)^n)/(x + 1) +...
(n*(x + 2)^n)/(x + 2) + (n*x^n)/x
```

```
expand(bernoulli(n, 3*x))
```

```
ans =
(3^n*bernoulli(n, x))/3 + (3^n*bernoulli(n, x + 1/3))/3 +...
(3^n*bernoulli(n, x + 2/3))/3
```

Input Arguments

n — Index of the Bernoulli number or polynomial

nonnegative integer | symbolic nonnegative integer | symbolic variable | symbolic expression | symbolic function | symbolic vector | symbolic matrix

Index of the Bernoulli number or polynomial, specified as a nonnegative integer, symbolic nonnegative integer, variable, expression, function, vector, or matrix. If n is a vector or matrix, `bernoulli` returns Bernoulli numbers or polynomials for each element of n . If one input argument is a scalar and the other one is a vector or a matrix, `bernoulli(n,x)` expands the scalar into a vector or matrix of the same size as the other argument with all elements equal to that scalar.

x — Polynomial variable

symbolic variable | symbolic expression | symbolic function | symbolic vector | symbolic matrix

Polynomial variable, specified as a symbolic variable, expression, function, vector, or matrix. If x is a vector or matrix, `bernoulli` returns Bernoulli numbers or polynomials for each element of x . When you use the `bernoulli` function to find Bernoulli polynomials, at least one argument must be a scalar or both arguments must be vectors or matrices of the same size. If one input argument is a scalar and the other one is a vector or a matrix, `bernoulli(n,x)` expands the scalar into a vector or matrix of the same size as the other argument with all elements equal to that scalar.

More About

Bernoulli Polynomials

The Bernoulli polynomials are defined as follows:

$$\frac{te^{xt}}{e^t - 1} = \sum_{n=0}^{\infty} \text{bernoulli}(n, x) \frac{t^n}{n!}$$

Bernoulli Numbers

The Bernoulli numbers are defined as follows:

$$\text{bernoulli}(n) = \text{bernoulli}(n, 0)$$

See Also

`euler`

Introduced in R2014a

bernstein

Bernstein polynomials

Syntax

```
bernstein(f,n,t)
bernstein(g,n,t)
bernstein(g,var,n,t)
```

Description

`bernstein(f,n,t)` with a function handle `f` returns the n th-order Bernstein polynomial on page 4-105 $\text{symsum}(n\text{choose}(n,k)*t^k*(1-t)^{(n-k)}*f(k/n),k,0,n)$, evaluated at the point `t`. This polynomial approximates the function `f` over the interval $[0, 1]$.

`bernstein(g,n,t)` with a symbolic expression or function `g` returns the n th-order Bernstein polynomial, evaluated at the point `t`. This syntax regards `g` as a univariate function of the variable determined by `symvar(g,1)`.

If any argument is symbolic, `bernstein` converts all arguments except a function handle to symbolic, and converts a function handle's results to symbolic.

`bernstein(g,var,n,t)` with a symbolic expression or function `g` returns the approximating n th-order Bernstein polynomial, regarding `g` as a univariate function of the variable `var`.

Examples

Approximation of Sine Function Specified as Function Handle

Approximate the sine function by the 10th- and 100th-degree Bernstein polynomials:

```
syms t
b10 = bernstein(@(t) sin(2*pi*t), 10, t);
b100 = bernstein(@(t) sin(2*pi*t), 100, t);
```

Plot `sin(2*pi*t)` and its approximations:

```
fplot(sin(2*pi*t), [0,1])
hold on
fplot(b10, [0,1])
fplot(b100, [0,1])

legend('sine function', '10th-degree polynomial', ...
       '100th-degree polynomial')
title('Bernstein polynomials')
hold off
```

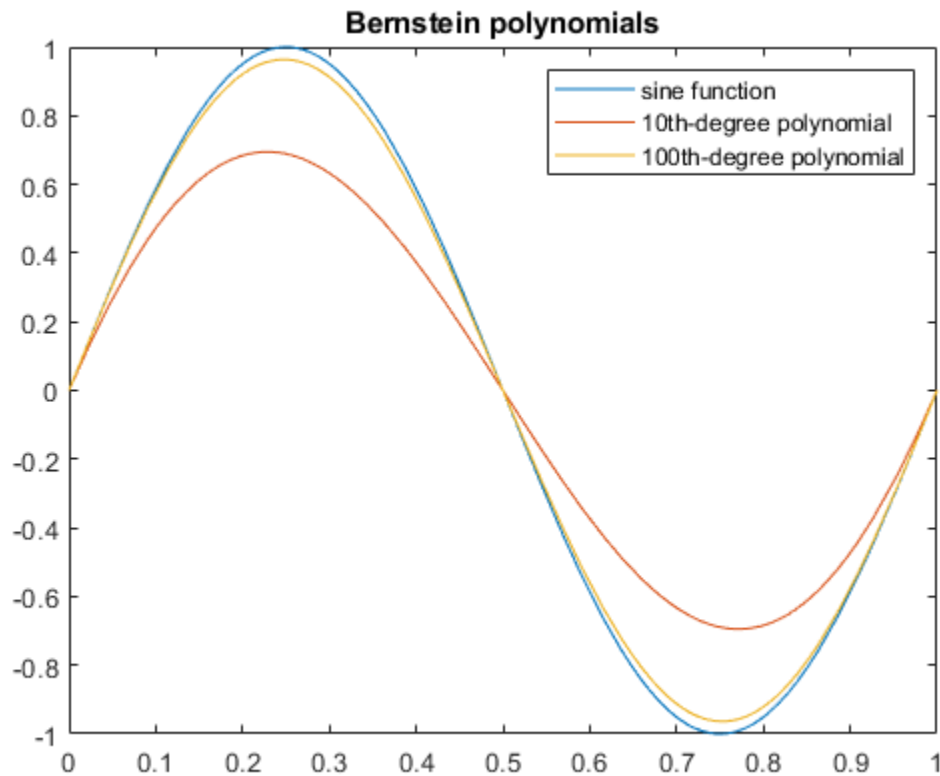

Approximation of Exponential Function Specified as Symbolic Expression

Approximate the exponential function by the second-order Bernstein polynomial in the variable t :

```
syms x t
bernstein(exp(x), 2, t)

ans =
(t - 1)^2 + t^2*exp(1) - 2*t*exp(1/2)*(t - 1)
```

Approximate the multivariate exponential function. When you approximate a multivariate function, `bernstein` regards it as a univariate function of the default variable determined by `symvar`. The default variable for the expression $y*\exp(x*y)$ is x :

```
syms x y t
symvar(y*exp(x*y), 1)

ans =
x
```

`bernstein` treats this expression as a univariate function of x :

```
bernstein(y*exp(x*y), 2, t)

ans =
y*(t - 1)^2 + t^2*y*exp(y) - 2*t*y*exp(y/2)*(t - 1)
```

To treat $y*\exp(x*y)$ as a function of the variable y , specify the variable explicitly:

```
bernstein(y*exp(x*y), y, 2, t)
```

```
ans =
t^2*exp(x) - t*exp(x/2)*(t - 1)
```

Approximation of Linear Ramp Specified as Symbolic Function

Approximate function f representing a linear ramp by the fifth-order Bernstein polynomials in the variable t :

```
syms f(t)
f(t) = triangularPulse(1/4, 3/4, Inf, t);
p = bernstein(f, 5, t)

p =
7*t^3*(t - 1)^2 - 3*t^2*(t - 1)^3 - 5*t^4*(t - 1) + t^5
```

Simplify the result:

```
simplify(p)

ans =
-t^2*(2*t - 3)
```

Numerical Stability of Simplified Bernstein Polynomials

When you simplify a high-order symbolic Bernstein polynomial, the result often cannot be evaluated in a numerically stable way.

Approximate this rectangular pulse function by the 100th-degree Bernstein polynomial, and then simplify the result:

```
f = @(x)rectangularPulse(1/4,3/4,x);
b1 = bernstein(f, 100, sym('t'));
b2 = simplify(b1);
```

Convert the polynomial $b1$ and the simplified polynomial $b2$ to MATLAB functions:

```
f1 = matlabFunction(b1);
f2 = matlabFunction(b2);
```

Compare the plot of the original rectangular pulse function, its numerically stable Bernstein representation $f1$, and its simplified version $f2$. The simplified version is not numerically stable.

```
t = 0:0.001:1;
plot(t, f(t), t, f1(t), t, f2(t))
hold on
legend('original function','Bernstein polynomial',...
       'simplified Bernstein polynomial')
hold off
```

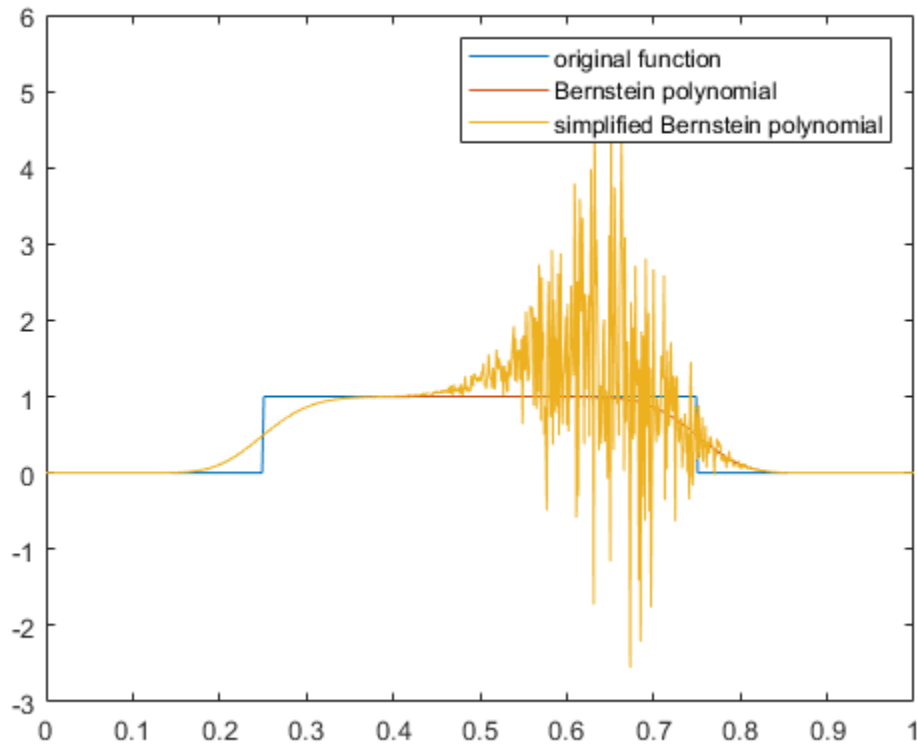

Input Arguments

f – Function to be approximated by a polynomial

function handle

Function to be approximated by a polynomial, specified as a function handle. `f` must accept one scalar input argument and return a scalar value.

g – Function to be approximated by a polynomial

symbolic expression | symbolic function

Function to be approximated by a polynomial, specified as a symbolic expression or function.

n – Bernstein polynomial order

nonnegative integer

Bernstein polynomial order, specified as a nonnegative number.

t – Evaluation point

number | symbolic number | symbolic variable | symbolic expression | symbolic function

Evaluation point, specified as a number, symbolic number, variable, expression, or function. If `t` is a symbolic function, the evaluation point is the mathematical expression that defines `t`. To extract the mathematical expression defining `t`, `bernstein` uses `formula(t)`.

var – Free variable

symbolic variable

Free variable, specified as a symbolic variable.

More About**Bernstein Polynomials**

A Bernstein polynomial is a linear combination of Bernstein basis polynomials.

A Bernstein polynomial of degree n is defined as follows:

$$B(t) = \sum_{k=0}^n \beta_k b_{k,n}(t).$$

Here,

$$b_{k,n}(t) = \binom{n}{k} t^k (1-t)^{n-k}, \quad k = 0, \dots, n$$

are the Bernstein basis polynomials, and $\binom{n}{k}$ is a binomial coefficient.

The coefficients β_k are called Bernstein coefficients or Bezier coefficients.

If f is a continuous function on the interval $[0, 1]$ and

$$B_n(f)(t) = \sum_{k=0}^n f\left(\frac{k}{n}\right) b_{k,n}(t)$$

is the approximating Bernstein polynomial, then

$$\lim_{n \rightarrow \infty} B_n(f)(t) = f(t)$$

uniformly in t on the interval $[0, 1]$.

Tips

- Symbolic polynomials returned for symbolic t are numerically stable when substituting numerical values between 0 and 1 for t .
- If you simplify a symbolic Bernstein polynomial, the result can be unstable when substituting numerical values for the curve parameter t .

See Also

bernsteinMatrix | formula | nchoosek | symsum | symvar

Introduced in R2013b

bernsteinMatrix

Bernstein matrix

Syntax

```
B = bernsteinMatrix(n,t)
```

Description

`B = bernsteinMatrix(n,t)`, where `t` is a vector, returns the `length(t)`-by-`(n+1)` Bernstein matrix `B`, such that $B(i,k+1) = \binom{n}{k} t(i)^k (1-t(i))^{n-k}$. Here, the index `i` runs from 1 to `length(t)`, and the index `k` runs from 0 to `n`.

The Bernstein matrix is also called the Bezier matrix.

Use Bernstein matrices to construct Bezier curves:

```
bezierCurve = bernsteinMatrix(n, t)*P
```

Here, the `n+1` rows of the matrix `P` specify the control points of the Bezier curve. For example, to construct the second-order 3-D Bezier curve, specify the control points as:

```
P = [p0x, p0y, p0z; p1x, p1y, p1z; p2x, p2y, p2z]
```

Examples

2-D Bezier Curve

Plot the fourth-order Bezier curve specified by the control points `p0 = [0 1]`, `p1 = [4 3]`, `p2 = [6 2]`, `p3 = [3 0]`, `p4 = [2 4]`. Create a matrix with each row representing a control point:

```
P = [0 1; 4 3; 6 2; 3 0; 2 4];
```

Compute the fourth-order Bernstein matrix `B`:

```
syms t
B = bernsteinMatrix(4, t)
B =
[ (t - 1)^4, -4*t*(t - 1)^3, 6*t^2*(t - 1)^2, -4*t^3*(t - 1), t^4]
```

Construct the Bezier curve:

```
bezierCurve = simplify(B*P)
bezierCurve =
[ -2*t*(- 5*t^3 + 6*t^2 + 6*t - 8), 5*t^4 + 8*t^3 - 18*t^2 + 8*t + 1]
```

Plot the curve adding the control points to the plot:

```
fplot(bezierCurve(1), bezierCurve(2), [0, 1])
hold on
scatter(P(:,1), P(:,2), 'filled')
```



```
title('Fourth-order Bezier curve')
hold off
```

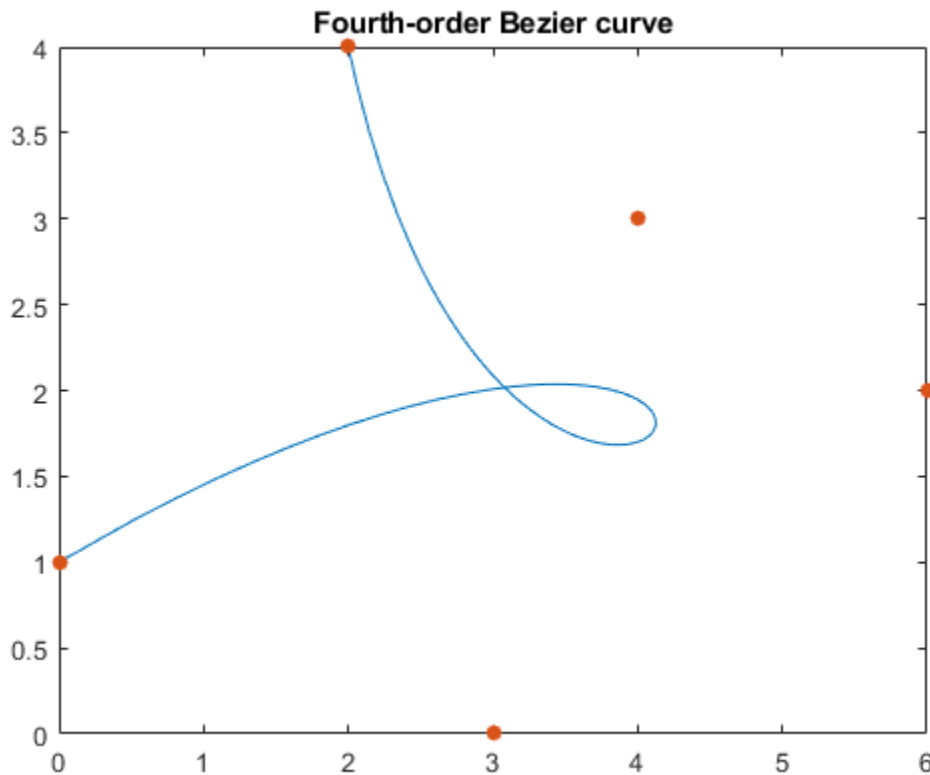

3-D Bezier Curve

Construct the third-order Bezier curve specified by the 4-by-3 matrix P of control points. Each control point corresponds to a row of the matrix P .

```
P = [0 0 0; 2 2 2; 2 -1 1; 6 1 3];
```

Compute the third-order Bernstein matrix:

```
syms t
B = bernsteinMatrix(3,t)

B =
[ -(t - 1)^3, 3*t*(t - 1)^2, -3*t^2*(t - 1), t^3]
```

Construct the Bezier curve:

```
bezierCurve = simplify(B*P)

bezierCurve =
[ 6*t*(t^2 - t + 1), t*(10*t^2 - 15*t + 6), 3*t*(2*t^2 - 3*t + 2)]
```

Plot the curve adding the control points to the plot:

```
fplot3(bezierCurve(1), bezierCurve(2), bezierCurve(3), [0, 1])
hold on
```

```
scatter3(P(:,1), P(:,2), P(:,3), 'filled')
hold off
```

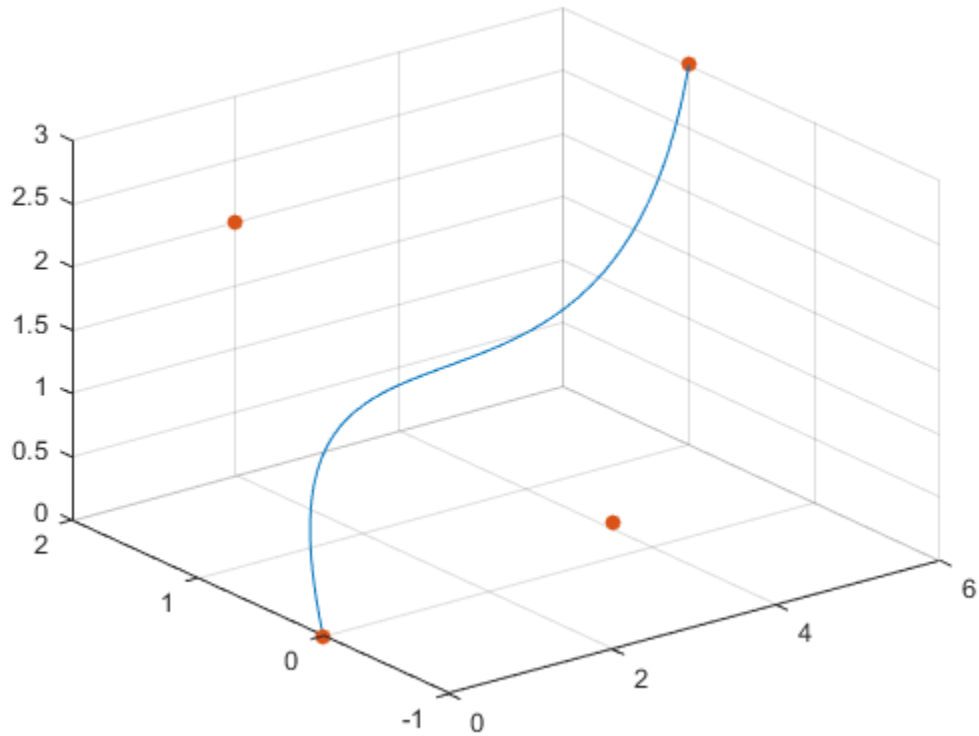

3-D Bezier Curve with Evaluation Point Specified as Vector

Construct the third-order Bezier curve with the evaluation point specified by the following 1-by-101 vector t :

```
t = 0:1/100:1;
```

Compute the third-order 101-by-4 Bernstein matrix and specify the control points:

```
B = bernsteinMatrix(3,t);
P = [0 0 0; 2 2 2; 2 -1 1; 6 1 3];
```

Construct and plot the Bezier curve. Add grid lines and control points to the plot.

```
bezierCurve = B*P;
plot3(bezierCurve(:,1), bezierCurve(:,2), bezierCurve(:,3))
hold on
grid
scatter3(P(:,1), P(:,2), P(:,3), 'filled')
hold off
```

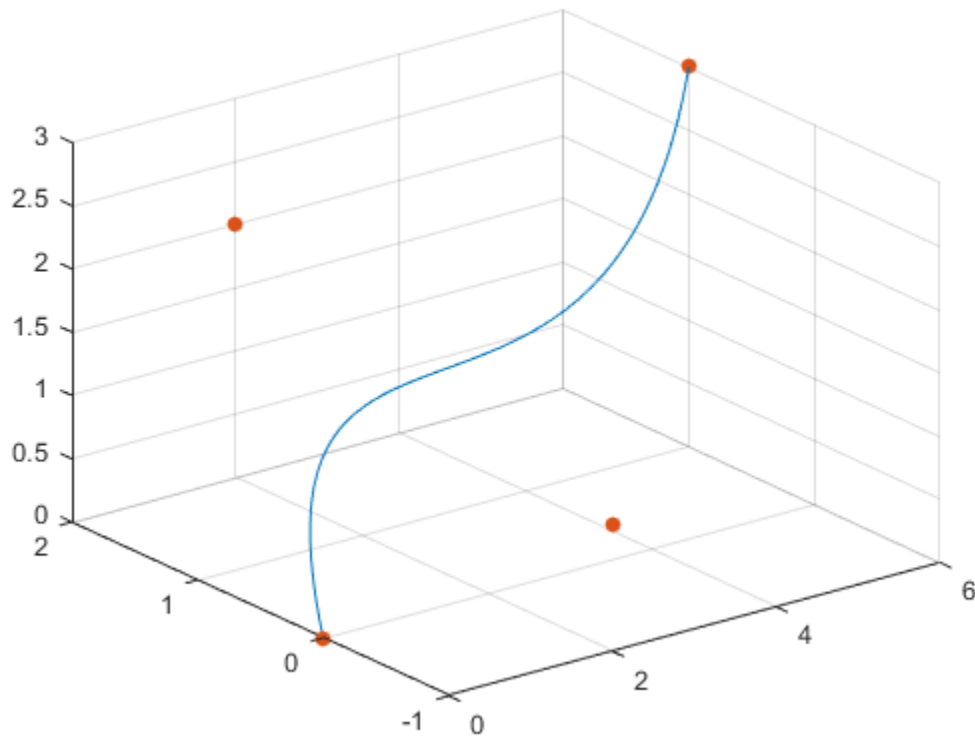

Input Arguments

n – Approximation order

nonnegative integer

Approximation order, specified as a nonnegative integer.

t – Evaluation point

number | vector | symbolic number | symbolic variable | symbolic expression | symbolic vector

Evaluation point, specified as a number, symbolic number, variable, expression, or vector.

Output Arguments

B – Bernstein matrix

matrix

Bernstein matrix, returned as a $\text{length}(t)$ -by- $n+1$ matrix.

See Also

bernstein | nchoosek | symsum | symvar

Introduced in R2013b

besselh

Bessel function of third kind (Hankel function) for symbolic expressions

Syntax

```
H = besselh(nu,K,z)
H = besselh(nu,z)
H = besselh(nu,K,z,1)
```

Description

`H = besselh(nu,K,z)` computes the Hankel function $H_\nu^{(K)}(z)$, where $K = 1$ or 2 , for each element of the complex array z . The output H has the symbolic data type if any input argument is symbolic. See “Bessel’s Equation” on page 4-112.

`H = besselh(nu,z)` uses $K = 1$.

`H = besselh(nu,K,z,1)` scales $H_\nu^{(K)}(z)$ by $\exp(-i*z)$ if $K = 1$, and by $\exp(+i*z)$ if $K = 2$.

Examples

Compute Hankel Function

Specify the Hankel function for a symbolic variable.

```
syms z
H = besselh(3/2,1,z)
```

```
H =

$$-\frac{\sqrt{2} e^{zi} \left(1 + \frac{i}{z}\right)}{\sqrt{z} \sqrt{\pi}}$$

```

Evaluate the function symbolically and numerically at the point $z = 1 + 2i$.

```
Hval = subs(H,z,1+2i)
```

```
Hval =

$$\frac{\sqrt{2} e^{-2+i} \left(-\frac{7}{5} - \frac{1}{5} i\right)}{\sqrt{1+2i} \sqrt{\pi}}$$

```

```
vpa(Hval)
```

```
ans = -0.084953341280586443678471523210602 - 0.056674847869835575940327724800155 i
```

Specify the function without the second argument, $K = 1$.

```
H2 = besselh(3/2,z)
```

```
H2 =
```

$$-\frac{\sqrt{2} e^{zi} \left(1 + \frac{i}{z}\right)}{\sqrt{z} \sqrt{\pi}}$$

Notice that the functions H and H2 are identical.

Scale the function by e^{-iz} by using the four-argument syntax.

Hnew = besselh(3/2,1,z,1)

Hnew =

$$-\frac{\sqrt{2} \left(1 + \frac{i}{z}\right)}{\sqrt{z} \sqrt{\pi}}$$

Find the derivative of H.

diffH = diff(H)

diffH =

$$\frac{\sqrt{2} e^{zi} i}{z^{5/2} \sqrt{\pi}} - \frac{\sqrt{2} e^{zi} \left(1 + \frac{i}{z}\right) i}{\sqrt{z} \sqrt{\pi}} + \frac{\sqrt{2} e^{zi} \left(1 + \frac{i}{z}\right)}{2 z^{3/2} \sqrt{\pi}}$$

Input Arguments

nu — Hankel function order

symbolic array | double array

Hankel function order, specified as a symbolic array or double array. If nu and z are arrays of the same size, the result is also that size. If either input is a scalar, besselh expands it to the other input size.

Example: nu = 3*sym(pi)/2

K — Kind of Hankel function

symbolic 1 or 2 | double 1 or 2

Kind of Hankel function, specified as a symbolic or double 1 or 2. K identifies the sign of the added Bessel function Y:

$$H_v^{(1)}(z) = J_v(z) + iY_v(z)$$

$$H_v^{(2)}(z) = J_v(z) - iY_v(z).$$

Example: K = sym(2)

z — Hankel function argument

symbolic array | double array

Hankel function argument, specified as a symbolic array or double array. If nu and z are arrays of the same size, the result is also that size. If either input is a scalar, besselh expands it to the other input size.

Example: z = sym(1+1i)

More About

Bessel's Equation

The differential equation

$$z^2 \frac{d^2 w}{dz^2} + z \frac{dw}{dz} + (z^2 - \nu^2)w = 0,$$

where ν is a real constant, is called *Bessel's equation*, and its solutions are known as *Bessel functions*.

$J_\nu(z)$ and $J_{-\nu}(z)$ form a fundamental set of solutions of Bessel's equation for noninteger ν . $Y_\nu(z)$ is a second solution of Bessel's equation—linearly independent of $J_\nu(z)$ —defined by

$$Y_\nu(z) = \frac{J_\nu(z)\cos(\nu\pi) - J_{-\nu}(z)}{\sin(\nu\pi)}.$$

The relationship between the Hankel and Bessel functions is

$$H_\nu^{(1)}(z) = J_\nu(z) + iY_\nu(z)$$

$$H_\nu^{(2)}(z) = J_\nu(z) - iY_\nu(z).$$

Here, $J_\nu(z)$ is `besselj`, and $Y_\nu(z)$ is `bessely`.

References

- [1] Abramowitz, M., and I. A. Stegun. *Handbook of Mathematical Functions*. National Bureau of Standards, Applied Math. Series #55, Dover Publications, 1965.

See Also

`besseli` | `besselj` | `besselk` | `bessely`

Introduced in R2018b

besseli

Modified Bessel function of the first kind for symbolic expressions

Syntax

```
besseli(nu, z)
```

Description

`besseli(nu, z)` returns the modified Bessel function of the first kind on page 4-116, $I_\nu(z)$.

Examples

Find Modified Bessel Function of First Kind

Compute the modified Bessel functions of the first kind for these numbers. Because these numbers are not symbolic objects, you get floating-point results.

```
[besseli(0, 5), besseli(-1, 2), besseli(1/3, 7/4), besseli(1, 3/2 + 2*i)]
```

```
ans =
 27.2399 + 0.0000i  1.5906 + 0.0000i  1.7951 + 0.0000i  -0.1523 + 1.0992i
```

Compute the modified Bessel functions of the first kind for the numbers converted to symbolic objects. For most symbolic (exact) numbers, `besseli` returns unresolved symbolic calls.

```
[besseli(sym(0), 5), besseli(sym(-1), 2), ...
  besseli(1/3, sym(7/4)), besseli(sym(1), 3/2 + 2*i)]
```

```
ans =
 [ besseli(0, 5), besseli(1, 2), besseli(1/3, 7/4), besseli(1, 3/2 + 2i)]
```

For symbolic variables and expressions, `besseli` also returns unresolved symbolic calls:

```
syms x y
[besseli(x, y), besseli(1, x^2), besseli(2, x - y), besseli(x^2, x*y)]
```

```
ans =
 [ besseli(x, y), besseli(1, x^2), besseli(2, x - y), besseli(x^2, x*y)]
```

Solve Bessel Differential Equation for Modified Bessel Functions

Solve this second-order differential equation. The solutions are the modified Bessel functions of the first and the second kind.

```
syms nu w(z)
dsolve(z^2*diff(w, 2) + z*diff(w) -(z^2 + nu^2)*w == 0)
```

```
ans =
 C2*besseli(nu, z) + C3*besselk(nu, z)
```

Verify that the modified Bessel function of the first kind is a valid solution of the modified Bessel differential equation.

```

syms nu z
isAlways(z^2*diff(besseli(nu, z), z, 2) + z*diff(besseli(nu, z), z)...
- (z^2 + nu^2)*besseli(nu, z) == 0)

ans =
    logical
     1

```

Special Values of Modified Bessel Function of First Kind

If the first parameter is an odd integer multiplied by 1/2, `besseli` rewrites the Bessel functions in terms of elementary functions:

```

syms x
besseli(1/2, x)

ans =
(2^(1/2)*sinh(x))/(x^(1/2)*pi^(1/2))

besseli(-1/2, x)

ans =
(2^(1/2)*cosh(x))/(x^(1/2)*pi^(1/2))

besseli(-3/2, x)

ans =
(2^(1/2)*(sinh(x) - cosh(x)/x))/(x^(1/2)*pi^(1/2))

besseli(5/2, x)

ans =
-(2^(1/2)*((3*cosh(x))/x - sinh(x)*(3/x^2 + 1)))/(x^(1/2)*pi^(1/2))

```

Differentiate Modified Bessel Function of First Kind

Differentiate the expressions involving the modified Bessel functions of the first kind:

```

syms x y
diff(besseli(1, x))
diff(diff(besseli(0, x^2 + x*y - y^2), x), y)

ans =
besseli(0, x) - besseli(1, x)/x

ans =
besseli(1, x^2 + x*y - y^2) +...
(2*x + y)*(besseli(0, x^2 + x*y - y^2)*(x - 2*y) - ...
(besseli(1, x^2 + x*y - y^2)*(x - 2*y)))/(x^2 + x*y - y^2)

```

Bessel Function for Matrix Input

Call `besseli` for the matrix `A` and the value 1/2. The result is a matrix of the modified Bessel functions `besseli(1/2, A(i,j))`.

```

syms x
A = [-1, pi; x, 0];
besseli(1/2, A)

```



```
ans =
 [ (2^(1/2)*sinh(1)*I_1)/pi^(1/2), (2^(1/2)*sinh(pi))/pi]
 [ (2^(1/2)*sinh(x))/(x^(1/2)*pi^(1/2)), 0]
```

Plot the Modified Bessel Functions of the First Kind

Plot the modified Bessel functions of the first kind for $\nu = 0, 1, 2, 3$.

```
syms x y
fplot(besseli(0:3, x))
axis([0 4 -0.1 4])
grid on

ylabel('I_\nu(x)')
legend('I_0', 'I_1', 'I_2', 'I_3', 'Location', 'Best')
title('Modified Bessel functions of the first kind')
```

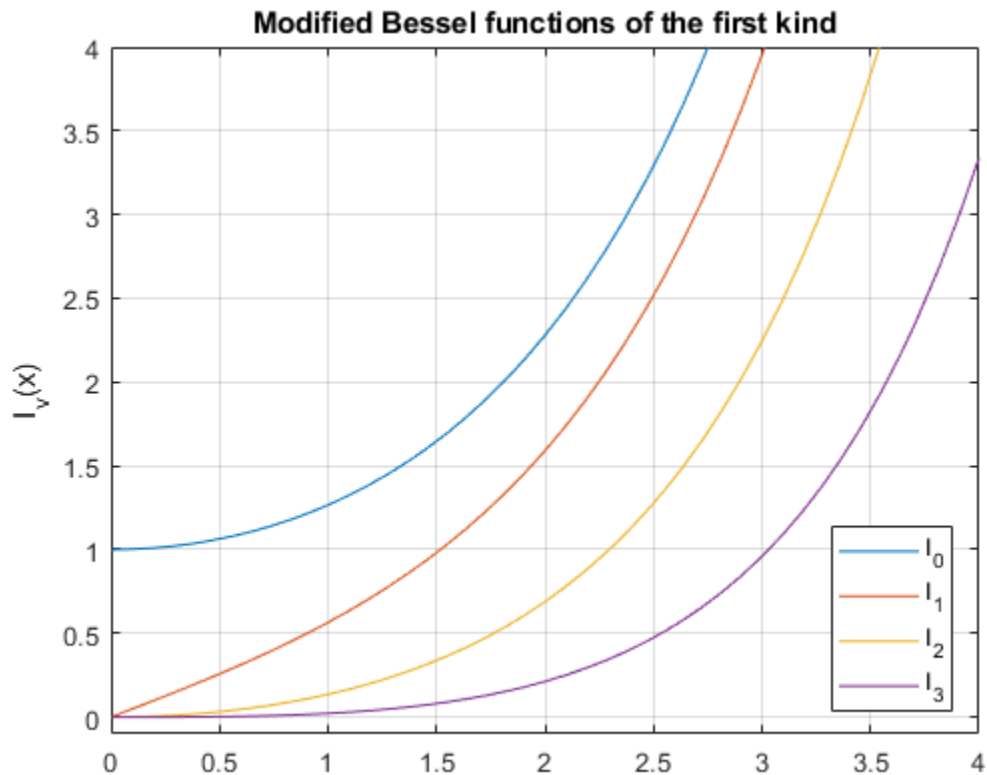

Input Arguments

nu – Input

number | vector | matrix | multidimensional array | symbolic number | symbolic array | symbolic function | symbolic expression

Input, specified as a number, vector, matrix, array, or a symbolic number, variable, expression, function, or array. If nu is a vector or matrix, besseli returns the modified Bessel function of the first kind for each element of nu.

z – Input

number | vector | matrix | multidimensional array | symbolic number | symbolic array | symbolic function | symbolic expression

Input, specified as a number, vector, matrix, array, or a symbolic number, variable, expression, function, or array. If `nu` is a vector or matrix, `besseli` returns the modified Bessel function of the first kind for each element of `nu`.

More About**Modified Bessel Functions of the First Kind**

The modified Bessel differential equation

$$z^2 \frac{d^2 w}{dz^2} + z \frac{dw}{dz} - (z^2 + \nu^2)w = 0$$

has two linearly independent solutions. These solutions are represented by the modified Bessel functions of the first kind, $I_\nu(z)$, and the modified Bessel functions of the second kind, $K_\nu(z)$:

$$w(z) = C_1 I_\nu(z) + C_2 K_\nu(z)$$

This formula is the integral representation of the modified Bessel functions of the first kind:

$$I_\nu(z) = \frac{(z/2)^\nu}{\sqrt{\pi} \Gamma(\nu + 1/2)} \int_0^\pi e^{z \cos(t)} \sin(t)^{2\nu} dt$$

Tips

- Calling `besseli` for a number that is not a symbolic object invokes the MATLAB `besseli` function.
- At least one input argument must be a scalar or both arguments must be vectors or matrices of the same size. If one input argument is a scalar and the other one is a vector or a matrix, `besseli(nu, z)` expands the scalar into a vector or matrix of the same size as the other argument with all elements equal to that scalar.

References

- [1] Olver, F. W. J. "Bessel Functions of Integer Order." *Handbook of Mathematical Functions with Formulas, Graphs, and Mathematical Tables*. (M. Abramowitz and I. A. Stegun, eds.). New York: Dover, 1972.
- [2] Antosiewicz, H. A. "Bessel Functions of Fractional Order." *Handbook of Mathematical Functions with Formulas, Graphs, and Mathematical Tables*. (M. Abramowitz and I. A. Stegun, eds.). New York: Dover, 1972.

See Also

`airy` | `besselh` | `besselj` | `besselk` | `bessely`

Introduced in R2014a

besselj

Bessel function of the first kind for symbolic expressions

Syntax

```
besselj(nu, z)
```

Description

`besselj(nu, z)` returns the Bessel function of the first kind on page 4-121, $J_\nu(z)$.

Examples

Find Bessel Function of First Kind

Compute the Bessel functions of the first kind for these numbers. Because these numbers are floating point, you get floating-point results.

```
[besselj(0,5) besselj(-1,2) besselj(1/3,7/4) besselj(1,3/2+2*i)]
```

```
ans =
-0.1776 + 0.0000i -0.5767 + 0.0000i 0.5496 + 0.0000i 1.6113 + 0.3982i
```

Compute the Bessel functions of the first kind for the numbers converted to symbolic form. For most symbolic (exact) numbers, `besselj` returns unresolved symbolic calls.

```
[besselj(sym(0),5) besselj(sym(-1),2)...
 besselj(1/3,sym(7/4)) besselj(sym(1),3/2+2*i)]
```

```
ans =
[ besselj(0, 5), -besselj(1, 2), besselj(1/3, 7/4), besselj(1, 3/2 + 2i)]
```

For symbolic variables and expressions, `besselj` also returns unresolved symbolic calls.

```
syms x y
[besselj(x,y) besselj(1,x^2) besselj(2,x-y) besselj(x^2,x*y)]
```

```
ans =
[ besselj(x, y), besselj(1, x^2), besselj(2, x - y), besselj(x^2, x*y)]
```

Solve Bessel Differential Equation for Bessel Functions

Solve this second-order differential equation. The solutions are the Bessel functions of the first and the second kind.

```
syms nu w(z)
ode = z^2*diff(w,2) + z*diff(w) +(z^2-nu^2)*w == 0;
dsolve(ode)
```

```
ans =
C2*besselj(nu, z) + C3*bessely(nu, z)
```

Verify that the Bessel function of the first kind is a valid solution of the Bessel differential equation.

```
cond = subs(ode,w,besselj(nu,z));
isAlways(cond)
```

```
ans =
  logical
  1
```

Special Values of Bessel Function of First Kind

Show that if the first parameter is an odd integer multiplied by 1/2, `besselj` rewrites the Bessel functions in terms of elementary functions.

```
syms x
besselj(1/2,x)
```

```
ans =
(2^(1/2)*sin(x))/(x^(1/2)*pi^(1/2))
```

```
besselj(-1/2,x)
```

```
ans =
(2^(1/2)*cos(x))/(x^(1/2)*pi^(1/2))
```

```
besselj(-3/2,x)
```

```
ans =
-(2^(1/2)*(sin(x) + cos(x)/x))/(x^(1/2)*pi^(1/2))
```

```
besselj(5/2,x)
```

```
ans =
-(2^(1/2)*((3*cos(x))/x - sin(x)*(3/x^2 - 1)))/(x^(1/2)*pi^(1/2))
```

Differentiate Bessel Function of First Kind

Differentiate expressions involving the Bessel functions of the first kind.

```
syms x y
diff(besselj(1,x))
```

```
ans =
besselj(0, x) - besselj(1, x)/x
```

```
diff(diff(besselj(0,x^2+x*y-y^2), x), y)
```

```
ans =
- besselj(1, x^2 + x*y - y^2) - ...
(2*x + y)*(besselj(0, x^2 + x*y - y^2)*(x - 2*y) - ...
(besselj(1, x^2 + x*y - y^2)*(x - 2*y)))/(x^2 + x*y - y^2)
```

Find Bessel Function for Matrix Input

Call `besselj` for the matrix `A` and the value 1/2. `besselj` acts element-wise to return matrix of Bessel functions.

```
syms x
A = [-1, pi; x, 0];
besselj(1/2, A)
```

```
ans =
 [ (2^(1/2)*sin(1)*1i)/pi^(1/2), 0]
 [ (2^(1/2)*sin(x))/(x^(1/2)*pi^(1/2)), 0]
```

Plot Bessel Functions of First Kind

Plot the Bessel functions of the first kind for 0, 1, 2, 3.

```
syms x y
fplot(besselj(0:3, x))
axis([0 10 -0.5 1.1])
grid on

ylabel('J_v(x)')
legend('J_0', 'J_1', 'J_2', 'J_3', 'Location', 'Best')
title('Bessel functions of the first kind')
```

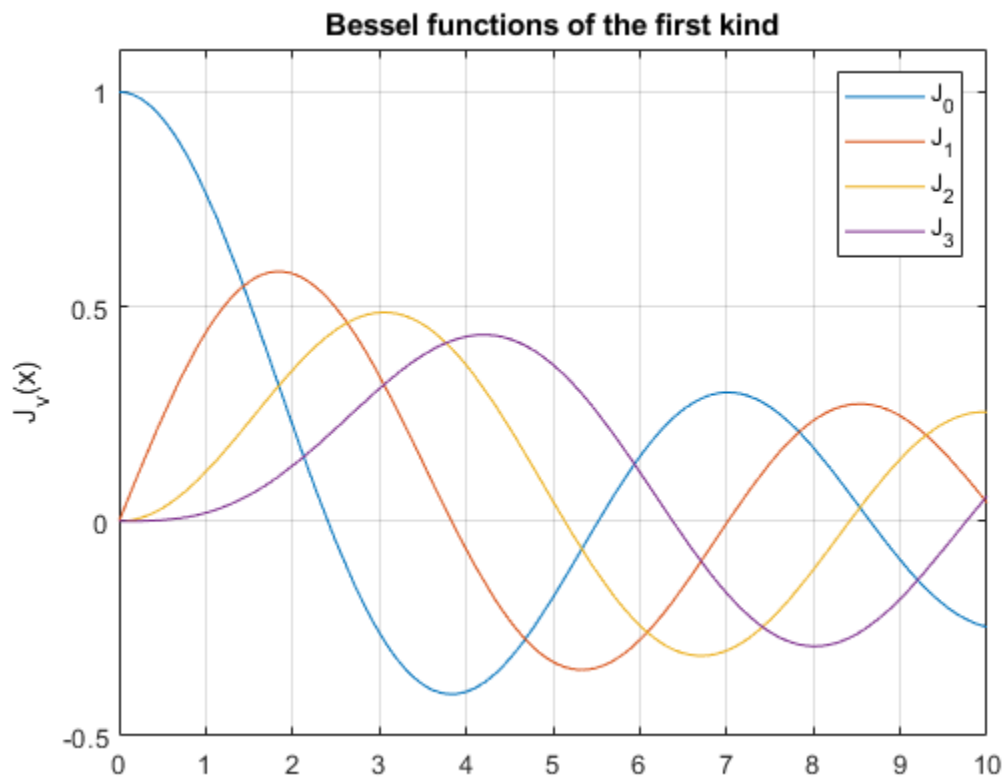

Input Arguments

nu — Input

number | vector | matrix | array | symbolic number | symbolic variable | symbolic array | symbolic function | symbolic expression

Input, specified as a number, vector, matrix, or array, or a symbolic number, variable, array, function, or expression.

If `nu` is a vector or matrix, `besselj` returns the modified Bessel function of the first kind for each element of `nu`.

z – Input

number | vector | matrix | array | symbolic number | symbolic variable | symbolic array | symbolic function | symbolic expression

Input, specified as a number, vector, matrix, or array, or a symbolic number, variable, array, function, or expression.

If `nu` is a vector or matrix, `besselj` returns the modified Bessel function of the first kind for each element of `nu`.

More About

Bessel Functions of the First Kind

The Bessel functions are solutions of the Bessel differential equation.

$$z^2 \frac{d^2 w}{dz^2} + z \frac{dw}{dz} + (z^2 - \nu^2)w = 0$$

These solutions are the Bessel functions of the first kind, $J_\nu(z)$, and the Bessel functions of the second kind, $Y_\nu(z)$.

$$w(z) = C_1 J_\nu(z) + C_2 Y_\nu(z)$$

This formula is the integral representation of the Bessel functions of the first kind.

$$J_\nu(z) = \frac{(z/2)^\nu}{\sqrt{\pi} \Gamma(\nu + 1/2)} \int_0^\pi \cos(z \cos(t)) \sin(t)^{2\nu} dt$$

Tips

- Calling `besselj` for a number that is not a symbolic object invokes the MATLAB `besselj` function.
- At least one input argument must be a scalar or both arguments must be vectors or matrices of the same size. If one input argument is a scalar and the other one is a vector or a matrix, `besselj(nu, z)` expands the scalar into a vector or matrix of the same size as the other argument with all elements equal to that scalar.

References

- [1] Olver, F. W. J. "Bessel Functions of Integer Order." *Handbook of Mathematical Functions with Formulas, Graphs, and Mathematical Tables*. (M. Abramowitz and I. A. Stegun, eds.). New York: Dover, 1972.
- [2] Antosiewicz, H. A. "Bessel Functions of Fractional Order." *Handbook of Mathematical Functions with Formulas, Graphs, and Mathematical Tables*. (M. Abramowitz and I. A. Stegun, eds.). New York: Dover, 1972.

See Also

`airy` | `besselh` | `besseli` | `besselk` | `bessely`

Introduced in R2014a

besselk

Modified Bessel function of the second kind for symbolic expressions

Syntax

```
besselk(nu, z)
```

Description

`besselk(nu, z)` returns the modified Bessel function of the second kind on page 4-126, $K_\nu(z)$.

Examples

Find Modified Bessel Function of Second Kind

Compute the modified Bessel functions of the second kind for these numbers. Because these numbers are not symbolic objects, you get floating-point results.

```
[besselk(0, 5), besselk(-1, 2), besselk(1/3, 7/4), ...
    besselk(1, 3/2 + 2*i)]
```

```
ans =
    0.0037 + 0.0000i    0.1399 + 0.0000i    0.1594 + 0.0000i   -0.1620 - 0.1066i
```

Compute the modified Bessel functions of the second kind for the numbers converted to symbolic objects. For most symbolic (exact) numbers, `besselk` returns unresolved symbolic calls.

```
[besselk(sym(0), 5), besselk(sym(-1), 2), ...
    besselk(1/3, sym(7/4)), besselk(sym(1), 3/2 + 2*i)]
```

```
ans =
[ besselk(0, 5), besselk(1, 2), besselk(1/3, 7/4), besselk(1, 3/2 + 2i)]
```

For symbolic variables and expressions, `besselk` also returns unresolved symbolic calls:

```
syms x y
[besselk(x, y), besselk(1, x^2), besselk(2, x - y), besselk(x^2, x*y)]
```

```
ans =
[ besselk(x, y), besselk(1, x^2), besselk(2, x - y), besselk(x^2, x*y)]
```

Special Values of Modified Bessel Function of Second Kind

If the first parameter is an odd integer multiplied by $1/2$, `besselk` rewrites the Bessel functions in terms of elementary functions:

```
syms x
besselk(1/2, x)
```

```
ans =
(2^(1/2)*pi^(1/2)*exp(-x))/(2*x^(1/2))
```

```
besselk(-1/2, x)
```

```
ans =
(2^(1/2)*pi^(1/2)*exp(-x))/(2*x^(1/2))
besselk(-3/2, x)
ans =
(2^(1/2)*pi^(1/2)*exp(-x)*(1/x + 1))/(2*x^(1/2))
besselk(5/2, x)
ans =
(2^(1/2)*pi^(1/2)*exp(-x)*(3/x + 3/x^2 + 1))/(2*x^(1/2))
```

Solve Bessel Differential Equation for Bessel Functions

Solve this second-order differential equation. The solutions are the modified Bessel functions of the first and the second kind.

```
syms nu w(z)
dsolve(z^2*diff(w, 2) + z*diff(w) - (z^2 + nu^2)*w == 0)
ans =
C2*besseli(nu, z) + C3*besselk(nu, z)
```

Verify that the modified Bessel function of the second kind is a valid solution of the modified Bessel differential equation:

```
syms nu z
isAlways(z^2*diff(besselk(nu, z), z, 2) + z*diff(besselk(nu, z), z)...
- (z^2 + nu^2)*besselk(nu, z) == 0)
ans =
logical
1
```

Differentiate Modified Bessel Function of Second Kind

Differentiate the expressions involving the modified Bessel functions of the second kind:

```
syms x y
diff(besselk(1, x))
diff(diff(besselk(0, x^2 + x*y - y^2), x), y)
ans =
- besselk(1, x)/x - besselk(0, x)
ans =
(2*x + y)*(besselk(0, x^2 + x*y - y^2)*(x - 2*y) +...
(besselk(1, x^2 + x*y - y^2)*(x - 2*y))/(x^2 + x*y - y^2)) - ...
besselk(1, x^2 + x*y - y^2)
```

Find Bessel Function for Matrix Input

Call `besselk` for the matrix `A` and the value `1/2`. The result is a matrix of the modified Bessel functions `besselk(1/2, A(i,j))`.

```
syms x
A = [-1, pi; x, 0];
besselk(1/2, A)
```

```
ans =
[ -(2^(1/2)*pi^(1/2)*exp(1)*1i)/2, (2^(1/2)*exp(-pi))/2]
[ (2^(1/2)*pi^(1/2)*exp(-x))/(2*x^(1/2)), Inf]
```

Plot Modified Bessel Functions of Second Kind

Plot the modified Bessel functions of the second kind for $\nu = 0, 1, 2, 3$.

```
syms x y
fplot(besselk(0:3, x))
axis([0 4 0 4])
grid on

ylabel('K_v(x)')
legend('K_0','K_1','K_2','K_3', 'Location','Best')
title('Modified Bessel functions of the second kind')
```

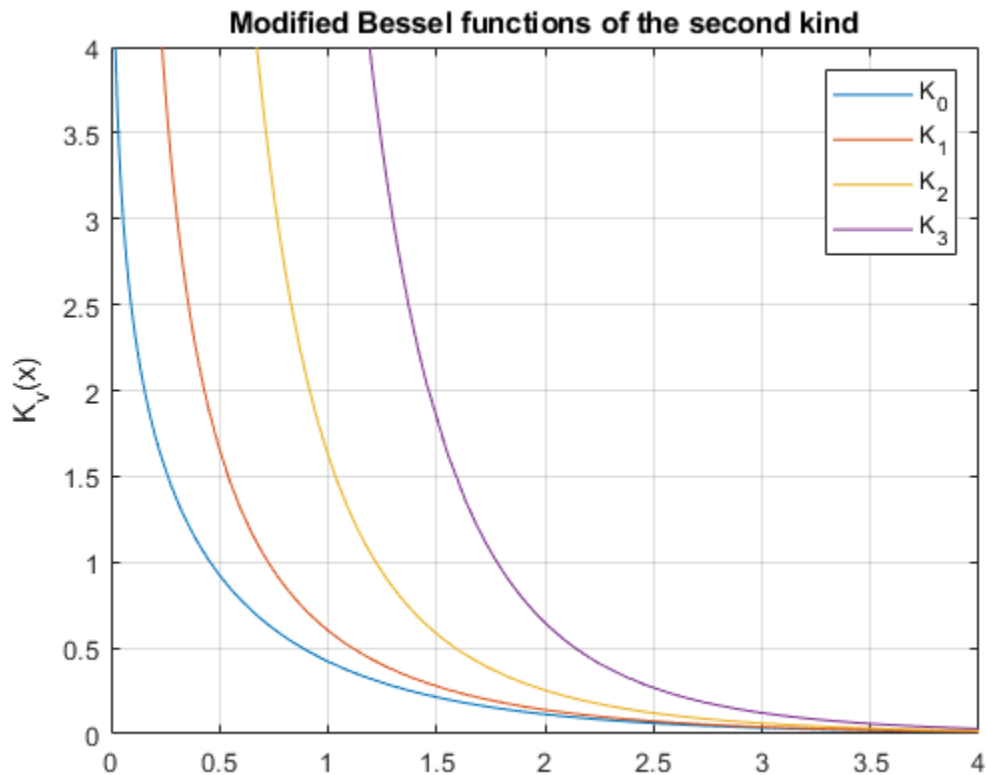

Input Arguments

nu – Input

number | vector | matrix | multidimensional array | symbolic number | symbolic array | symbolic function | symbolic expression

Input, specified as a number, vector, matrix, array, or a symbolic number, variable, expression, function, or array. If nu is a vector or matrix, `besselk` returns the modified Bessel function of the first kind for each element of nu.

z – Input

number | vector | matrix | multidimensional array | symbolic number | symbolic array | symbolic function | symbolic expression

Input, specified as a number, vector, matrix, array, or a symbolic number, variable, expression, function, or array. If `nu` is a vector or matrix, `besseli` returns the modified Bessel function of the first kind for each element of `nu`.

More About**Modified Bessel Functions of the Second Kind**

The modified Bessel differential equation

$$z^2 \frac{d^2 w}{dz^2} + z \frac{dw}{dz} - (z^2 + \nu^2)w = 0$$

has two linearly independent solutions. These solutions are represented by the modified Bessel functions of the first kind, $I_\nu(z)$, and the modified Bessel functions of the second kind, $K_\nu(z)$:

$$w(z) = C_1 I_\nu(z) + C_2 K_\nu(z)$$

The modified Bessel functions of the second kind are defined via the modified Bessel functions of the first kind:

$$K_\nu(z) = \frac{\pi/2}{\sin(\nu\pi)} (I_{-\nu}(z) - I_\nu(z))$$

Here $I_\nu(z)$ are the modified Bessel functions of the first kind:

$$I_\nu(z) = \frac{(z/2)^\nu}{\sqrt{\pi}\Gamma(\nu + 1/2)} \int_0^\pi e^{z\cos(t)} \sin(t)^{2\nu} dt$$

Tips

- Calling `besselk` for a number that is not a symbolic object invokes the MATLAB `besselk` function.
- At least one input argument must be a scalar or both arguments must be vectors or matrices of the same size. If one input argument is a scalar and the other one is a vector or a matrix, `besselk(nu, z)` expands the scalar into a vector or matrix of the same size as the other argument with all elements equal to that scalar.

References

- [1] Olver, F. W. J. "Bessel Functions of Integer Order." *Handbook of Mathematical Functions with Formulas, Graphs, and Mathematical Tables*. (M. Abramowitz and I. A. Stegun, eds.). New York: Dover, 1972.
- [2] Antosiewicz, H. A. "Bessel Functions of Fractional Order." *Handbook of Mathematical Functions with Formulas, Graphs, and Mathematical Tables*. (M. Abramowitz and I. A. Stegun, eds.). New York: Dover, 1972.

See Also

`airy` | `besselh` | `besseli` | `besselj` | `bessely`

Introduced in R2014a

bessely

Bessel function of the second kind for symbolic expressions

Syntax

`bessely(nu, z)`

Description

`bessely(nu, z)` returns the Bessel function of the second kind on page 4-131, $Y_\nu(z)$.

Examples

Find Bessel Function of Second Kind

Compute the Bessel functions of the second kind for these numbers. Because these numbers are not symbolic objects, you get floating-point results.

```
[bessely(0, 5), bessely(-1, 2), bessely(1/3, 7/4), bessely(1, 3/2 + 2*i)]
```

```
ans =
-0.3085 + 0.0000i  0.1070 + 0.0000i  0.2358 + 0.0000i  -0.4706 + 1.5873i
```

Compute the Bessel functions of the second kind for the numbers converted to symbolic objects. For most symbolic (exact) numbers, `bessely` returns unresolved symbolic calls.

```
[bessely(sym(0), 5), bessely(sym(-1), 2), ...
bessely(1/3, sym(7/4)), bessely(sym(1), 3/2 + 2*i)]
```

```
ans =
[ bessely(0, 5), -bessely(1, 2), bessely(1/3, 7/4), bessely(1, 3/2 + 2i)]
```

For symbolic variables and expressions, `bessely` also returns unresolved symbolic calls:

```
syms x y
[bessely(x, y), bessely(1, x^2), bessely(2, x - y), bessely(x^2, x*y)]
```

```
ans =
[ bessely(x, y), bessely(1, x^2), bessely(2, x - y), bessely(x^2, x*y)]
```

Solve Bessel Differential Equation for Bessel Functions

Solve this second-order differential equation. The solutions are the Bessel functions of the first and the second kind.

```
syms nu w(z)
dsolve(z^2*diff(w, 2) + z*diff(w) +(z^2 - nu^2)*w == 0)
```

```
ans =
C2*besselj(nu, z) + C3*bessely(nu, z)
```

Verify that the Bessel function of the second kind is a valid solution of the Bessel differential equation:

```

syms nu z
isAlways(z^2*diff(bessely(nu, z), z, 2) + z*diff(bessely(nu, z), z)...
+ (z^2 - nu^2)*bessely(nu, z) == 0)

ans =
    logical
     1

```

Special Values of Bessel Function of Second Kind

If the first parameter is an odd integer multiplied by 1/2, `bessely` rewrites the Bessel functions in terms of elementary functions:

```

syms x
bessely(1/2, x)

ans =
-(2^(1/2)*cos(x))/(x^(1/2)*pi^(1/2))

bessely(-1/2, x)

ans =
(2^(1/2)*sin(x))/(x^(1/2)*pi^(1/2))

bessely(-3/2, x)

ans =
(2^(1/2)*(cos(x) - sin(x)/x))/(x^(1/2)*pi^(1/2))

bessely(5/2, x)

ans =
-(2^(1/2)*((3*sin(x))/x + cos(x)*(3/x^2 - 1)))/(x^(1/2)*pi^(1/2))

```

Differentiate Bessel Functions of Second Kind

Differentiate the expressions involving the Bessel functions of the second kind:

```

syms x y
diff(bessely(1, x))
diff(diff(bessely(0, x^2 + x*y - y^2), x), y)

ans =
bessely(0, x) - bessely(1, x)/x

ans =
- bessely(1, x^2 + x*y - y^2) - ...
(2*x + y)*(bessely(0, x^2 + x*y - y^2)*(x - 2*y) - ...
(bessely(1, x^2 + x*y - y^2)*(x - 2*y)))/(x^2 + x*y - y^2)

```

Find Bessel Function for Matrix Input

Call `bessely` for the matrix `A` and the value 1/2. The result is a matrix of the Bessel functions `bessely(1/2, A(i,j))`.

```

syms x
A = [-1, pi; x, 0];
bessely(1/2, A)

```

```
ans =
[ (2^(1/2)*cos(1)*1i)/pi^(1/2), 2^(1/2)/pi]
[ -(2^(1/2)*cos(x))/(x^(1/2)*pi^(1/2)), Inf]
```

Plot Bessel Functions of Second Kind

Plot the Bessel functions of the second kind for $\nu = 0, 1, 2, 3$.

```
syms x y
fplot(bessely(0:3,x))
axis([0 10 -1 0.6])
grid on

ylabel('Y_v(x)')
legend('Y_0','Y_1','Y_2','Y_3', 'Location','Best')
title('Bessel functions of the second kind')
```

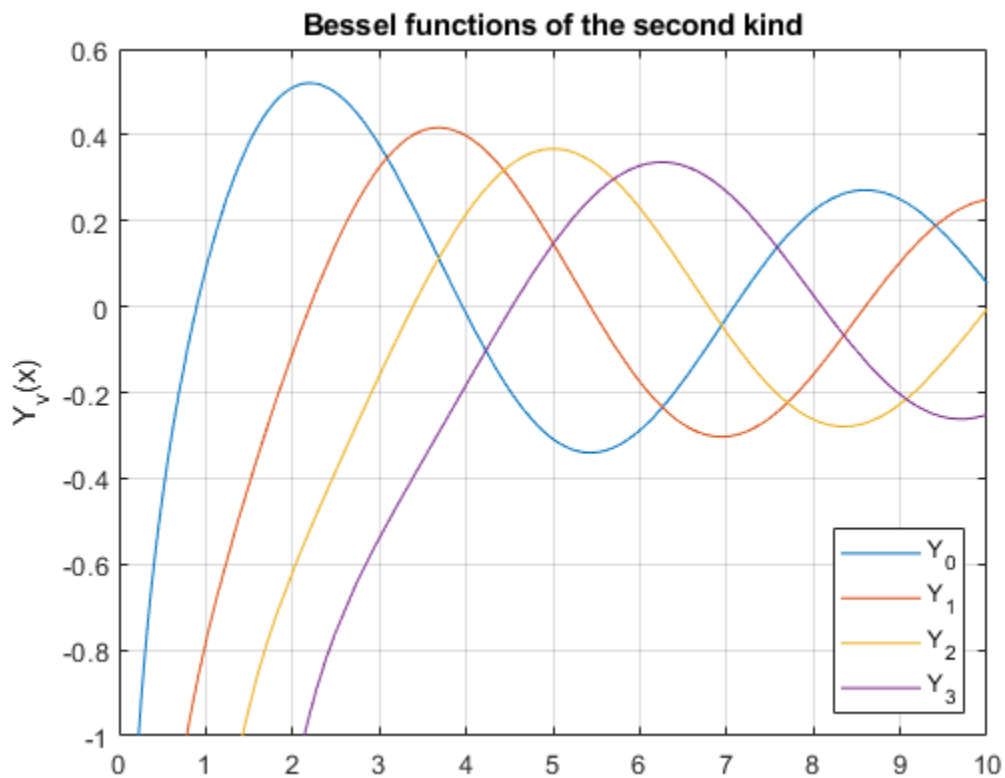

Input Arguments

nu – Input

number | vector | matrix | array | symbolic number | symbolic variable | symbolic array | symbolic function | symbolic expression

Input, specified as a number, vector, matrix, or array, or a symbolic number, variable, array, function, or expression.

If `nu` is a vector or matrix, `bessely` returns the Bessel function of the second kind for each element of `nu`.

z — Input

number | vector | matrix | array | symbolic number | symbolic variable | symbolic array | symbolic function | symbolic expression

Input, specified as a number, vector, matrix, or array, or a symbolic number, variable, array, function, or expression.

If `z` is a vector or matrix, `bessely` returns the Bessel function of the second kind for each element of `z`.

More About

Bessel Function of the Second Kind

The Bessel differential equation

$$z^2 \frac{d^2 w}{dz^2} + z \frac{dw}{dz} + (z^2 - \nu^2)w = 0$$

has two linearly independent solutions. These solutions are represented by the Bessel functions of the first kind, $J_\nu(z)$, and the Bessel functions of the second kind, $Y_\nu(z)$:

$$w(z) = C_1 J_\nu(z) + C_2 Y_\nu(z)$$

The Bessel functions of the second kind are defined via the Bessel functions of the first kind:

$$Y_\nu(z) = \frac{J_\nu(z)\cos(\nu\pi) - J_{-\nu}(z)}{\sin(\nu\pi)}$$

Here $J_\nu(z)$ are the Bessel function of the first kind:

$$J_\nu(z) = \frac{(z/2)^\nu}{\sqrt{\pi}\Gamma(\nu + 1/2)} \int_0^\pi \cos(z\cos(t))\sin(t)^{2\nu} dt$$

Tips

- Calling `bessely` for a number that is not a symbolic object invokes the MATLAB `bessely` function.

At least one input argument must be a scalar or both arguments must be vectors or matrices of the same size. If one input argument is a scalar and the other one is a vector or a matrix, `bessely(nu, z)` expands the scalar into a vector or matrix of the same size as the other argument with all elements equal to that scalar.

References

- [1] Olver, F. W. J. "Bessel Functions of Integer Order." *Handbook of Mathematical Functions with Formulas, Graphs, and Mathematical Tables*. (M. Abramowitz and I. A. Stegun, eds.). New York: Dover, 1972.

[2] Antosiewicz, H. A. "Bessel Functions of Fractional Order." *Handbook of Mathematical Functions with Formulas, Graphs, and Mathematical Tables*. (M. Abramowitz and I. A. Stegun, eds.). New York: Dover, 1972.

See Also

airy | besselh | besseli | besselj | bessellk

Introduced in R2014a

beta

Beta function

Syntax

`beta(x,y)`

Description

`beta(x,y)` returns the beta function on page 4-135 of x and y .

Examples

Compute Beta Function for Numeric Inputs

Compute the beta function for these numbers. Because these numbers are not symbolic objects, you get floating-point results:

```
[beta(1, 5), beta(3, sqrt(2)), beta(pi, exp(1)), beta(0, 1)]
```

```
ans =
    0.2000    0.1716    0.0379    Inf
```

Compute Beta Function for Symbolic Inputs

Compute the beta function for the numbers converted to symbolic objects:

```
[beta(sym(1), 5), beta(3, sym(2)), beta(sym(4), sym(4))]
```

```
ans =
[ 1/5, 1/12, 1/140]
```

If one or both parameters are complex numbers, convert these numbers to symbolic objects:

```
[beta(sym(i), 3/2), beta(sym(i), i), beta(sym(i + 2), 1 - i)]
```

```
ans =
[ (pi^(1/2)*gamma(1i))/(2*gamma(3/2 + 1i)), gamma(1i)^2/gamma(2i),...
  (pi*(1/2 + 1i/2))/sinh(pi)]
```

Compute Beta Function for Negative Parameters

Compute the beta function for negative parameters. If one or both arguments are negative numbers, convert these numbers to symbolic objects:

```
[beta(sym(-3), 2), beta(sym(-1/3), 2), beta(sym(-3), 4), beta(sym(-3), -2)]
```

```
ans =
[ 1/6, -9/2, Inf, Inf]
```

Compute Beta Function for Matrix Inputs

Call `beta` for the matrix A and the value 1. The result is a matrix of the beta functions `beta(A(i,j),1)`:

```
A = sym([1 2; 3 4]);  
beta(A,1)
```

```
ans =  
[ 1, 1/2]  
[ 1/3, 1/4]
```

Differentiate Beta Function

Differentiate the beta function, then substitute the variable t with the value $2/3$ and approximate the result using `vpa`:

```
syms t  
u = diff(beta(t^2 + 1, t))  
vpa(subs(u, t, 2/3), 10)  
  
u =  
beta(t, t^2 + 1)*(psi(t) + 2*t*psi(t^2 + 1) - ...  
psi(t^2 + t + 1)*(2*t + 1))  
  
ans =  
-2.836889094
```

Expand Beta Function

Expand these beta functions:

```
syms x y  
expand(beta(x, y))  
expand(beta(x + 1, y - 1))  
  
ans =  
(gamma(x)*gamma(y))/gamma(x + y)  
  
ans =  
-(x*gamma(x)*gamma(y))/(gamma(x + y) - y*gamma(x + y))
```

Input Arguments

x — Input

number | vector | matrix | array | symbolic number | symbolic variable | symbolic array | symbolic function | symbolic expression

Input, specified as a number, vector, matrix, or array, or a symbolic number, variable, array, function, or expression.

If x is a vector or matrix, `beta` returns the beta function for each element of x .

y — Input

number | vector | matrix | array | symbolic number | symbolic variable | symbolic array | symbolic function | symbolic expression

Input, specified as a number, vector, matrix, or array, or a symbolic number, variable, array, function, or expression.

If y is a vector or matrix, `beta` returns the beta function for each element of y .

More About

Beta Function

This integral defines the beta function:

$$B(x, y) = \int_0^1 t^{x-1} (1-t)^{y-1} dt = \frac{\Gamma(x)\Gamma(y)}{\Gamma(x+y)}$$

Tips

- The beta function is uniquely defined for positive numbers and complex numbers with positive real parts. It is approximated for other numbers.
- Calling `beta` for numbers that are not symbolic objects invokes the MATLAB `beta` function. This function accepts real arguments only. If you want to compute the beta function for complex numbers, use `sym` to convert the numbers to symbolic objects, and then call `beta` for those symbolic objects.
- If one or both parameters are negative numbers, convert these numbers to symbolic objects using `sym`, and then call `beta` for those symbolic objects.
- If the beta function has a singularity, `beta` returns the positive infinity `Inf`.
- `beta(sym(0), 0)`, `beta(0, sym(0))`, and `beta(sym(0), sym(0))` return `NaN`.
- `beta(x, y) = beta(y, x)` and `beta(x, A) = beta(A, x)`.
- At least one input argument must be a scalar or both arguments must be vectors or matrices of the same size. If one input argument is a scalar and the other one is a vector or a matrix, `beta(x, y)` expands the scalar into a vector or matrix of the same size as the other argument with all elements equal to that scalar.

References

- [1] Zelen, M. and N. C. Severo. "Probability Functions." *Handbook of Mathematical Functions with Formulas, Graphs, and Mathematical Tables*. (M. Abramowitz and I. A. Stegun, eds.). New York: Dover, 1972.

See Also

`factorial` | `gamma` | `nchoosek` | `psi`

Introduced in R2014a

cat

Concatenate symbolic arrays along specified dimension

Syntax

```
cat(dim,A1,...,AN)
```

Description

`cat(dim,A1,...,AN)` concatenates the arrays A_1, \dots, A_N along dimension `dim`. The remaining dimensions must be the same size.

Examples

Concatenate Two Vectors into Matrix

Create vectors A and B.

```
A = sym('a%d',[1 4])
B = sym('b%d',[1 4])
```

```
A =
[ a1, a2, a3, a4]
B =
[ b1, b2, b3, b4]
```

To concatenate A and B into a matrix, specify dimension `dim` as 1.

```
cat(1,A,B)
```

```
ans =
[ a1, a2, a3, a4]
[ b1, b2, b3, b4]
```

Alternatively, use the syntax `[A;B]`.

```
[A;B]
ans =
[ a1, a2, a3, a4]
[ b1, b2, b3, b4]
```

Concatenate Two Vectors into One Vector

To concatenate two vectors into one vector, specify dimension `dim` as 2.

```
A = sym('a%d',[1 4]);
B = sym('b%d',[1 4]);
cat(2,A,B)
```

```
ans =
[ a1, a2, a3, a4, b1, b2, b3, b4]
```

Alternatively, use the syntax `[A B]`.

```
[A B]
ans =
[ a1, a2, a3, a4, b1, b2, b3, b4]
```

Concatenate Multidimensional Arrays Along Their Third Dimension

Create arrays A and B.

```
A = sym('a%d%d',[2 2]);
A(:,:,2) = -A
B = sym('b%d%d',[2 2]);
B(:,:,2) = -B
```

```
A(:,:,1) =
[ a11, a12]
[ a21, a22]
A(:,:,2) =
[ -a11, -a12]
[ -a21, -a22]
```

```
B(:,:,1) =
[ b11, b12]
[ b21, b22]
B(:,:,2) =
[ -b11, -b12]
[ -b21, -b22]
```

Concatenate A and B by specifying dimension `dim` as 3.

```
cat(3,A,B)
```

```
ans(:,:,1) =
[ a11, a12]
[ a21, a22]
ans(:,:,2) =
[ -a11, -a12]
[ -a21, -a22]
ans(:,:,3) =
[ b11, b12]
[ b21, b22]
ans(:,:,4) =
[ -b11, -b12]
[ -b21, -b22]
```

Input Arguments

dim — Dimension to concatenate arrays along

positive integer

Dimension to concatenate arrays along, specified as a positive integer.

A1, ..., AN — Input arrays

symbolic variables | symbolic vectors | symbolic matrices | symbolic multidimensional arrays

Input arrays, specified as symbolic variables, vectors, matrices, or multidimensional arrays.

See Also

horzcat | reshape | vertcat

Introduced in R2010b

catalan

Catalan constant

Syntax

catalan

Description

catalan represents the Catalan constant on page 4-139. To get a floating-point approximation with the current precision set by `digits`, use `vpa(catalan)`.

Examples

Approximate Catalan Constant

Find a floating-point approximation of the Catalan constant with the default number of digits and with the 10-digit precision.

Use `vpa` to approximate the Catalan constant with the default 32-digit precision:

```
vpa(catalan)

ans =
0.91596559417721901505460351493238
```

Set the number of digits to 10 and approximate the Catalan constant:

```
old = digits(10);
vpa(catalan)

ans =
0.9159655942
```

Restore the default number of digits:

```
digits(old)
```

More About

Catalan Constant

The Catalan constant is defined as follows:

$$\text{catalan} = \sum_{i=0}^{\infty} \frac{(-1)^i}{(2i+1)^2} = \frac{1}{1^2} - \frac{1}{3^2} + \frac{1}{5^2} - \frac{1}{7^2} + \dots$$

See Also

`dilog` | `eulergamma`

Introduced in R2014a

ccode

C code representation of symbolic expression

Syntax

```
ccode(f)
ccode(f, Name, Value)
```

Description

`ccode(f)` returns C code for the symbolic expression `f`.

`ccode(f, Name, Value)` uses additional options specified by one or more `Name, Value` pair arguments.

Examples

Generate C Code from Symbolic Expression

Generate C code from the symbolic expression $\log(1+x)$.

```
syms x
f = log(1+x);
ccode(f)

ans =
    ' t0 = log(x+1.0);'
```

Generate C code for the 3-by-3 Hilbert matrix.

```
H = sym(hilb(3));
ccode(H)

ans =
    ' H[0][0] = 1.0;
      H[0][1] = 1.0/2.0;
      H[0][2] = 1.0/3.0;
      H[1][0] = 1.0/2.0;
      H[1][1] = 1.0/3.0;
      H[1][2] = 1.0/4.0;
      H[2][0] = 1.0/3.0;
      H[2][1] = 1.0/4.0;
      H[2][2] = 1.0/5.0;'
```

Initialize Arrays Efficiently

Because generated C code initializes only non-zero elements, you can efficiently initialize arrays by setting all elements to 0 directly in your C code. Then, use the generated C code to initialize only nonzero elements. This approach enables efficient initialization of matrices, especially sparse matrices.

Initialize the 3-by-3 identity matrix. First initialize the matrix with all elements set to 0 in your C code. Then use the generated C code to initialize the nonzero values.

```
I3 = sym(eye(3));
I3code = ccode(I3)

I3code =
' I3[0][0] = 1.0;
  I3[1][1] = 1.0;
  I3[2][2] = 1.0;'
```

Write Optimized C Code to File with Comments

Write C code to the file `ccodetest.c` by specifying the `File` option. When writing to a file, `ccode` optimizes the code by using intermediate variables named `t0`, `t1`, and so on.

```
syms x
f = diff(tan(x));
ccode(f,'File','ccodetest.c')

t0 = pow(tan(x),2.0)+1.0;
```

Include the comment `Version: 1.1` in the file by using the `Comments` option. `ccode` uses block comments.

```
ccode(f,'File','ccodetest.c','Comments','Version: 1.1')

/*
Version: 1.1
*/
t0 = pow(tan(x),2.0)+1.0;
```

Input Arguments

f — Symbolic input

symbolic expression

Symbolic input, specified as a symbolic expression.

Name-Value Pair Arguments

Specify optional comma-separated pairs of `Name`, `Value` arguments. `Name` is the argument name and `Value` is the corresponding value. `Name` must appear inside quotes. You can specify several name and value pair arguments in any order as `Name1, Value1, ..., NameN, ValueN`.

Example: `ccode(x^2,'File','ccode.c','Comments','V1.2')`

File — File to write to

character vector | string

File to write to, specified as a character vector or string. When writing to a file, `ccode` optimizes the code by using intermediate variables named `t0`, `t1`, and so on.

Comments — Comments to include in file header

character vector | cell array of character vectors | string vector

Comments to include in the file header, specified as a character vector, cell array of character vectors, or string vector. Because ccode uses block comments, the comments must not contain `/*` or `*/`.

See Also

`fortran` | `latex` | `matlabFunction`

Introduced before R2006a

cell2sym

Convert cell array to symbolic array

Syntax

```
S = cell2sym(C)
S = cell2sym(C, flag)
```

Description

`S = cell2sym(C)` converts a cell array `C` to a symbolic array `S`. The elements of `C` must be convertible to symbolic objects.

If each element of the input cell array `C` is a scalar, then `size(S) = size(C)`, and `S(k) = sym(C(k))` for all indices `k`. If the cell array `C` contains nonscalar elements, then the contents of `C` must support concatenation into an `N`-dimensional rectangle. Otherwise, the results are undefined. For example, the contents of cells in the same column must have the same number of columns. However, they do not need to have the same number of rows. See figure.

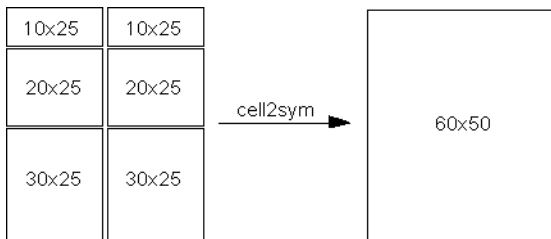

`S = cell2sym(C, flag)` uses the technique specified by `flag` for converting floating-point numbers to symbolic numbers.

Examples

Convert Cell Array of Scalars

Convert a cell array of only scalar elements to a symbolic array.

Create a cell array of scalar elements.

```
C = {'x', 'y', 'z'; 1 2 3}
```

```
C =
  2x3 cell array
    {'x'}    {'y'}    {'z'}
    {[1]}    {[2]}    {[3]}
```

Convert this cell array to a symbolic array.

```
S = cell2sym(C)
```

```
S =
 [ x, y, z]
 [ 1, 2, 3]
```

`cell2sym` does not create symbolic variables `x`, `y`, and `z` in the MATLAB workspace. To access an element of `S`, use parentheses.

```
S(1,1)
```

```
ans =
 x
```

Convert Cell Array Containing Nonscalar Elements

Convert a cell array whose elements are scalars, vectors, and matrices into a symbolic array. Such conversion is possible only if the contents of the cell array can be concatenated into an N-dimensional rectangle.

Create a cell array, the elements of which are a scalar, a row vector, a column vector, and a matrix.

```
C = {'x' [2 3 4]; ['y'; sym(9)] [6 7 8; 10 11 12]}
```

```
C =
 2x2 cell array
 {'x'      } {1x3 double}
 {2x1 sym} {2x3 double}
```

Convert this cell array to a symbolic array.

```
S = cell2sym(C)
```

```
S =
 [ x, 2, 3, 4]
 [ y, 6, 7, 8]
 [ 9, 10, 11, 12]
```

Choose Conversion Technique for Floating-Point Values

When converting a cell array containing floating-point numbers, you can explicitly specify the conversion technique.

Create a cell array `pi` with two elements: the double-precision value of the constant `pi` and the exact value `pi`.

```
C = {pi, sym(pi)}
```

```
C =
 1x2 cell array
 {[3.1416]} {1x1 sym}
```

Convert this cell array to a symbolic array. By default, `cell2sym` uses the rational conversion mode. Thus, results returned by `cell2sym` without a flag are the same as results returned by `cell2sym` with the flag `'r'`.

```
S = cell2sym(C)
```

```
S =
 [ pi, pi]
```

```
S = cell2sym(C, 'r')
```

```
S =
[ pi, pi]
```

Convert the same cell array to a symbolic array using the flags 'd', 'e', and 'f'. See the “Input Arguments” on page 4-146 section for the details about conversion techniques.

```
S = cell2sym(C, 'd')
```

```
S =
[ 3.1415926535897931159979634685442, pi]
```

```
S = cell2sym(C, 'e')
```

```
S =
[ pi - (198*eps)/359, pi]
```

```
S = cell2sym(C, 'f')
```

```
S =
[ 884279719003555/281474976710656, pi]
```

Input Arguments

C — Input cell array

cell array

Input cell array, specified as a cell array. The elements of C must be convertible to symbolic objects.

flag — Conversion technique

'r' (default) | 'd' | 'e' | 'f'

Conversion technique, specified as one of the characters listed in this table.

'r'	In the <i>rational</i> mode, <code>cell2sym</code> converts floating-point numbers obtained by evaluating expressions of the form p/q , $p*\pi/q$, \sqrt{p} , 2^q , and 10^q for modest sized integers p and q to the corresponding symbolic form. This approach effectively compensates for the round-off error involved in the original evaluation, but might not represent the floating-point value precisely. If <code>cell2sym</code> cannot find simple rational approximation, then it uses the same technique as it would use with the flag 'f'.
'd'	In the <i>decimal</i> mode, <code>cell2sym</code> takes the number of digits from the current setting of <code>digits</code> . Conversions with fewer than 16 digits lose some accuracy, while more than 16 digits might not be warranted. For example, <code>cell2sym({4/3}, 'd')</code> with the 10-digit accuracy returns 1.33333333, while with the 20-digit accuracy it returns 1.333333333333332593. The latter does not end in 3s, but it is an accurate decimal representation of the floating-point number nearest to 4/3.
'e'	In the <i>estimate error</i> mode, <code>cell2sym</code> supplements a result obtained in the rational mode by a term involving the variable <code>eps</code> . This term estimates the difference between the theoretical rational expression and its actual floating-point value. For example, <code>cell2sym({3*pi/4}, 'e')</code> returns $(3*\pi)/4 - (103*\text{eps})/249$.

'f'	In the <i>floating-point</i> mode, <code>cell2sym</code> represents all values in the form $N \cdot 2^e$ or $-N \cdot 2^e$, where $N \geq 0$ and e are integers. For example, <code>cell2sym({1/10}, 'f')</code> returns <code>3602879701896397/36028797018963968</code> . The returned rational value is the exact value of the floating-point number that you convert to a symbolic number.
-----	--

Output Arguments

S — Resulting symbolic array

symbolic array

Resulting symbolic array, returned as a symbolic array.

See Also

`cell2mat` | `mat2cell` | `num2cell` | `sym2cell`

Introduced in R2016a

changeIntegrationVariable

Integration by substitution

Syntax

`G = changeIntegrationVariable(F,old,new)`

Description

`G = changeIntegrationVariable(F,old,new)` applies integration by substitution to the integrals in `F`, in which `old` is replaced by `new`. `old` must depend on the previous integration variable of the integrals in `F` and `new` must depend on the new integration variable. For more information, see “Integration by Substitution” on page 4-151.

When specifying the integrals in `F`, you can return the unevaluated form of the integrals by using the `int` function with the 'Hold' option set to `true`. You can then use `changeIntegrationVariable` to show the steps of integration by substitution.

Examples

Change of Variable

Apply a change of variable to the definite integral $\int_a^b f(x+c) dx$.

Define the integral.

```
syms f(x) y a b c
F = int(f(x+c),a,b)
```

F =

$$\int_a^b f(c+x) dx$$

Change the variable $x+c$ in the integral to y .

```
G = changeIntegrationVariable(F,x+c,y)
```

G =

$$\int_{a+c}^{b+c} f(y) dy$$

Integration by Substitution

Find the integral of $f \cos(\log(x)) dx$ using integration by substitution.

Define the integral without evaluating it by setting the 'Hold' option to `true`.

```
syms x t
F = int(cos(log(x)), 'Hold', true)
```

$$F = \int \cos(\log(x)) dx$$

Substitute the expression $\log(x)$ with t .

```
G = changeIntegrationVariable(F, log(x), t)
```

$$G = \int e^t \cos(t) dt$$

To evaluate the integral in G , use the `release` function to ignore the 'Hold' option.

```
H = release(G)
```

$$H = \frac{e^t (\cos(t) + \sin(t))}{2}$$

Restore $\log(x)$ in place of t .

```
H = simplify(subs(H, t, log(x)))
```

$$H = \frac{\sqrt{2} x \sin\left(\frac{\pi}{4} + \log(x)\right)}{2}$$

Compare the result to the integration result returned by `int` without setting the 'Hold' option to `true`.

```
Fcalc = int(cos(log(x)))
```

$$Fcalc = \frac{\sqrt{2} x \sin\left(\frac{\pi}{4} + \log(x)\right)}{2}$$

Find Closed-Form Solution

Find the closed-form solution of the integral $\int x \tan(\log(x)) dx$.

Define the integral using the `int` function.

```
syms x
F = int(x*tan(log(x)), x)
```

$$F = \int x \tan(\log(x)) dx$$

The `int` function cannot find the closed-form solution of the integral.

Substitute the expression $\log(x)$ with t . Apply integration by substitution.

```
syms t
G = changeIntegrationVariable(F, log(x), t)
```

$$G = \frac{e^{2t} {}_2F_1(1, -i; 1 - i; -e^{2ti})}{2} + e^{t(2+2i)} {}_2F_1(1, 1-i; 2-i; -e^{2ti}) \left(-\frac{1}{4} - \frac{1}{4}i\right)$$

The closed-form solution is expressed in terms of hypergeometric functions. For more details on hypergeometric functions, see `hypergeom`.

Numerical Integration with High Precision

Compute the integral $\int_0^1 e^{\sqrt{\sin(x)}} dx$ numerically with high precision.

Define the integral $\int_0^1 e^{\sqrt{\sin(x)}} dx$. A closed-form solution to the integral does not exist.

```
syms x
F = int(exp(sqrt(sin(x))), x, 0, 1)
```

$$F = \int_0^1 e^{\sqrt{\sin(x)}} dx$$

You can use `vpa` to compute the integral numerically to 10 significant digits.

```
F10 = vpa(F, 10)
```

```
F10 = 1.944268879
```

Alternatively, you can use the `vpaintegral` function and specify the relative error tolerance.

```
Fvpa = vpaintegral(exp(sqrt(sin(x))), x, 0, 1, 'RelTol', 1e-10)
```

```
Fvpa = 1.944268879
```

The `vpa` function cannot find the numerical integration to 70 significant digits and it returns the unevaluated integral.

```
F70 = vpa(F, 70)
```

$$F70 = \int_0^1 e^{\sqrt{\sin(x)}} dx$$

To find the numerical integration with high precision, you can perform a change of variable. Substitute the expression $\sqrt{\sin(x)}$ with t . Compute the integral numerically to 70 significant digits.

```
syms t;
G = changeIntegrationVariable(F, sqrt(sin(x)), t)
```

$$G = \int_0^{\sqrt{\sin(1)}} \frac{2t e^t}{\sqrt{1-t^4}} dt$$

```
G70 = vpa(G, 70)
```

G70 = 1.944268879138581167466225761060083173280747314051712224507065962575967

Input Arguments

F — Expression containing integrals

symbolic expression | symbolic function | symbolic vector | symbolic matrix

Expression containing integrals, specified as a symbolic expression, function, vector, or matrix.

old — Subexpression to be substituted

symbolic scalar variable | symbolic expression | symbolic function

Subexpression to be substituted, specified as a symbolic scalar variable, expression, or function. `old` must depend on the previous integration variable of the integrals in `F`.

new — New subexpression

symbolic scalar variable | symbolic expression | symbolic function

New subexpression, specified as a symbolic scalar variable, expression, or function. `new` must depend on the new integration variable.

More About

Integration by Substitution

Mathematically, the substitution rule is formally defined for indefinite integrals as

$$\int f(g(x)) g'(x) dx = \left(\int f(t) dt \right) \Big|_{t=g(x)}$$

and for definite integrals as

$$\int_a^b f(g(x)) g'(x) dx = \int_{g(a)}^{g(b)} f(t) dt.$$

See Also

`diff` | `int` | `integrateByParts` | `release` | `vpaintegral`

Introduced in R2019b

charpoly

Characteristic polynomial of matrix

Syntax

```
charpoly(A)  
charpoly(A,var)
```

Description

`charpoly(A)` returns a vector of coefficients of the characteristic polynomial on page 4-153 of A. If A is a symbolic matrix, `charpoly` returns a symbolic vector. Otherwise, it returns a vector of double-precision values.

`charpoly(A,var)` returns the characteristic polynomial of A in terms of `var`.

Examples

Compute Coefficients of Characteristic Polynomial of Matrix

Compute the coefficients of the characteristic polynomial of A by using `charpoly`.

```
A = [1 1 0; 0 1 0; 0 0 1];  
charpoly(A)
```

```
ans =  
     1     -3     3     -1
```

For symbolic input, `charpoly` returns a symbolic vector instead of double. Repeat the calculation for symbolic input.

```
A = sym(A);  
charpoly(A)
```

```
ans =  
[ 1, -3, 3, -1]
```

Compute Characteristic Polynomial of Matrix

Compute the characteristic polynomial of the matrix A in terms of x.

```
syms x  
A = sym([1 1 0; 0 1 0; 0 0 1]);  
polyA = charpoly(A,x)
```

```
polyA =  
x^3 - 3*x^2 + 3*x - 1
```

Solve the characteristic polynomial for the eigenvalues of A.

```
eigenA = solve(polyA)
```

```
eigenA =
  1
  1
  1
```

Input Arguments

A — Input

numeric matrix | symbolic matrix

Input, specified as a numeric or symbolic matrix.

var — Polynomial variable

symbolic variable

Polynomial variable, specified as a symbolic variable.

More About

Characteristic Polynomial of Matrix

The characteristic polynomial of an n -by- n matrix A is the polynomial $p_A(x)$, defined as follows.

$$p_A(x) = \det(xI_n - A)$$

Here, I_n is the n -by- n identity matrix.

References

- [1] Cohen, H. "A Course in Computational Algebraic Number Theory." *Graduate Texts in Mathematics* (Axler, Sheldon and Ribet, Kenneth A., eds.). Vol. 138, Springer, 1993.
- [2] Abdeljaoued, J. "The Berkowitz Algorithm, Maple and Computing the Characteristic Polynomial in an Arbitrary Commutative Ring." *MapleTech*, Vol. 4, Number 3, pp 21-32, Birkhauser, 1997.

See Also

det | eig | jordan | minpoly | poly2sym | sym2poly

Introduced in R2012b

chebyshevT

Chebyshev polynomials of the first kind

Syntax

`chebyshevT(n, x)`

Description

`chebyshevT(n, x)` represents the n th degree Chebyshev polynomial of the first kind on page 4-156 at the point x .

Examples

First Five Chebyshev Polynomials of the First Kind

Find the first five Chebyshev polynomials of the first kind for the variable x .

```
syms x
chebyshevT([0, 1, 2, 3, 4], x)

ans =
[ 1, x, 2*x^2 - 1, 4*x^3 - 3*x, 8*x^4 - 8*x^2 + 1]
```

Chebyshev Polynomials for Numeric and Symbolic Arguments

Depending on its arguments, `chebyshevT` returns floating-point or exact symbolic results.

Find the value of the fifth-degree Chebyshev polynomial of the first kind at these points. Because these numbers are not symbolic objects, `chebyshevT` returns floating-point results.

```
chebyshevT(5, [1/6, 1/4, 1/3, 1/2, 2/3, 3/4])

ans =
    0.7428    0.9531    0.9918    0.5000   -0.4856   -0.8906
```

Find the value of the fifth-degree Chebyshev polynomial of the first kind for the same numbers converted to symbolic objects. For symbolic numbers, `chebyshevT` returns exact symbolic results.

```
chebyshevT(5, sym([1/6, 1/4, 1/3, 1/2, 2/3, 3/4]))

ans =
[ 361/486, 61/64, 241/243, 1/2, -118/243, -57/64]
```

Evaluate Chebyshev Polynomials with Floating-Point Numbers

Floating-point evaluation of Chebyshev polynomials by direct calls of `chebyshevT` is numerically stable. However, first computing the polynomial using a symbolic variable, and then substituting variable-precision values into this expression can be numerically unstable.

Find the value of the 500th-degree Chebyshev polynomial of the first kind at $1/3$ and `vpa(1/3)`. Floating-point evaluation is numerically stable.

```
chebyshevT(500, 1/3)
chebyshevT(500, vpa(1/3))
```

```
ans =
    0.9631
```

```
ans =
0.963114126817085233778571286718
```

Now, find the symbolic polynomial $T_{500} = \text{chebyshevT}(500, x)$, and substitute $x = \text{vpa}(1/3)$ into the result. This approach is numerically unstable.

```
syms x
T500 = chebyshevT(500, x);
subs(T500, x, vpa(1/3))
```

```
ans =
-3293905791337500897482813472768.0
```

Approximate the polynomial coefficients by using `vpa`, and then substitute $x = \text{sym}(1/3)$ into the result. This approach is also numerically unstable.

```
subs(vpa(T500), x, sym(1/3))
```

```
ans =
1202292431349342132757038366720.0
```

Plot Chebyshev Polynomials of the First Kind

Plot the first five Chebyshev polynomials of the first kind.

```
syms x y
fplot(chebyshevT(0:4,x))
axis([-1.5 1.5 -2 2])
grid on

ylabel('T_n(x)')
legend('T_0(x)', 'T_1(x)', 'T_2(x)', 'T_3(x)', 'T_4(x)', 'Location', 'Best')
title('Chebyshev polynomials of the first kind')
```

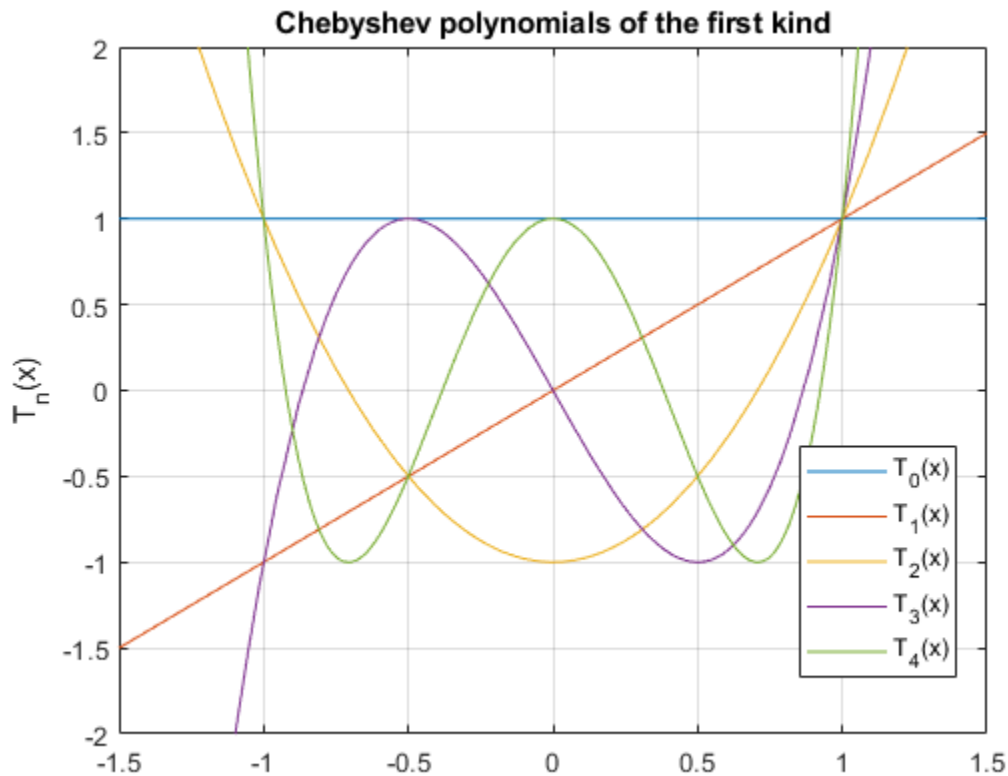

Input Arguments

n – Degree of polynomial

nonnegative integer | symbolic variable | symbolic expression | symbolic function | vector | matrix

Degree of the polynomial, specified as a nonnegative integer, symbolic variable, expression, or function, or as a vector or matrix of numbers, symbolic numbers, variables, expressions, or functions.

x – Evaluation point

number | symbolic number | symbolic variable | symbolic expression | symbolic function | vector | matrix

Evaluation point, specified as a number, symbolic number, variable, expression, or function, or as a vector or matrix of numbers, symbolic numbers, variables, expressions, or functions.

More About

Chebyshev Polynomials of the First Kind

- Chebyshev polynomials of the first kind are defined as $T_n(x) = \cos(n \cdot \arccos(x))$.

These polynomials satisfy the recursion formula

$$T(0, x) = 1, \quad T(1, x) = x, \quad T(n, x) = 2xT(n-1, x) - T(n-2, x)$$

- Chebyshev polynomials of the first kind are orthogonal on the interval $-1 \leq x \leq 1$ with respect to the weight function $w(x) = \frac{1}{\sqrt{1-x^2}}$.

$$\int_{-1}^1 \frac{T(n, x)T(m, x)}{\sqrt{1-x^2}} dx = \begin{cases} 0 & \text{if } n \neq m \\ \pi & \text{if } n = m = 0 \\ \frac{\pi}{2} & \text{if } n = m \neq 0. \end{cases}$$

- Chebyshev polynomials of the first kind are a special case of the Jacobi polynomials

$$T(n, x) = \frac{2^{2n}(n!)^2}{(2n)!} P\left(n, -\frac{1}{2}, -\frac{1}{2}, x\right)$$

and Gegenbauer polynomials

$$T(n, x) = \frac{n}{2} G(n, 0, x)$$

Tips

- `chebyshevT` returns floating-point results for numeric arguments that are not symbolic objects.
- `chebyshevT` acts element-wise on nonscalar inputs.
- At least one input argument must be a scalar or both arguments must be vectors or matrices of the same size. If one input argument is a scalar and the other one is a vector or a matrix, then `chebyshevT` expands the scalar into a vector or matrix of the same size as the other argument with all elements equal to that scalar.

References

- [1] Hochstrasser, U. W. "Orthogonal Polynomials." *Handbook of Mathematical Functions with Formulas, Graphs, and Mathematical Tables*. (M. Abramowitz and I. A. Stegun, eds.). New York: Dover, 1972.

See Also

`chebyshevU` | `gegenbauerC` | `hermiteH` | `jacobiP` | `laguerreL` | `legendreP`

Introduced in R2014b

chebyshevU

Chebyshev polynomials of the second kind

Syntax

`chebyshevU(n, x)`

Description

`chebyshevU(n, x)` represents the n th degree Chebyshev polynomial of the second kind on page 4-160 at the point x .

Examples

First Five Chebyshev Polynomials of the Second Kind

Find the first five Chebyshev polynomials of the second kind for the variable x .

```
syms x
chebyshevU([0, 1, 2, 3, 4], x)

ans =
[ 1, 2*x, 4*x^2 - 1, 8*x^3 - 4*x, 16*x^4 - 12*x^2 + 1]
```

Chebyshev Polynomials for Numeric and Symbolic Arguments

Depending on its arguments, `chebyshevU` returns floating-point or exact symbolic results.

Find the value of the fifth-degree Chebyshev polynomial of the second kind at these points. Because these numbers are not symbolic objects, `chebyshevU` returns floating-point results.

```
chebyshevU(5, [1/6, 1/3, 1/2, 2/3, 4/5])

ans =
    0.8560    0.9465    0.0000   -1.2675   -1.0982
```

Find the value of the fifth-degree Chebyshev polynomial of the second kind for the same numbers converted to symbolic objects. For symbolic numbers, `chebyshevU` returns exact symbolic results.

```
chebyshevU(5, sym([1/6, 1/4, 1/3, 1/2, 2/3, 4/5]))

ans =
[ 208/243, 33/32, 230/243, 0, -308/243, -3432/3125]
```

Evaluate Chebyshev Polynomials with Floating-Point Numbers

Floating-point evaluation of Chebyshev polynomials by direct calls of `chebyshevU` is numerically stable. However, first computing the polynomial using a symbolic variable, and then substituting variable-precision values into this expression can be numerically unstable.

Find the value of the 500th-degree Chebyshev polynomial of the second kind at $1/3$ and `vpa(1/3)`. Floating-point evaluation is numerically stable.

```
chebyshevU(500, 1/3)
chebyshevU(500, vpa(1/3))
```

```
ans =
    0.8680
```

```
ans =
0.86797529488884242798157148968078
```

Now, find the symbolic polynomial $U_{500} = \text{chebyshevU}(500, x)$, and substitute $x = \text{vpa}(1/3)$ into the result. This approach is numerically unstable.

```
syms x
U500 = chebyshevU(500, x);
subs(U500, x, vpa(1/3))
```

```
ans =
63080680195950160912110845952.0
```

Approximate the polynomial coefficients by using `vpa`, and then substitute $x = \text{sym}(1/3)$ into the result. This approach is also numerically unstable.

```
subs(vpa(U500), x, sym(1/3))
```

```
ans =
-1878009301399851172833781612544.0
```

Plot Chebyshev Polynomials of the Second Kind

Plot the first five Chebyshev polynomials of the second kind.

```
syms x y
fplot(chebyshevU(0:4, x))
axis([-1.5 1.5 -2 2])
grid on

ylabel('U_n(x)')
legend('U_0(x)', 'U_1(x)', 'U_2(x)', 'U_3(x)', 'U_4(x)', 'Location', 'Best')
title('Chebyshev polynomials of the second kind')
```

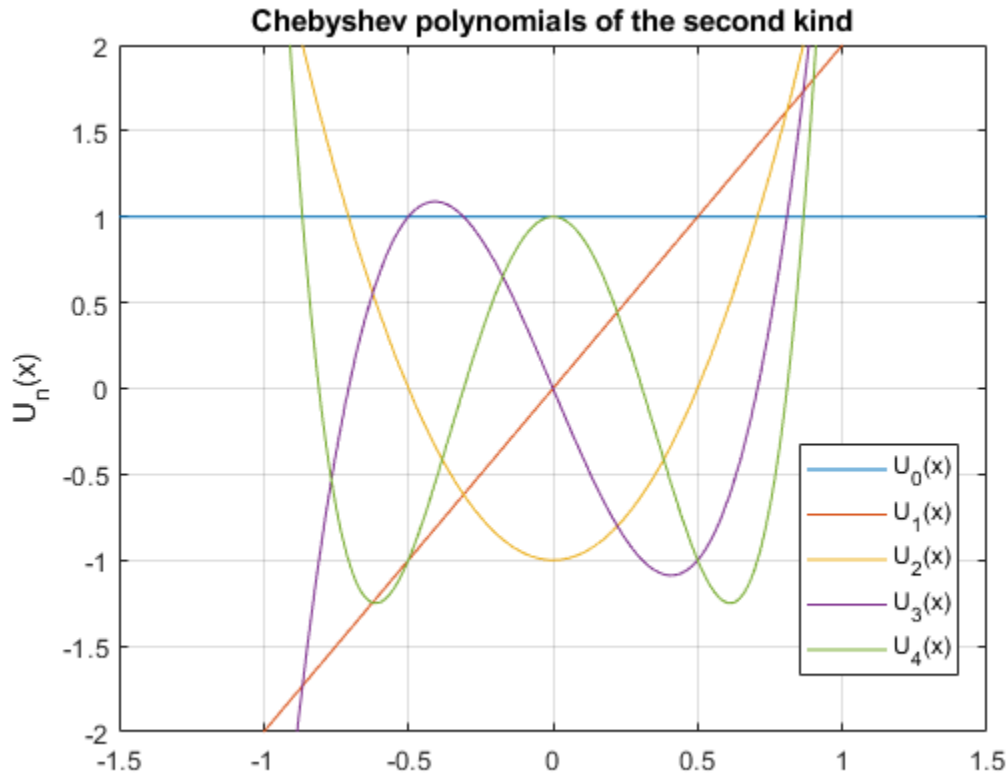

Input Arguments

n – Degree of polynomial

nonnegative integer | symbolic variable | symbolic expression | symbolic function | vector | matrix

Degree of the polynomial, specified as a nonnegative integer, symbolic variable, expression, or function, or as a vector or matrix of numbers, symbolic numbers, variables, expressions, or functions.

x – Evaluation point

number | symbolic number | symbolic variable | symbolic expression | symbolic function | vector | matrix

Evaluation point, specified as a number, symbolic number, variable, expression, or function, or as a vector or matrix of numbers, symbolic numbers, variables, expressions, or functions.

More About

Chebyshev Polynomials of the Second Kind

- Chebyshev polynomials of the second kind are defined as follows:

$$U(n, x) = \frac{\sin((n + 1)\arccos(x))}{\sin(\arccos(x))}$$

These polynomials satisfy the recursion formula

$$U(0, x) = 1, \quad U(1, x) = 2x, \quad U(n, x) = 2xU(n-1, x) - U(n-2, x)$$

- Chebyshev polynomials of the second kind are orthogonal on the interval $-1 \leq x \leq 1$ with respect to the weight function $w(x) = \sqrt{1-x^2}$.

$$\int_{-1}^1 U(n, x)U(m, x)\sqrt{1-x^2} dx = \begin{cases} 0 & \text{if } n \neq m \\ \frac{\pi}{2} & \text{if } n = m. \end{cases}$$

- Chebyshev polynomials of the second kind are a special case of the Jacobi polynomials

$$U(n, x) = \frac{2^{2n}n!(n+1)!}{(2n+1)!}P\left(n, \frac{1}{2}, \frac{1}{2}, x\right)$$

and Gegenbauer polynomials

$$U(n, x) = G(n, 1, x)$$

Tips

- `chebyshevU` returns floating-point results for numeric arguments that are not symbolic objects.
- `chebyshevU` acts element-wise on nonscalar inputs.
- At least one input argument must be a scalar or both arguments must be vectors or matrices of the same size. If one input argument is a scalar and the other one is a vector or a matrix, then `chebyshevU` expands the scalar into a vector or matrix of the same size as the other argument with all elements equal to that scalar.

References

- [1] Hochstrasser, U. W. "Orthogonal Polynomials." *Handbook of Mathematical Functions with Formulas, Graphs, and Mathematical Tables*. (M. Abramowitz and I. A. Stegun, eds.). New York: Dover, 1972.

See Also

`chebyshevT` | `gegenbauerC` | `hermiteH` | `jacobiP` | `laguerreL` | `legendreP`

Introduced in R2014b

checkUnits

Check for compatible dimensions and consistent units

Syntax

```
C = checkUnits(expr)
C = checkUnits(expr, 'Compatible')
C = checkUnits(expr, 'Consistent')
```

Description

`C = checkUnits(expr)` checks `expr` for compatible dimensions and consistent units and returns a structure containing the fields `Consistent` and `Compatible`. The fields contain logical 0 (false) or logical 1 (true) depending on the check results.

`expr` has compatible dimensions if all terms have the same dimensions, such as length or time. `expr` has consistent units if all units of the same dimension can be converted to each other with a conversion factor of 1.

`C = checkUnits(expr, 'Compatible')` only checks `expr` for compatible dimensions.

`C = checkUnits(expr, 'Consistent')` only checks `expr` for consistent units.

Examples

Check Dimensions of Units

Check the dimensions of an equation or expression. The dimensions are checked to confirm that the equation or expression is valid.

Verify the dimensions of the equation

$$A \frac{\text{m}}{\text{s}} = B \frac{\text{kg}}{\text{s}}$$

by using `checkUnits` with the option `'Compatible'`. MATLAB assumes that symbolic variables are dimensionless. The `checkUnits` function returns logical 0 (false) because the dimensions of the equation are not compatible.

```
u = symunit;
syms A B
eqn = A*u.m/u.s == B*u.kg/u.s;
checkUnits(eqn, 'Compatible')
```

```
ans =
    logical
     0
```

Replace `u.kg` with `u.m` by using `subs` and repeat the check. Because the dimensions are now compatible, `checkUnits` returns logical 1 (true).

```
eqn = subs(eqn,u.kg,u.m);
checkUnits(eqn,'Compatible')
```

```
ans =
    logical
     1
```

Check Consistency of Units

Checking units for consistency is a stronger check than compatibility. Units are consistent when all units of the same dimension can be converted to each other with a conversion factor of 1. For example, 1 Newton is consistent with 1 kg m/s^2 but not with 1 kg cm/s^2 .

Show that 1 Newton is consistent with 1 kg m/s^2 by checking `expr1` but not with 1 kg cm/s^2 by checking `expr2`.

```
u = symunit;
expr1 = 1*u.N + 1*u.kg*u.m/u.s^2;
expr2 = 1*u.N + 1*u.kg*u.cm/u.s^2;
checkUnits(expr1,'Consistent')
```

```
ans =
    logical
     1
```

```
checkUnits(expr2,'Consistent')
```

```
ans =
    logical
     0
```

Show the difference between compatibility and consistency by showing that `expr2` has compatible dimensions but not consistent units.

```
checkUnits(expr2,'Compatible')
```

```
ans =
    logical
     1
```

Check Multiple Equations or Expressions

Check multiple equations or expressions by placing them in an array. `checkUnits` returns an array whose elements correspond to the elements of the input.

Check multiple equations for compatible dimensions. `checkUnits` returns `[1 0]`, meaning that the first equation has compatible dimensions while the second equation does not.

```
u = symunit;
syms x y z
eqn1 = x*u.m == y*u.m^2/(z*u.m);
eqn2 = x*u.m + y*u.s == z*u.m;
eqns = [eqn1 eqn2];
compatible = checkUnits(eqns,'Compatible')
```

```
compatible =
    1×2 logical array
     1     0
```

Check Dimensions and Consistency of Units

Check for both compatible dimensions and consistent units of the equation or expression by using `checkUnits`.

Define the equations for x- and y-displacement of a moving projectile. Check their units for compatibility and consistency.

```
u = symunit;
g = 9.81*u.cm/u.s^2;
v = 10*u.m/u.s^2;
syms theta x(t) y(t)
x(t) = v*cos(theta)*t;
y(t) = v*sin(theta)*t + (-g*t^2)/2;
S = checkUnits([x y])
```

```
S =
  struct with fields:

    Consistent: [1 0]
    Compatible: [1 1]
```

The second equation has compatible dimensions but inconsistent units. This inconsistency is because `g` incorrectly uses `cm` instead of `m`. Redefine `g` and check the equations again. The second equation now has consistent units.

```
g = 9.81*u.m/u.s^2;
y(t) = v*sin(theta)*t + (-g*t^2)/2;
S = checkUnits([x y])
```

```
S =
  struct with fields:

    Consistent: [1 1]
    Compatible: [1 1]
```

Input Arguments

expr — Input expression

symbolic expression | symbolic equation | symbolic function | symbolic vector | symbolic matrix | symbolic multidimensional array

Input expression, specified as a symbolic expression, equation, function, vector, matrix, or multidimensional array.

See Also

`findUnits` | `isUnit` | `newUnit` | `separateUnits` | `str2symunit` | `symunit` | `symunit2str` | `unitConversionFactor`

Topics

“Units of Measurement Tutorial” on page 2-19
 “Unit Conversions and Unit Systems” on page 2-39
 “Units and Unit Systems List” on page 2-25

Introduced in R2017a

children

Subexpressions or terms of symbolic expression

Syntax

```
children(expr)
children(A)
```

Description

`children(expr)` returns a vector containing the child subexpressions of the symbolic expression `expr`. For example, the child subexpressions of a sum are its terms.

`children(A)` returns a cell array containing the child subexpressions of each expression in `A`.

Examples

Find Child Subexpressions of Symbolic Expression

Find the child subexpressions of this expression. Child subexpressions of a sum are its terms.

```
syms x y
children(x^2 + x*y + y^2)
```

```
ans =
 [ x*y, x^2, y^2]
```

Find the child subexpressions of this expression. This expression is also a sum, only some terms of that sum are negative.

```
children(x^2 - x*y - y^2)
```

```
ans =
 [ -x*y, x^2, -y^2]
```

The child subexpression of a variable is the variable itself:

```
children(x)
```

```
ans =
 x
```

Find Child Subexpressions of Equation

Find the child subexpressions of this equation. The child subexpressions of an equation are the left and right sides of that equation.

```
syms x y
children(x^2 + x*y == y^2 + 1)
```

```
ans =
 [ x^2 + y*x, y^2 + 1]
```

Find the child subexpressions of this inequality. The child subexpressions of an inequality are the left and right sides of that inequality.

```
children(sin(x) < cos(x))
```

```
ans =  
[ sin(x), cos(x)]
```

Find Child Subexpressions of Elements of Matrix

Call the `children` function for this matrix. The result is the cell array containing the child subexpressions of each element of the matrix.

```
syms x y  
s = children([x + y, sin(x)*cos(y); x^3 - y^3, exp(x*y^2)])
```

```
s =  
 2x2 cell array  
  {1x2 sym}   {1x2 sym}  
  {1x2 sym}   {1x1 sym}
```

To access the contents of cells in the cell array, use braces:

```
s{1:4}
```

```
ans =  
[ x, y]
```

```
ans =  
[ x^3, -y^3]
```

```
ans =  
[ cos(y), sin(x)]
```

```
ans =  
x*y^2
```

Input Arguments

expr — Input

symbolic number | symbolic variable | symbolic function | symbolic expression

Input, specified as a symbolic number, variable, function, or expression.

A — Input

symbolic array

Input, specified as a symbolic array.

See Also

`coeffs` | `lhs` | `numden` | `rhs` | `subs`

Topics

“Create Symbolic Numbers, Variables, and Expressions” on page 1-3

Introduced in R2012a

chol

Cholesky factorization

Syntax

```
T = chol(A)
[T,p] = chol(A)
[T,p,S] = chol(A)
[T,p,s] = chol(A,'vector')
_____ = chol(A,'lower')
_____ = chol(A,'nocheck')
_____ = chol(A,'real')
_____ = chol(A,'lower','nocheck','real')
[T,p,s] = chol(A,'lower','vector','nocheck','real')
```

Description

`T = chol(A)` returns an upper triangular matrix T , such that $T'*T = A$. A must be a Hermitian positive definite matrix on page 4-174. Otherwise, this syntax throws an error.

`[T,p] = chol(A)` computes the Cholesky factorization on page 4-174 of A . This syntax does not error if A is not a Hermitian positive definite matrix. If A is a Hermitian positive definite matrix, then p is 0. Otherwise, T is `sym([])`, and p is a positive integer (typically, $p = 1$).

`[T,p,S] = chol(A)` returns a permutation matrix S , such that $T'*T = S'*A*S$, and the value $p = 0$ if matrix A is Hermitian positive definite. Otherwise, it returns a positive integer p and an empty object $S = \text{sym}([])$.

`[T,p,s] = chol(A,'vector')` returns the permutation information as a vector s , such that $A(s,s) = T'*T$. If A is not recognized as a Hermitian positive definite matrix, then p is a positive integer and $s = \text{sym}([])$.

`_____ = chol(A,'lower')` returns a lower triangular matrix T , such that $T*T' = A$.

`_____ = chol(A,'nocheck')` skips checking whether matrix A is Hermitian positive definite. 'nocheck' lets you compute Cholesky factorization of a matrix that contains symbolic parameters without setting additional assumptions on those parameters.

`_____ = chol(A,'real')` computes the Cholesky factorization of A using real arithmetic. In this case, `chol` computes a symmetric factorization $A = T.'*T$ instead of a Hermitian factorization $A = T'*T$. This approach is based on the fact that if A is real and symmetric, then $T'*T = T.'*T$. Use 'real' to avoid complex conjugates in the result.

`_____ = chol(A,'lower','nocheck','real')` computes the Cholesky factorization of A with one or more of these optional arguments: 'lower', 'nocheck', and 'real'. These optional arguments can appear in any order.

`[T,p,s] = chol(A,'lower','vector','nocheck','real')` computes the Cholesky factorization of A and returns the permutation information as a vector s . You can use one or more of these optional arguments: 'lower', 'nocheck', and 'real'. These optional arguments can appear in any order.

Examples

Compute Cholesky Factorization of Numeric and Symbolic Matrices

Compute the Cholesky factorization of the 3-by-3 Hilbert matrix. Because these numbers are not symbolic objects, you get floating-point results.

```
chol(hilb(3))

ans =
    1.0000    0.5000    0.3333
         0    0.2887    0.2887
         0         0    0.0745
```

Now convert this matrix to a symbolic object, and compute the Cholesky factorization:

```
chol(sym(hilb(3)))

ans =
 [ 1,      1/2,      1/3]
 [ 0, 3^(1/2)/6, 3^(1/2)/6]
 [ 0,      0, 5^(1/2)/30]
```

Return Lower Triangular Matrix

Compute the Cholesky factorization of the 3-by-3 Pascal matrix returning a lower triangular matrix as a result:

```
chol(sym(pascal(3)), 'lower')

ans =
 [ 1, 0, 0]
 [ 1, 1, 0]
 [ 1, 2, 1]
```

If Input is not Hermitian Positive Definite

Try to compute the Cholesky factorization of this matrix. Because this matrix is not Hermitian positive definite, `chol` used without output arguments or with one output argument throws an error:

```
A = sym([1 1 1; 1 2 3; 1 3 5]);
T = chol(A)
```

```
Error using sym/chol (line 132)
Cannot prove that input matrix is Hermitian positive definite.
Define a Hermitian positive definite matrix by setting
appropriate assumptions on matrix components, or use 'nocheck'
to skip checking whether the matrix is Hermitian positive definite.
```

To suppress the error, use two output arguments, `T` and `p`. If the matrix is not recognized as Hermitian positive definite, then this syntax assigns an empty symbolic object to `T` and the value 1 to `p`:

```
[T,p] = chol(A)

T =
 [ empty sym ]
```



```
p =
     1
```

For a Hermitian positive definite matrix, p is 0:

```
[T,p] = chol(sym(pascal(3)))
```

```
T =
 [ 1, 1, 1]
 [ 0, 1, 2]
 [ 0, 0, 1]
p =
     0
```

Alternatively, 'nocheck' lets you skip checking whether A is a Hermitian positive definite matrix. Thus, this flag lets you compute the Cholesky factorization of a symbolic matrix without setting additional assumptions on its components to make it Hermitian positive definite:

```
syms a
A = [a 0; 0 a];
chol(A,'nocheck')

ans =
 [ a^(1/2),      0]
 [      0, a^(1/2)]
```

If you use 'nocheck' for computing the Cholesky factorization of a matrix that is not Hermitian positive definite, chol can return a matrix T for which the identity $T'*T = A$ does not hold. To make isAlways return logical 0 (false) for undecidable conditions, set Unknown to false.

```
T = chol(sym([1 1; 2 1]), 'nocheck')

T =
 [ 1,      2]
 [ 0, 3^(1/2)*1i]

isAlways(A == T'*T,'Unknown','false')

ans =
 2x2 logical array
     0     0
     0     0
```

Return Permutation Matrix

Compute the Cholesky factorization of the 3-by-3 inverse Hilbert matrix returning the permutation matrix:

```
A = sym(invhilb(3));
[T, p, S] = chol(A)

T =
 [ 3,      -12,      10]
 [ 0, 4*3^(1/2), -5*3^(1/2)]
 [ 0,      0,      5^(1/2)]

p =
     0
```

```
S =
     1     0     0
     0     1     0
     0     0     1
```

Return Permutation Information as Vector

Compute the Cholesky factorization of the 3-by-3 inverse Hilbert matrix returning the permutation information as a vector:

```
A = sym(invhilb(3));
[T, p, S] = chol(A, 'vector')
```

```
T =
 [ 3,          -12,          10]
 [ 0, 4*3^(1/2), -5*3^(1/2)]
 [ 0,          0,    5^(1/2)]
p =
     0
S =
     1     2     3
```

Use Assumptions to Make Matrix Hermitian Positive Definite

Compute the Cholesky factorization of matrix *A* containing symbolic parameters. Without additional assumptions on the parameter *a*, this matrix is not Hermitian. To make `isAlways` return logical 0 (`false`) for undecidable conditions, set `Unknown` to `false`.

```
syms a
A = [a 0; 0 a];
isAlways(A == A', 'Unknown', 'false')
```

```
ans =
 2x2 logical array
     0     1
     1     0
```

By setting assumptions on *a* and *b*, you can define *A* to be Hermitian positive definite. Therefore, you can compute the Cholesky factorization of *A*:

```
assume(a > 0)
chol(A)
```

```
ans =
 [ a^(1/2),          0]
 [          0, a^(1/2)]
```

For further computations, remove the assumptions on *a* by recreating it using `syms`:

```
syms a
```

Return Real Result Without Complex Conjugates

Compute the Cholesky factorization of this matrix. To skip checking whether it is Hermitian positive definite, use `'nocheck'`. By default, `chol` computes a Hermitian factorization $A = T^*T$. Thus, the result contains complex conjugates.

```

syms a b
A = [a b; b a];
T = chol(A, 'nocheck')

T =
[ a^(1/2), conj(b)/conj(a^(1/2))]
[ 0, (a*abs(a) - abs(b)^2)^(1/2)/abs(a)^(1/2)]

```

To avoid complex conjugates in the result, use 'real':

```

T = chol(A, 'nocheck', 'real')

T =
[ a^(1/2), b/a^(1/2)]
[ 0, ((a^2 - b^2)/a)^(1/2)]

```

When you use this flag, `chol` computes a symmetric factorization $A = T.'*T$ instead of a Hermitian factorization $A = T'*T$. To make `isAlways` return logical 0 (false) for undecidable conditions, set `Unknown` to `false`.

```

isAlways(A == T.'*T)

ans =
  2x2 logical array
   1   1
   1   1

isAlways(A == T'*T, 'Unknown', 'false')

ans =
  2x2 logical array
   0   0
   0   0

```

Input Arguments

A — Input

number | vector | matrix | multidimensional array | symbolic number | symbolic array | symbolic function | symbolic expression

Input, specified as a number, vector, matrix, or array, or a symbolic number, variable, array, function, or expression.

Output Arguments

T — Upper triangular matrix

symbolic matrix

Upper triangular matrix, returned as a symbolic matrix such that $T.'*T = A$. If T is a lower triangular matrix, then $T*T' = A$.

p — Output

symbolic number

Flag, returned as a symbolic number. Value 0 if A is Hermitian positive definite or if you use 'nocheck'.

If `chol` does not identify A as a Hermitian positive definite matrix, then p is a positive integer. R is an upper triangular matrix of order $q = p - 1$, such that $R' * R = A(1:q, 1:q)$.

S — Permutation matrix

symbolic matrix

Permutation matrix returned as a symbolic matrix.

s — Permutation vector

symbolic vector

Permutation vector returned as a symbolic vector.

Limitations

Matrix computations involving many symbolic variables can be slow. To increase the computational speed, reduce the number of symbolic variables by substituting the given values for some variables.

More About

Hermitian Positive Definite Matrix

A square complex matrix A is Hermitian positive definite if $v' * A * v$ is real and positive for all nonzero complex vectors v , where v' is the conjugate transpose (Hermitian transpose) of v .

Cholesky Factorization of a Matrix

The Cholesky factorization of a Hermitian positive definite n -by- n matrix A is defined by an upper or lower triangular matrix with positive entries on the main diagonal. The Cholesky factorization of matrix A can be defined as $T' * T = A$, where T is an upper triangular matrix. Here T' is the conjugate transpose of T . The Cholesky factorization also can be defined as $T * T' = A$, where T is a lower triangular matrix. T is called the Cholesky factor of A .

Tips

- Calling `chol` for numeric arguments that are not symbolic objects invokes the MATLAB `chol` function.
- If you use `'nocheck'`, then the identities $T' * T = A$ (for an upper triangular matrix T) and $T * T' = A$ (for a lower triangular matrix T) are not guaranteed to hold.
- If you use `'real'`, then the identities $T' * T = A$ (for an upper triangular matrix T) and $T * T' = A$ (for a lower triangular matrix T) are only guaranteed to hold for a real symmetric positive definite A .
- To use `'vector'`, you must specify three output arguments. Other flags do not require a particular number of output arguments.
- If you use `'matrix'` instead of `'vector'`, then `chol` returns permutation matrices, as it does by default.
- If you use `'upper'` instead of `'lower'`, then `chol` returns an upper triangular matrix, as it does by default.
- If A is not a Hermitian positive definite matrix, then the syntaxes containing the argument p typically return $p = 1$ and an empty symbolic object T .

- To check whether a matrix is Hermitian, use the operator `'` (or its functional form `ctranspose`). Matrix A is Hermitian if and only if $A' = A$, where A' is the conjugate transpose of A .

See Also

`chol` | `ctranspose` | `eig` | `isAlways` | `lu` | `qr` | `svd` | `transpose` | `vpa`

Introduced in R2013a

coeffs

Coefficients of polynomial

Syntax

```
C = coeffs(p)
C = coeffs(p,var)
C = coeffs(p,vars)
[C,T] = coeffs( ___ )
___ = coeffs( ___, 'All' )
```

Description

`C = coeffs(p)` returns coefficients of the polynomial `p` with respect to all variables determined in `p` by `symvar`.

`C = coeffs(p,var)` returns coefficients of the polynomial `p` with respect to the variable `var`.

`C = coeffs(p,vars)` returns coefficients of the multivariate polynomial `p` with respect to the variables `vars`.

`[C,T] = coeffs(___)` returns the coefficient `C` and the corresponding terms `T` of the polynomial `p`.

`___ = coeffs(___, 'All')` returns all coefficients, including coefficients that are 0. For example, `coeffs(2*x^2, 'All')` returns `[2, 0, 0]` instead of `2`.

Examples

Coefficients of Univariate Polynomial

Find the coefficients of this univariate polynomial. The coefficients are ordered from the lowest degree to the highest degree.

```
syms x
c = coeffs(16*x^2 + 19*x + 11)
```

```
c =
[ 11, 19, 16]
```

Reverse the ordering of coefficients by using `fliplr`.

```
c = fliplr(c)
```

```
c =
[ 16, 19, 11]
```

Coefficients of Multivariate Polynomial with Respect to Particular Variable

Find the coefficients of this polynomial with respect to variable `x` and variable `y`.

```
syms x y
cx = coeffs(x^3 + 2*x^2*y + 3*x*y^2 + 4*y^3, x)
cy = coeffs(x^3 + 2*x^2*y + 3*x*y^2 + 4*y^3, y)
```

```
cx =
[ 4*y^3, 3*y^2, 2*y, 1]
```

```
cy =
[ x^3, 2*x^2, 3*x, 4]
```

Coefficients of Multivariate Polynomial with Respect to Two Variables

Find the coefficients of this polynomial with respect to both variables x and y .

```
syms x y
cxy = coeffs(x^3 + 2*x^2*y + 3*x*y^2 + 4*y^3, [x y])
cyx = coeffs(x^3 + 2*x^2*y + 3*x*y^2 + 4*y^3, [y x])
```

```
cxy =
[ 4, 3, 2, 1]
```

```
cyx =
[ 1, 2, 3, 4]
```

Coefficients and Corresponding Terms of Univariate Polynomial

Find the coefficients and the corresponding terms of this univariate polynomial. When two outputs are provided, the coefficients are ordered from the highest degree to the lowest degree.

```
syms x
[c,t] = coeffs(16*x^2 + 19*x + 11)
```

```
c =
[ 16, 19, 11]
```

```
t =
[ x^2, x, 1]
```

Coefficients and Corresponding Terms of Multivariate Polynomial

Find the coefficients and the corresponding terms of this polynomial with respect to variable x and variable y .

```
syms x y
[cx,tx] = coeffs(x^3 + 2*x^2*y + 3*x*y^2 + 4*y^3, x)
[cy,ty] = coeffs(x^3 + 2*x^2*y + 3*x*y^2 + 4*y^3, y)
```

```
cx =
[ 1, 2*y, 3*y^2, 4*y^3]
```

```
tx =
[ x^3, x^2, x, 1]
```

```
cy =
[ 4, 3*x, 2*x^2, x^3]
```

```
ty =
[ y^3, y^2, y, 1]
```

Find the coefficients of this polynomial with respect to both variables x and y .

```
syms x y
[cxy, txy] = coeffs(x^3 + 2*x^2*y + 3*x*y^2 + 4*y^3, [x,y])
[cyx, tyx] = coeffs(x^3 + 2*x^2*y + 3*x*y^2 + 4*y^3, [y,x])

cxy =
[ 1, 2, 3, 4]

txy =
[ x^3, x^2*y, x*y^2, y^3]

cyx =
[ 4, 3, 2, 1]

tyx =
[ y^3, x*y^2, x^2*y, x^3]
```

All Coefficients of Polynomial

Find all coefficients of a polynomial, including coefficients that are 0, by specifying the option 'All'. The returned coefficients are ordered from the highest degree to the lowest degree.

Find all coefficients of $3x^2$.

```
syms x
c = coeffs(3*x^2, 'All')

c =
[ 3, 0, 0]
```

If you find coefficients with respect to multiple variables and specify 'All', then `coeffs` returns coefficients for all combinations of the variables.

Find all coefficients and corresponding terms of $ax^2 + by$.

```
syms a b y
[cxy, txy] = coeffs(a*x^2 + b*y, [y x], 'All')

cxy =
[ 0, 0, b]
[ a, 0, 0]
txy =
[ x^2*y, x*y, y]
[ x^2, x, 1]
```

Input Arguments

p — Polynomial

symbolic expression | symbolic function

Polynomial, specified as a symbolic expression or function.

var — Polynomial variable

symbolic variable

Polynomial variable, specified as a symbolic variable.

vars – Polynomial variables

vector of symbolic variables

Polynomial variables, specified as a vector of symbolic variables.

Output Arguments**C – Coefficients of polynomial**

symbolic number | symbolic variable | symbolic expression | symbolic vector | symbolic matrix | symbolic multidimensional array

Coefficients of polynomial, returned as a symbolic number, variable, expression, vector, matrix, or multidimensional array. If there is only one coefficient and one corresponding term, then C is returned as a scalar.

T – Terms of polynomial

symbolic number | symbolic variable | symbolic expression | symbolic vector | symbolic matrix | symbolic multidimensional array

Terms of polynomial, returned as a symbolic number, variable, expression, vector, matrix, or multidimensional array. If there is only one coefficient and one corresponding term, then T is returned as a scalar.

See Also

`poly2sym` | `sym2poly`

Introduced before R2006a

collect

Collect coefficients

Syntax

```
collect(P)
collect(P,expr)
```

Description

`collect(P)` collects coefficients in P of the powers of the default variable of P . The default variable is found by `symvar`.

`collect(P,expr)` collects coefficients in P of the powers of the symbolic expression `expr`. If P is a vector or matrix, then `collect` acts element-wise on P . If `expr` is a vector, then `collect` finds coefficients in terms of all expressions in `expr`.

Examples

Collect Coefficients of Powers of Default Variable

Collect the coefficients of a symbolic expression.

```
syms x
coeffs = collect((exp(x) + x)*(x + 2))

coeffs =
x^2 + (exp(x) + 2)*x + 2*exp(x)
```

Because you did not specify the variable, `collect` uses the default variable defined by `symvar`. For this expression, the default variable is x .

```
symvar((exp(x) + x)*(x + 2), 1)

ans =
x
```

Collect Coefficients of Powers of a Particular Variable

Collect coefficients of a particular variable by specifying the variable as the second argument to `collect`.

Collect coefficients of an expression in powers of x , and then in powers of y .

```
syms x y
coeffs_x = collect(x^2*y + y*x - x^2 - 2*x, x)
coeffs_y = collect(x^2*y + y*x - x^2 - 2*x, y)

coeffs_x =
(y - 1)*x^2 + (y - 2)*x
coeffs_y =
(x^2 + x)*y - x^2 - 2*x
```

Collect coefficients in powers of both x and y by specifying the second argument as a vector of variables.

```
syms a b
coeffs_xy = collect(a^2*x*y + a*b*x^2 + a*x*y + x^2, [x y])

coeffs_xy =
(a*b + 1)*x^2 + (a^2 + a)*x*y
```

Collect Coefficients in Terms of i and π

Collect coefficients of an expression in terms of i , and then in terms of π .

```
syms x y
coeffs_i = collect(2*x*i - 3*i*y, i)
coeffs_pi = collect(x*pi*(pi - y) + x*(pi + i) + 3*pi*y, pi)

coeffs_i =
(2*x - 3*y)*1i
coeffs_pi =
x*pi^2 + (x + 3*y - x*y)*pi + x*1i
```

Collect Coefficients of Symbolic Expressions and Functions

Collect coefficients of expressions and functions by specifying the second argument as an expression or function. Collect coefficients of multiple expressions or functions by using vector input.

Expand $\sin(x + 3*y)$ and collect coefficients of $\cos(y)$, and then of both $\sin(x)$ and $\sin(y)$.

```
syms x y
f = expand(sin(x + 3*y));
coeffs_cosy = collect(f, cos(y))

coeffs_cosy =
4*sin(x)*cos(y)^3 + 4*cos(x)*sin(y)*cos(y)^2 + (-3*sin(x))*cos(y) - cos(x)*sin(y)

coeffs_sinxsiny = collect(f, [sin(x) sin(y)])

coeffs_sinxsiny =
(4*cos(y)^3 - 3*cos(y))*sin(x) + (4*cos(x)*cos(y)^2 - cos(x))*sin(y)
```

Collect coefficients of the symbolic function $y(x)$ in a symbolic expression.

```
syms y(x)
f = y^2*x + y*x^2 + y*sin(x) + x*y;
coeffs_y = collect(f, y)

coeffs_y(x) =
x*y(x)^2 + (x + sin(x) + x^2)*y(x)
```

Collect Coefficients for Each Element of Matrix

Call `collect` on a matrix. `collect` acts element-wise on the matrix.

```
syms x y
collect([(x + 1)*(y + 1), x^2 + x*(x - y); 2*x*y - x, x*y + x/y], x)

ans =
[ (y + 1)*x + y + 1, 2*x^2 - y*x]
[ (2*y - 1)*x, (y + 1/y)*x]
```

Collect Coefficients of Function Calls

Collect coefficients of calls to a particular function by specifying the function name as the second argument. Collect coefficients of function calls with respect to multiple functions by specifying the multiple functions as a cell array of character vectors.

Collect coefficients of calls to the `sin` function in `F`, where `F` contains multiple calls to different functions.

```
syms a b c d e f x
F = a*sin(2*x) + b*sin(2*x) + c*cos(x) + d*cos(x) + e*sin(3*x) + f*sin(3*x);
collect(F, 'sin')
```

```
ans =
(a + b)*sin(2*x) + (e + f)*sin(3*x) + c*cos(x) + d*cos(x)
```

Collect coefficients of calls to both the `sin` and `cos` functions in `F`.

```
collect(F, {'sin' 'cos'})
```

```
ans =
(c + d)*cos(x) + (a + b)*sin(2*x) + (e + f)*sin(3*x)
```

Input Arguments

P — Input expression

symbolic expression | symbolic function | symbolic vector | symbolic matrix

Input expression, specified as a symbolic expression, function, vector, or matrix.

expr — Expression in terms of which you collect coefficients

symbolic number | symbolic variable | symbolic expression | symbolic function | symbolic vector | character vector | cell array of character vectors

Expression in terms of which you collect the coefficients, specified as a symbolic number, variable, expression, function, or vector; a character vector; a cell array of character vectors.

Example: `i`, `pi`, `x`, `sin(x)`, `y(x)`, `[sin(x) cos(y)]`, `{'sin' 'cos'}`.

See Also

`combine` | `expand` | `factor` | `horner` | `numden` | `rewrite` | `simplify` | `simplifyFraction` | `symvar`

Topics

“Choose Function to Rearrange Expression” on page 2-104

Introduced before R2006a

colon, :

Create symbolic vectors, array subscripting, and for-loop iterators

Syntax

```
m:n
m:d:n
x:x+r
x:d:x+r
```

Description

$m:n$ returns a symbolic vector of values $[m, m+1, \dots, n]$, where m and n are symbolic constants. If n is not an increment of m , then the last value of the vector stops before n . This behavior holds for all syntaxes.

$m:d:n$ returns a symbolic vector of values $[m, m+d, \dots, n]$, where d is a rational number.

$x:x+r$ returns a symbolic vector of values $[x, x+1, \dots, x+r]$, where x is a symbolic variable and r is a rational number.

$x:d:x+r$ returns a symbolic vector of values $[x, x+d, \dots, x+r]$, where d and r are rational numbers.

Examples

Create Numeric and Symbolic Arrays

Use the colon operator to create numeric and symbolic arrays. Because these inputs are not symbolic objects, you receive floating-point results.

```
1/2:7/2
```

```
ans =
    0.5000    1.5000    2.5000    3.5000
```

To obtain symbolic results, convert the inputs to symbolic objects.

```
sym(1/2):sym(7/2)
```

```
ans =
[ 1/2, 3/2, 5/2, 7/2]
```

Specify the increment used.

```
sym(1/2):2/3:sym(7/2)
```

```
ans =
[ 1/2, 7/6, 11/6, 5/2, 19/6]
```

Obtain Increments of Symbolic Variable

```
syms x
x:x+2

ans =
[ x, x + 1, x + 2]
```

Specify the increment used.

```
syms x
x:3/7:x+2

ans =
[ x, x + 3/7, x + 6/7, x + 9/7, x + 12/7]
```

Obtain increments between x and $2*x$ in intervals of $x/3$.

```
syms x
x:x/3:2*x

ans =
[ x, (4*x)/3, (5*x)/3, 2*x]
```

Find Product of Harmonic Series

Find the product of the first four terms of the harmonic series.

```
syms x
p = sym(1);
for i = x:x+3
    p = p*1/i;
end
p

p =
1/(x*(x + 1)*(x + 2)*(x + 3))
```

Use `expand` to obtain the full polynomial.

```
expand(p)

ans =
1/(x^4 + 6*x^3 + 11*x^2 + 6*x)
```

Use `subs` to replace x with 1 and find the product in fractions.

```
p = subs(p,x,1)

p =
1/24
```

Use `vpa` to return the result as a floating-point value.

```
vpa(p)

ans =
0.041666666666666666666666666666667
```

You can also perform the described operations in a single line of code.

```
vpa(subs( expand(prod(1./(x:x+3))) ,x,1))
```

```
ans =
0.041666666666666666666666666666667
```

Input Arguments

m – Input

symbolic constant

Input, specified as a symbolic constant.

n – Input

symbolic constant

Input, specified as a symbolic constant.

x – Input

symbolic variable

Input, specified as a symbolic variable.

r – Upper bound on vector values

symbolic rational

Upper bound on vector values, specified as a symbolic rational. For example, $x:x+2$ returns $[x, x + 1, x + 2]$.

d – Increment in vector values

symbolic rational

Increment in vector values, specified as a symbolic rational. For example, $x:1/2:x+2$ returns $[x, x + 1/2, x + 1, x + 3/2, x + 2]$.

See Also

reshape

Introduced before R2006a

colspace

Basis for column space of matrix

Syntax

```
colspace(A)
```

Description

`colspace(A)` returns a symbolic matrix whose columns form a basis for the column space of the symbolic matrix `A`.

Examples

Compute Basis for Column Space of Symbolic Matrix

Compute the basis for the column space of a symbolic matrix.

```
A = sym([2 0;3 4;0 5]);  
B = colspace(A)
```

```
B =  
[      1,      0]  
[      0,      1]  
[ -15/8, 5/4]
```

Input Arguments

A — Input

symbolic matrix

Input, specified as a symbolic matrix.

See Also

`null`

Introduced before R2006a

combine

Combine terms of identical algebraic structure

Syntax

```
Y = combine(S)
Y = combine(S,T)
Y = combine( ____, 'IgnoreAnalyticConstraints', true)
```

Description

`Y = combine(S)` rewrites products of powers in the expression `S` as a single power.

`Y = combine(S,T)` combines multiple calls to the target function `T` in the expression `S`. Use `combine` to implement the inverse functionality of `expand` with respect to the majority of the applied rules.

`Y = combine(____, 'IgnoreAnalyticConstraints', true)` simplifies the output by applying common mathematical identities, such as $\log(a) + \log(b) = \log(a*b)$. These identities might not be valid for all values of the variables, but applying them can return simpler results.

Examples

Powers of the Same Base

Combine powers of the same base.

```
syms x y z
combine(x^y*x^z)
```

```
ans =
x^(y + z)
```

Combine powers of numeric arguments. To prevent MATLAB from evaluating the expression, use `sym` to convert at least one numeric argument into a symbolic value.

```
syms x y
combine(x^(3)*x^y*x^exp(sym(1)))
```

```
ans =
x^(y + exp(1) + 3)
```

Here, `sym` converts 1 into a symbolic value, preventing MATLAB from evaluating the expression e^1 .

Powers of the Same Exponent

Combine powers with the same exponents in certain cases.

```
combine(sqrt(sym(2))*sqrt(3))
```

```
ans =
6^(1/2)
```

`combine` does not usually combine the powers because the internal simplifier applies the same rules in the opposite direction to expand the result.

```
syms x y
combine(y^5*x^5)

ans =
x^5*y^5
```

Terms with Logarithms

Combine terms with logarithms by specifying the target argument as `log`. For real positive numbers, the logarithm of a product equals the sum of the logarithms of its factors.

```
S = log(sym(2)) + log(sym(3));
combine(S, 'log')

ans =
log(6)
```

Try combining $\log(a) + \log(b)$. Because a and b are assumed to be complex numbers by default, the rule does not hold and `combine` does not combine the terms.

```
syms a b
S = log(a) + log(b);
combine(S, 'log')

ans =
log(a) + log(b)
```

Apply the rule by setting assumptions such that a and b satisfy the conditions for the rule.

```
assume(a > 0)
assume(b > 0)
S = log(a) + log(b);
combine(S, 'log')

ans =
log(a*b)
```

For future computations, clear the assumptions set on variables a and b by recreating them using `syms`.

```
syms a b
```

Alternatively, apply the rule by ignoring analytic constraints using `'IgnoreAnalyticConstraints'`.

```
syms a b
S = log(a) + log(b);
combine(S, 'log', 'IgnoreAnalyticConstraints', true)

ans =
log(a*b)
```

Terms with Sine and Cosine Function Calls

Rewrite products of sine and cosine functions as a sum of the functions by setting the target argument to `sincos`.

```
syms a b
combine(sin(a)*cos(b) + sin(b)^2, 'sincos')
```

```
ans =
sin(a + b)/2 - cos(2*b)/2 + sin(a - b)/2 + 1/2
```

Rewrite sums of sine and cosine functions by setting the target argument to `sincos`.

```
combine(cos(a) + sin(a), 'sincos')
```

```
ans =
2^(1/2)*cos(a - pi/4)
```

Rewrite a cosine squared function by setting the target argument to `sincos`.

```
combine(cos(a)^2, 'sincos')
```

```
ans =
cos(2*a)/2 + 1/2
```

`combine` does not rewrite powers of sine or cosine functions with negative integer exponents.

```
syms a b
combine(sin(b)^(-2)*cos(b)^(-2), 'sincos')
```

```
ans =
1/(cos(b)^2*sin(b)^2)
```

Exponential Terms

Combine terms with exponents by specifying the target argument as `exp`.

```
combine(exp(sym(3))*exp(sym(2)), 'exp')
```

```
ans =
exp(5)
```

```
syms a
combine(exp(a)^3, 'exp')
```

```
ans =
exp(3*a)
```

Terms with Integrals

Combine terms with integrals by specifying the target argument as `int`.

```
syms a f(x) g(x)
combine(int(f(x),x)+int(g(x),x), 'int')
combine(a*int(f(x),x), 'int')
```

```
ans =
int(f(x) + g(x), x)
ans =
int(a*f(x), x)
```

Combine integrals with the same limits.

```
syms a b h(z)
combine(int(f(x),x,a,b)+int(h(z),z,a,b), 'int')
```

```
ans =  
int(f(x) + h(x), x, a, b)
```

Terms with Inverse Tangent Function Calls

Combine two calls to the inverse tangent function by specifying the target argument as `atan`.

```
syms a b  
assume(-1 < a < 1)  
assume(-1 < b < 1)  
combine(atan(a) + atan(b), 'atan')
```

```
ans =  
-atan((a + b)/(a*b - 1))
```

Combine two calls to the inverse tangent function. `combine` simplifies the expression to a symbolic value if possible.

```
assume(a > 0)  
combine(atan(a) + atan(1/a), 'atan')
```

```
ans =  
pi/2
```

For further computations, clear the assumptions:

```
syms a b
```

Terms with Calls to Gamma Function

Combine multiple gamma functions by specifying the target as `gamma`.

```
syms x  
combine(gamma(x)*gamma(1-x), 'gamma')
```

```
ans =  
-pi/sin(pi*(x - 1))
```

`combine` simplifies quotients of gamma functions to rational expressions.

Multiple Input Expressions in One Call

Evaluate multiple expressions in one function call by using a symbolic matrix as the input parameter.

```
S = [sqrt(sym(2))*sqrt(5), sqrt(2)*sqrt(sym(11))];  
combine(S)
```

```
ans =  
[ 10^(1/2), 22^(1/2)]
```

Input Arguments

S — Input expression

symbolic expression | symbolic vector | symbolic matrix | symbolic function

Input expression, specified as a symbolic expression, function, or as a vector or matrix of symbolic expressions or functions.

combine works recursively on subexpressions of S.

If S is a symbolic matrix, combine is applied to all elements of the matrix.

T – Target function

'atan' | 'exp' | 'gamma' | 'int' | 'log' | 'sincos' | 'sinhcosh'

Target function, specified as 'atan', 'exp', 'gamma', 'int', 'log', 'sincos', or 'sinhcosh'. The rewriting rules apply only to calls to the target function.

Output Arguments

Y – Expression with combined functions

symbolic variable | symbolic number | symbolic expression | symbolic vector | symbolic matrix

Expression with the combined functions, returned as a symbolic variable, number, expression, or as a vector or matrix of symbolic variables, numbers, or expressions.

Algorithms

combine applies the following rewriting rules to the input expression S, depending on the value of the target argument T.

- When T = 'exp', combine applies these rewriting rules where valid,

$$e^a e^b = e^{a+b}$$

$$(e^a)^b = e^{ab}.$$

- When T = 'log',

$$\log(a) + \log(b) = \log(ab).$$

If $b < 1000$,

$$b \log(a) = \log(a^b).$$

When $b \geq 1000$, combine does not apply this second rule.

The rules applied to rewrite logarithms do not hold for arbitrary complex values of a and b. Specify appropriate properties for a or b to enable these rewriting rules.

- When T = 'int',

$$a \int f(x) dx = \int af(x) dx$$

$$\int f(x) dx + \int g(x) dx = \int f(x) + g(x) dx$$

$$\int_a^b f(x) dx + \int_a^b g(x) dx = \int_a^b f(x) + g(x) dx$$

$$\int_a^b f(x) dx + \int_a^b g(y) dy = \int_a^b f(y) + g(y) dy$$

$$\int_a^b yf(x)dx + \int_a^b xg(y)dy = \int_a^b yf(c) + xg(c)dc.$$

- When T = 'sincos',

$$\sin(x)\sin(y) = \frac{\cos(x-y)}{2} - \frac{\cos(x+y)}{2}.$$

combine applies similar rules for $\sin(x)\cos(y)$ and $\cos(x)\cos(y)$.

$$A\cos(x) + B\sin(x) = A\sqrt{1 + \frac{B^2}{A^2}}\cos\left(x + \tan^{-1}\left(\frac{-B}{A}\right)\right).$$

- When T = 'atan' and $-1 < x < 1$, $-1 < y < 1$,

$$\operatorname{atan}(x) + \operatorname{atan}(y) = \operatorname{atan}\left(\frac{x+y}{1-xy}\right).$$

- When T = 'sinhcosh',

$$\sinh(x)\sinh(y) = \frac{\cosh(x+y)}{2} - \frac{\cosh(x-y)}{2}.$$

combine applies similar rules for $\sinh(x)\cosh(y)$ and $\cosh(x)\cosh(y)$.

combine applies the previous rules recursively to powers of \sinh and \cosh with positive integral exponents.

- When T = 'gamma',

$$a\Gamma(a) = \Gamma(a+1).$$

and,

$$\frac{\Gamma(a+1)}{\Gamma(a)} = a.$$

For positive integers n ,

$$\Gamma(-a)\Gamma(a) = -\frac{\pi}{\sin(\pi a)}.$$

See Also

Functions

collect | expand | factor | horner | numden | rewrite | simplify | simplifyFraction

Live Editor Tasks

Simplify Symbolic Expression

Topics

“Choose Function to Rearrange Expression” on page 2-104

“Simplify Symbolic Expressions” on page 2-81

“Simplify Symbolic Expressions Using Live Editor Task” on page 2-94

Introduced in R2014a

compose

Functional composition

Syntax

```
compose(f,g)
compose(f,g,z)
compose(f,g,x,z)
compose(f,g,x,y,z)
```

Description

`compose(f,g)` returns $f(g(y))$ where $f = f(x)$ and $g = g(y)$. Here x is the symbolic variable of f as defined by `symvar` and y is the symbolic variable of g as defined by `symvar`.

`compose(f,g,z)` returns $f(g(z))$ where $f = f(x)$, $g = g(y)$, and x and y are the symbolic variables of f and g as defined by `symvar`.

`compose(f,g,x,z)` returns $f(g(z))$ and makes x the independent variable for f . That is, if $f = \cos(x/t)$, then `compose(f,g,x,z)` returns $\cos(g(z)/t)$ whereas `compose(f,g,t,z)` returns $\cos(x/g(z))$.

`compose(f,g,x,y,z)` returns $f(g(z))$ and makes x the independent variable for f and y the independent variable for g . For $f = \cos(x/t)$ and $g = \sin(y/u)$, `compose(f,g,x,y,z)` returns $\cos(\sin(z/u)/t)$ whereas `compose(f,g,x,u,z)` returns $\cos(\sin(y/z)/t)$.

Examples

Compose Functions From Expressions

Show functional composition by creating functions from existing functions.

Declare functions.

```
syms x y z t u
f = 1/(1 + x^2);
g = sin(y);
h = x^t;
p = exp(-y/u);
```

Compose functions with different functions and variables as inputs.

```
a = compose(f,g)
a =
1/(sin(y)^2 + 1)
b = compose(f,g,t)
b =
1/(sin(t)^2 + 1)
```

```
c = compose(h,g,x,z)
```

```
c =  
sin(z)^t
```

```
d = compose(h,g,t,z)
```

```
d =  
x^sin(z)
```

```
e = compose(h,p,x,y,z)
```

```
e =  
exp(-z/u)^t
```

Input Arguments

f – Input

symbolic function | symbolic expression

Input, specified as a symbolic function or expression.

g – Input

symbolic function | symbolic expression

Input, specified as a symbolic function or expression.

x – Symbolic variable

symbolic variable

Symbolic variable, specified as a symbolic variable.

y – Symbolic variable

symbolic variable

Symbolic variable, specified as a symbolic variable.

z – Symbolic variable

symbolic variable

Symbolic variable, specified as a symbolic variable.

See Also

[finverse](#) | [subs](#) | [syms](#)

Introduced before R2006a

cond

Condition number of matrix

Syntax

```
cond(A)
cond(A,P)
```

Description

`cond(A)` returns the 2-norm condition number of matrix A.

`cond(A,P)` returns the P-norm condition number of matrix A.

Examples

Compute 2-Norm Condition Number of Matrix

Compute the 2-norm condition number of the inverse of the 3-by-3 magic square A.

```
A = inv(sym(magic(3)));
condN2 = cond(A)
```

```
condN2 =
(5*3^(1/2))/2
```

Use `vpa` to approximate the result.

```
vpa(condN2, 20)
```

```
ans =
4.3301270189221932338186158537647
```

Compute Different Condition Numbers of Matrix

Compute the 1-norm condition number, the Frobenius condition number, and the infinity condition number of the inverse of the 3-by-3 magic square A.

```
A = inv(sym(magic(3)));
condN1 = cond(A, 1)
condNf = cond(A, 'fro')
condNi = cond(A, inf)
```

```
condN1 =
16/3
```

```
condNf =
(285^(1/2)*391^(1/2))/60
```

- `cond(A,2)` or `cond(A)` returns the 2-norm condition number.
- `cond(A,inf)` returns the infinity norm condition number.
- `cond(A,'fro')` returns the Frobenius norm condition number.

More About

Condition Number of a Matrix

Condition number of a matrix is the ratio of the largest singular value of that matrix to the smallest singular value. The P-norm condition number of the matrix A is defined as $\text{norm}(A,P) \cdot \text{norm}(\text{inv}(A),P)$.

Tips

- Calling `cond` for a numeric matrix that is not a symbolic object invokes the MATLAB `cond` function.

See Also

`equationsToMatrix` | `inv` | `linsolve` | `norm` | `rank`

Introduced in R2012b

conj

Complex conjugate of symbolic input

Syntax

```
conj(x)
```

Description

`conj(x)` returns the complex conjugate of x . Because symbolic variables are complex by default, unresolved calls, such as `conj(x)`, can appear in the output of `norm`, `mtimes`, and other functions. For details, see “Use Assumptions on Symbolic Variables” on page 1-24.

For complex x , $\text{conj}(x) = \text{real}(x) - i*\text{imag}(x)$.

Examples

Conjugate of Numeric and Symbolic Input

Compute the conjugate of numeric input.

```
conj(1+3i)
ans =
    1.0000 - 3.0000i
```

Compute the conjugate of symbolic input.

```
syms x
f = x^2;
fConj = conj(f)

fConj =
conj(x)^2
```

Convert symbolic output to double by substituting for x with a number by using `subs`, and then using `double`.

```
fConj = subs(fConj,x,1+2i);      % x is 1+2i
fConj = double(fConj)

fConj =
    -3.0000 - 4.0000i
```

Conjugate of Real Inputs Using Assumptions

If the input is real, `conj` returns the input instead of an unresolved call. Assume x is real and find its conjugate. `conj` returns x instead of `conj(x)`, as expected.

```
syms x
assume(x,'real')
conj(x)
```

```
ans =  
x
```

Clear the assumption for further computations.

```
assume(x, 'clear')
```

Input Arguments

x — Input

number | vector | matrix | array | symbolic number | symbolic variable | symbolic array | symbolic function | symbolic expression

Input, specified as a number, vector, matrix, or array, or a symbolic number, variable, array, function, or expression.

See Also

`imag` | `real`

Introduced before R2006a

convertMuPADNotebook

Convert MuPAD notebook to MATLAB live script

Syntax

```
convertMuPADNotebook(MuPADfile, MATLABLiveScript)  
convertMuPADNotebook(MuPADfile)
```

Description

`convertMuPADNotebook(MuPADfile, MATLABLiveScript)` converts a MuPAD notebook file `MuPADfile` (.mn) to a MATLAB live script file `MATLABLiveScript` (.mlx). Both `MuPADfile` and `MATLABLiveScript` must be full paths unless the files are in the current folder. For information on live scripts, see “Create Live Scripts in the Live Editor” (MATLAB).

`convertMuPADNotebook(MuPADfile)` uses the same name and path, `MuPADfile`, for the MATLAB live script file that contains converted code. The extension .mn changes to .mlx in the resulting MATLAB live script file.

Examples

Convert MuPAD Notebook to MATLAB Script

Using `convertMuPADNotebook`, convert a MuPAD notebook to a MATLAB live script. Alternatively, right-click the notebook in the Current Folder browser and select **Open as Live Script** from the context menu.

Suppose that your current folder contains a MuPAD notebook named `myNotebook.mn`. Convert this notebook to the MATLAB live script file named `myScript.mlx`.

```
convertMuPADNotebook('myNotebook.mn', 'myScript.mlx')
```

Open the resulting file.

```
edit('myScript.mlx')
```

Visually check the code for correctness and completeness. Then verify it by running it.

Use Same Name for Converted File

Convert a MuPAD notebook to a MATLAB live script file with the same name.

Suppose that your current folder contains a MuPAD notebook named `myFile.mn`. Convert this notebook to the MATLAB live script file named `myFile.mlx`.

```
convertMuPADNotebook('myFile.mn')
```

Open the resulting file.

```
edit('myFile.mlx')
```

Visually check the code for correctness and completeness. Then verify it by executing it.

Fix Translation Errors or Warnings

If `convertMuPADNotebook` reports that the converted code has translation errors or warnings, correct the resulting MATLAB code before using it.

Convert the MuPAD notebook, `myNotebook.mn`, to the MATLAB live script file, `myScript.mlx`. Because `myNotebook.mn` contains commands that cannot be directly translated to MATLAB code, `convertMuPADNotebook` flags these commands as translation errors and warnings.

```
convertMuPADNotebook('myNotebook.mn','myScript.mlx')
```

```
Created 'myScript.mlx': 4 translation errors, 1 warnings. For verifying...
the document, see help.
```

```
ans =
c:\MATLABscripts\myScript.mlx
```

A translation error indicates that `convertMuPADNotebook` was unable to convert part of the MuPAD notebook, and that without this part the translated code will not run properly. A translation warning indicates that `convertMuPADNotebook` was unable to convert a part of the MuPAD notebook (for example, an empty input region) and ignored it. Converted code containing warnings is likely to run without any issues.

Open the resulting file.

```
edit('myScript.mlx');
```

Eliminate translation errors. First, search for “translation error”. Next to “translation error”, the converted code displays short comments explaining which MuPAD command did not translate properly. There is also a link to documentation that provides more details and suggestions for fixing the issue. After fixing the issue, remove the corresponding error message and any comments related to it.

Find translation warnings by searching for “translation warning”. The converted code displays a short comment and a link to documentation next to “translation warning”. Some warnings might require you to adapt the code so it runs properly. In most cases, you can ignore translation warnings. Whether you fixed the code or decided to ignore the warning, remove the warning message and any comments related to it.

Visually check the code for correctness and completeness.

Verify that the resulting MATLAB code runs properly by executing it.

Convert All Notebooks in a Folder

Convert all MuPAD notebooks in a folder by making it your current folder, and then using a loop to call the `convertMuPADNotebook` function on every notebook in the folder.

```
files = dir('*.*mn');
for i = 1:numel(files)
    convertMuPADNotebook(files(i).name)
end
```

Convert MuPAD Procedure to MATLAB Function

`convertMuPADNotebook` converts MuPAD procedures to MATLAB functions. Not all MuPAD procedures can be converted.

Simple procedures are converted into anonymous functions. Convert a MuPAD notebook with the following code.

```
f := x -> x^2  
f(2)
```

The output of `convertMuPADNotebook` is a live script with the anonymous function `f`.

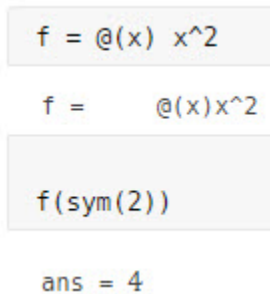

```
f = @(x) x^2  
  
f =      @(x)x^2  
  
f(sym(2))  
  
ans = 4
```

For details on anonymous functions, see “Anonymous Functions” (MATLAB).

When procedures are too complex to convert to anonymous functions, they are converted to local functions in the live script. Local functions are placed at the end of the live script.

Convert a MuPAD notebook with the following code.

```
x -> if x=1 then 2 else 3 end  
f(0)
```

The procedure is too complex to convert to an anonymous function. The output of `convertMuPADNotebook` is a live script with the local function `aux2`.

```
f = @aux2
```

```
f =
    @aux2
```

```
f(sym(0))
```

```
ans = 3
```

Local Functions

```
function returnValue = aux2(x)
if x == sym(1)
    aux1 = sym(2);
else
    aux1 = sym(3);
end
returnValue = aux1;
end
```

For information on local functions in scripts, see “Add Functions to Scripts” (MATLAB).

When converting a notebook that reads a MuPAD program file (.mu), `convertMuPADNotebook` replaces the `read` command with the contents of the .mu file. The notebook and program files must be in the same directory.

Input Arguments

MuPADfile — Name of MuPAD notebook

character vector

Name of a MuPAD notebook, specified as a character vector. This character vector must specify the full path to the file, unless the file is in the current folder.

Example: 'C:\MuPAD_Notebooks\myFile.mn'

MATLABLiveScript — Name of MATLAB live script file

character vector

Name of a MATLAB live script file, specified as a character vector. This character vector must specify the full path to the file, unless you intend to create a file in the current folder.

Example: 'C:\MATLAB_Scripts\myFile.mlx'

See Also

Topics

“Convert MuPAD Notebooks to MATLAB Live Scripts” on page 3-3

“Troubleshoot MuPAD to MATLAB Translation Errors” on page 3-8

“Troubleshoot MuPAD to MATLAB Translation Warnings” on page 3-15

Introduced in R2016a

COS

Symbolic cosine function

Syntax

`cos(X)`

Description

`cos(X)` returns the cosine function on page 4-207 of X.

Examples

Cosine Function for Numeric and Symbolic Arguments

Depending on its arguments, `cos` returns floating-point or exact symbolic results.

Compute the cosine function for these numbers. Because these numbers are not symbolic objects, `cos` returns floating-point results.

```
A = cos([-2, -pi, pi/6, 5*pi/7, 11])
```

```
A =
    -0.4161    -1.0000     0.8660    -0.6235     0.0044
```

Compute the cosine function for the numbers converted to symbolic objects. For many symbolic (exact) numbers, `cos` returns unresolved symbolic calls.

```
symA = cos(sym([-2, -pi, pi/6, 5*pi/7, 11]))
```

```
symA =
[ cos(2), -1, 3^(1/2)/2, -cos((2*pi)/7), cos(11)]
```

Use `vpa` to approximate symbolic results with floating-point numbers:

```
vpa(symA)
```

```
ans =
[ -0.41614683654714238699756822950076, ...
  -1.0, ...
  0.86602540378443864676372317075294, ...
  -0.62348980185873353052500488400424, ...
  0.0044256979880507857483550247239416]
```

Plot Cosine Function

Plot the cosine function on the interval from -4π to 4π .

```
syms x
fplot(cos(x),[-4*pi 4*pi])
grid on
```

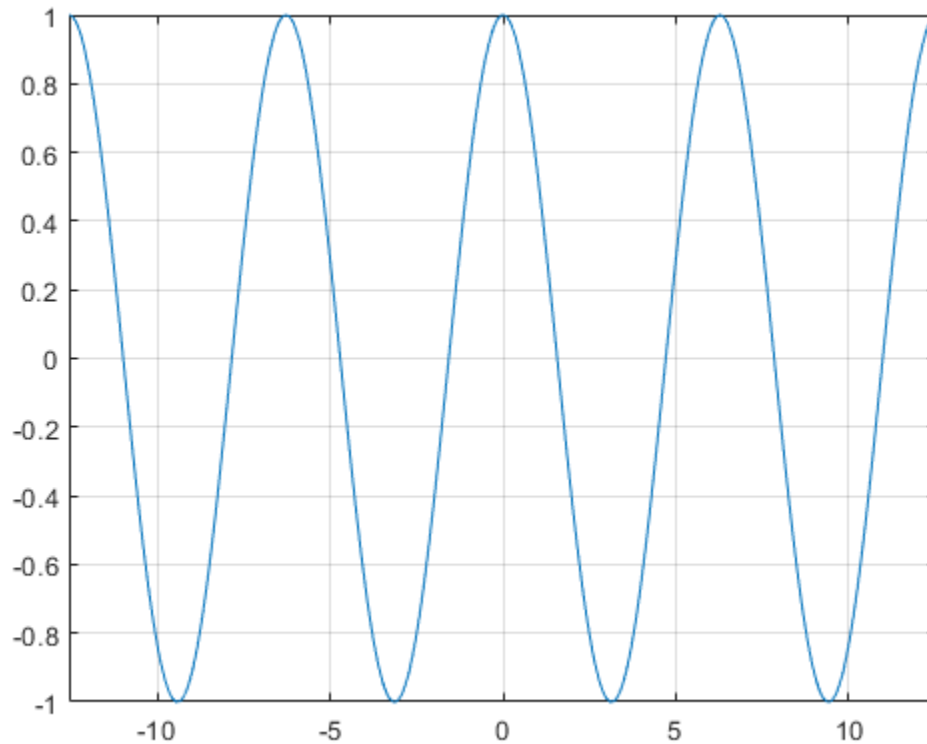

Handle Expressions Containing Cosine Function

Many functions, such as `diff`, `int`, `taylor`, and `rewrite`, can handle expressions containing `cos`.

Find the first and second derivatives of the cosine function:

```
syms x
diff(cos(x), x)
diff(cos(x), x, x)
```

```
ans =
-sin(x)
```

```
ans =
-cos(x)
```

Find the indefinite integral of the cosine function:

```
int(cos(x), x)
```

```
ans =
sin(x)
```

Find the Taylor series expansion of `cos(x)`:

```
taylor(cos(x), x)
```

```
ans =
x^4/24 - x^2/2 + 1
```

Rewrite the cosine function in terms of the exponential function:

```
rewrite(cos(x), 'exp')
```

```
ans =
exp(-x*1i)/2 + exp(x*1i)/2
```

Evaluate Units with cos Function

cos numerically evaluates these units automatically: radian, degree, arcmin, arcsec, and revolution.

Show this behavior by finding the cosine of x degrees and 2 radians.

```
u = symunit;
syms x
f = [x*u.degree 2*u.radian];
cosinf = cos(f)

cosinf =
[ cos((pi*x)/180), cos(2)]
```

You can calculate cosinf by substituting for x using subs and then using double or vpa.

Input Arguments

X — Input

symbolic number | symbolic variable | symbolic expression | symbolic function | symbolic vector | symbolic matrix

Input, specified as a symbolic number, variable, expression, or function, or as a vector or matrix of symbolic numbers, variables, expressions, or functions.

More About

Cosine Function

The cosine of an angle, α , defined with reference to a right angled triangle is

$$\cos(\alpha) = \frac{\text{adjacent side}}{\text{hypotenuse}} = \frac{b}{h}.$$

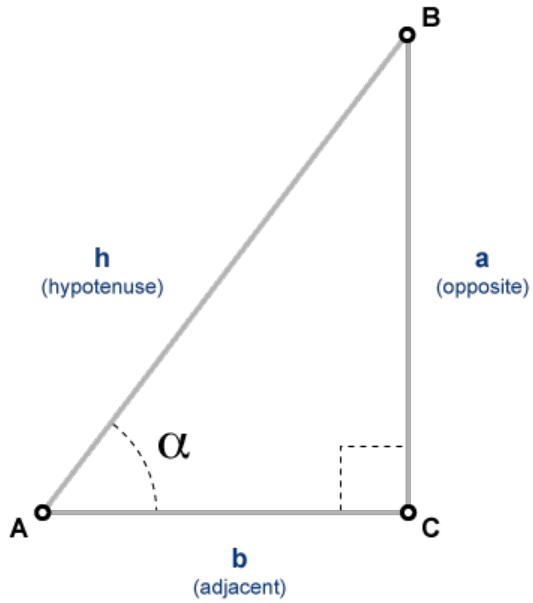

The cosine of a complex argument, α , is

$$\cos(\alpha) = \frac{e^{i\alpha} + e^{-i\alpha}}{2} .$$

See Also

acos | acot | acsc | asec | asin | atan | cot | csc | sec | sin | tan

Introduced before R2006a

cosh

Symbolic hyperbolic cosine function

Syntax

`cosh(X)`

Description

`cosh(X)` returns the hyperbolic cosine function of X .

Examples

Hyperbolic Cosine Function for Numeric and Symbolic Arguments

Depending on its arguments, `cosh` returns floating-point or exact symbolic results.

Compute the hyperbolic cosine function for these numbers. Because these numbers are not symbolic objects, `cosh` returns floating-point results.

```
A = cosh([-2, -pi*i, pi*i/6, 5*pi*i/7, 3*pi*i/2])
```

```
A =
    3.7622    -1.0000    0.8660    -0.6235    -0.0000
```

Compute the hyperbolic cosine function for the numbers converted to symbolic objects. For many symbolic (exact) numbers, `cosh` returns unresolved symbolic calls.

```
symA = cosh(sym([-2, -pi*i, pi*i/6, 5*pi*i/7, 3*pi*i/2]))
```

```
symA =
[ cosh(2), -1, 3^(1/2)/2, -cosh((pi*2i)/7), 0]
```

Use `vpa` to approximate symbolic results with floating-point numbers:

```
vpa(symA)
```

```
ans =
[ 3.7621956910836314595622134777737,...
 -1.0,...
 0.86602540378443864676372317075294,...
 -0.62348980185873353052500488400424,...
 0]
```

Plot Hyperbolic Cosine Function

Plot the hyperbolic cosine function on the interval from $-\pi$ to π .

```
syms x
fplot(cosh(x),[-pi pi])
grid on
```

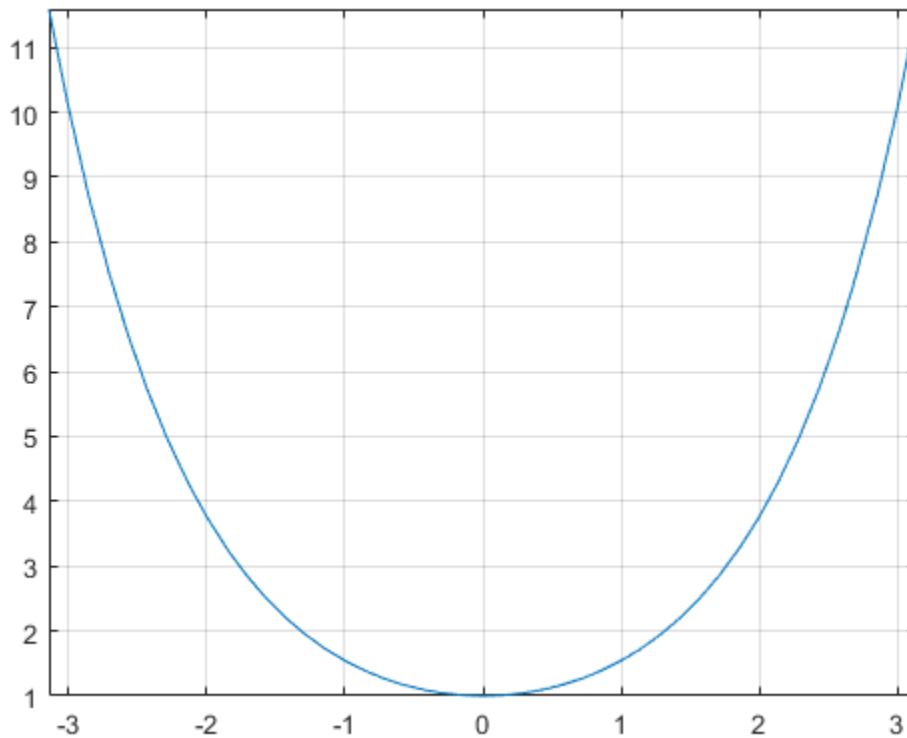

Handle Expressions Containing Hyperbolic Cosine Function

Many functions, such as `diff`, `int`, `taylor`, and `rewrite`, can handle expressions containing `cosh`.

Find the first and second derivatives of the hyperbolic cosine function:

```
syms x
diff(cosh(x), x)
diff(cosh(x), x, x)
```

```
ans =
sinh(x)
```

```
ans =
cosh(x)
```

Find the indefinite integral of the hyperbolic cosine function:

```
int(cosh(x), x)
```

```
ans =
sinh(x)
```

Find the Taylor series expansion of $\cosh(x)$:

```
taylor(cosh(x), x)
```



```
ans =  
x^4/24 + x^2/2 + 1
```

Rewrite the hyperbolic cosine function in terms of the exponential function:

```
rewrite(cosh(x), 'exp')
```

```
ans =  
exp(-x)/2 + exp(x)/2
```

Input Arguments

X — Input

symbolic number | symbolic variable | symbolic expression | symbolic function | symbolic vector | symbolic matrix

Input, specified as a symbolic number, variable, expression, or function, or as a vector or matrix of symbolic numbers, variables, expressions, or functions.

See Also

acosh | acoth | acsch | asech | asinh | atanh | coth | csch | sech | sinh | tanh

Introduced before R2006a

coshint

Hyperbolic cosine integral function

Syntax

`coshint(X)`

Description

`coshint(X)` returns the hyperbolic cosine integral function on page 4-214 of X.

Examples

Hyperbolic Cosine Integral Function for Numeric and Symbolic Arguments

Depending on its arguments, `coshint` returns floating-point or exact symbolic results.

Compute the hyperbolic cosine integral function for these numbers. Because these numbers are not symbolic objects, `coshint` returns floating-point results.

```
A = coshint([-1, 0, 1/2, 1, pi/2, pi])
A =
    0.8379 + 3.1416i    -Inf + 0.0000i    -0.0528 + 0.0000i    0.8379...
    + 0.0000i    1.7127 + 0.0000i    5.4587 + 0.0000i
```

Compute the hyperbolic cosine integral function for the numbers converted to symbolic objects. For many symbolic (exact) numbers, `coshint` returns unresolved symbolic calls.

```
symA = coshint(sym([-1, 0, 1/2, 1, pi/2, pi]))
symA =
[ coshint(1) + pi*1i, -Inf, coshint(1/2), coshint(1), coshint(pi/2), coshint(pi)]
```

Use `vpa` to approximate symbolic results with floating-point numbers:

```
vpa(symA)
ans =
[ 0.83786694098020824089467857943576...
  + 3.1415926535897932384626433832795i,...
 -Inf,...
 -0.052776844956493615913136063326141,...
 0.83786694098020824089467857943576,...
 1.7126607364844281079951569897796,...
 5.4587340442160681980014878977798]
```

Plot Hyperbolic Cosine Integral Function

Plot the hyperbolic cosine integral function on the interval from 0 to 2π .

```
syms x
fplot(coshint(x), [0 2*pi])
grid on
```

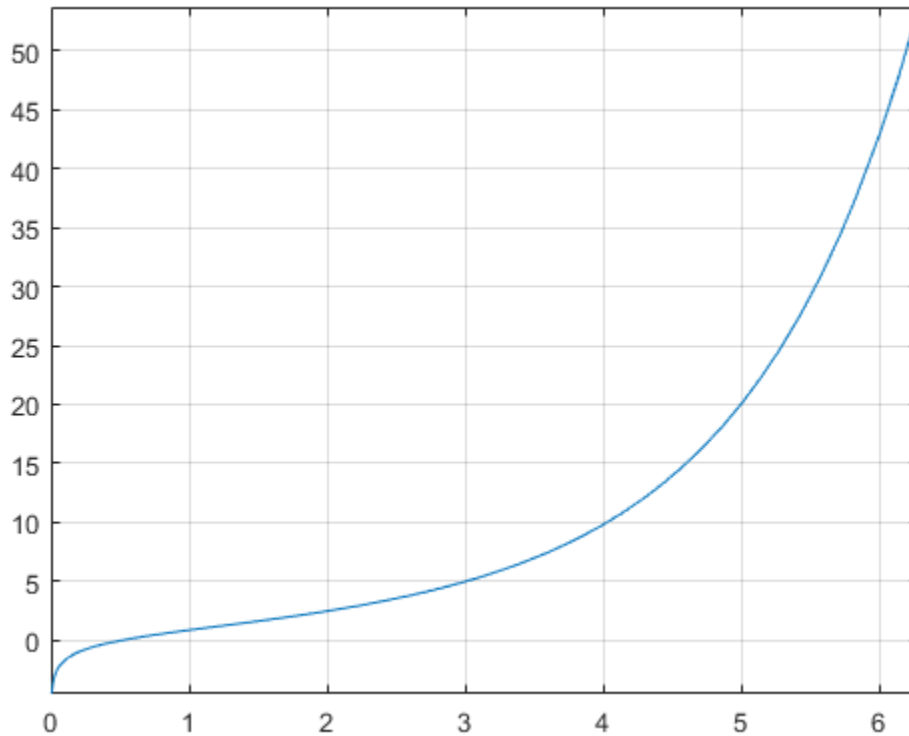

Handle Expressions Containing Hyperbolic Cosine Integral Function

Many functions, such as `diff` and `int`, can handle expressions containing `coshint`.

Find the first and second derivatives of the hyperbolic cosine integral function:

```
syms x
diff(coshint(x), x)
diff(coshint(x), x, x)
```

```
ans =
cosh(x)/x
```

```
ans =
sinh(x)/x - cosh(x)/x^2
```

Find the indefinite integral of the hyperbolic cosine integral function:

```
int(coshint(x), x)
```

```
ans =
x*coshint(x) - sinh(x)
```

Input Arguments

X — Input

symbolic number | symbolic variable | symbolic expression | symbolic function | symbolic vector | symbolic matrix

Input, specified as a symbolic number, variable, expression, or function, or as a vector or matrix of symbolic numbers, variables, expressions, or functions.

More About

Hyperbolic Cosine Integral Function

The hyperbolic cosine integral function is defined as follows:

$$\text{Chi}(x) = \gamma + \log(x) + \int_0^x \frac{\cosh(t) - 1}{t} dt$$

Here, γ is the Euler-Mascheroni constant:

$$\gamma = \lim_{n \rightarrow \infty} \left(\left(\sum_{k=1}^n \frac{1}{k} \right) - \ln(n) \right)$$

References

- [1] Cautschi, W. and W. F. Cahill. "Exponential Integral and Related Functions." *Handbook of Mathematical Functions with Formulas, Graphs, and Mathematical Tables*. (M. Abramowitz and I. A. Stegun, eds.). New York: Dover, 1972.

See Also

cos | cosint | eulergamma | int | sinhint | sinint | ssinint

Introduced in R2014a

cosint

Cosine integral function

Syntax

```
cosint(X)
```

Description

`cosint(X)` returns the cosine integral function on page 4-217 of X.

Examples

Cosine Integral Function for Numeric and Symbolic Arguments

Depending on its arguments, `cosint` returns floating-point or exact symbolic results.

Compute the cosine integral function for these numbers. Because these numbers are not symbolic objects, `cosint` returns floating-point results.

```
A = cosint([- 1, 0, pi/2, pi, 1])
```

```
A =
    0.3374 + 3.1416i    -Inf + 0.0000i    0.4720 + 0.0000i...
    0.0737 + 0.0000i    0.3374 + 0.0000i
```

Compute the cosine integral function for the numbers converted to symbolic objects. For many symbolic (exact) numbers, `cosint` returns unresolved symbolic calls.

```
symA = cosint(sym([- 1, 0, pi/2, pi, 1]))
```

```
symA =
[ cosint(1) + pi*1i, -Inf, cosint(pi/2), cosint(pi), cosint(1)]
```

Use `vpa` to approximate symbolic results with floating-point numbers:

```
vpa(symA)
```

```
ans =
[ 0.33740392290096813466264620388915...
 + 3.1415926535897932384626433832795i,...
 -Inf,...
 0.47200065143956865077760610761413,...
 0.07366791204642548599010096523015,...
 0.33740392290096813466264620388915]
```

Plot Cosine Integral Function

Plot the cosine integral function on the interval from 0 to 4π .

```
syms x
fplot(cosint(x),[0 4*pi])
grid on
```

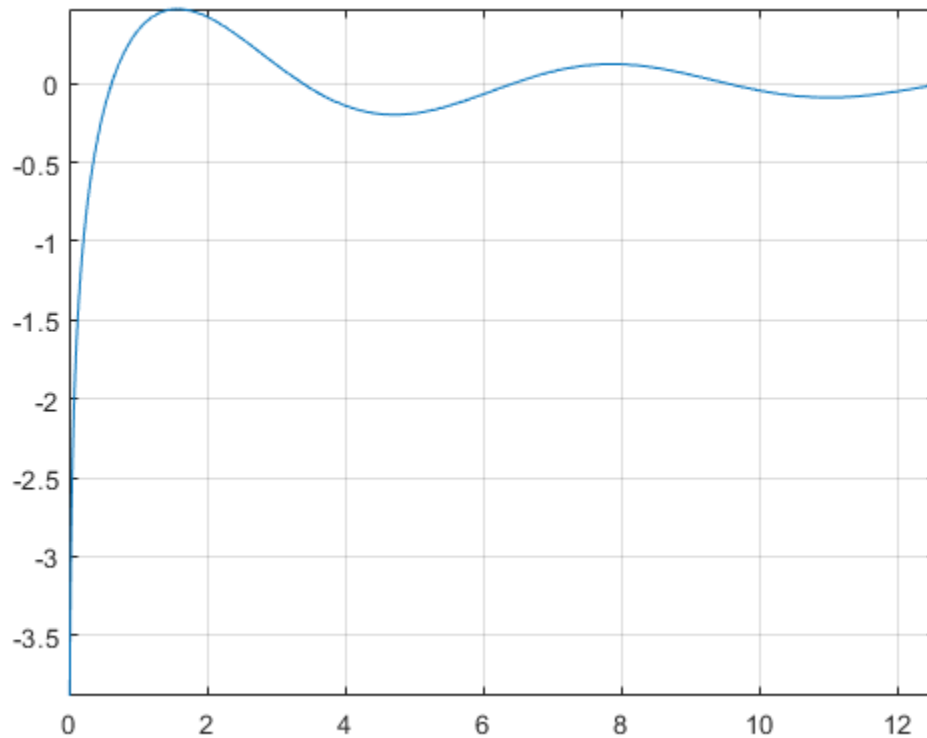

Handle Expressions Containing Cosine Integral Function

Many functions, such as `diff` and `int`, can handle expressions containing `cosint`.

Find the first and second derivatives of the cosine integral function:

```
syms x
diff(cosint(x), x)
diff(cosint(x), x, x)
```

```
ans =
cos(x)/x
```

```
ans =
- cos(x)/x^2 - sin(x)/x
```

Find the indefinite integral of the cosine integral function:

```
int(cosint(x), x)
```

```
ans =
x*cosint(x) - sin(x)
```

Input Arguments

X — Input

symbolic number | symbolic variable | symbolic expression | symbolic function | symbolic vector | symbolic matrix

Input, specified as a symbolic number, variable, expression, or function, or as a vector or matrix of symbolic numbers, variables, expressions, or functions.

More About

Cosine Integral Function

The cosine integral function is defined as follows:

$$\text{Ci}(x) = \gamma + \log(x) + \int_0^x \frac{\cos(t) - 1}{t} dt$$

Here, γ is the Euler-Mascheroni constant:

$$\gamma = \lim_{n \rightarrow \infty} \left(\left(\sum_{k=1}^n \frac{1}{k} \right) - \ln(n) \right)$$

References

- [1] Gautschi, W. and W. F. Cahill. "Exponential Integral and Related Functions." *Handbook of Mathematical Functions with Formulas, Graphs, and Mathematical Tables*. (M. Abramowitz and I. A. Stegun, eds.). New York: Dover, 1972.

See Also

cos | coshint | eulergamma | int | sinhint | sinint | ssinint

Introduced before R2006a

cot

Symbolic cotangent function

Syntax

```
cot(X)
```

Description

`cot(X)` returns the cotangent function on page 4-220 of X.

Examples

Cotangent Function for Numeric and Symbolic Arguments

Depending on its arguments, `cot` returns floating-point or exact symbolic results.

Compute the cotangent function for these numbers. Because these numbers are not symbolic objects, `cot` returns floating-point results.

```
A = cot([-2, -pi/2, pi/6, 5*pi/7, 11])
```

```
A =  
    0.4577    -0.0000    1.7321    -0.7975    -0.0044
```

Compute the cotangent function for the numbers converted to symbolic objects. For many symbolic (exact) numbers, `cot` returns unresolved symbolic calls.

```
symA = cot(sym([-2, -pi/2, pi/6, 5*pi/7, 11]))
```

```
symA =  
[ -cot(2), 0, 3^(1/2), -cot((2*pi)/7), cot(11)]
```

Use `vpa` to approximate symbolic results with floating-point numbers:

```
vpa(symA)
```

```
ans =  
[ 0.45765755436028576375027741043205,...  
 0,...  
 1.7320508075688772935274463415059,...  
 -0.79747338888240396141568825421443,...  
 -0.0044257413313241136855482762848043]
```

Plot Cotangent Function

Plot the cotangent function on the interval from $-\pi$ to π .

```
syms x  
fplot(cot(x),[-pi pi])  
grid on
```

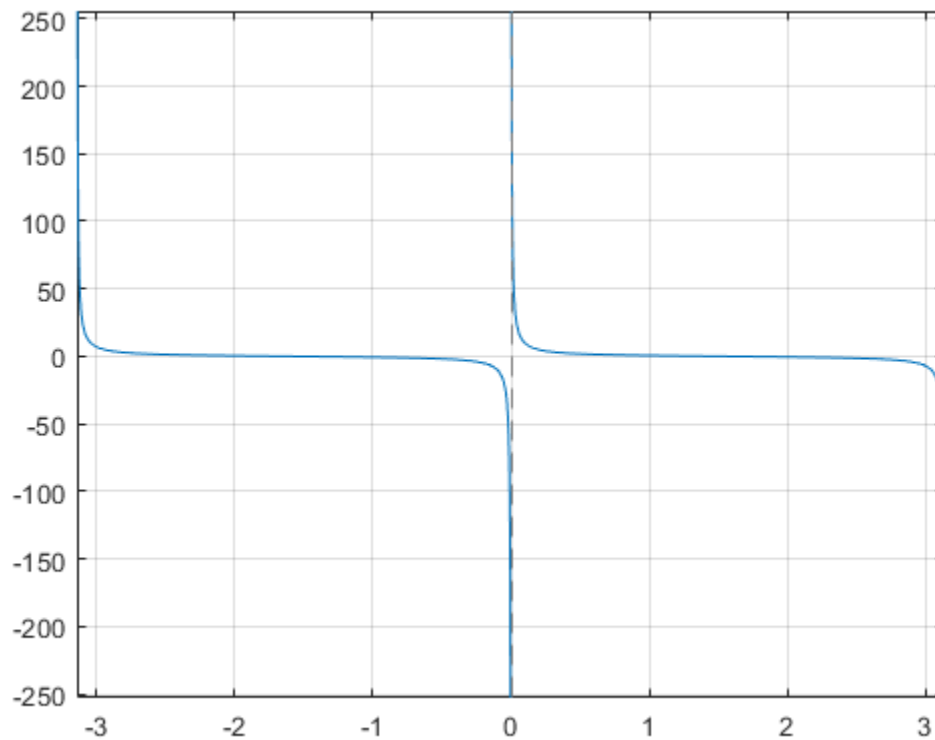
Handle Expressions Containing Cotangent Function

Many functions, such as `diff`, `int`, `taylor`, and `rewrite`, can handle expressions containing `cot`.

Find the first and second derivatives of the cotangent function:

```
syms x
diff(cot(x), x)
diff(cot(x), x, x)
```

```
ans =
- cot(x)^2 - 1
```

```
ans =
2*cot(x)*(cot(x)^2 + 1)
```

Find the indefinite integral of the cotangent function:

```
int(cot(x), x)
```

```
ans =
log(sin(x))
```

Find the Taylor series expansion of `cot(x)` around $x = \pi/2$:

```
taylor(cot(x), x, pi/2)
```

```
ans =  
pi/2 - x - (x - pi/2)^3/3 - (2*(x - pi/2)^5)/15
```

Rewrite the cotangent function in terms of the sine and cosine functions:

```
rewrite(cot(x), 'sincos')
```

```
ans =  
cos(x)/sin(x)
```

Rewrite the cotangent function in terms of the exponential function:

```
rewrite(cot(x), 'exp')
```

```
ans =  
(exp(x*2i)*1i + 1i)/(exp(x*2i) - 1)
```

Evaluate Units with cot Function

`cot` numerically evaluates these units automatically: radian, degree, arcmin, arcsec, and revolution.

Show this behavior by finding the cotangent of x degrees and 2 radians.

```
u = symunit;  
syms x  
f = [x*u.degree 2*u.radian];  
cotf = cot(f)  
  
cotf =  
[ cot((pi*x)/180), cot(2)]
```

You can calculate `cot f` by substituting for x using `subs` and then using `double` or `vpa`.

Input Arguments

X — Input

symbolic number | symbolic variable | symbolic expression | symbolic function | symbolic vector | symbolic matrix

Input, specified as a symbolic number, variable, expression, or function, or as a vector or matrix of symbolic numbers, variables, expressions, or functions.

More About

Cotangent Function

The cotangent of an angle, α , defined with reference to a right angled triangle is

$$\cot(\alpha) = \frac{1}{\tan(\alpha)} = \frac{\text{adjacent side}}{\text{opposite side}} = \frac{b}{a} .$$

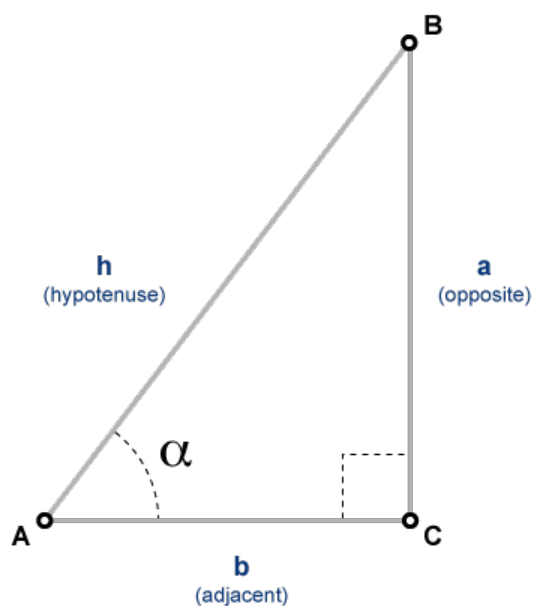

The cotangent of a complex argument α is

$$\cot(\alpha) = \frac{i(e^{i\alpha} + e^{-i\alpha})}{(e^{i\alpha} - e^{-i\alpha})}.$$

See Also

acos | acot | acsc | asec | asin | atan | cos | csc | sec | sin | tan

Introduced before R2006a

coth

Symbolic hyperbolic cotangent function

Syntax

`coth(X)`

Description

`coth(X)` returns the hyperbolic cotangent function of X

Examples

Hyperbolic Cotangent Function for Numeric and Symbolic Arguments

Depending on its arguments, `coth` returns floating-point or exact symbolic results.

Compute the hyperbolic cotangent function for these numbers. Because these numbers are not symbolic objects, `coth` returns floating-point results.

```
A = coth([-2, -pi*i/3, pi*i/6, 5*pi*i/7, 3*pi*i/2])
A =
-1.0373 + 0.0000i    0.0000 + 0.5774i    0.0000 - 1.7321i...
 0.0000 + 0.7975i    0.0000 - 0.0000i
```

Compute the hyperbolic cotangent function for the numbers converted to symbolic objects. For many symbolic (exact) numbers, `coth` returns unresolved symbolic calls.

```
symA = coth(sym([-2, -pi*i/3, pi*i/6, 5*pi*i/7, 3*pi*i/2]))
symA =
[ -coth(2), (3^(1/2)*1i)/3, -3^(1/2)*1i, -coth((pi*2i)/7), 0]
```

Use `vpa` to approximate symbolic results with floating-point numbers:

```
vpa(symA)
ans =
[ -1.0373147207275480958778097647678,...
 0.57735026918962576450914878050196i,...
 -1.7320508075688772935274463415059i,...
 0.79747338888240396141568825421443i,...
 0]
```

Plot Hyperbolic Cotangent Function

Plot the hyperbolic cotangent function on the interval from -10 to 10.

```
syms x
fplot(coth(x),[-10 10])
grid on
```

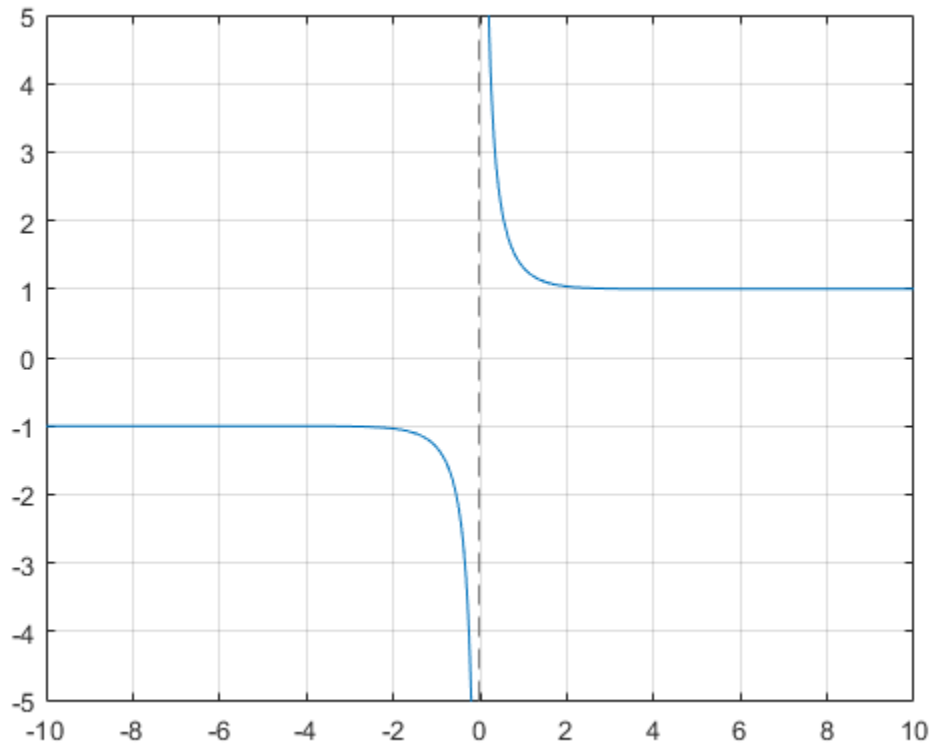

Handle Expressions Containing Hyperbolic Cotangent Function

Many functions, such as `diff`, `int`, `taylor`, and `rewrite`, can handle expressions containing `coth`.

Find the first and second derivatives of the hyperbolic cotangent function:

```
syms x
diff(coth(x), x)
diff(coth(x), x, x)
```

```
ans =
1 - coth(x)^2
```

```
ans =
2*coth(x)*(coth(x)^2 - 1)
```

Find the indefinite integral of the hyperbolic cotangent function:

```
int(coth(x), x)
```

```
ans =
log(sinh(x))
```

Find the Taylor series expansion of `coth(x)` around $x = \pi*i/2$:

```
taylor(coth(x), x, pi*i/2)
```

```
ans =  
x - (pi*1i)/2 - (x - (pi*1i)/2)^3/3 + (2*(x - (pi*1i)/2)^5)/15
```

Rewrite the hyperbolic cotangent function in terms of the exponential function:

```
rewrite(coth(x), 'exp')
```

```
ans =  
(exp(2*x) + 1)/(exp(2*x) - 1)
```

Input Arguments

X — Input

symbolic number | symbolic variable | symbolic expression | symbolic function | symbolic vector | symbolic matrix

Input, specified as a symbolic number, variable, expression, or function, or as a vector or matrix of symbolic numbers, variables, expressions, or functions.

See Also

acosh | acoth | acsch | asech | asinh | atanh | cosh | csch | sech | sinh | tanh

Introduced before R2006a

CSC

Symbolic cosecant function

Syntax

`csc(X)`

Description

`csc(X)` returns the cosecant function on page 4-227 of X.

Examples

Cosecant Function for Numeric and Symbolic Arguments

Depending on its arguments, `csc` returns floating-point or exact symbolic results.

Compute the cosecant function for these numbers. Because these numbers are not symbolic objects, `csc` returns floating-point results.

```
A = csc([-2, -pi/2, pi/6, 5*pi/7, 11])
A =
   -1.0998   -1.0000    2.0000    1.2790   -1.0000
```

Compute the cosecant function for the numbers converted to symbolic objects. For many symbolic (exact) numbers, `csc` returns unresolved symbolic calls.

```
symA = csc(sym([-2, -pi/2, pi/6, 5*pi/7, 11]))
symA =
[ -1/sin(2), -1, 2, 1/sin((2*pi)/7), 1/sin(11)]
```

Use `vpa` to approximate symbolic results with floating-point numbers:

```
vpa(symA)
ans =
[ -1.0997501702946164667566973970263,...
  -1.0,...
  2.0,...
  1.2790480076899326057478506072714,...
  -1.0000097935452091313874644503551]
```

Plot Cosecant Function

Plot the cosecant function on the interval from -4π to 4π .

```
syms x
fplot(csc(x),[-4*pi 4*pi])
grid on
```

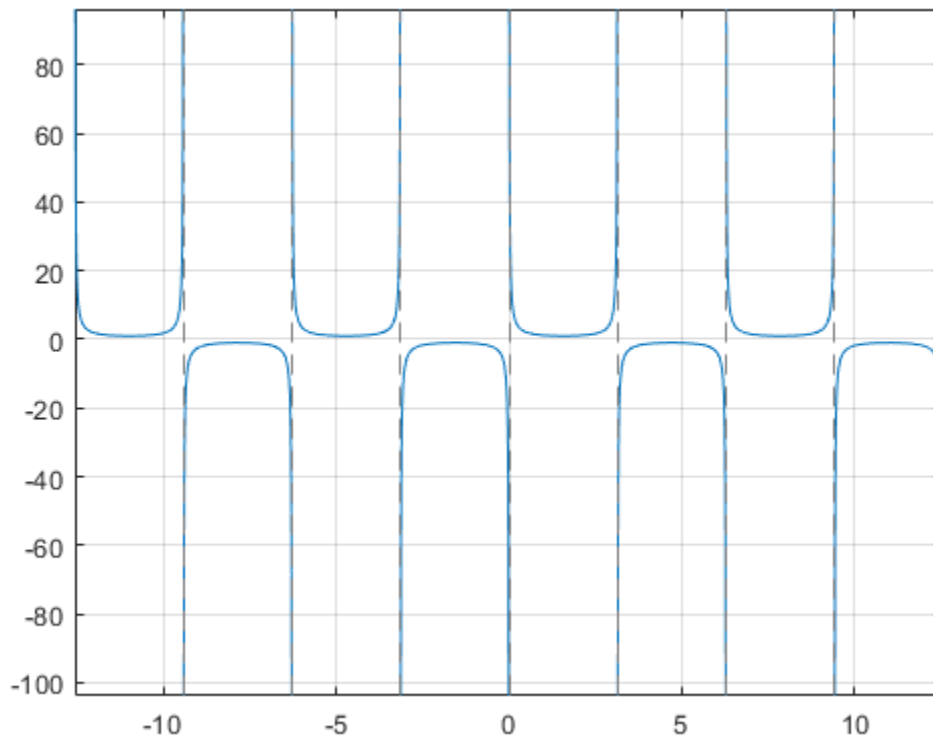

Handle Expressions Containing Cosecant Function

Many functions, such as `diff`, `int`, `taylor`, and `rewrite`, can handle expressions containing `csc`.

Find the first and second derivatives of the cosecant function:

```
syms x
diff(csc(x), x)
diff(csc(x), x, x)
```

```
ans =
-cos(x)/sin(x)^2
```

```
ans =
1/sin(x) + (2*cos(x)^2)/sin(x)^3
```

Find the indefinite integral of the cosecant function:

```
int(csc(x), x)
```

```
ans =
log(tan(x/2))
```

Find the Taylor series expansion of `csc(x)` around $x = \pi/2$:

```
taylor(csc(x), x, pi/2)
```



```
ans =
(x - pi/2)^2/2 + (5*(x - pi/2)^4)/24 + 1
```

Rewrite the cosecant function in terms of the exponential function:

```
rewrite(csc(x), 'exp')
```

```
ans =
1/((exp(-x*1i)*1i)/2 - (exp(x*1i)*1i)/2)
```

Evaluate Units with csc Function

csc numerically evaluates these units automatically: radian, degree, arcmin, arcsec, and revolution.

Show this behavior by finding the cosecant of x degrees and 2 radians.

```
u = symunit;
syms x
f = [x*u.degree 2*u.radian];
cosecf = csc(f)

cosecf =
[ 1/sin((pi*x)/180), 1/sin(2)]
```

You can calculate cosecf by substituting for x using subs and then using double or vpa.

Input Arguments

X — Input

symbolic number | symbolic variable | symbolic expression | symbolic function | symbolic vector | symbolic matrix

Input, specified as a symbolic number, variable, expression, or function, or as a vector or matrix of symbolic numbers, variables, expressions, or functions.

More About

Cosecant Function

The cosecant of an angle, α , defined with reference to a right angled triangle is

$$\csc(\alpha) = \frac{1}{\sin(\alpha)} = \frac{\text{hypotenuse}}{\text{opposite side}} = \frac{h}{a} .$$

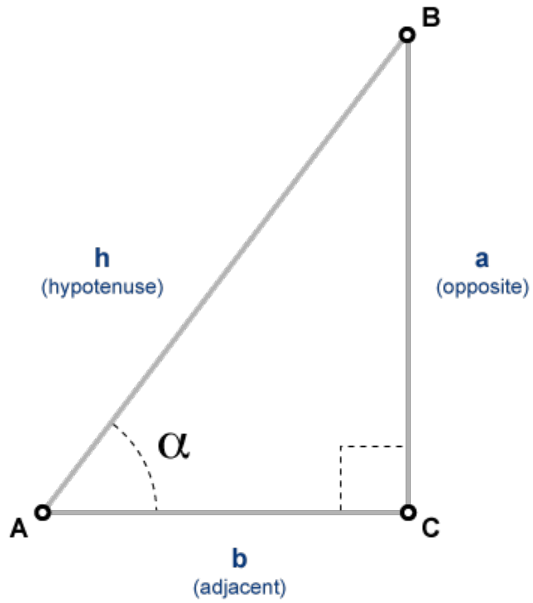

The cosecant of a complex argument, α , is

$$\operatorname{csc}(\alpha) = \frac{2i}{e^{i\alpha} - e^{-i\alpha}}.$$

See Also

acos | acot | acsc | asec | asin | atan | cos | cot | sin | tan

Introduced before R2006a

csch

Symbolic hyperbolic cosecant function

Syntax

`csch(X)`

Description

`csch(X)` returns the hyperbolic cosecant function of X .

Examples

Hyperbolic Cosecant Function for Numeric and Symbolic Arguments

Depending on its arguments, `csch` returns floating-point or exact symbolic results.

Compute the hyperbolic cosecant function for these numbers. Because these numbers are not symbolic objects, `csch` returns floating-point results.

```
A = csch([-2, -pi*i/2, 0, pi*i/3, 5*pi*i/7, pi*i/2])
```

```
A =
-0.2757 + 0.0000i    0.0000 + 1.0000i    Inf + 0.0000i...
 0.0000 - 1.1547i    0.0000 - 1.2790i    0.0000 - 1.0000i
```

Compute the hyperbolic cosecant function for the numbers converted to symbolic objects. For many symbolic (exact) numbers, `csch` returns unresolved symbolic calls.

```
symA = csch(sym([-2, -pi*i/2, 0, pi*i/3, 5*pi*i/7, pi*i/2]))
```

```
symA =
[ -1/sinh(2), 1i, Inf, -(3^(1/2)*2i)/3, 1/sinh((pi*2i)/7), -1i]
```

Use `vpa` to approximate symbolic results with floating-point numbers:

```
vpa(symA)
```

```
ans =
[ -0.27572056477178320775835148216303,...
 1.0i,...
 Inf,...
 -1.1547005383792515290182975610039i,...
 -1.2790480076899326057478506072714i,...
 -1.0i]
```

Plot Hyperbolic Cosecant Function

Plot the hyperbolic cosecant function on the interval from -10 to 10.

```
syms x
fplot(csch(x),[-10 10])
grid on
```

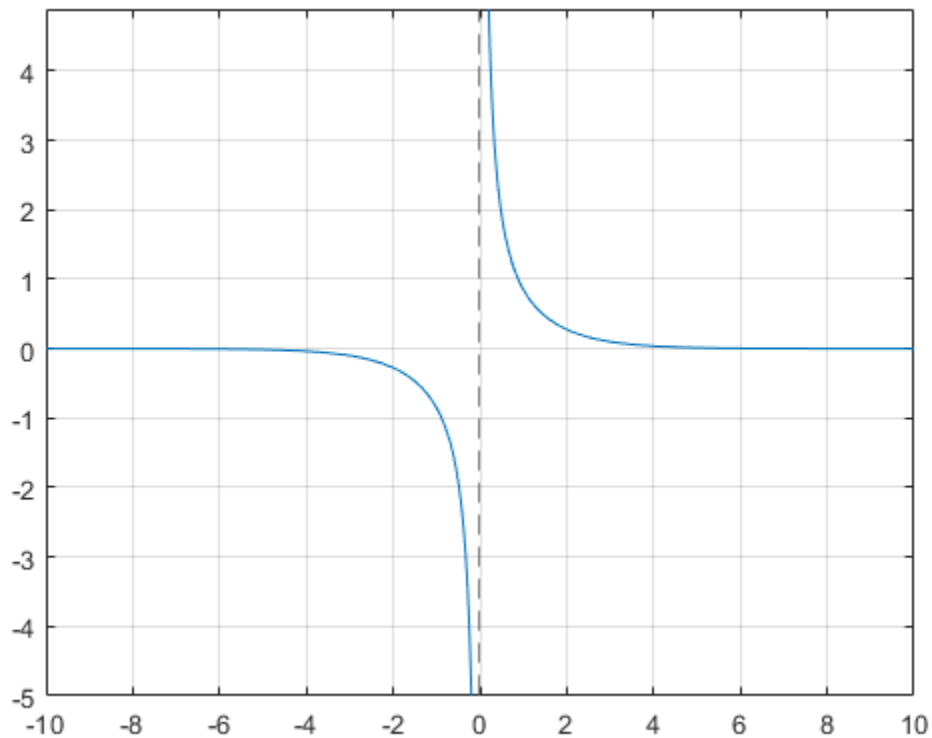

Handle Expressions Containing Hyperbolic Cosecant Function

Many functions, such as `diff`, `int`, `taylor`, and `rewrite`, can handle expressions containing `csch`.

Find the first and second derivatives of the hyperbolic cosecant function:

```
syms x
diff(csch(x), x)
diff(csch(x), x, x)
```

```
ans =
-cosh(x)/sinh(x)^2
```

```
ans =
(2*cosh(x)^2)/sinh(x)^3 - 1/sinh(x)
```

Find the indefinite integral of the hyperbolic cosecant function:

```
int(csch(x), x)
```

```
ans =
log(tanh(x/2))
```

Find the Taylor series expansion of `csch(x)` around $x = \pi*i/2$:

```
taylor(csch(x), x, pi*i/2)
```

```
ans =  
(x - (pi*1i)/2)^2*1i)/2 - ((x - (pi*1i)/2)^4*5i)/24 - 1i
```

Rewrite the hyperbolic cosecant function in terms of the exponential function:

```
rewrite(csch(x), 'exp')
```

```
ans =  
-1/(exp(-x)/2 - exp(x)/2)
```

Input Arguments

X — Input

symbolic number | symbolic variable | symbolic expression | symbolic function | symbolic vector | symbolic matrix

Input, specified as a symbolic number, variable, expression, or function, or as a vector or matrix of symbolic numbers, variables, expressions, or functions.

See Also

acosh | acoth | acsch | asech | asinh | atanh | cosh | coth | sech | sinh | tanh

Introduced before R2006a

ctranspose, '

Symbolic matrix complex conjugate transpose

Syntax

```
A'  
ctranspose(A)
```

Description

A' computes the complex conjugate transpose on page 4-233 of A.

ctranspose(A) is equivalent to A'.

Examples

Conjugate Transpose of Real Matrix

Create a 2-by-3 matrix, the elements of which represent real numbers.

```
syms x y real  
A = [x x x; y y y]
```

```
A =  
[ x, x, x]  
[ y, y, y]
```

Find the complex conjugate transpose of this matrix.

```
A'  
  
ans =  
[ x, y]  
[ x, y]  
[ x, y]
```

If all elements of a matrix represent real numbers, then its complex conjugate transform equals to its nonconjugate transform.

```
isAlways(A' == A.')
```

```
ans =  
 3×2 logical array  
 1 1  
 1 1  
 1 1
```

Conjugate Transpose of Complex Matrix

Create a 2-by-2 matrix, the elements of which represent complex numbers.

```
syms x y real  
A = [x + y*i x - y*i; y + x*i y - x*i]
```

```
A =
[ x + y*1i, x - y*1i]
[ y + x*1i, y - x*1i]
```

Find the conjugate transpose of this matrix. The complex conjugate transpose operator, A' , performs a transpose and negates the sign of the imaginary portion of the complex elements in A .

A'

```
ans =
[ x - y*1i, y - x*1i]
[ x + y*1i, y + x*1i]
```

For a matrix of complex numbers with nonzero imaginary parts, the complex conjugate transform is not equal to the nonconjugate transform.

```
isAlways(A' == A.', 'Unknown', 'false')
```

```
ans =
 2x2 logical array
     0     0
     0     0
```

Input Arguments

A — Input

number | symbolic number | symbolic variable | symbolic expression | symbolic vector | symbolic matrix | symbolic multidimensional array

Input, specified as a number or a symbolic number, variable, expression, vector, matrix, multidimensional array.

More About

Complex Conjugate Transpose

The complex conjugate transpose of a matrix interchanges the row and column index for each element, reflecting the elements across the main diagonal. The operation also negates the imaginary part of any complex numbers.

For example, if $B = A'$ and $A(1,2)$ is $1+1i$, then the element $B(2,1)$ is $1-1i$.

See Also

ldivide | minus | mldivide | mpower | mrdivide | mtimes | plus | power | rdivide | times | transpose

Introduced before R2006a

cumprod

Symbolic cumulative product

Syntax

```
B = cumprod(A)
B = cumprod(A,dim)
B = cumprod( ____,direction)
```

Description

`B = cumprod(A)` returns an array the same size as `A` containing the cumulative product.

- If `A` is a vector, then `cumprod(A)` returns a vector containing the cumulative product of the elements of `A`.
- If `A` is a matrix, then `cumprod(A)` returns a matrix containing the cumulative products of each column of `A`.

`B = cumprod(A,dim)` returns the cumulative product along dimension `dim`. For example, if `A` is a matrix, then `cumprod(A,2)` returns the cumulative product of each row.

`B = cumprod(____,direction)` specifies the direction using any of the previous syntaxes. For instance, `cumprod(A,2,'reverse')` returns the cumulative product within the rows of `A` by working from end to beginning of the second dimension.

Examples

Cumulative Product of Vector

Create a vector and find the cumulative product of its elements.

```
V = 1./factorial(sym([1:5]))
prod_V = cumprod(V)

V =
[ 1, 1/2, 1/6, 1/24, 1/120]

prod_V =
[ 1, 1/2, 1/12, 1/288, 1/34560]
```

Cumulative Product of Each Column in Symbolic Matrix

Create matrix a 4-by-4 symbolic matrix `X` all elements of which equal `x`.

```
syms x
X = x*ones(4,4)

X =
[ x, x, x, x]
[ x, x, x, x]
[ x, x, x, x]
[ x, x, x, x]
```

Compute the cumulative product of the elements of X . By default, `cumprod` returns the cumulative product of each column.

```
productX = cumprod(X)
```

```
productX =
[  x,  x,  x,  x]
[ x^2, x^2, x^2, x^2]
[ x^3, x^3, x^3, x^3]
[ x^4, x^4, x^4, x^4]
```

Cumulative Product of Each Row in Symbolic Matrix

Create matrix a 4-by-4 symbolic matrix, all elements of which equal x .

```
syms x
X = x*ones(4,4)
```

```
X =
[ x, x, x, x]
[ x, x, x, x]
[ x, x, x, x]
[ x, x, x, x]
```

Compute the cumulative product of each row of the matrix X .

```
productX = cumprod(X,2)
```

```
productX =
[ x, x^2, x^3, x^4]
[ x, x^2, x^3, x^4]
[ x, x^2, x^3, x^4]
[ x, x^2, x^3, x^4]
```

Reverse Cumulative Product

Create matrix a 4-by-4 symbolic matrix X all elements of which equal x .

```
syms x
X = x*ones(4,4)
```

```
X =
[ x, x, x, x]
[ x, x, x, x]
[ x, x, x, x]
[ x, x, x, x]
```

Calculate the cumulative product along the columns in both directions. Specify the 'reverse' option to work from right to left in each row.

```
columnsDirect = cumprod(X)
columnsReverse = cumprod(X,'reverse')
```

```
columnsDirect =
[  x,  x,  x,  x]
[ x^2, x^2, x^2, x^2]
[ x^3, x^3, x^3, x^3]
[ x^4, x^4, x^4, x^4]
```

```
columnsReverse =
[ x^4, x^4, x^4, x^4]
[ x^3, x^3, x^3, x^3]
[ x^2, x^2, x^2, x^2]
[  x,  x,  x,  x]
```

Calculate the cumulative product along the rows in both directions. Specify the 'reverse' option to work from right to left in each row.

```
rowsDirect = cumprod(X,2)
rowsReverse = cumprod(X,2,'reverse')
```

```
rowsDirect =
[ x, x^2, x^3, x^4]
[ x, x^2, x^3, x^4]
[ x, x^2, x^3, x^4]
[ x, x^2, x^3, x^4]
```

```
rowsReverse =
[ x^4, x^3, x^2, x]
[ x^4, x^3, x^2, x]
[ x^4, x^3, x^2, x]
[ x^4, x^3, x^2, x]
```

Input Arguments

A — Input array

symbolic vector | symbolic matrix

Input array, specified as a vector or matrix.

dim — Dimension to operate along

positive integer

Dimension to operate along, specified as a positive integer. The default value is 1.

Consider a two-dimensional input array, A.

- `cumprod(A,1)` works on successive elements in the columns of A and returns the cumulative product of each column.
- `cumprod(A,2)` works on successive elements in the rows of A and returns the cumulative product of each row.

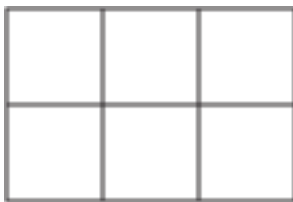

A

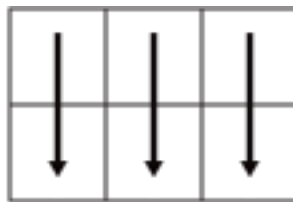

`cumprod(A,1)`

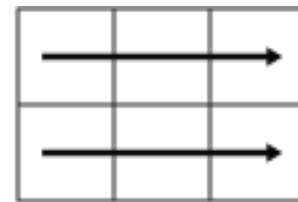

`cumprod(A,2)`

`cumprod` returns A if `dim` is greater than `ndims(A)`.

direction – Direction of cumulation`'forward'` (default) | `'reverse'`

Direction of cumulation, specified as the `'forward'` (default) or `'reverse'`.

- `'forward'` works from 1 to end of the active dimension.
- `'reverse'` works from end to 1 of the active dimension.

Output Arguments**B – Cumulative product array**`vector` | `matrix`

Cumulative product array, returned as a vector or matrix of the same size as the input A.

See Also`cumsum` | `fold` | `int` | `symprod` | `symsum`**Introduced in R2013b**

cumsum

Symbolic cumulative sum

Syntax

```
B = cumsum(A)
B = cumsum(A,dim)
B = cumsum( ____,direction)
```

Description

`B = cumsum(A)` returns an array the same size as `A` containing the cumulative sum.

- If `A` is a vector, then `cumsum(A)` returns a vector containing the cumulative sum of the elements of `A`.
- If `A` is a matrix, then `cumsum(A)` returns a matrix containing the cumulative sums of each column of `A`.

`B = cumsum(A,dim)` returns the cumulative sum along dimension `dim`. For example, if `A` is a matrix, then `cumsum(A,2)` returns the cumulative sum of each row.

`B = cumsum(____,direction)` specifies the direction using any of the previous syntaxes. For instance, `cumsum(A,2,'reverse')` returns the cumulative sum within the rows of `A` by working from end to beginning of the second dimension.

Examples

Cumulative Sum of Vector

Create a vector and find the cumulative sum of its elements.

```
V = 1./factorial(sym([1:5]))
sum_V = cumsum(V)
```

```
V =
[ 1, 1/2, 1/6, 1/24, 1/120]
```

```
sum_V =
[ 1, 3/2, 5/3, 41/24, 103/60]
```

Cumulative Sum of Each Column in Symbolic Matrix

Create matrix a 4-by-4 symbolic matrix `A` all elements of which equal 1.

```
A = sym(ones(4,4))
```

```
A =
[ 1, 1, 1, 1]
[ 1, 1, 1, 1]
[ 1, 1, 1, 1]
[ 1, 1, 1, 1]
```

Compute the cumulative sum of elements of A. By default, cumsum returns the cumulative sum of each column.

```
sumA = cumsum(A)
```

```
sumA =
[ 1, 1, 1, 1]
[ 2, 2, 2, 2]
[ 3, 3, 3, 3]
[ 4, 4, 4, 4]
```

Cumulative Sum of Each Row in Symbolic Matrix

Create matrix a 4-by-4 symbolic matrix A all elements of which equal 1.

```
A = sym(ones(4,4))
```

```
A =
[ 1, 1, 1, 1]
[ 1, 1, 1, 1]
[ 1, 1, 1, 1]
[ 1, 1, 1, 1]
```

Compute the cumulative sum of each row of the matrix A.

```
sumA = cumsum(A,2)
```

```
sumA =
[ 1, 2, 3, 4]
[ 1, 2, 3, 4]
[ 1, 2, 3, 4]
[ 1, 2, 3, 4]
```

Reverse Cumulative Sum

Create matrix a 4-by-4 symbolic matrix, all elements of which equal 1.

```
A = sym(ones(4,4))
```

```
A =
[ 1, 1, 1, 1]
[ 1, 1, 1, 1]
[ 1, 1, 1, 1]
[ 1, 1, 1, 1]
```

Calculate the cumulative sum along the columns in both directions. Specify the 'reverse' option to work from right to left in each row.

```
columnsDirect = cumsum(A)
columnsReverse = cumsum(A,'reverse')
```

```
columnsDirect =
[ 1, 1, 1, 1]
[ 2, 2, 2, 2]
[ 3, 3, 3, 3]
[ 4, 4, 4, 4]
```

```
columnsReverse =
[ 4, 4, 4, 4]
```

```
[ 3, 3, 3, 3]
[ 2, 2, 2, 2]
[ 1, 1, 1, 1]
```

Calculate the cumulative sum along the rows in both directions. Specify the 'reverse' option to work from right to left in each row.

```
rowsDirect = cumsum(A,2)
rowsReverse = cumsum(A,2,'reverse')
```

```
rowsDirect =
[ 1, 2, 3, 4]
[ 1, 2, 3, 4]
[ 1, 2, 3, 4]
[ 1, 2, 3, 4]
```

```
rowsReverse =
[ 4, 3, 2, 1]
[ 4, 3, 2, 1]
[ 4, 3, 2, 1]
[ 4, 3, 2, 1]
```

Input Arguments

A — Input array

symbolic vector | symbolic matrix

Input array, specified as a vector or matrix.

dim — Dimension to operate along

positive integer

Dimension to operate along, specified as a positive integer. The default value is 1.

Consider a two-dimensional input array, A:

- `cumsum(A,1)` works on successive elements in the columns of A and returns the cumulative sum of each column.
- `cumsum(A,2)` works on successive elements in the rows of A and returns the cumulative sum of each row.

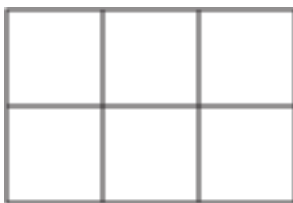

A

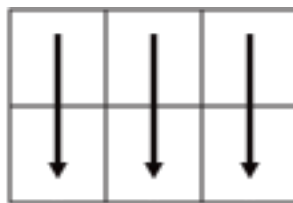

`cumsum(A,1)`

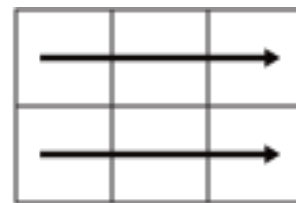

`cumsum(A,2)`

`cumsum` returns A if `dim` is greater than `ndims(A)`.

direction — Direction of cumulation

'forward' (default) | 'reverse'

Direction of cumulation, specified as the 'forward' (default) or 'reverse'.

- 'forward' works from 1 to end of the active dimension.
- 'reverse' works from end to 1 of the active dimension.

Output Arguments

B — Cumulative sum array

vector | matrix

Cumulative sum array, returned as a vector or matrix of the same size as the input A.

See Also

cumprod | fold | int | symprod | symsum

Introduced in R2013b

curl

Curl of vector field

Syntax

```
curl(V,X)
curl(V)
```

Description

`curl(V,X)` returns the curl of the vector field on page 4-243 V with respect to the vector X . The vector field V and the vector X are both three-dimensional.

`curl(V)` returns the curl of the vector field V with respect to the vector of variables returned by `symvar(V,3)`.

Examples

Compute Curl of Vector Field

Compute the curl of this vector field with respect to vector $X = (x, y, z)$ in Cartesian coordinates.

```
syms x y z
V = [x^3*y^2*z, y^3*z^2*x, z^3*x^2*y];
X = [x y z];
curl(V,X)
```

```
ans =
    x^2*z^3 - 2*x*y^3*z
    x^3*y^2 - 2*x*y*z^3
    - 2*x^3*y*z + y^3*z^2
```

Show Curl of Gradient of Scalar Function is Zero

Compute the curl of the gradient of this scalar function. The curl of the gradient of any scalar function is the vector of 0s.

```
syms x y z
f = x^2 + y^2 + z^2;
vars = [x y z];
curl(gradient(f,vars),vars)
```

```
ans =
    0
    0
    0
```

Compute Vector Laplacian of Vector Field

The vector Laplacian of a vector field V is defined as follows.

$$\nabla^2 V = \nabla(\nabla \cdot V) - \nabla \times (\nabla \times V)$$

Compute the vector Laplacian of this vector field using the `curl`, `divergence`, and `gradient` functions.

```
syms x y z
V = [x^2*y, y^2*z, z^2*x];
vars = [x y z];
gradient(divergence(V,vars)) - curl(curl(V,vars),vars)

ans =
 2*y
 2*z
 2*x
```

Input Arguments

V — Input

three-dimensional symbolic vector

Input, specified as a three-dimensional vector of symbolic expressions or symbolic functions.

X — Variables

vector of three variables

Variables, specified as a vector of three variables

More About

Curl of a Vector Field

The curl of the vector field $V = (V_1, V_2, V_3)$ with respect to the vector $X = (X_1, X_2, X_3)$ in Cartesian coordinates is this vector:

$$\text{curl}(V) = \nabla \times V = \begin{pmatrix} \frac{\partial V_3}{\partial X_2} - \frac{\partial V_2}{\partial X_3} \\ \frac{\partial V_1}{\partial X_3} - \frac{\partial V_3}{\partial X_1} \\ \frac{\partial V_2}{\partial X_1} - \frac{\partial V_1}{\partial X_2} \end{pmatrix}$$

See Also

`diff` | `divergence` | `gradient` | `hessian` | `jacobian` | `laplacian` | `potential` | `vectorPotential`

Introduced in R2012a

daeFunction

Convert system of differential algebraic equations to MATLAB function handle suitable for `ode15i`

Syntax

```
f = daeFunction(eqs,vars)
f = daeFunction(eqs,vars,p1,...,pN)
f = daeFunction( ___,Name,Value)
```

Description

`f = daeFunction(eqs,vars)` converts a system of symbolic first-order differential algebraic equations (DAEs) to a MATLAB function handle acceptable as an input argument to the numerical MATLAB DAE solver `ode15i`.

`f = daeFunction(eqs,vars,p1,...,pN)` lets you specify the symbolic parameters of the system as `p1,...,pN`.

`f = daeFunction(___,Name,Value)` uses additional options specified by one or more `Name,Value` pair arguments.

Examples

Convert DAE System to Function Handle

Create the system of differential algebraic equations. Here, the symbolic functions `x1(t)` and `x2(t)` represent the state variables of the system. The system also contains constant symbolic parameters `a`, `b`, and the parameter function `r(t)`. These parameters do not represent state variables. Specify the equations and state variables as two symbolic vectors: equations as a vector of symbolic equations, and variables as a vector of symbolic function calls.

```
syms x1(t) x2(t) a b r(t)
eqs = [diff(x1(t),t) == a*x1(t) + b*x2(t)^2,...
       x1(t)^2 + x2(t)^2 == r(t)^2];
vars = [x1(t), x2(t)];
```

Use `daeFunction` to generate a MATLAB function handle `f` depending on the variables `x1(t)`, `x2(t)` and on the parameters `a`, `b`, `r(t)`.

```
f = daeFunction(eqs, vars, a, b, r(t))
```

```
f =
function_handle with value:
    @(t,in2,in3,param1,param2,param3)[in3(1,)-param1.*in2(1,)...
-param2.*in2(2,).^2;-param3.^2+in2(1,).^2+in2(2,).^2]
```

Specify the parameter values, and create the reduced function handle `F` as follows.

```
a = -0.6;
b = -0.1;
```

```
r = @(t) cos(t)/(1 + t^2);
F = @(t, Y, YP) f(t,Y,YP,a,b,r(t));
```

Specify consistent initial conditions for the DAE system.

```
t0 = 0;
y0 = [-r(t0)*sin(0.1); r(t0)*cos(0.1)];
yp0= [a*y0(1) + b*y0(2)^2; 1.234];
```

Now, use `ode15i` to solve the system of equations.

```
ode15i(F, [t0, 1], y0, yp0)
```

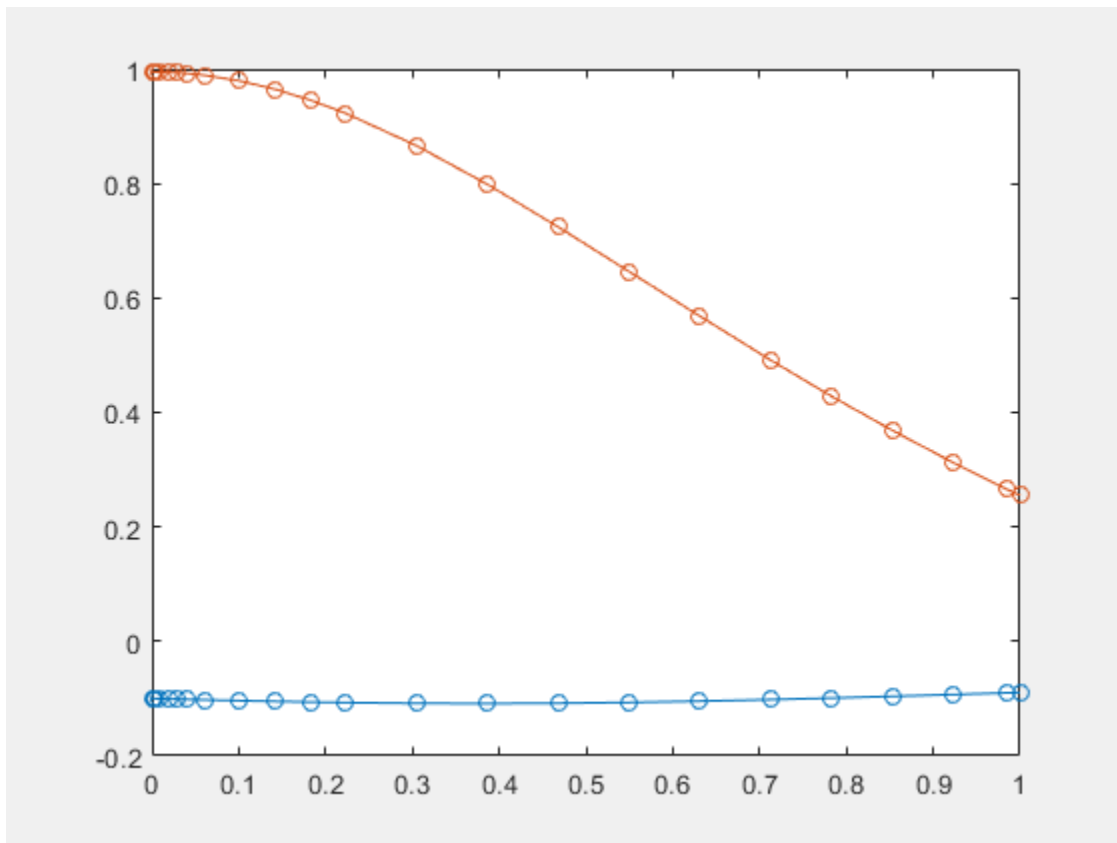

Write Function to File with Comments

Write the generated function handle to a file by specifying the `File` option. When writing to a file, `daeFunction` optimizes the code using intermediate variables named `t0`, `t1`, Include comments in the file using the `Comments` option.

Write the generated function handle to the file `myfile`.

```
syms x1(t) x2(t) a b r(t)
eqs = [diff(x1(t),t) == a*x1(t) + b*x2(t)^2,...
       x1(t)^2 + x2(t)^2 == r(t)^2];
vars = [x1(t), x2(t)];
daeFunction(eqs, vars, a, b, r(t), 'File', 'myfile')

function eqs = myfile(t,in2,in3,param1,param2,param3)
%MYFILE
```

```
% EQS = MYFILE(T,IN2,IN3,PARAM1,PARAM2,PARAM3)

% This function was generated by the Symbolic Math Toolbox version 7.3.
% 01-Jan-2017 00:00:00

YP1 = in3(1,:);
x1 = in2(1,:);
x2 = in2(2,:);
t2 = x2.^2;
eqs = [YP1-param2.*t2-param1.*x1;t2-param3.^2+x1.^2];
```

Include the comment **Version: 1.1.**

```
daeFunction(eqs, vars, a, b, r(t), 'File', 'myfile',...
            'Comments','Version: 1.1');

function eqs = myfile(t,in2,in3,param4,param5,param6)
...
%Version: 1.1
YP3 = in3(1,:);
...
```

Input Arguments

eqs — System of first-order DAEs

vector of symbolic equations | vector of symbolic expressions

System of first-order DAEs, specified as a vector of symbolic equations or expressions. Here, expressions represent equations with zero right side.

vars — State variables

vector of symbolic functions | vector of symbolic function calls

State variables, specified as a vector of symbolic functions or function calls, such as $x(t)$.

Example: $[x(t),y(t)]$ or $[x(t);y(t)]$

p1, ..., pN — Parameters of system

symbolic variables | symbolic functions | symbolic function calls | symbolic vector | symbolic matrix

Parameters of the system, specified as symbolic variables, functions, or function calls, such as $f(t)$. You can also specify parameters of the system as a vector or matrix of symbolic variables, functions, or function calls. If `eqs` contains symbolic parameters other than the variables specified in `vars`, you must specify these additional parameters as $p1, \dots, pN$.

Name-Value Pair Arguments

Specify optional comma-separated pairs of `Name, Value` arguments. `Name` is the argument name and `Value` is the corresponding value. `Name` must appear inside quotes. You can specify several name and value pair arguments in any order as `Name1, Value1, ..., NameN, ValueN`.

Example: `daeFunction(eqs,vars,'File','myfile')`

Comments — Comments to include in file header

character vector | cell array of character vectors | string vector

Comments to include in the file header, specified as a character vector, cell array of character vectors, or string vector.

File — Path to file containing generated code

character vector

Path to the file containing generated code, specified as a character vector. The generated file accepts arguments of type `double`, and can be used without Symbolic Math Toolbox. If the value is an empty character vector, `daeFunction` generates an anonymous function. If the character vector does not end in `.m`, the function appends `.m`.

By default, `daeFunction` with the `File` argument generates a file containing optimized code. Optimized means intermediate variables are automatically generated to simplify or speed up the code. MATLAB generates intermediate variables as a lowercase letter `t` followed by an automatically generated number, for example `t32`. To disable code optimization, use the `Optimize` argument.

Optimize — Flag preventing optimization of code written to function file

`true` (default) | `false`

Flag preventing optimization of code written to a function file, specified as `false` or `true`.

By default, `daeFunction` with the `File` argument generates a file containing optimized code. Optimized means intermediate variables are automatically generated to simplify or speed up the code. MATLAB generates intermediate variables as a lowercase letter `t` followed by an automatically generated number, for example `t32`.

`daeFunction` without the `File` argument (or with a file path specified by an empty character vector) creates a function handle. In this case, the code is not optimized. If you try to enforce code optimization by setting `Optimize` to `true`, then `daeFunction` throws an error.

Sparse — Flag that switches between sparse and dense matrix generation

`false` (default) | `true`

Flag that switches between sparse and dense matrix generation, specified as `true` or `false`. When you specify `'Sparse'`, `true`, the generated function represents symbolic matrices by sparse numeric matrices. Use `'Sparse'`, `true` when you convert symbolic matrices containing many zero elements. Often, operations on sparse matrices are more efficient than the same operations on dense matrices.

Output Arguments

f — Function handle that can serve as input argument to `ode15i`

MATLAB function handle

Function handle that can serve as input argument to `ode15i`, returned as a MATLAB function handle.

See Also

`decic` | `findDecoupledBlocks` | `incidenceMatrix` | `isLowIndexDAE` | `massMatrixForm` | `matlabFunction` | `ode15i` | `odeFunction` | `reduceDAEIndex` | `reduceDAEToODE` | `reduceDifferentialOrder` | `reduceRedundancies`

Topics

“Solve Differential Algebraic Equations (DAEs)” on page 2-194

Introduced in R2014b

dawson

Dawson integral

Syntax

`dawson(X)`

Description

`dawson(X)` represents the Dawson integral on page 4-251.

Examples

Dawson Integral for Numeric and Symbolic Arguments

Depending on its arguments, `dawson` returns floating-point or exact symbolic results.

Compute the Dawson integrals for these numbers. Because these numbers are not symbolic objects, `dawson` returns floating-point results.

```
A = dawson([-Inf, -3/2, -1, 0, 2, Inf])
```

```
A =
     0    -0.4282   -0.5381         0    0.3013         0
```

Compute the Dawson integrals for the numbers converted to symbolic objects. For many symbolic (exact) numbers, `dawson` returns unresolved symbolic calls.

```
symA = dawson(sym([-Inf, -3/2, -1, 0, 2, Inf]))
```

```
symA =
[ 0, -dawson(3/2), -dawson(1), 0, dawson(2), 0]
```

Use `vpa` to approximate symbolic results with floating-point numbers:

```
vpa(symA)
```

```
ans =
[ 0, ...
-0.42824907108539862547719010515175, ...
-0.53807950691276841913638742040756, ...
0, ...
0.30134038892379196603466443928642, ...
0]
```

Plot the Dawson Integral

Plot the Dawson integral on the interval from -10 to 10.

```
syms x
fplot(dawson(x), [-10 10])
grid on
```

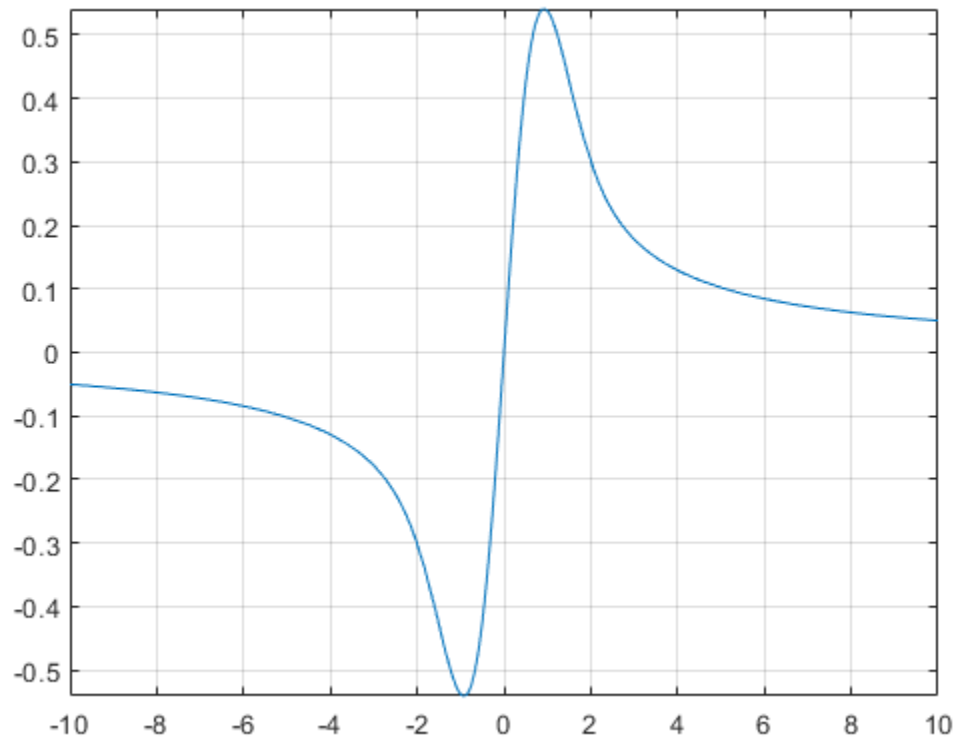

Handle Expressions Containing Dawson Integral

Many functions, such as `diff` and `limit`, can handle expressions containing `dawson`.

Find the first and second derivatives of the Dawson integral:

```
syms x
diff(dawson(x), x)
diff(dawson(x), x, x)
```

```
ans =
1 - 2*x*dawson(x)
```

```
ans =
2*x*(2*x*dawson(x) - 1) - 2*dawson(x)
```

Find the limit of this expression involving `dawson`:

```
limit(x*dawson(x), Inf)
```

```
ans =
1/2
```

Input Arguments

X — Input

symbolic number | symbolic variable | symbolic expression | symbolic function | symbolic vector | symbolic matrix

Input, specified as a symbolic number, variable, expression, or function, or as a vector or matrix of symbolic numbers, variables, expressions, or functions.

More About

Dawson Integral

The Dawson integral, also called the Dawson function, is defined as follows:

$$\text{dawson}(x) = D(x) = e^{-x^2} \int_0^x e^{t^2} dt$$

Symbolic Math Toolbox uses this definition to implement `dawson`.

The alternative definition of the Dawson integral is

$$D(x) = e^{x^2} \int_0^x e^{-t^2} dt$$

Tips

- `dawson(0)` returns 0.
- `dawson(Inf)` returns 0.
- `dawson(-Inf)` returns 0.

See Also

`erf` | `erfc`

Introduced in R2014a

```
str = dec2bin(d)

str = 4x7 char array
'1000000'
'0110110'
'1111011'
'0001011'
```

Return a binary representation with at least 8 digits by specifying the number of digits.

```
str = dec2bin(d,8)

str = 4x8 char array
'01000000'
'00110110'
'01111011'
'00001011'
```

Input Arguments

d — Decimal number

symbolic number | symbolic vector | symbolic matrix | symbolic array

Decimal number, specified as a symbolic number, vector, matrix, or array. **d** must be a nonnegative integer.

Example: `sym([2 4])`

n — Number of bits

scalar positive integer

Number of bits, specified as a scalar positive integer.

Example: 8

See Also

`dec2hex`

Introduced in R2019a

dec2hex

Convert decimal number to character vector representing hexadecimal number

Syntax

```
str = dec2hex(d)
str = dec2hex(d,n)
```

Description

`str = dec2hex(d)` returns the hexadecimal representation of symbolic number `d` as a character vector. `d` must be a nonnegative integer.

If `d` is a matrix or multidimensional array of symbolic numbers with `N` elements, `dec2hex` returns a character array with `N` rows. Each row of the output `str` corresponds to an element of `d` accessed with linear indexing.

`str = dec2hex(d,n)` returns a hexadecimal representation with at least `n` digits.

Examples

Convert Integer to Hexadecimal Representation

Define a large integer $2^{60} - 1$ as a symbolic number.

```
d = sym(2)^60 - 1
d = 1152921504606846975
```

Convert the decimal number to hexadecimal representation.

```
str = dec2hex(d)
str =
'FFFFFFFFFFFFFFFF'
```

Convert Array of Integers to Hexadecimal Representation

Create a 2-by-2 symbolic matrix that contains integers in decimal representation.

```
d = [sym(2)^6 123; 54 11]
d =
    (64 123)
    (54 11)
```

Convert the integers to hexadecimal representation using `dec2hex`. `dec2hex` returns 4 rows of character vectors. Each row contains a 2-digit hexadecimal number.

```
str = dec2hex(d)
str = 4x2 char array
    '40'
    '36'
    '7B'
    '0B'
```

Return a hexadecimal representation with at least 4 digits by specifying the number of digits.

```
str = dec2hex(d,4)
str = 4x4 char array
    '0040'
    '0036'
    '007B'
    '000B'
```

Input Arguments

d — Decimal number

symbolic number | symbolic vector | symbolic matrix | symbolic array

Decimal number, specified as a symbolic number, vector, matrix, or array. **d** must be a nonnegative integer.

Example: `sym([2 4])`

n — Number of hexadecimal digits

scalar positive integer

Number of hexadecimal digits, specified as a scalar positive integer.

Example: 8

See Also

`dec2bin`

Introduced in R2019a

decic

Find consistent initial conditions for first-order implicit ODE system with algebraic constraints

Syntax

```
[y0,yp0] = decic(eqs,vars,constraintEqs,t0,y0_est,fixedVars,yp0_est,options)
```

Description

`[y0,yp0] = decic(eqs,vars,constraintEqs,t0,y0_est,fixedVars,yp0_est,options)` finds consistent initial conditions for the system of first-order implicit ordinary differential equations with algebraic constraints returned by the `reduceDAEToODE` function.

The call `[eqs,constraintEqs] = reduceDAEToODE(DA_eqs,vars)` reduces the system of differential algebraic equations `DA_eqs` to the system of implicit ODEs `eqs`. It also returns constraint equations encountered during system reduction. For the variables of this ODE system and their derivatives, `decic` finds consistent initial conditions `y0, yp0` at the time `t0`.

Substituting the numerical values `y0, yp0` into the differential equations `subs(eqs, [t; vars(t); diff(vars(t))], [t0; y0; yp0])` and the constraint equations `subs(constr, [t; vars(t); diff(vars(t))], [t0; y0; yp0])` produces zero vectors. Here, `vars` must be a column vector.

`y0_est` specifies numerical estimates for the values of the variables `vars` at the time `t0`, and `fixedVars` indicates the values in `y0_est` that must not change during the numerical search. The optional argument `yp0_est` lets you specify numerical estimates for the values of the derivatives of the variables `vars` at the time `t0`.

Examples

Find Consistent Initial Conditions for ODE System

Reduce the DAE system to a system of implicit ODEs. Then, find consistent initial conditions for the variables of the resulting ODE system and their first derivatives.

Create the following differential algebraic system.

```
syms x(t) y(t)
DA_eqs = [diff(x(t),t) == cos(t) + y(t),...
          x(t)^2 + y(t)^2 == 1];
vars = [x(t); y(t)];
```

Use `reduceDAEToODE` to convert this system to a system of implicit ODEs.

```
[eqs, constraintEqs] = reduceDAEToODE(DA_eqs, vars)
```

```
eqs =
          diff(x(t), t) - y(t) - cos(t)
- 2*x(t)*diff(x(t), t) - 2*y(t)*diff(y(t), t)
```

```
constraintEqs =
1 - y(t)^2 - x(t)^2
```

Create an option set that specifies numerical tolerances for the numerical search.

```
options = odeset('RelTol', 10.0^(-7), 'AbsTol', 10.0^(-7));
```

Fix values $t_0 = 0$ for the time and numerical estimates for consistent values of the variables and their derivatives.

```
t0 = 0;
y0_est = [0.1, 0.9];
yp0_est = [0.0, 0.0];
```

You can treat the constraint as an algebraic equation for the variable x with the fixed parameter y . For this, set `fixedVars = [0 1]`. Alternatively, you can treat it as an algebraic equation for the variable y with the fixed parameter x . For this, set `fixedVars = [1 0]`.

First, set the initial value $x(t_0) = y_0_est(1) = 0.1$.

```
fixedVars = [1 0];
[y0, yp0] = decic(eqs, vars, constraintEqs, t0, y0_est, fixedVars, yp0_est, options)
```

```
y0 =
    0.1000
    0.9950
```

```
yp0 =
    1.9950
   -0.2005
```

Now, change `fixedVars` to `[0 1]`. This fixes $y(t_0) = y_0_est(2) = 0.9$.

```
fixedVars = [0 1];
[y0, yp0] = decic(eqs, vars, constraintEqs, t0, y0_est, fixedVars, yp0_est, options)
```

```
y0 =
   -0.4359
    0.9000
```

```
yp0 =
    1.9000
    0.9202
```

Verify that these initial values are consistent initial values satisfying the equations and the constraints.

```
subs(eqs, [t; vars; diff(vars,t)], [t0; y0; yp0])
```

```
ans =
    0
    0
```

```
subs(constraintEqs, [t; vars; diff(vars,t)], [t0; y0; yp0])
```

```
ans =
    0
```

Input Arguments

eqs — System of implicit ordinary differential equations

vector of symbolic equations | vector of symbolic expressions

System of implicit ordinary differential equations, specified as a vector of symbolic equations or expressions. Here, expressions represent equations with zero right side.

Typically, you use expressions returned by `reduceDAEToODE`.

vars — State variables of original DAE system

vector of symbolic functions | vector of symbolic function calls

State variables of original DAE system, specified as a vector of symbolic functions or function calls, such as $x(t)$.

Example: $[x(t), y(t)]$ or $[x(t); y(t)]$

constraintEqs — Constraint equations found by reduceDAEToODE during system reduction

vector of symbolic equations | vector of symbolic expressions

Constraint equations encountered during system reduction, specified as a vector of symbolic equations or expressions. These expressions or equations depend on the variables `vars`, but not on their derivatives.

Typically, you use constraint equations returned by `reduceDAEToODE`.

t0 — Initial time

number

Initial time, specified as a number.

y0_est — Estimates for values of variables vars at initial time t0

numeric vector

Estimates for the values of the variables `vars` at the initial time `t0`, specified as a numeric vector.

fixedVars — Input vector indicating which elements of y0_est are fixed values

vector with elements 0 or 1

Input vector indicating which elements of `y0_est` are fixed values, specified as a vector with 0s or 1s. Fixed values of `y0_est` correspond to values 1 in `fixedVars`. These values are not modified during the numerical search. The zero entries in `fixedVars` correspond to those variables in `y0_est` for which `decic` solves the constraint equations. The number of 0s must coincide with the number of constraint equations. The Jacobian matrix of the constraints with respect to the variables `vars(fixedVars == 0)` must be invertible.

yp0_est — Estimates for values of first derivatives of variables vars at initial time t0

numeric vector

Estimates for the values of the first derivatives of the variables `vars` at the initial time `t0`, specified as a numeric vector.

options — Options for numerical search

options structure, returned by `odeset`

Options for numerical search, specified as an options structure, returned by `odeset`. For example, you can specify tolerances for the numerical search here.

Output Arguments

y0 — Consistent initial values for variables

numeric column vector

Consistent initial values for variables, returned as a numeric column vector.

yp0 — Consistent initial values for first derivatives of variables

numeric column vector

Consistent initial values for first derivatives of variables, returned as a numeric column vector.

See Also

[daeFunction](#) | [findDecoupledBlocks](#) | [incidenceMatrix](#) | [isLowIndexDAE](#) | [massMatrixForm](#) | [odeFunction](#) | [reduceDAEIndex](#) | [reduceDAEToODE](#) | [reduceDifferentialOrder](#) | [reduceRedundancies](#)

Topics

“Solve Differential Algebraic Equations (DAEs)” on page 2-194

Introduced in R2014b

derivedUnits

Derived units of unit system

Syntax

```
derivedUnits(unitSystem)
```

Description

`derivedUnits(unitSystem)` returns the derived units of the unit system `unitSystem` as a vector of symbolic units. You can use the returned units to create new unit systems by using `newUnitSystem`.

Examples

Derived Units of Unit System

Get the derived units of a unit system by using `derivedUnits`. Then, modify the derived units and create a new unit system using the modified derived units. Available unit systems include SI, CGS, and US. For all unit systems, see “Unit Systems List” on page 2-36.

Get the derived units of the SI unit system.

```
dunits = derivedUnits('SI')

dunits =
[ [F], [C], [S], [H], [V], [J], [N], [lx], [lm], [Wb], [W], [Pa],...
  [Ohm], [T], [Gy], [Bq], [Sv], [Hz], [kat], [rad], [sr], [Celsius]]
```

Note Do not define a variable called `derivedUnits` because the variable will prevent access to the `derivedUnits` function.

Define derived units that use kilonewton for force and millibar for pressure by modifying `dunits` using `subs`.

```
u = symunit;
newUnits = subs(dunits,[u.N u.Pa],[u.kN u.mbar])

newUnits =
[ [F], [C], [S], [H], [V], [J], [kN], [lx], [lm], [Wb], [W], [mbar],...
  [Ohm], [T], [Gy], [Bq], [Sv], [Hz], [kat], [rad], [sr], [Celsius]]
```

Define the new unit system by using `newUnitSystem`. Keep the SI base units.

```
bunits = baseUnits('SI');
newUnitSystem('SI_kN_mbar',bunits,newUnits)

ans =
  "SI_kN_mbar"
```

To convert between unit systems, see “Unit Conversions and Unit Systems” on page 2-39.

Input Arguments

unitSystem — Name of unit system

string | character vector

Name of the unit system, specified as a string or character vector.

See Also

baseUnits | newUnitSystem | removeUnitSystem | rewrite | symunit | unitSystems

Topics

“Units of Measurement Tutorial” on page 2-19

“Unit Conversions and Unit Systems” on page 2-39

“Units and Unit Systems List” on page 2-25

External Websites

The International System of Units (SI)

Introduced in R2017b

det

Determinant of symbolic matrix

Syntax

```
B = det(A)
B = det(A, 'Algorithm', 'minor-expansion')
```

Description

`B = det(A)` returns the determinant of the square matrix `A`.

`B = det(A, 'Algorithm', 'minor-expansion')` uses the minor expansion algorithm to evaluate the determinant of `A`.

Examples

Compute Determinant of Symbolic Matrix

Compute the determinant of a symbolic matrix.

```
syms a b c d
M = [a b; c d];
B = det(M)
```

$B = ad - bc$

Compute Determinant of Matrix with Symbolic Numbers

Compute the determinant of a matrix that contain symbolic numbers.

```
A = sym([2/3 1/3; 1 1]);
B = det(A)
```

$B = \frac{1}{3}$

Compute Determinant Using Minor Expansion

Create a symbolic matrix that contains polynomial entries.

```
syms a x
A = [1, a*x^2+x, x;
     0, a*x, 2;
     3*x+2, a*x^2-1, 0]
```

$A =$

$$\begin{pmatrix} 1 & ax^2 + x & x \\ 0 & ax & 2 \\ 3x + 2 & ax^2 - 1 & 0 \end{pmatrix}$$

Compute the determinant of the matrix using minor expansion.

```
B = det(A, 'Algorithm', 'minor-expansion')
```

$$B = 3ax^3 + 6x^2 + 4x + 2$$

Input Arguments

A — Input matrix

square numeric matrix | square symbolic matrix

Input, specified as a square numeric or symbolic matrix.

Tips

- Matrix computations involving many symbolic variables can be slow. To increase the computational speed, reduce the number of symbolic variables by substituting the given values for some variables.
- The minor expansion method is generally useful to evaluate the determinant of a matrix that contains many symbolic variables. This method is often suited to matrices that contain polynomial entries with multivariate coefficients.

References

[1] Khovanova, T. and Z. Scully. "Efficient Calculation of Determinants of Symbolic Matrices with Many Variables." arXiv preprint arXiv:1304.4691 (2013).

See Also

eig | rank

Introduced before R2006a

diag

Create diagonal matrix or get diagonals from symbolic matrices

Syntax

```
D = diag(v)
D = diag(v,k)
```

```
x = diag(A)
x = diag(A,k)
```

Description

`D = diag(v)` returns a square diagonal matrix with vector `v` as the main diagonal.

`D = diag(v,k)` places vector `v` on the `k`th diagonal. `k = 0` represents the main diagonal, `k > 0` is above the main diagonal, and `k < 0` is below the main diagonal.

`x = diag(A)` returns the main diagonal of `A`.

`x = diag(A,k)` returns the `k`th diagonal of `A`.

Examples

Create Matrix with Diagonal as Vector

Create a symbolic matrix with the main diagonal specified by the vector `v`.

```
syms a b c
v = [a b c];
diag(v)
```

```
ans =
[ a, 0, 0]
[ 0, b, 0]
[ 0, 0, c]
```

Create Matrix with Subdiagonal as Vector

Create a symbolic matrix with the second diagonal below the main diagonal specified by the vector `v`.

```
syms a b c
v = [a b c];
diag(v,-2)
```

```
ans =
[ 0, 0, 0, 0, 0]
[ 0, 0, 0, 0, 0]
[ a, 0, 0, 0, 0]
```

```
[ 0, b, 0, 0, 0]
[ 0, 0, c, 0, 0]
```

Extract Diagonal from Matrix

Extract the main diagonal from a square matrix.

```
syms x y z
A = magic(3).*[x, y, z];
diag(A)
```

```
ans =
 8*x
 5*y
 2*z
```

Extract Superdiagonal from Matrix

Extract the first diagonal above the main diagonal.

```
syms x y z
A = magic(3).*[x, y, z];
diag(A,1)
```

```
ans =
  y
 7*z
```

Input Arguments

v — Diagonal elements

symbolic vector

Diagonal elements, specified as a symbolic vector. If v is a vector with N elements, then `diag(v,k)` is a square matrix of order $N + \text{abs}(k)$.

A — Input matrix

symbolic matrix

Input matrix, specified as a symbolic matrix.

k — Diagonal number

integer

Diagonal number, specified as an integer. $k = 0$ represents the main diagonal, $k > 0$ is above the main diagonal, and $k < 0$ is below the main diagonal.

Tips

- The trace of a matrix is equal to `sum(diag(A))`.

See Also

`tril` | `triu`

Introduced before R2006a

diff

Differentiate symbolic expression or function

Syntax

```
diff(F)
diff(F,var)
diff(F,n)
diff(F,var,n)
diff(F,var1,...,varN)
```

Description

`diff(F)` differentiates F with respect to the variable determined by `symvar(F,1)`.

`diff(F,var)` differentiates F with respect to the variable `var`.

`diff(F,n)` computes the n th derivative of F with respect to the variable determined by `symvar`.

`diff(F,var,n)` computes the n th derivative of F with respect to the variable `var`.

`diff(F,var1,...,varN)` differentiates F with respect to the variables `var1,...,varN`.

Examples

Differentiate Function

Find the derivative of the function $\sin(x^2)$.

```
syms f(x)
f(x) = sin(x^2);
df = diff(f,x)
```

```
df(x) =
2*x*cos(x^2)
```

Find the value of the derivative at $x = 2$. Convert the value to double.

```
df2 = df(2)
```

```
df2 =
4*cos(4)
```

```
double(df2)
```

```
ans =
-2.6146
```

Differentiation with Respect to Particular Variable

Find the first derivative of this expression:

```
syms x t
diff(sin(x*t^2))
```

```
ans =
t^2*cos(t^2*x)
```

Because you did not specify the differentiation variable, `diff` uses the default variable defined by `symvar`. For this expression, the default variable is `x`:

```
symvar(sin(x*t^2),1)
```

```
ans =
x
```

Now, find the derivative of this expression with respect to the variable `t`:

```
diff(sin(x*t^2),t)
```

```
ans =
2*t*x*cos(t^2*x)
```

Higher-Order Derivatives of Univariate Expression

Find the 4th, 5th, and 6th derivatives of this expression:

```
syms t
d4 = diff(t^6,4)
d5 = diff(t^6,5)
d6 = diff(t^6,6)
```

```
d4 =
360*t^2
```

```
d5 =
720*t
```

```
d6 =
720
```

Higher-Order Derivatives of Multivariate Expression with Respect to Particular Variable

Find the second derivative of this expression with respect to the variable `y`:

```
syms x y
diff(x*cos(x*y), y, 2)
```

```
ans =
-x^3*cos(x*y)
```

Higher-Order Derivatives of Multivariate Expression with Respect to Default Variable

Compute the second derivative of the expression `x*y`. If you do not specify the differentiation variable, `diff` uses the variable determined by `symvar`. For this expression, `symvar(x*y,1)` returns `x`. Therefore, `diff` computes the second derivative of `x*y` with respect to `x`.

```
syms x y
diff(x*y, 2)
```

```
ans =
0
```

If you use nested `diff` calls and do not specify the differentiation variable, `diff` determines the differentiation variable for each call. For example, differentiate the expression $x*y$ by calling the `diff` function twice:

```
diff(diff(x*y))
```

```
ans =
1
```

In the first call, `diff` differentiates $x*y$ with respect to x , and returns y . In the second call, `diff` differentiates y with respect to y , and returns 1 .

Thus, `diff(x*y, 2)` is equivalent to `diff(x*y, x, x)`, and `diff(diff(x*y))` is equivalent to `diff(x*y, x, y)`.

Mixed Derivatives

Differentiate this expression with respect to the variables x and y :

```
syms x y
diff(x*sin(x*y), x, y)
```

```
ans =
2*x*cos(x*y) - x^2*y*sin(x*y)
```

You also can compute mixed higher-order derivatives by providing all differentiation variables:

```
syms x y
diff(x*sin(x*y), x, x, x, y)
```

```
ans =
x^2*y^3*sin(x*y) - 6*x*y^2*cos(x*y) - 6*y*sin(x*y)
```

Input Arguments

F — Expression or function to differentiate

symbolic expression | symbolic function | symbolic vector | symbolic matrix

Expression or function to differentiate, specified as a symbolic expression or function or as a vector or matrix of symbolic expressions or functions. If F is a vector or a matrix, `diff` differentiates each element of F and returns a vector or a matrix of the same size as F .

var — Differentiation variable

symbolic variable

Differentiation variable, specified as a symbolic variable.

var1, ..., varN — Differentiation variables

symbolic variables

Differentiation variables, specified as symbolic variables.

n — Differentiation order

nonnegative integer

Differentiation order, specified as a nonnegative integer.

Tips

- When computing mixed higher-order derivatives, do not use `n` to specify the differentiation order. Instead, specify all differentiation variables explicitly.
- To improve performance, `diff` assumes that all mixed derivatives commute. For example,

$$\frac{\partial}{\partial x} \frac{\partial}{\partial y} f(x, y) = \frac{\partial}{\partial y} \frac{\partial}{\partial x} f(x, y)$$

This assumption suffices for most engineering and scientific problems.

- If you differentiate a multivariate expression or function `F` without specifying the differentiation variable, then a nested call to `diff` and `diff(F, n)` can return different results. This is because in a nested call, each differentiation step determines and uses its own differentiation variable. In calls like `diff(F, n)`, the differentiation variable is determined once by `symvar(F, 1)` and used for all differentiation steps.
- If you differentiate an expression or function containing `abs` or `sign`, ensure that the arguments are real values. For complex arguments of `abs` and `sign`, the `diff` function formally computes the derivative, but this result is not generally valid because `abs` and `sign` are not differentiable over complex numbers.

See Also

`curl` | `divergence` | `functionalDerivative` | `gradient` | `hessian` | `int` | `jacobian` | `laplacian` | `symvar`

Topics

“Differentiation” on page 2-46

“Find Asymptotes, Critical, and Inflection Points” on page 2-76

Introduced before R2006a

digits

Change variable precision used

Syntax

```
digits(d)
d1 = digits
d1 = digits(d)
```

Description

`digits(d)` sets the precision used by `vpa` to `d` significant decimal digits. The default is 32 digits.

`d1 = digits` returns the current precision used by `vpa`.

`d1 = digits(d)` sets the new precision `d` and returns the old precision in `d1`.

Examples

Increase Precision of Results

By default, MATLAB uses 16 digits of precision. For higher precision, use `vpa`. The default precision for `vpa` is 32 digits. Increase precision beyond 32 digits by using `digits`.

Find `pi` using `vpa`, which uses the default 32 digits of precision. Confirm that the current precision is 32 by using `digits`.

```
pi32 = vpa(pi)

pi32 =
3.1415926535897932384626433832795

currentPrecision = digits

currentPrecision =
    32
```

Save the current value of `digits` in `digitsOld` and set the new precision to 100 digits. Find `pi` using `vpa`. The result has 100 digits.

```
digitsOld = digits(100);
pi100 = vpa(pi)

pi100 =
3.1415926535897932384626433832795028841971693993751058209...
74944592307816406286208998628034825342117068
```

Note `vpa` output is symbolic. To use symbolic output with a MATLAB function that does not accept symbolic values, convert symbolic values to double precision by using `double`.

Lastly, restore the old value of `digits` for further calculations.

```
digits(digitsOld)
```

For more information, see “Increase Precision of Numeric Calculations” on page 2-128.

Increase Speed by Decreasing Precision

Increase the speed of MATLAB calculations by using `vpa` with a lower precision. Set the lower precision by using `digits`.

First, find the time taken to perform an operation on a large input.

```
input = 1:0.01:500;  
tic  
zeta(input);  
toc
```

```
Elapsed time is 48.968983 seconds.
```

Now, repeat the operation with a lower precision by using `vpa`. Lower the precision to 10 digits by using `digits`. Then, use `vpa` to reduce the precision of `input` and perform the same operation. The time taken decreases significantly.

```
digitsOld = digits(10);  
vpaInput = vpa(input);  
tic  
zeta(vpaInput);  
toc
```

```
Elapsed time is 31.450342 seconds.
```

Note `vpa` output is symbolic. To use symbolic output with a MATLAB function that does not accept symbolic values, convert symbolic values to double precision by using `double`.

Lastly, restore the old value of `digits` for further calculations.

```
digits(digitsOld)
```

For more information, see “Increase Speed by Reducing Precision” on page 2-134.

Guard Digits

The number of digits that you specify using the `vpa` function or the `digits` function is the guaranteed number of digits. Internally, the toolbox can use a few more digits than you specify. These additional digits are called guard digits. For example, set the number of digits to 4, and then display the floating-point approximation of $1/3$ using four digits:

```
old = digits(4);  
a = vpa(1/3)  
  
a =  
0.3333
```

Now, display `a` using 20 digits. The result shows that the toolbox internally used more than four digits when computing `a`. The last digits in the following result are incorrect because of the round-off error:

```
digits(20)
vpa(a)
digits(old)
```

```
ans =
0.3333333333333016843
```

Hidden Round-Off Errors

Hidden round-off errors can cause unexpected results. For example, compute the number 1/10 with the default 32-digit accuracy and with 10-digit accuracy:

```
a = vpa(1/10)
old = digits(10);
b = vpa(1/10)
digits(old)
```

```
a =
0.1
```

```
b =
0.1
```

Now, compute the difference $a - b$. The result is not 0:

```
a - b

ans =
0.00000000000000000000000086736173798840354720600815844403
```

The difference $a - b$ is not equal to zero because the toolbox internally boosts the 10-digit number $b = 0.1$ to 32-digit accuracy. This process implies round-off errors. The toolbox actually computes the difference $a - b$ as follows:

```
b = vpa(b)
a - b

b =
0.0999999999999999999999991326382620116

ans =
0.00000000000000000000000086736173798840354720600815844403
```

Techniques Used to Convert Floating-Point Numbers to Symbolic Objects

Suppose you convert a double number to a symbolic object, and then perform VPA operations on that object. The results can depend on the conversion technique that you used to convert a floating-point number to a symbolic object. The `sym` function lets you choose the conversion technique by specifying the optional second argument, which can be 'r', 'f', 'd', or 'e'. The default is 'r'. For example, convert the constant $\pi = 3.141592653589793\dots$ to a symbolic object:

```
r = sym(pi)
f = sym(pi, 'f')
d = sym(pi, 'd')
e = sym(pi, 'e')

r =
pi
```

```
f =  
884279719003555/281474976710656  
  
d =  
3.1415926535897931159979634685442  
  
e =  
pi - (198*eps)/359
```

Although the toolbox displays these numbers differently on the screen, they are rational approximations of π . Use `vpa` to convert these rational approximations of π back to floating-point values.

Set the number of digits to 4. Three of the four approximations give the same result.

```
digits(4)  
vpa(r)  
vpa(f)  
vpa(d)  
vpa(e)  
  
ans =  
3.142  
  
ans =  
3.142  
  
ans =  
3.142  
  
ans =  
3.142 - 0.5515*eps
```

Now, set the number of digits to 40. The differences between the symbolic approximations of π become more visible.

```
digits(40)  
vpa(r)  
vpa(f)  
vpa(d)  
vpa(e)  
  
ans =  
3.141592653589793238462643383279502884197  
  
ans =  
3.141592653589793115997963468544185161591  
  
ans =  
3.1415926535897931159979634685442  
  
ans =  
3.141592653589793238462643383279502884197 - ...  
0.5515320334261838440111420612813370473538*eps
```

Input Arguments

d — New accuracy setting

number | symbolic number

New accuracy setting, specified as a number or symbolic number. The setting specifies the number of significant decimal digits to be used for variable-precision calculations. If the value `d` is not an integer, `digits` rounds it to the nearest integer.

Output Arguments

d1 — Current accuracy setting

double-precision number

Current accuracy setting, returned as a double-precision number. The setting specifies the number of significant decimal digits currently used for variable-precision calculations.

See Also

`double` | `vpa`

Topics

“Increase Precision of Numeric Calculations” on page 2-128

“Recognize and Avoid Round-Off Errors” on page 2-130

“Increase Speed by Reducing Precision” on page 2-134

Introduced before R2006a

dilog

Dilogarithm function

Syntax

`dilog(X)`

Description

`dilog(X)` returns the dilogarithm function.

Examples

Dilogarithm Function for Numeric and Symbolic Arguments

Depending on its arguments, `dilog` returns floating-point or exact symbolic results.

Compute the dilogarithm function for these numbers. Because these numbers are not symbolic objects, `dilog` returns floating-point results.

```
A = dilog([-1, 0, 1/4, 1/2, 1, 2])
```

```
A =
    2.4674 - 2.1776i    1.6449 + 0.0000i    0.9785 + 0.0000i...
    0.5822 + 0.0000i    0.0000 + 0.0000i   -0.8225 + 0.0000i
```

Compute the dilogarithm function for the numbers converted to symbolic objects. For many symbolic (exact) numbers, `dilog` returns unresolved symbolic calls.

```
symA = dilog(sym([-1, 0, 1/4, 1/2, 1, 2]))
```

```
symA =
[ pi^2/4 - pi*log(2)*1i, pi^2/6, dilog(1/4), pi^2/12 - log(2)^2/2, 0, -pi^2/12]
```

Use `vpa` to approximate symbolic results with floating-point numbers:

```
vpa(symA)
```

```
ans =
[ 2.467401100272339654708622749969 - 2.1775860903036021305006888982376i,...
 1.644934066848226436472415166646,...
 0.97846939293030610374306666652456,...
 0.58224052646501250590265632015968,...
 0,...
 -0.82246703342411321823620758332301]
```

Plot Dilogarithm Function

Plot the dilogarithm function on the interval from 0 to 10.

```
syms x
fplot(dilog(x),[0 10])
grid on
```

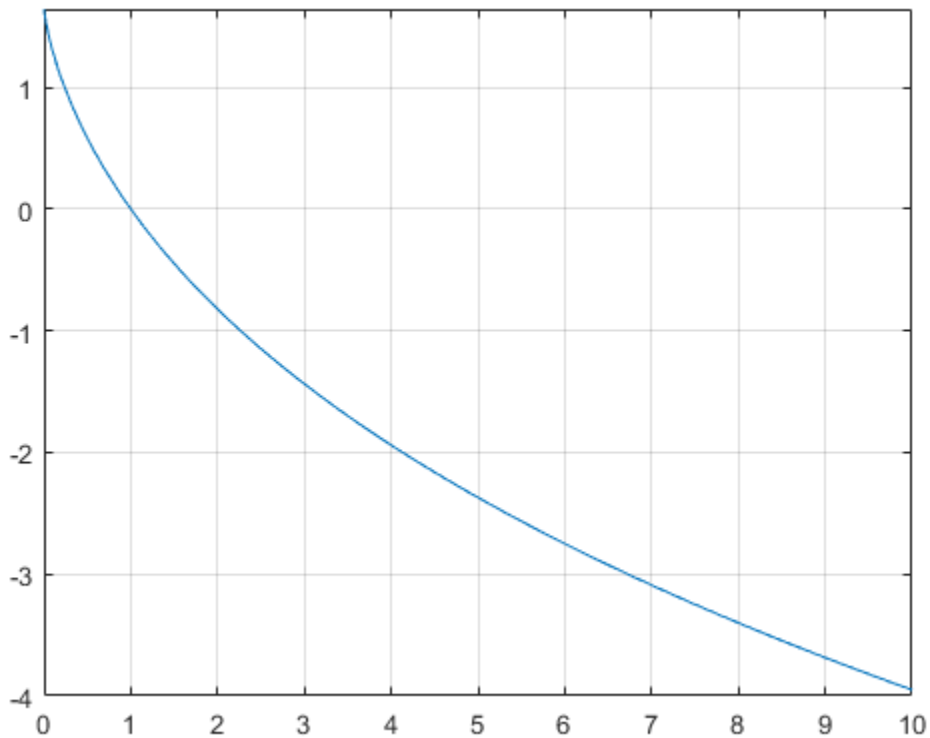

Handle Expressions Containing Dilogarithm Function

Many functions, such as `diff`, `int`, and `limit`, can handle expressions containing `dilog`.

Find the first and second derivatives of the dilogarithm function:

```
syms x
diff(dilog(x), x)
diff(dilog(x), x, x)
```

```
ans =
-log(x)/(x - 1)
```

```
ans =
log(x)/(x - 1)^2 - 1/(x*(x - 1))
```

Find the indefinite integral of the dilogarithm function:

```
int(dilog(x), x)
```

```
ans =
x*(dilog(x) + log(x) - 1) - dilog(x)
```

Find the limit of this expression involving `dilog`:

```
limit(dilog(x)/x, Inf)
```

```
ans =
0
```

Input Arguments

X — Input

symbolic number | symbolic variable | symbolic expression | symbolic function | symbolic vector | symbolic matrix

Input, specified as a symbolic number, variable, expression, or function, or as a vector or matrix of symbolic numbers, variables, expressions, or functions.

More About

Dilogarithm Function

There are two common definitions of the dilogarithm function.

The implementation of the `di log` function uses the following definition:

$$\operatorname{dilog}(x) = \int_1^x \frac{\ln(t)}{1-t} dt$$

Another common definition of the dilogarithm function is

$$\operatorname{Li}_2(x) = \int_x^0 \frac{\ln(1-t)}{t} dt$$

Thus, $\operatorname{dilog}(x) = \operatorname{Li}_2(1-x)$.

Tips

- `dilog(sym(-1))` returns $\pi^2/4 - \pi \cdot \log(2) \cdot i$.
- `dilog(sym(0))` returns $\pi^2/6$.
- `dilog(sym(1/2))` returns $\pi^2/12 - \log(2)^2/2$.
- `dilog(sym(1))` returns 0.
- `dilog(sym(2))` returns $-\pi^2/12$.
- `dilog(sym(i))` returns $\pi^2/16 - (\pi \cdot \log(2) \cdot i)/4 - \operatorname{catalan} \cdot i$.
- `dilog(sym(-i))` returns $\operatorname{catalan} \cdot i + (\pi \cdot \log(2) \cdot i)/4 + \pi^2/16$.
- `dilog(sym(1 + i))` returns $-\operatorname{catalan} \cdot i - \pi^2/48$.
- `dilog(sym(1 - i))` returns $\operatorname{catalan} \cdot i - \pi^2/48$.
- `dilog(sym(Inf))` returns $-\operatorname{Inf}$.

References

- [1] Stegun, I. A. "Miscellaneous Functions." *Handbook of Mathematical Functions with Formulas, Graphs, and Mathematical Tables*. (M. Abramowitz and I. A. Stegun, eds.). New York: Dover, 1972.

See Also

log | zeta

Introduced in R2014a

dirac

Dirac delta function

Syntax

```
d = dirac(x)
d = dirac(n,x)
```

Description

$d = \text{dirac}(x)$ represents the Dirac delta function on page 4-283 of x .

$d = \text{dirac}(n,x)$ represents the n th derivative of the Dirac delta function at x .

Examples

Handle Expressions Involving Dirac and Heaviside Functions

Compute derivatives and integrals of expressions involving the Dirac delta and Heaviside functions.

Find the first and second derivatives of the Heaviside function. The result is the Dirac delta function and its first derivative.

```
syms x
diff(heaviside(x), x)
diff(heaviside(x), x, x)
```

```
ans =
dirac(x)
```

```
ans =
dirac(1, x)
```

Find the indefinite integral of the Dirac delta function. The results returned by `int` do not include integration constants.

```
int(dirac(x), x)
```

```
ans =
sign(x)/2
```

Find the integral of the sine function involving the Dirac delta function.

```
syms a
int(dirac(x - a)*sin(x), x, -Inf, Inf)
```

```
ans =
sin(a)
```

Use Assumptions on Variables

`dirac` takes into account assumptions on variables.

```
syms x real
assumeAlso(x ~= 0)
dirac(x)
```

```
ans =
0
```

For further computations, clear the assumptions on x by recreating it using `syms`.

```
syms x
```

Evaluate Dirac Delta Function for Symbolic Matrix

Compute the Dirac delta function of x and its first three derivatives.

Use a vector $n = [0, 1, 2, 3]$ to specify the order of derivatives. The `dirac` function expands the scalar into a vector of the same size as n and computes the result.

```
syms x
n = [0,1,2,3];
d = dirac(n,x)

d =
[ dirac(x), dirac(1, x), dirac(2, x), dirac(3, x)]
```

Substitute x with 0 .

```
subs(d,x,0)

ans =
[ Inf, -Inf, Inf, -Inf]
```

Plot Dirac Delta Function

You can use `fplot` to plot the Dirac delta function over the default interval $[-5, 5]$. However, `dirac(x)` returns `Inf` at x equal to 0 , and `fplot` does not plot the infinity.

Declare a symbolic variable x and plot the symbolic expression `dirac(x)` by using `fplot`.

```
syms x
fplot(dirac(x))
```

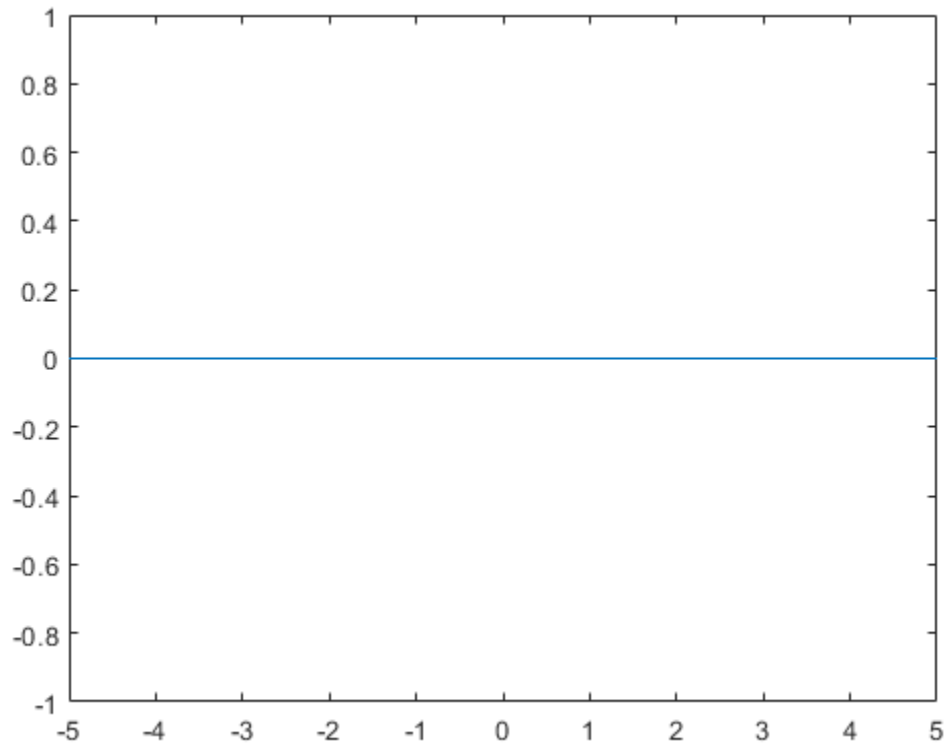

To handle the infinity at x equal to 0 , use numeric values instead of symbolic values. Set the `Inf` value to `1` and plot the Dirac delta function by using `stem`.

```
x = -1:0.1:1;
y = dirac(x);
idx = y == Inf; % find Inf
y(idx) = 1;     % set Inf to finite value
stem(x,y)
```

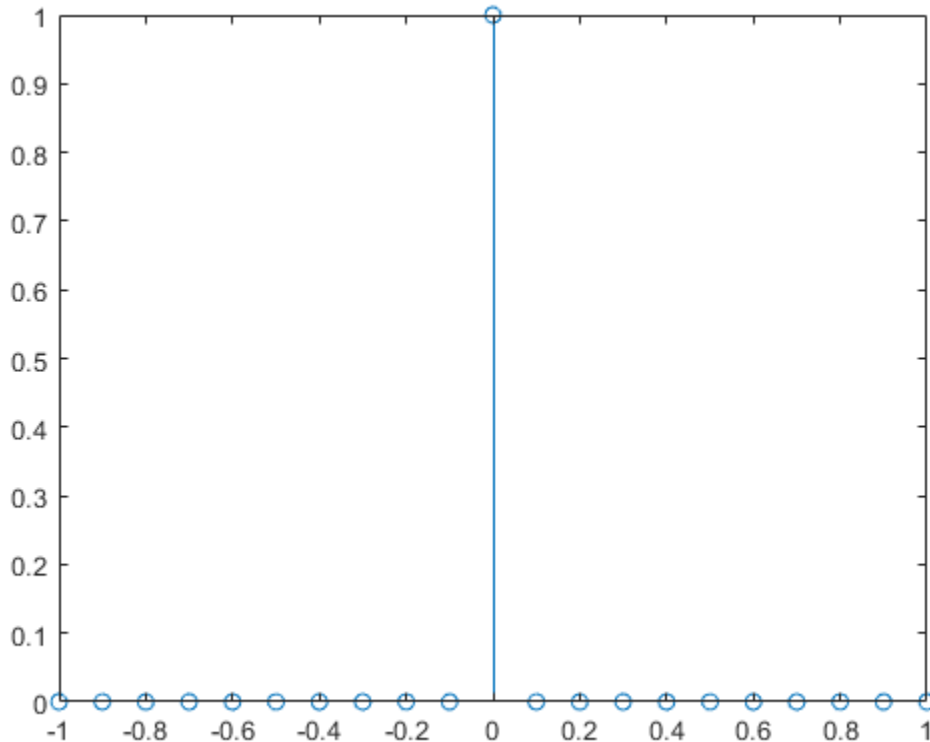
Input Arguments

x — Input

number | symbolic number | symbolic variable | symbolic expression | symbolic function | vector | matrix | multidimensional array

Input, specified as a number, symbolic number, variable, expression, or function, representing a real number. This input can also be a vector, matrix, or multidimensional array of numbers, symbolic numbers, variables, expressions, or functions.

n — Order of derivative

nonnegative number | symbolic variable | symbolic expression | symbolic function | vector | matrix | multidimensional array

Order of derivative, specified as a nonnegative number, or symbolic variable, expression, or function representing a nonnegative number. This input can also be a vector, matrix, or multidimensional array of nonnegative numbers, symbolic numbers, variables, expressions, or functions.

More About

Dirac Delta Function

The Dirac delta function, $\delta(x)$, has the value 0 for all $x \neq 0$, and ∞ for $x = 0$. The Dirac delta function satisfies the identity

$$\int_{-\infty}^{\infty} \delta(x) dx = 1 .$$

This is a heuristic definition of the Dirac delta function. A rigorous definition of the Dirac delta function requires the theory of distributions or measure theory.

For any smooth function f and a real number a , the Dirac delta function has the property

$$\int_{-\infty}^{\infty} \delta(x - a) f(x) = f(a) .$$

Tips

- For complex values x with nonzero imaginary parts, `dirac` returns `NaN`.
- `dirac` returns floating-point results for numeric arguments that are not symbolic objects.
- `dirac` acts element-wise on nonscalar inputs.
- The input arguments x and n must be vectors or matrices of the same size, or else one of them must be a scalar. If one input argument is a scalar and the other one is a vector or a matrix, then `dirac` expands the scalar into a vector or matrix of the same size as the other argument with all elements equal to that scalar.

See Also

`heaviside` | `kroneckerDelta`

Introduced before R2006a

displayFormula

Display symbolic formula from string

Syntax

```
displayFormula(symstr)
displayFormula(symstr,old,new)
```

Description

`displayFormula(symstr)` displays the symbolic formula from the string `symstr` without evaluating the operations. All workspace variables that are specified in `symstr` are replaced by their values.

`displayFormula(symstr,old,new)` replaces only the expression or variable `old` with `new`. Expressions or variables other than `old` are not replaced by their values.

Examples

Multiplication Formula of Matrix and Scalar

Create a 3-by-3 matrix. Multiply the matrix by the scalar coefficient K^2 .

```
syms K A
A = [-1, 0, 1; 1, 2, 0; 1, 1, 0];
B = K^2*A
```

$$B = \begin{pmatrix} -K^2 & 0 & K^2 \\ K^2 & 2K^2 & 0 \\ K^2 & K^2 & 0 \end{pmatrix}$$

The result automatically shows the multiplication being carried out element-wise.

Show the multiplication formula without evaluating the operations by using `displayFormula`. Input the formula as a string. The variable `A` in the string is replaced by its values.

```
displayFormula("F = K^2*A")
```

$$F = K^2 \begin{pmatrix} -1 & 0 & 1 \\ 1 & 2 & 0 \\ 1 & 1 & 0 \end{pmatrix}$$

Display Differential Equation

Define a string that describes a differential equation.

```
S = "m*diff(y,t,t) == m*g-k*y";
```

Create a string array that combines the differential equation and additional text. Display the formula along with the text.

```
symstr = ["The equation of motion is"; S; "where k is the elastic coefficient."];
displayFormula(symstr)
```

The equation of motion is

$$m \frac{\partial^2}{\partial t^2} y = m g - k y$$

where k is the elastic coefficient.

Display and Evaluate Symbolic Expression

Create a string S representing a symbolic expression.

```
S = "exp(2*pi*i)";
```

Create another string symstr that contains S.

```
symstr = "1 + S + S^2 + cos(S)";
```

```
symstr =
"1 + S + S^2 + cos(S)";
```

Display symstr as a formula without evaluating the operations by using displayFormula. S in symstr is replaced by its value.

```
displayFormula(symstr)
```

$$1 + e^{2\pi i} + (e^{2\pi i})^2 + \cos(e^{2\pi i})$$

To evaluate the strings S and symstr as symbolic expressions, use str2sym.

```
S = str2sym(S)
```

```
S = 1
```

```
expr = str2sym(symstr)
```

$$\text{expr} = S + \cos(S) + S^2 + 1$$

Substitute the variable S with its value by using subs. Evaluate the result in double precision using double.

```
double(subs(expr))
```

```
ans = 3.5403
```

Display and Solve Quadratic Equation

Define a string that represents a quadratic formula with the coefficients *a*, *b*, and *c*.

```
syms a b c k
symstr = "a*x^2 + b*x + c";
```

Display the quadratic formula, replacing *a* with *k*.

```
displayFormula(symstr,a,k)
```

$$kx^2 + bx + c$$

Display the quadratic formula again, replacing *a*, *b*, and *c* with 2, 3, and -1, respectively.

```
displayFormula(symstr,[a b c],[2 3 -1])
```

$$2x^2 + 3x - 1$$

To solve the quadratic equation, convert the string into a symbolic expression using `str2sym`. Use `solve` to find the zeros of the quadratic equation.

```
f = str2sym(symstr);
sol = solve(f)
```

$$\text{sol} = \begin{pmatrix} -\frac{b + \sqrt{b^2 - 4ac}}{2a} \\ -\frac{b - \sqrt{b^2 - 4ac}}{2a} \end{pmatrix}$$

Use `subs` to replace *a*, *b*, and *c* in the solution with 2, 3, and -1, respectively.

```
solValues = subs(sol,[a b c],[2 3 -1])
```

$$\text{solValues} = \begin{pmatrix} -\frac{\sqrt{17}}{4} - \frac{3}{4} \\ \frac{\sqrt{17}}{4} - \frac{3}{4} \end{pmatrix}$$

Input Arguments

symstr — String representing symbolic formula

character vector | string scalar | cell array of character vectors | string array

String representing a symbolic formula, specified as a character vector, string scalar, cell array of character vectors, or string array.

You can also combine a string that represents a symbolic formula with regular text (enclosed in single quotation marks) as a string array. For an example, see “Display Differential Equation” on page 4-285.

old — Expression or variable to be replaced

character vector | string scalar | cell array of character vectors | string array | symbolic variable | symbolic function | symbolic expression | symbolic array

Expression or variable to be replaced, specified as a character vector, string scalar, cell array of character vectors, string array, symbolic variable, function, expression, or array.

new — New value

number | character vector | string scalar | cell array of character vectors | string array | symbolic number | symbolic variable | symbolic expression | symbolic array

New value, specified as a number, character vector, string scalar, cell array of character vectors, string array, symbolic number, variable, expression, or array.

See Also

`solve` | `str2sym` | `subs` | `sym` | `syms`

Introduced in R2019b

divergence

Divergence of vector field

Syntax

`divergence(V,X)`

Description

`divergence(V,X)` returns the divergence of vector field on page 4-289 V with respect to the vector X in Cartesian coordinates. Vectors V and X must have the same length.

Examples

Find Divergence of Vector Field

Find the divergence of the vector field $V(x,y,z) = (x, 2y^2, 3z^3)$ with respect to vector $X = (x,y,z)$.

```
syms x y z
field = [x 2*y^2 3*z^3];
vars = [x y z];
divergence(field,vars)
```

```
ans =
9*z^2 + 4*y + 1
```

Show that the divergence of the curl of the vector field is 0.

```
divergence(curl(field,vars),vars)
```

```
ans =
0
```

Find the divergence of the gradient of this scalar function. The result is the Laplacian of the scalar function.

```
syms x y z
f = x^2 + y^2 + z^2;
divergence(gradient(f,vars),vars)
```

```
ans =
6
```

Find Electric Charge Density from Electric Field

Gauss' Law in differential form states that the divergence of electric field is proportional to the electric charge density.

$$\vec{\nabla} \cdot \vec{E}(\vec{r}) = \frac{\rho(\vec{r})}{\epsilon_0}.$$

Find the electric charge density for the electric field $\vec{E} = x^2\vec{i} + y^2\vec{j}$.

```
syms x y ep0
E = [x^2 y^2];
rho = ep0*divergence(E,[x y])
```

```
rho =
ep0*(2*x + 2*y)
```

Visualize the electric field and electric charge density for $-2 < x < 2$ and $-2 < y < 2$ with $\text{ep0}=1$. Create a grid of values of x and y using `meshgrid`. Find the values of electric field and charge density by substituting grid values using `subs`. Simultaneously substitute the grid values `xPlot` and `yPlot` into the charge density `rho` by using cells arrays as inputs to `subs`.

```
rho = subs(rho,ep0,1);
v = -2:0.1:2;
[xPlot,yPlot] = meshgrid(v);
Ex = subs(E(1),x,xPlot);
Ey = subs(E(2),y,yPlot);
rhoPlot = double(subs(rho,{x,y},{xPlot,yPlot}));
```

Plot the electric field using `quiver`. Overlay the charge density using `contour`. The contour lines indicate the values of the charge density.

```
quiver(xPlot,yPlot,Ex,Ey)
hold on
contour(xPlot,yPlot,rhoPlot,'ShowText','on')
title('Contour Plot of Charge Density Over Electric Field')
xlabel('x')
ylabel('y')
```

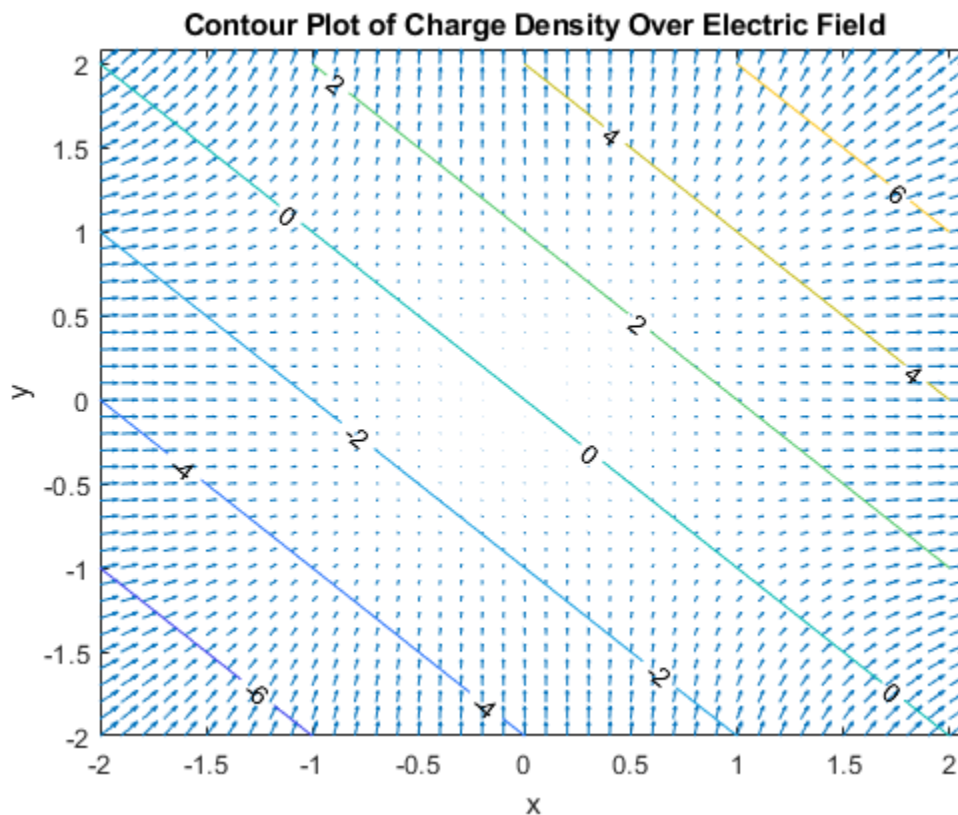
Input Arguments

V – Vector field

symbolic expression | symbolic function | vector of symbolic expressions | vector of symbolic functions

Vector field to find divergence of, specified as a symbolic expression or function, or as a vector of symbolic expressions or functions. V must be the same length as X.

X – Variables with respect to which you find the divergence

symbolic variable | vector of symbolic variables

Variables with respect to which you find the divergence, specified as a symbolic variable or a vector of symbolic variables. X must be the same length as V.

More About

Divergence of Vector Field

The divergence of the vector field $V = (V_1, \dots, V_n)$ with respect to the vector $X = (X_1, \dots, X_n)$ in Cartesian coordinates is the sum of partial derivatives of V with respect to X_1, \dots, X_n .

$$\text{div}(\vec{V}) = \nabla \cdot \vec{V} = \sum_{i=1}^n \frac{\partial V_i}{\partial X_i}.$$

See Also

`curl` | `diff` | `gradient` | `hessian` | `jacobian` | `laplacian` | `potential` | `vectorPotential`

Introduced in R2012a

divisors

Divisors of integer or expression

Syntax

```
divisors(n)
divisors(expr, vars)
```

Description

`divisors(n)` finds all nonnegative divisors of an integer n .

`divisors(expr, vars)` finds the divisors of a polynomial expression `expr`. Here, `vars` are polynomial variables.

Examples

Divisors of Integers

Find all nonnegative divisors of these integers.

Find the divisors of integers. You can use double precision numbers or numbers converted to symbolic objects. If you call `divisors` for a double-precision number, then it returns a vector of double-precision numbers.

```
divisors(42)

ans =
     1     2     3     6     7    14    21    42
```

Find the divisors of negative integers. `divisors` returns nonnegative divisors for negative integers.

```
divisors(-42)

ans =
     1     2     3     6     7    14    21    42
```

If you call `divisors` for a symbolic number, it returns a symbolic vector.

```
divisors(sym(42))

ans =
 [ 1, 2, 3, 6, 7, 14, 21, 42]
```

The only divisor of 0 is 0.

```
divisors(0)

ans =
     0
```

Divisors of Univariate Polynomials

Find the divisors of univariate polynomial expressions.

Find the divisors of this univariate polynomial. You can specify the polynomial as a symbolic expression.

```
syms x
divisors(x^4 - 1, x)

ans =
[ 1, x - 1, x + 1, (x - 1)*(x + 1), x^2 + 1, (x^2 + 1)*(x - 1), ...
(x^2 + 1)*(x + 1), (x^2 + 1)*(x - 1)*(x + 1)]
```

You also can use a symbolic function to specify the polynomial.

```
syms f(t)
f(t) = t^5;
divisors(f,t)

ans(t) =
[ 1, t, t^2, t^3, t^4, t^5]
```

When finding the divisors of a polynomial, `divisors` does not return the divisors of the constant factor.

```
f(t) = 9*t^5;
divisors(f,t)

ans(t) =
[ 1, t, t^2, t^3, t^4, t^5]
```

Divisors of Multivariate Polynomials

Find the divisors of multivariate polynomial expressions.

Find the divisors of the multivariate polynomial expression. Suppose that u and v are variables, and a is a symbolic parameter. Specify the variables as a symbolic vector.

```
syms a u v
divisors(a*u^2*v^3, [u,v])

ans =
[ 1, u, u^2, v, u*v, u^2*v, v^2, u*v^2, u^2*v^2, v^3, u*v^3, u^2*v^3]
```

Now, suppose that this expression contains only one variable (for example, v), while a and u are symbolic parameters. Here, `divisors` treats the expression $a*u^2$ as a constant and ignores it, returning only the divisors of v^3 .

```
divisors(a*u^2*v^3, v)

ans =
[ 1, v, v^2, v^3]
```

Input Arguments

n — Number for which to find divisors

number | symbolic number

Number for which to find the divisors, specified as a number or symbolic number.

expr — Polynomial expression for which to find divisors

symbolic expression | symbolic function

Polynomial expression for which to find divisors, specified as a symbolic expression or symbolic function.

vars — Polynomial variables

symbolic variable | vector of symbolic variables

Polynomial variables, specified as a symbolic variable or a vector of symbolic variables.

Tips

- `divisors(0)` returns 0.
- `divisors(expr,vars)` does not return the divisors of the constant factor when finding the divisors of a polynomial.
- If you do not specify polynomial variables, `divisors` returns as many divisors as it can find, including the divisors of constant symbolic expressions. For example, `divisors(sym(pi)^2*x^2)` returns [1, pi, pi^2, x, pi*x, pi^2*x, x^2, pi*x^2, pi^2*x^2] while `divisors(sym(pi)^2*x^2, x)` returns [1, x, x^2].
- For rational numbers, `divisors` returns all divisors of the numerator divided by all divisors of the denominator. For example, `divisors(sym(9/8))` returns [1, 3, 9, 1/2, 3/2, 9/2, 1/4, 3/4, 9/4, 1/8, 3/8, 9/8].

See Also

`coeffs` | `factor` | `numden`

Introduced in R2014b

double

Convert symbolic values to MATLAB double precision

Syntax

```
double(s)
```

Description

`double(s)` converts the symbolic value `s` to double precision. Converting symbolic values to double precision is useful when a MATLAB function does not accept symbolic values. For differences between symbolic and double-precision numbers, see “Choose Numeric or Symbolic Arithmetic” on page 2-124.

Examples

Convert Symbolic Number to Double Precision

Convert symbolic numbers to double precision by using `double`. Symbolic numbers are exact while double-precision numbers have round-off errors.

Convert `pi` and `1/3` from symbolic form to double precision.

```
symN = sym([pi 1/3])  
  
symN =  
[ pi, 1/3]  
  
doubleN = double(symN)  
  
doubleN =  
    3.1416    0.3333
```

For information on round-off errors, see “Recognize and Avoid Round-Off Errors” on page 2-130.

Convert Variable Precision to Double Precision

Variable-precision numbers created by `vpa` are symbolic values. When a MATLAB function does not accept symbolic values, convert variable precision to double precision by using `double`.

Convert `pi` and `1/3` from variable-precision form to double precision.

```
vpaN = vpa([pi 1/3])  
  
vpaN =  
[ 3.1415926535897932384626433832795, 0.33333333333333333333333333333333]  
  
doubleN = double(vpaN)  
  
doubleN =  
    3.1416    0.3333
```

Convert Symbolic Matrix to Double-Precision Matrix

Convert the symbolic numbers in matrix `symM` to double-precision numbers by using `double`.

```
a = sym(sqrt(2));
b = sym(2/3);
symM = [a b; a*b b/a]

symM =
[ 2^(1/2), 2/3]
[ (2*2^(1/2))/3, 2^(1/2)/3]

doubleM = double(symM)

doubleM =
    1.4142    0.6667
    0.9428    0.4714
```

High-Precision Conversion

When converting symbolic expressions that suffer from internal cancelation or round-off errors, increase the working precision by using `digits` before converting the number.

Convert a numerically unstable expression `Y` with `double`. Then, increase precision to 100 digits by using `digits` and convert `Y` again. This high-precision conversion is accurate while the low-precision conversion is not.

```
Y = ((exp(sym(200)) + 1)/(exp(sym(200)) - 1)) - 1;
lowPrecisionY = double(Y)

lowPrecisionY =
    0

digitsOld = digits(100);
highPrecisionY = double(Y)

highPrecisionY =
    2.7678e-87
```

Restore the old precision used by `digits` for further calculations.

```
digits(digitsOld)
```

Input Arguments

s — Symbolic input

symbolic number | vector of symbolic numbers | matrix of symbolic numbers | multidimensional array of symbolic numbers

Symbolic input, specified as a symbolic number, or a vector, matrix, or multidimensional array of symbolic numbers.

See Also

`sym` | `vpa`

Topics

“Choose Numeric or Symbolic Arithmetic” on page 2-124

“Increase Precision of Numeric Calculations” on page 2-128

“Recognize and Avoid Round-Off Errors” on page 2-130

“Increase Speed by Reducing Precision” on page 2-134

Introduced before R2006a

dsolve

Solve system of differential equations

Note Support for character vector or string inputs will be removed in a future release. Instead, use `syms` to declare variables and replace inputs such as `dsolve('Dy = y')` with `syms y(t); dsolve(diff(y,t) == y)`.

Syntax

```
S = dsolve(eqn)
S = dsolve(eqn,cond)
S = dsolve( ___,Name,Value)

[y1,...,yN] = dsolve( ___ )
```

Description

`S = dsolve(eqn)` solves the differential equation `eqn`, where `eqn` is a symbolic equation. Use `diff` and `==` to represent differential equations. For example, `diff(y,x) == y` represents the equation $dy/dx = y$. Solve a system of differential equations by specifying `eqn` as a vector of those equations.

`S = dsolve(eqn,cond)` solves `eqn` with the initial or boundary condition `cond`.

`S = dsolve(___,Name,Value)` uses additional options specified by one or more `Name,Value` pair arguments.

`[y1,...,yN] = dsolve(___)` assigns the solutions to the variables `y1,...,yN`.

Examples

Solve Differential Equation

Solve the first-order differential equation $\frac{dy}{dt} = ay$.

Specify the first-order derivative by using `diff` and the equation by using `==`. Then, solve the equation by using `dsolve`.

```
syms y(t) a
eqn = diff(y,t) == a*y;
S = dsolve(eqn)
```

$$S = C_1 e^{at}$$

The solution includes a constant. To eliminate constants, see “Solve Differential Equations with Conditions” on page 4-300. For a full workflow, see “Solving Partial Differential Equations”.

Solve Second-Order Differential Equation

Solve the second-order differential equation $\frac{d^2y}{dt^2} = ay$.

Specify the second-order derivative of y by using `diff(y,t,2)` and the equation by using `==`. Then, solve the equation by using `dsolve`.

```
syms y(t) a
eqn = diff(y,t,2) == a*y;
ySol(t) = dsolve(eqn)
```

$$ySol(t) = C_1 e^{-\sqrt{a}t} + C_2 e^{\sqrt{a}t}$$

Solve Differential Equations with Conditions

Solve the first-order differential equation $\frac{dy}{dt} = ay$ with the initial condition $y(0) = 5$.

Specify the initial condition as the second input to `dsolve` by using the `==` operator. Specifying condition eliminates arbitrary constants, such as C_1, C_2, \dots , from the solution.

```
syms y(t) a
eqn = diff(y,t) == a*y;
cond = y(0) == 5;
ySol(t) = dsolve(eqn,cond)
```

$$ySol(t) = 5 e^{at}$$

Next, solve the second-order differential equation $\frac{d^2y}{dt^2} = a^2y$ with the initial conditions $y(0) = b$ and $y'(0) = 1$.

Specify the second initial condition by assigning `diff(y,t)` to `Dy` and then using `Dy(0) == 1`.

```
syms y(t) a b
eqn = diff(y,t,2) == a^2*y;
Dy = diff(y,t);
cond = [y(0)==b, Dy(0)==1];
ySol(t) = dsolve(eqn,cond)
```

$$ySol(t) = \frac{e^{at}(ab+1)}{2a} + \frac{e^{-at}(ab-1)}{2a}$$

This second-order differential equation has two specified conditions, so constants are eliminated from the solution. In general, to eliminate constants from the solution, the number of conditions must equal the order of the equation.

Solve System of Differential Equations

Solve the system of differential equations

$$\frac{dy}{dt} = z$$

$$\frac{dz}{dt} = -y.$$

Specify the system of equations as a vector. `dsolve` returns a structure containing the solutions.

```
syms y(t) z(t)
eqns = [diff(y,t) == z, diff(z,t) == -y];
S = dsolve(eqns)
```

```
S = struct with fields:
  z: [1x1 sym]
  y: [1x1 sym]
```

Access the solutions by addressing the elements of the structure.

```
ySol(t) = S.y
```

```
ySol(t) = C1*cos(t) + C2*sin(t)
```

```
zSol(t) = S.z
```

```
zSol(t) = C2*cos(t) - C1*sin(t)
```

Assign Outputs to Functions or Variables

When solving for multiple functions, `dsolve` returns a structure by default. Alternatively, you can assign solutions to functions or variables directly by explicitly specifying the outputs as a vector. `dsolve` sorts the outputs in alphabetical order using `symvar`.

Solve a system of differential equations and assign the outputs to functions.

```
syms y(t) z(t)
eqns = [diff(y,t)==z, diff(z,t)==-y];
[ySol(t),zSol(t)] = dsolve(eqns)
```

```
ySol(t) = C1*cos(t) + C2*sin(t)
```

```
zSol(t) = C2*cos(t) - C1*sin(t)
```

Find Explicit and Implicit Solutions of Differential Equation

Solve the differential equation $\frac{\partial}{\partial t}y(t) = e^{-y(t)} + y(t)$. `dsolve` returns an explicit solution in terms of a Lambert W function that has a constant value.

```
syms y(t)
eqn = diff(y) == y+exp(-y)
```

```
eqn(t) =

$$\frac{\partial}{\partial t} y(t) = e^{-y(t)} + y(t)$$

```

```
sol = dsolve(eqn)
```

```
sol = W0(-1)
```

To return implicit solutions of the differential equation, set the 'Implicit' option to true. An implicit solution has the form $F(y(t)) = g(t)$.

```
sol = dsolve(eqn, 'Implicit', true)
```

```
sol =

$$\left( \left( \int \frac{e^y}{y e^y + 1} dy \Big|_{y=y(t)} \right) = C_1 + t \right)$$

$$e^{-y(t)} (e^{y(t)} y(t) + 1) = 0$$

```

Find Implicit Solution When No Explicit Solution Is Found

If `dsolve` cannot find an explicit solution of a differential equation analytically, then it returns an empty symbolic array. You can solve the differential equation by using MATLAB® numerical solver, such as `ode45`. For more information, see “Solve a Second-Order Differential Equation Numerically” on page 2-157.

```
syms y(x)
eqn = diff(y) == (x-exp(-x))/(y(x)+exp(y(x)));
S = dsolve(eqn)
```

```
Warning: Unable to find symbolic solution.
```

```
S =
```

```
[ empty sym ]
```

Alternatively, you can try finding an implicit solution of the differential equation by specifying the 'Implicit' option to true. An implicit solution has the form $F(y(x)) = g(x)$.

```
S = dsolve(eqn, 'Implicit', true)
```

```
S =

$$e^{y(x)} + \frac{y(x)^2}{2} = C_1 + e^{-x} + \frac{x^2}{2}$$

```

Include Special Cases by Turning Off Internal Simplifications

Solve the differential equation $\frac{dy}{dt} = \frac{a}{\sqrt{y}} + y$ with condition $y(a) = 1$. By default, `dsolve` applies simplifications that are not generally correct, but produce simpler solutions. For more details, see “Algorithms” on page 4-307.

```
syms a y(t)
eqn = diff(y) == a/sqrt(y) + y;
cond = y(a) == 1;
ySimplified = dsolve(eqn, cond)
```

$$ySimplified = \left(e^{\frac{3t}{2} - \frac{3a}{2} + \log(a+1)} - a \right)^{2/3}$$

To return the solutions that include all possible values of the parameter a , turn off simplifications by setting 'IgnoreAnalyticConstraints' to false.

```
yNotSimplified = dsolve(eqn, cond, 'IgnoreAnalyticConstraints', false)
```

```
yNotSimplified =
```

$$\left\{ \begin{array}{ll} \{\sigma_1\} & \text{if } -\frac{\pi}{2} < \sigma_2 \\ \left\{ \sigma_1, -\left(-a + e^{\frac{3t}{2} - \frac{3a}{2} + \log\left(a + \left(-\frac{1}{2} + \sigma_3\right)^{3/2}\right) + 2\pi C_2 i} \right)^{2/3} \left(\frac{1}{2} + \sigma_3\right) \right\} & \text{if } \sigma_2 \leq -\frac{\pi}{2} \text{ if } C_2 \in \mathbb{Z} \\ \emptyset & \text{if } C_2 \notin \mathbb{Z} \end{array} \right.$$

where

$$\sigma_1 = \left(-a + e^{\frac{3t}{2} - \frac{3a}{2} + \log(a+1) + 2\pi C_2 i} \right)^{2/3}$$

$$\sigma_2 = \text{angle} \left(e^{\frac{3C_1}{2} + \frac{3t}{2}} - a \right)$$

$$\sigma_3 = \frac{\sqrt{3} i}{2}$$

Find Series Solution of Differential Equation

Solve the second-order differential equation $(x^2 - 1)^2 \frac{\partial^2}{\partial x^2} y(x) + (x + 1) \frac{\partial}{\partial x} y(x) - y(x) = 0$. `dsolve` returns a solution that contains a term with unevaluated integral.

```
syms y(x)
eqn = (x^2-1)^2*diff(y,2) + (x+1)*diff(y) - y == 0;
S = dsolve(eqn)
```

```
S =
```

$$C_2(x+1) + C_1(x+1) \int \frac{1}{e^{2(x-1)} (1-x)^{1/4} (x+1)^{9/4}} dx$$

To return series solutions of the differential equation around $x = -1$, set the 'ExpansionPoint' to -1. `dsolve` returns two linearly independent solutions in terms of a Puiseux series expansion.

```
S = dsolve(eqn, 'ExpansionPoint', -1)
```

$$S = \left(\begin{array}{c} x + 1 \\ \frac{1}{(x + 1)^{1/4}} - \frac{5(x + 1)^{3/4}}{4} + \frac{5(x + 1)^{7/4}}{48} + \frac{5(x + 1)^{11/4}}{336} + \frac{115(x + 1)^{15/4}}{33792} + \frac{169(x + 1)^{19/4}}{184320} \end{array} \right)$$

Find other series solutions around the expansion point ∞ by setting 'ExpansionPoint' to Inf.

```
S = dsolve(eqn, 'ExpansionPoint', Inf)
```

$$S = \left(\begin{array}{c} x - \frac{1}{6x^2} - \frac{1}{8x^4} \\ \frac{1}{6x^2} + \frac{1}{8x^4} + \frac{1}{90x^5} + 1 \end{array} \right)$$

The default truncation order of the series expansion is 6. To obtain more terms in the Puiseux series solutions, set 'Order' to 8.

```
S = dsolve(eqn, 'ExpansionPoint', Inf, 'Order', 8)
```

$$S = \left(\begin{array}{c} x - \frac{1}{6x^2} - \frac{1}{8x^4} - \frac{1}{90x^5} - \frac{37}{336x^6} \\ \frac{1}{6x^2} + \frac{1}{8x^4} + \frac{1}{90x^5} + \frac{37}{336x^6} + \frac{37}{1680x^7} + 1 \end{array} \right)$$

Specify Initial Condition for Function with Different One-Sided Limits

Solve the differential equation $\frac{dy}{dx} = \frac{1}{x^2}e^{-\frac{1}{x}}$ without specifying the initial condition.

```
syms y(x)
eqn = diff(y) == exp(-1/x)/x^2;
ySol(x) = dsolve(eqn)
```

$$ySol(x) = C_1 + e^{-\frac{1}{x}}$$

To eliminate constants from the solution, specify the initial condition $y(0) = 1$.

```
cond = y(0) == 1;
S = dsolve(eqn, cond)
```

$$S = e^{-\frac{1}{x}} + 1$$

The function $e^{-\frac{1}{x}}$ in the solution `ySol(x)` has different one-sided limits at $x = 0$. The function has a right-side limit, $\lim_{x \rightarrow 0^+} e^{-\frac{1}{x}} = 0$, but it has undefined left-side limit, $\lim_{x \rightarrow 0^-} e^{-\frac{1}{x}} = \infty$.

When you specify the condition $y(x_0)$ for a function with different one-sided limits at x_0 , `dsolve` treats the condition as a limit from the right, $\lim_{x \rightarrow x_0^+}$.

Input Arguments

eqn — Differential equation or system of equations

symbolic equation | vector of symbolic equations

Differential equation or system of equations, specified as a symbolic equation or a vector of symbolic equations. Specify a differential equation by using the `==` operator. If `eqn` is a symbolic expression (without the right side), the solver assumes that the right side is 0, and solves the equation `eqn == 0`.

In the equation, represent differentiation by using `diff`. For example, `diff(y,x)` differentiates the symbolic function $y(x)$ with respect to x . Create the symbolic function $y(x)$ by using `syms` and solve the equation $d^2y(x)/dx^2 = x*y(x)$ using `dsolve`.

```
syms y(x)
dsolve(diff(y,x,2) == x*y)
```

Specify a system of differential equations by using a vector of equations, as in `dsolve([diff(y,t) == z, diff(z,t) == -y])`.

cond — Initial or boundary condition

symbolic equation | vector of symbolic equations

Initial or boundary condition, specified as a symbolic equation or vector of symbolic equations.

When a condition contains a derivative, represent the derivative with `diff`. Assign the `diff` call to a variable and use the variable to specify the condition. For example, see “Solve Differential Equations with Conditions” on page 4-300.

Specify multiple conditions by using a vector of equations. If the number of conditions is less than the number of dependent variables, the solutions contain the arbitrary constants C_1, C_2, \dots

Name-Value Pair Arguments

Specify optional comma-separated pairs of `Name, Value` arguments. `Name` is the argument name and `Value` is the corresponding value. `Name` must appear inside quotes. You can specify several name and value pair arguments in any order as `Name1, Value1, ..., NameN, ValueN`.

Example: `'IgnoreAnalyticConstraints', false` does not apply internal simplifications.

ExpansionPoint — Expansion point of Puiseux series solution

0 (default) | number | symbolic number | symbolic variable | symbolic function | symbolic expression

Expansion point of a Puiseux series solution, specified as a number, or a symbolic number, variable, function, or expression. Specifying this option returns the solution of a differential equation in terms

of a Puiseux series (a power series that allows negative and fractional exponents). The expansion point cannot depend on the series variable. For example, see “Find Series Solution of Differential Equation” on page 4-303.

Data Types: `single` | `double` | `sym`
 Complex Number Support: Yes

IgnoreAnalyticConstraints — Option to use internal simplifications

`true` (default) | `false`

Option to use internal simplifications, specified as `true` or `false`.

By default, the solver applies simplifications while solving the differential equation. These simplifications might not be generally valid. Therefore, by default, the solver does not guarantee the completeness of results. If 'IgnoreAnalyticConstraints' is `true`, always verify results returned by the `dsolve` function. For more details, see “Algorithms” on page 4-307.

To solve ordinary differential equations without these simplifications, set 'IgnoreAnalyticConstraints' to `false`. Results obtained with 'IgnoreAnalyticConstraints' set to `false` are correct for all values of the arguments. For certain equations, `dsolve` might not return an explicit solution if you set 'IgnoreAnalyticConstraints' to `false`.

Implicit — Option to return implicit solution

`false` (default) | `true`

Option to return an implicit solution, specified as `false` or `true`. For a differential equation with variables x and $y(x)$, an implicit solution has the form $F(y(x)) = g(x)$.

By default, the solver tries to find an explicit solution $y(x) = f(x)$ analytically when solving a differential equation. If `dsolve` cannot find an explicit solution, then you can try finding a solution in implicit form by specifying the 'Implicit' option to `true`.

MaxDegree — Maximum degree of polynomial equation for which solver uses explicit formulas

2 (default) | positive integer smaller than 5

Maximum degree of polynomial equations for which the solver uses explicit formulas, specified as a positive integer smaller than 5. `dsolve` does not use explicit formulas when solving polynomial equations of degrees larger than 'MaxDegree'.

Order — Truncation order of Puiseux series solution

0 (default) | positive integer | symbolic positive integer

Truncation order of a Puiseux series solution, specified as a positive integer or a symbolic positive integer. Specifying this option returns the solution of a differential equation in terms of a Puiseux series (a power series that allow negative and fractional exponents). The truncation order n is the exponent in the O -term: $O(\text{var}^n)$ or $O(\text{var}^{-n})$.

Output Arguments

S — Solutions of differential equation

symbolic expression | vector of symbolic expressions

Solutions of differential equation, returned as a symbolic expression or a vector of symbolic expressions. The size of S is the number of solutions.

y_1, \dots, y_N — Variables storing solutions of differential equations

vector of symbolic variables

Variables storing solutions of differential equations, returned as a vector of symbolic variables. The number of output variables must equal the number of dependent variables in a system of equations. `dsolve` sorts the dependent variables alphabetically, and then assigns the solutions for the variables to output variables or symbolic arrays.

Tips

- If `dsolve` cannot find an explicit or implicit solution, then it issues a warning and returns the empty `sym`. In this case, try to find a numeric solution using the MATLAB `ode23` or `ode45` function. Sometimes, the output is an equivalent lower-order differential equation or an integral.
- `dsolve` does not always return complete solutions even if `'IgnoreAnalyticConstraints'` is `false`.
- If `dsolve` returns a function that has different one-sided limits at x_0 and you specify the condition $y(x_0)$, then `dsolve` treats the condition as a limit from the right, $\lim_{x \rightarrow x_0^+}$.

Algorithms

If you do not set `'IgnoreAnalyticConstraints'` to `false`, then `dsolve` applies these rules while solving the equation:

- $\log(a) + \log(b) = \log(a \cdot b)$ for all values of a and b . In particular, the following equality is applied for all values of a , b , and c :

$$(a \cdot b)^c = a^c \cdot b^c.$$

- $\log(a^b) = b \cdot \log(a)$ for all values of a and b . In particular, the following equality is applied for all values of a , b , and c :

$$(a^b)^c = a^{b \cdot c}.$$

- If f and g are standard mathematical functions and $f(g(x)) = x$ for all small positive numbers, $f(g(x)) = x$ is assumed to be valid for all complex x . In particular:
 - $\log(e^x) = x$
 - $\text{asin}(\sin(x)) = x$, $\text{acos}(\cos(x)) = x$, $\text{atan}(\tan(x)) = x$
 - $\text{asinh}(\sinh(x)) = x$, $\text{acosh}(\cosh(x)) = x$, $\text{atanh}(\tanh(x)) = x$
 - $W_k(x \cdot e^x) = x$ for all branch indices k of the Lambert W function.
- The solver can multiply both sides of an equation by any expression except 0 .
- The solutions of polynomial equations must be complete.

Compatibility Considerations

`dsolve` will no longer support character vector or string inputs

Warns starting in R2019b

`dsolve` will not accept equations as strings or character vectors in a future release. Instead, use symbolic expressions or `sym` objects to define differential equations. For example, replace inputs such as `dsolve('Dy = y')` with `syms y(t); dsolve(diff(y,t) == y)`.

See Also

`functionalDerivative` | `linsolve` | `ode23` | `ode45` | `odeToVectorField` | `solve` | `syms` | `vpasolve`

Topics

“Solve Differential Equation” on page 2-185

“Solve a System of Differential Equations” on page 2-189

Introduced before R2006a

ei

One-argument exponential integral function

Syntax

`ei(x)`

Description

`ei(x)` returns the one-argument exponential integral defined as

$$ei(x) = \int_{-\infty}^x \frac{e^t}{t} dt.$$

Examples

Exponential Integral for Floating-Point and Symbolic Numbers

Compute exponential integrals for numeric inputs. Because these numbers are not symbolic objects, you get floating-point results.

```
s = [ei(-2), ei(-1/2), ei(1), ei(sqrt(2))]
```

```
s =
    -0.0489    -0.5598     1.8951     3.0485
```

Compute exponential integrals for the same numbers converted to symbolic objects. For most symbolic (exact) numbers, `ei` returns unresolved symbolic calls.

```
s = [ei(sym(-2)), ei(sym(-1/2)), ei(sym(1)), ei(sqrt(sym(2)))]
```

```
s =
[ ei(-2), ei(-1/2), ei(1), ei(2^(1/2))]
```

Use `vpa` to approximate this result with 10-digit accuracy.

```
vpa(s, 10)
```

```
ans =
[ -0.04890051071, -0.5597735948, 1.895117816, 3.048462479]
```

Branch Cut at Negative Real Axis

The negative real axis is a branch cut. The exponential integral has a jump of height $2\pi i$ when crossing this cut. Compute the exponential integrals at -1 , above -1 , and below -1 to demonstrate this.

```
[ei(-1), ei(-1 + 10^(-10)*i), ei(-1 - 10^(-10)*i)]
```

```
ans =
    -0.2194 + 0.0000i    -0.2194 + 3.1416i    -0.2194 - 3.1416i
```

Derivatives of Exponential Integral

Compute the first, second, and third derivatives of a one-argument exponential integral.

```
syms x
diff(ei(x), x)
diff(ei(x), x, 2)
diff(ei(x), x, 3)

ans =
exp(x)/x

ans =
exp(x)/x - exp(x)/x^2

ans =
exp(x)/x - (2*exp(x))/x^2 + (2*exp(x))/x^3
```

Limits of Exponential Integral

Compute the limits of a one-argument exponential integral.

```
syms x
limit(ei(2*x^2/(1+x)), x, -Inf)
limit(ei(2*x^2/(1+x)), x, 0)
limit(ei(2*x^2/(1+x)), x, Inf)

ans =
0

ans =
-Inf

ans =
Inf
```

Input Arguments

x — Input

floating-point number | symbolic number | symbolic variable | symbolic expression | symbolic function
| symbolic vector | symbolic matrix

Input specified as a floating-point number or symbolic number, variable, expression, function, vector, or matrix.

Tips

- The one-argument exponential integral is singular at $x = 0$. The toolbox uses this special value: $ei(0) = -Inf$.

Algorithms

The relation between `ei` and `expint` is

$$ei(x) = -expint(1, -x) + (\ln(x) - \ln(1/x))/2 - \ln(-x)$$

Both functions $\text{ei}(x)$ and $\text{expint}(1,x)$ have a logarithmic singularity at the origin and a branch cut along the negative real axis. The ei function is not continuous when approached from above or below this branch cut.

References

- [1] Gautschi, W., and W. F. Gahill "Exponential Integral and Related Functions." *Handbook of Mathematical Functions with Formulas, Graphs, and Mathematical Tables*. (M. Abramowitz and I. A. Stegun, eds.). New York: Dover, 1972.

See Also

`expint` | `int` | `vpa`

Introduced in R2013a

eig

Eigenvalues and eigenvectors of symbolic matrix

Syntax

```
lambda = eig(A)
[V,D] = eig(A)
[V,D,P] = eig(A)
lambda = eig(vpa(A))
[V,D] = eig(vpa(A))
```

Description

`lambda = eig(A)` returns a symbolic vector containing the eigenvalues of the square symbolic matrix `A`.

`[V,D] = eig(A)` returns matrices `V` and `D`. The columns of `V` present eigenvectors of `A`. The diagonal matrix `D` contains eigenvalues. If the resulting `V` has the same size as `A`, the matrix `A` has a full set of linearly independent eigenvectors that satisfy $A*V = V*D$.

`[V,D,P] = eig(A)` returns a vector of indices `P`. The length of `P` equals to the total number of linearly independent eigenvectors, so that $A*V = V*D(P,P)$.

`lambda = eig(vpa(A))` returns numeric eigenvalues using variable-precision arithmetic.

`[V,D] = eig(vpa(A))` also returns numeric eigenvectors.

Examples

Compute Eigenvalues

Compute eigenvalues for the magic square of order 5.

```
M = sym(magic(5));
eig(M)

ans =
                                     65
(625/2 - (5*3145^(1/2))/2)^(1/2)
((5*3145^(1/2))/2 + 625/2)^(1/2)
-(625/2 - (5*3145^(1/2))/2)^(1/2)
-((5*3145^(1/2))/2 + 625/2)^(1/2)
```

Compute Numeric Eigenvalues to High Precision

Compute numeric eigenvalues for the magic square of order 5 using variable-precision arithmetic.

```
M = magic(sym(5));
eig(vpa(M))
```

```
ans =
        65.0
21.27676547147379553062642669797423
13.12628093070921880252564308594914
-13.126280930709218802525643085949
-21.276765471473795530626426697974
```

Compute Eigenvalues and Eigenvectors

Compute the eigenvalues and eigenvectors for one of the MATLAB test matrices.

```
A = sym(gallery(5))
A =
[ -9, 11, -21, 63, -252]
[ 70, -69, 141, -421, 1684]
[ -575, 575, -1149, 3451, -13801]
[ 3891, -3891, 7782, -23345, 93365]
[ 1024, -1024, 2048, -6144, 24572]

[v, lambda] = eig(A)
v =
     0
 21/256
-71/128
 973/256
     1

lambda =
[ 0, 0, 0, 0, 0]
[ 0, 0, 0, 0, 0]
[ 0, 0, 0, 0, 0]
[ 0, 0, 0, 0, 0]
[ 0, 0, 0, 0, 0]
```

Input Arguments

A — Matrix

symbolic matrix

Matrix, specified as a symbolic matrix.

Limitations

Matrix computations involving many symbolic variables can be slow. To increase the computational speed, reduce the number of symbolic variables by substituting the given values for some variables.

See Also

charpoly | jordan | svd | vpa

Topics

“Eigenvalues” on page 2-145

Introduced before R2006a

eliminate

Eliminate variables from rational equations

Syntax

```
expr = eliminate(eqns, vars)
```

Description

`expr = eliminate(eqns, vars)` eliminates the variables `vars` from the rational equations `eqns`. The result is a vector of symbolic expressions that is equal to zero.

Examples

Eliminate Variables from Rational Equations

Create two rational equations that contain the variables `x` and `y`.

```
syms x y
eqns = [x*y/(x-2) + y == 5/(y - x), y-x == 1/(x-1)]
```

```
eqns =

$$\left( y + \frac{xy}{x-2} = -\frac{5}{x-y}, y-x = \frac{1}{x-1} \right)$$

```

Eliminate the variable `x`. The result is a symbolic expression that is equal to zero.

```
expr = eliminate(eqns, x)
```

```
expr = [6y2 - 5y - 75]
```

Eliminate Variables from Polynomial Equations

Create two polynomial equations that contain the variables `x` and `y`.

```
syms x y
eqns = [2*x+y == 5; y-x == 1]
```

```
eqns =

$$\begin{pmatrix} 2x + y = 5 \\ y - x = 1 \end{pmatrix}$$

```

Eliminate the variable `x` from the equations. The result is a symbolic expression that is equal to zero.

```
expr = eliminate(eqns, x)
```

```
expr = [3y - 7]
```

Now, create three polynomial equations that contain the variables x , y , and z . Eliminate the variable x . The result is a vector of symbolic expressions that is equal to zero.

```
syms z
eqns = [x^2 + y-z^2 == 2;
        x - z == y;
        x^2 + y^2-z == 4];
expr = eliminate(eqns,x)

expr = [5z^3 - 5z^2 - 8z + 4y - 8, 5z^4 - 11z^2 - 18z - 8]
```

To eliminate both x and y , use the `eliminate` function and specify the two variables as the vector `[x y]`.

```
expr = eliminate(eqns,[x y])

expr = [5z^4 - 11z^2 - 18z - 8]
```

Input Arguments

eqns — Rational equations

vector of symbolic equations | vector of symbolic expressions

Rational equations, specified as a vector of symbolic equations or symbolic expressions. A rational equation is an equation that contains at least one fraction in which the numerator and the denominator are polynomials.

The relation operator `==` defines symbolic equations. If a symbolic expression `eqn` in `eqns` has no right side, then a symbolic equation with a right side equal to 0 is assumed.

vars — Variables to eliminate

vector of symbolic variables

Variables to eliminate, specified as a vector of symbolic variables.

See Also

`gbasis` | `solve`

Introduced in R2018a

ellipke

Complete elliptic integrals of the first and second kinds

Syntax

```
[K,E] = ellipke(m)
```

Description

`[K,E] = ellipke(m)` returns the complete elliptic integrals of the first on page 4-319 and second kinds on page 4-319.

Examples

Compute Complete Elliptic Integrals of First and Second Kind

Compute the complete elliptic integrals of the first and second kinds for these numbers. Because these numbers are not symbolic objects, you get floating-point results.

```
[K0, E0] = ellipke(0)
[K05, E05] = ellipke(1/2)
```

```
K0 =
    1.5708
```

```
E0 =
    1.5708
```

```
K05 =
    1.8541
```

```
E05 =
    1.3506
```

Compute the complete elliptic integrals for the same numbers converted to symbolic objects. For most symbolic (exact) numbers, `ellipke` returns results using the `ellipticK` and `ellipticE` functions.

```
[K0, E0] = ellipke(sym(0))
[K05, E05] = ellipke(sym(1/2))
```

```
K0 =
pi/2
```

```
E0 =
pi/2
```

```
K05 =
ellipticK(1/2)
```

```
E05 =
ellipticE(1/2)
```

Use `vpa` to approximate `K05` and `E05` with floating-point numbers:

```
vpa([K05, E05], 10)

ans =
[ 1.854074677, 1.350643881]
```

Compute Integrals When Input is Not Between 0 and 1

If the argument does not belong to the range from 0 to 1, then convert that argument to a symbolic object before using `ellipke`:

```
[K, E] = ellipke(sym(pi/2))

K =
ellipticK(pi/2)

E =
ellipticE(pi/2)
```

Alternatively, use `ellipticK` and `ellipticE` to compute the integrals of the first and the second kinds separately:

```
K = ellipticK(sym(pi/2))
E = ellipticE(sym(pi/2))

K =
ellipticK(pi/2)

E =
ellipticE(pi/2)
```

Compute Integrals for Matrix Input

Call `ellipke` for this symbolic matrix. When the input argument is a matrix, `ellipke` computes the complete elliptic integrals of the first and second kinds for each element.

```
[K, E] = ellipke(sym([-1 0; 1/2 1]))

K =
[ ellipticK(-1), pi/2]
[ ellipticK(1/2), Inf]

E =
[ ellipticE(-1), pi/2]
[ ellipticE(1/2), 1]
```

Input Arguments

m — Input

number | vector | matrix | array | symbolic number | symbolic variable | symbolic array | symbolic function | symbolic expression

Input, specified as a number, vector, matrix, or array, or a symbolic number, variable, array, function, or expression.

Output Arguments

K — Complete elliptic integral of the first kind

symbolic expression

Complete elliptic integral of the first kind, returned as a symbolic expression.

E — Complete elliptic integral of the second kind

symbolic expression

Complete elliptic integral of the second kind, returned as a symbolic expression.

More About

Complete Elliptic Integral of the First Kind

The complete elliptic integral of the first kind is defined as follows:

$$K(m) = F\left(\frac{\pi}{2} \mid m\right) = \int_0^{\pi/2} \frac{1}{\sqrt{1 - m\sin^2\theta}} d\theta$$

Note that some definitions use the elliptical modulus k or the modular angle α instead of the parameter m . They are related as $m = k^2 = \sin^2\alpha$.

Complete Elliptic Integral of the Second Kind

The complete elliptic integral of the second kind is defined as follows:

$$E(m) = E\left(\frac{\pi}{2} \mid m\right) = \int_0^{\pi/2} \sqrt{1 - m\sin^2\theta} d\theta$$

Note that some definitions use the elliptical modulus k or the modular angle α instead of the parameter m . They are related as $m = k^2 = \sin^2\alpha$.

Tips

- Calling `ellipke` for numbers that are not symbolic objects invokes the MATLAB `ellipke` function. This function accepts only $0 \leq x \leq 1$. To compute the complete elliptic integrals of the first and second kinds for the values out of this range, use `sym` to convert the numbers to symbolic objects, and then call `ellipke` for those symbolic objects. Alternatively, use the `ellipticK` and `ellipticE` functions to compute the integrals separately.
- For most symbolic (exact) numbers, `ellipke` returns results using the `ellipticK` and `ellipticE` functions. You can approximate such results with floating-point numbers using `vpa`.
- If m is a vector or a matrix, then `[K,E] = ellipke(m)` returns the complete elliptic integrals of the first and second kinds, evaluated for each element of m .

Alternatives

You can use `ellipticK` and `ellipticE` to compute elliptic integrals of the first and second kinds separately.

References

- [1] Milne-Thomson, L. M. "Elliptic Integrals." *Handbook of Mathematical Functions with Formulas, Graphs, and Mathematical Tables*. (M. Abramowitz and I. A. Stegun, eds.). New York: Dover, 1972.

See Also

`ellipke` | `ellipticE` | `ellipticK` | `vpa`

Introduced in R2013a

ellipticCE

Complementary complete elliptic integral of the second kind

Syntax

```
ellipticCE(m)
```

Description

`ellipticCE(m)` returns the complementary complete elliptic integral of the second kind on page 4-323.

Examples

Find Complementary Complete Elliptic Integral of the Second Kind

Compute the complementary complete elliptic integrals of the second kind for these numbers. Because these numbers are not symbolic objects, you get floating-point results.

```
s = [ellipticCE(0), ellipticCE(pi/4),...
     ellipticCE(1), ellipticCE(pi/2)]
```

```
s =
    1.0000    1.4828    1.5708    1.7753
```

Compute the complementary complete elliptic integrals of the second kind for the same numbers converted to symbolic objects. For most symbolic (exact) numbers, `ellipticCE` returns unresolved symbolic calls.

```
s = [ellipticCE(sym(0)), ellipticCE(sym(pi/4)),...
     ellipticCE(sym(1)), ellipticCE(sym(pi/2))]
```

```
s =
[ 1, ellipticCE(pi/4), pi/2, ellipticCE(pi/2)]
```

Use `vpa` to approximate this result with floating-point numbers:

```
vpa(s, 10)
```

```
ans =
[ 1.0, 1.482786927, 1.570796327, 1.775344699]
```

Find Elliptic Integral for Matrix Input

Call `ellipticCE` for this symbolic matrix. When the input argument is a matrix, `ellipticCE` computes the complementary complete elliptic integral of the second kind for each element.

```
ellipticCE(sym([pi/6 pi/4; pi/3 pi/2]))
```

```
ans =
[ ellipticCE(pi/6), ellipticCE(pi/4)]
[ ellipticCE(pi/3), ellipticCE(pi/2)]
```

Differentiate Complementary Complete Elliptic Integral of the Second Kind

Differentiate these expressions involving the complementary complete elliptic integral of the second kind:

```
syms m
diff(ellipticCE(m))
diff(ellipticCE(m^2), m, 2)

ans =
ellipticCE(m)/(2*m - 2) - ellipticCK(m)/(2*m - 2)

ans =
(2*ellipticCE(m^2))/(2*m^2 - 2) -...
(2*ellipticCK(m^2))/(2*m^2 - 2) +...
2*m*((2*m*ellipticCK(m^2))/(2*m^2 - 2) -...
ellipticCE(m^2)/(m*(m^2 - 1)))/(2*m^2 - 2) +...
(2*m*(ellipticCE(m^2))/(2*m^2 - 2) -...
ellipticCK(m^2)/(2*m^2 - 2))/(2*m^2 - 2) -...
(4*m*ellipticCE(m^2))/(2*m^2 - 2)^2 +...
(4*m*ellipticCK(m^2))/(2*m^2 - 2)^2
```

Here, `ellipticCK` represents the complementary complete elliptic integral of the first kind.

Plot Complementary Complete Elliptic Integral of Second Kind

Plot the complementary complete elliptic integral of the second kind.

```
syms m
fplot(ellipticCE(m))
title('Complementary complete elliptic integral of the second kind')
ylabel('ellipticCE(m)')
grid on
```

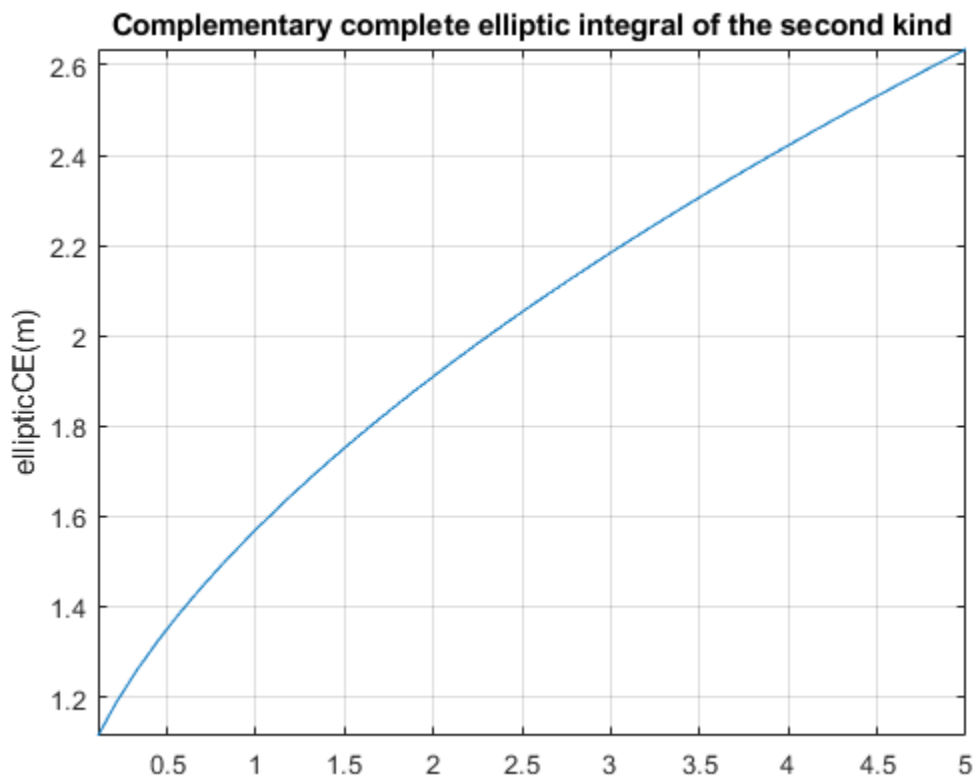
Input Arguments

m – Input

number | vector | matrix | array | symbolic number | symbolic variable | symbolic array | symbolic function | symbolic expression

Input, specified as a number, vector, matrix, or array, or a symbolic number, variable, array, function, or expression.

More About

Complementary Complete Elliptic Integral of the Second Kind

The complementary complete elliptic integral of the second kind is defined as $E'(m) = E(1-m)$, where $E(m)$ is the complete elliptic integral of the second kind:

$$E(m) = E\left(\frac{\pi}{2} \mid m\right) = \int_0^{\pi/2} \sqrt{1 - m \sin^2 \theta} d\theta$$

Note that some definitions use the elliptical modulus k or the modular angle α instead of the parameter m . They are related as $m = k^2 = \sin^2 \alpha$.

Tips

- `ellipticCE` returns floating-point results for numeric arguments that are not symbolic objects.
- For most symbolic (exact) numbers, `ellipticCE` returns unresolved symbolic calls. You can approximate such results with floating-point numbers using `vpa`.
- If `m` is a vector or a matrix, then `ellipticCE(m)` returns the complementary complete elliptic integral of the second kind, evaluated for each element of `m`.

References

- [1] Milne-Thomson, L. M. "Elliptic Integrals." *Handbook of Mathematical Functions with Formulas, Graphs, and Mathematical Tables*. (M. Abramowitz and I. A. Stegun, eds.). New York: Dover, 1972.

See Also

`ellipke` | `ellipticCK` | `ellipticCPi` | `ellipticE` | `ellipticF` | `ellipticK` | `ellipticPi` | `vpa`

Introduced in R2013a

ellipticCK

Complementary complete elliptic integral of the first kind

Syntax

```
ellipticCK(m)
```

Description

`ellipticCK(m)` returns the complementary complete elliptic integral of the first kind on page 4-327.

Examples

Find Complementary Complete Elliptic Integral of First Kind

Compute the complementary complete elliptic integrals of the first kind for these numbers. Because these numbers are not symbolic objects, you get floating-point results.

```
s = [ellipticCK(1/2), ellipticCK(pi/4), ellipticCK(1), ellipticCK(inf)]
```

```
s =
    1.8541    1.6671    1.5708    NaN
```

Compute the complete elliptic integrals of the first kind for the same numbers converted to symbolic objects. For most symbolic (exact) numbers, `ellipticCK` returns unresolved symbolic calls.

```
s = [ellipticCK(sym(1/2)), ellipticCK(sym(pi/4)),...
    ellipticCK(sym(1)), ellipticCK(sym(inf))]
```

```
s =
[ ellipticCK(1/2), ellipticCK(pi/4), pi/2, ellipticCK(Inf)]
```

Use `vpa` to approximate this result with floating-point numbers:

```
vpa(s, 10)
```

```
ans =
[ 1.854074677, 1.667061338, 1.570796327, NaN]
```

Differentiate Complementary Complete Elliptic Integral of First Kind

Differentiate these expressions involving the complementary complete elliptic integral of the first kind:

```
syms m
diff(ellipticCK(m))
diff(ellipticCK(m^2), m, 2)
```

```
ans =
ellipticCE(m)/(2*m*(m - 1)) - ellipticCK(m)/(2*m - 2)
```

```
ans =
(2*(ellipticCE(m^2))/(2*m^2 - 2) - ...
```

```

ellipticCK(m^2)/(2*m^2 - 2))/(m^2 - 1) -...
(2*ellipticCE(m^2))/(m^2 - 1)^2 -...
(2*ellipticCK(m^2))/(2*m^2 - 2) +...
(8*m^2*ellipticCK(m^2))/(2*m^2 - 2)^2 +...
(2*m*((2*m*ellipticCK(m^2))/(2*m^2 - 2) -...
ellipticCE(m^2)/(m*(m^2 - 1)))/(2*m^2 - 2) -...
ellipticCE(m^2)/(m^2*(m^2 - 1))

```

Here, `ellipticCE` represents the complementary complete elliptic integral of the second kind.

Find Elliptic Integral for Matrix Input

Call `ellipticCK` for this symbolic matrix. When the input argument is a matrix, `ellipticCK` computes the complementary complete elliptic integral of the first kind for each element.

```
ellipticCK(sym([pi/6 pi/4; pi/3 pi/2]))
```

```

ans =
[ ellipticCK(pi/6), ellipticCK(pi/4)]
[ ellipticCK(pi/3), ellipticCK(pi/2)]

```

Plot Complementary Complete Elliptic Integral of First Kind

Plot complementary complete elliptic integral of first kind.

```

syms m
fplot(ellipticCK(m),[0.1 5])
title('Complementary complete elliptic integral of the first kind')
ylabel('ellipticCK(m)')
grid on
hold off

```

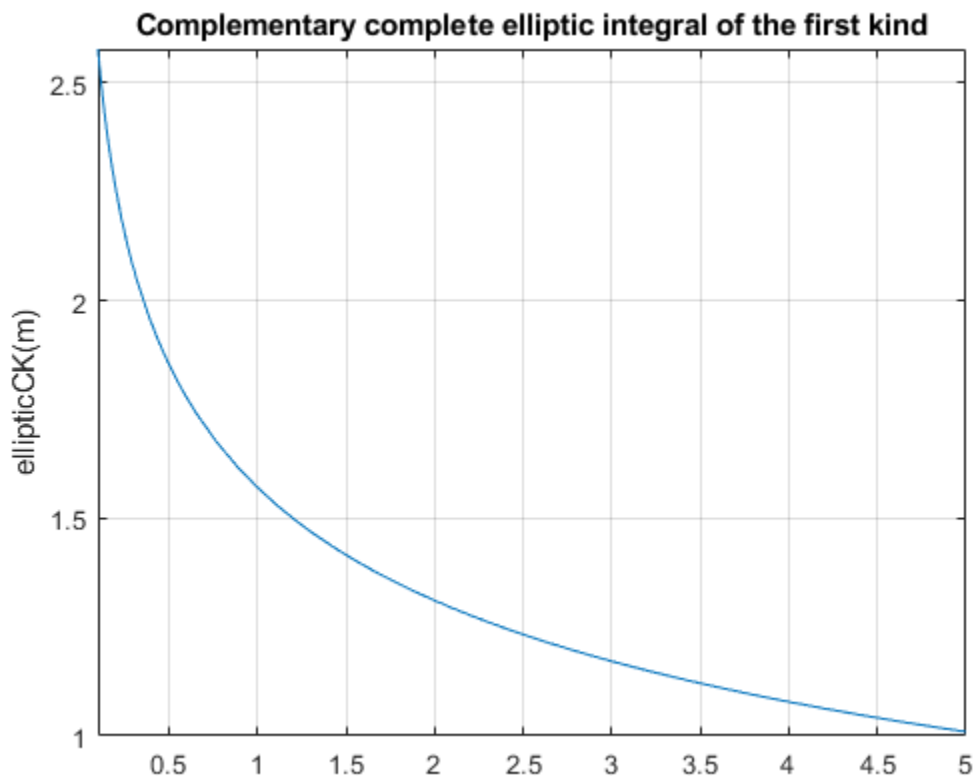

Input Arguments

m – Input

number | vector | matrix | array | symbolic number | symbolic variable | symbolic array | symbolic function | symbolic expression

Input, specified as a number, vector, matrix, or array, or a symbolic number, variable, array, function, or expression.

More About

Complementary Complete Elliptic Integral of the First Kind

The complementary complete elliptic integral of the first kind is defined as $K'(m) = K(1-m)$, where $K(m)$ is the complete elliptic integral of the first kind:

$$K(m) = F\left(\frac{\pi}{2} \middle| m\right) = \int_0^{\pi/2} \frac{1}{\sqrt{1 - m\sin^2\theta}} d\theta$$

Note that some definitions use the elliptical modulus k or the modular angle α instead of the parameter m . They are related as $m = k^2 = \sin^2\alpha$.

Tips

- `ellipticK` returns floating-point results for numeric arguments that are not symbolic objects.
- For most symbolic (exact) numbers, `ellipticCK` returns unresolved symbolic calls. You can approximate such results with floating-point numbers using the `vpa` function.
- If `m` is a vector or a matrix, then `ellipticCK(m)` returns the complementary complete elliptic integral of the first kind, evaluated for each element of `m`.

References

- [1] Milne-Thomson, L. M. "Elliptic Integrals." *Handbook of Mathematical Functions with Formulas, Graphs, and Mathematical Tables*. (M. Abramowitz and I. A. Stegun, eds.). New York: Dover, 1972.

See Also

`ellipke` | `ellipticCE` | `ellipticCPi` | `ellipticE` | `ellipticF` | `ellipticK` | `ellipticPi` | `vpa`

Introduced in R2013a

ellipticCPi

Complementary complete elliptic integral of the third kind

Syntax

```
ellipticCPi(n,m)
```

Description

`ellipticCPi(n,m)` returns the complementary complete elliptic integral of the third kind on page 4-330.

Examples

Compute Complementary Complete Elliptic Integrals of Third Kind

Compute the complementary complete elliptic integrals of the third kind for these numbers. Because these numbers are not symbolic objects, you get floating-point results.

```
s = [ellipticCPi(-1, 1/3), ellipticCPi(0, 1/2), ...
     ellipticCPi(9/10, 1), ellipticCPi(-1, 0)]
```

```
s =
    1.3703    1.8541    4.9673    Inf
```

Compute the complementary complete elliptic integrals of the third kind for the same numbers converted to symbolic objects. For most symbolic (exact) numbers, `ellipticCPi` returns unresolved symbolic calls.

```
s = [ellipticCPi(-1, sym(1/3)), ellipticCPi(sym(0), 1/2), ...
     ellipticCPi(sym(9/10), 1), ellipticCPi(-1, sym(0))]
```

```
s =
[ ellipticCPi(-1, 1/3), ellipticCK(1/2), (pi*10^(1/2))/2, Inf]
```

Here, `ellipticCK` represents the complementary complete elliptic integrals of the first kind.

Use `vpa` to approximate this result with floating-point numbers:

```
vpa(s, 10)
```

```
ans =
[ 1.370337322, 1.854074677, 4.967294133, Inf]
```

Differentiate Complementary Complete Elliptic Integrals of Third Kind

Differentiate these expressions involving the complementary complete elliptic integral of the third kind:

```
syms n m
diff(ellipticCPi(n, m), n)
diff(ellipticCPi(n, m), m)
```

```
ans =
ellipticCK(m)/(2*n*(n - 1)) - ...
ellipticCE(m)/(2*(n - 1)*(m + n - 1)) - ...
(ellipticCPi(n, m)*(n^2 + m - 1))/(2*n*(n - 1)*(m + n - 1))

ans =
ellipticCE(m)/(2*m*(m + n - 1)) - ellipticCPi(n, m)/(2*(m + n - 1))
```

Here, `ellipticCK` and `ellipticCE` represent the complementary complete elliptic integrals of the first and second kinds.

Input Arguments

n — Input

number | vector | matrix | array | symbolic number | symbolic variable | symbolic array | symbolic function | symbolic expression

Input, specified as a number, vector, matrix, or array, or a symbolic number, variable, array, function, or expression.

m — Input

number | vector | matrix | array | symbolic number | symbolic variable | symbolic array | symbolic function | symbolic expression

Input, specified as a number, vector, matrix, or array, or a symbolic number, variable, array, function, or expression.

More About

Complementary Complete Elliptic Integral of the Third Kind

The complementary complete elliptic integral of the third kind is defined as $\Pi'(m) = \Pi(n, 1-m)$, where $\Pi(n, m)$ is the complete elliptic integral of the third kind:

$$\Pi(n, m) = \Pi\left(n; \frac{\pi}{2} \mid m\right) = \int_0^{\pi/2} \frac{1}{(1 - n\sin^2\theta)\sqrt{1 - m\sin^2\theta}} d\theta$$

Note that some definitions use the elliptical modulus k or the modular angle α instead of the parameter m . They are related as $m = k^2 = \sin^2\alpha$.

Tips

- `ellipticCPi` returns floating-point results for numeric arguments that are not symbolic objects.
- For most symbolic (exact) numbers, `ellipticCPi` returns unresolved symbolic calls. You can approximate such results with floating-point numbers using `vpa`.
- At least one input argument must be a scalar or both arguments must be vectors or matrices of the same size. If one input argument is a scalar and the other one is a vector or a matrix, then `ellipticCPi` expands the scalar into a vector or matrix of the same size as the other argument with all elements equal to that scalar.

References

- [1] Milne-Thomson, L. M. "Elliptic Integrals." *Handbook of Mathematical Functions with Formulas, Graphs, and Mathematical Tables*. (M. Abramowitz and I. A. Stegun, eds.). New York: Dover, 1972.

See Also

ellipke | ellipticCE | ellipticCK | ellipticE | ellipticF | ellipticK | ellipticPi | vpa

Introduced in R2013a

ellipticE

Complete and incomplete elliptic integrals of the second kind

Syntax

```
ellipticE(m)
ellipticE(phi,m)
```

Description

`ellipticE(m)` returns the complete elliptic integral of the second kind on page 4-335.

`ellipticE(phi,m)` returns the incomplete elliptic integral of the second kind on page 4-334.

Examples

Find Complete Elliptic Integrals of Second Kind

Compute the complete elliptic integrals of the second kind for these numbers. Because these numbers are not symbolic objects, you get floating-point results.

```
s = [ellipticE(-10.5), ellipticE(-pi/4),...
    ellipticE(0), ellipticE(1)]
```

```
s =
    3.7096    1.8443    1.5708    1.0000
```

Compute the complete elliptic integral of the second kind for the same numbers converted to symbolic objects. For most symbolic (exact) numbers, `ellipticE` returns unresolved symbolic calls.

```
s = [ellipticE(sym(-10.5)), ellipticE(sym(-pi/4)),...
    ellipticE(sym(0)), ellipticE(sym(1))]
```

```
s =
[ ellipticE(-21/2), ellipticE(-pi/4), pi/2, 1]
```

Use `vpa` to approximate this result with floating-point numbers:

```
vpa(s, 10)
```

```
ans =
[ 3.70961391, 1.844349247, 1.570796327, 1.0]
```

Differentiate Elliptic Integrals of Second Kind

Differentiate these expressions involving elliptic integrals of the second kind. `ellipticK` and `ellipticF` represent the complete and incomplete elliptic integrals of the first kind, respectively.

```
syms m
diff(ellipticE(pi/3, m))
diff(ellipticE(m^2), m, 2)
```

```
ans =
ellipticE(pi/3, m)/(2*m) - ellipticF(pi/3, m)/(2*m)
```

```
ans =
2*m*((ellipticE(m^2)/(2*m^2) - ...
ellipticK(m^2)/(2*m^2))/m - ellipticE(m^2)/m^3 + ...
ellipticK(m^2)/m^3 + (ellipticK(m^2)/m + ...
ellipticE(m^2)/(m*(m^2 - 1)))/(2*m^2)) + ...
ellipticE(m^2)/m^2 - ellipticK(m^2)/m^2
```

Elliptic Integral for Matrix Input

Call `ellipticE` for this symbolic matrix. When the input argument is a matrix, `ellipticE` computes the complete elliptic integral of the second kind for each element.

```
ellipticE(sym([1/3 1; 1/2 0]))
```

```
ans =
[ ellipticE(1/3),    1]
[ ellipticE(1/2), pi/2]
```

Plot Complete and Incomplete Elliptic Integrals of Second Kind

Plot the incomplete elliptic integrals `ellipticE(phi,m)` for $\phi = \pi/4$ and $\phi = \pi/3$. Also plot the complete elliptic integral `ellipticE(m)`.

```
syms m
fplot([ellipticE(pi/4,m) ellipticE(pi/3,m) ellipticE(m)])

title('Elliptic integrals of the second kind')
legend('E(\pi/4|m)', 'E(\pi/3|m)', 'E(m)', 'Location', 'Best')
grid on
```

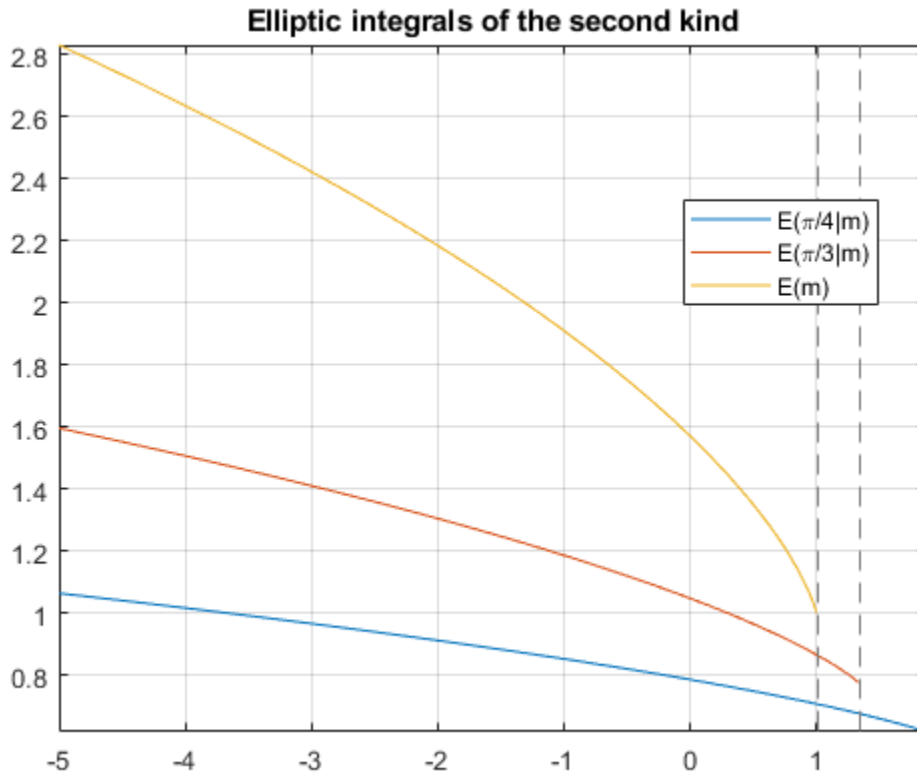

Input Arguments

m – Input

number | vector | matrix | array | symbolic number | symbolic variable | symbolic array | symbolic function | symbolic expression

Input, specified as a number, vector, matrix, or array, or a symbolic number, variable, array, function, or expression.

phi – Input

number | vector | matrix | array | symbolic number | symbolic variable | symbolic array | symbolic function | symbolic expression

Input, specified as a number, vector, matrix, or array, or a symbolic number, variable, array, function, or expression.

More About

Incomplete Elliptic Integral of the Second Kind

The incomplete elliptic integral of the second kind is defined as follows:

$$E(\varphi|m) = \int_0^{\varphi} \sqrt{1 - m \sin^2 \theta} d\theta$$

Note that some definitions use the elliptical modulus k or the modular angle α instead of the parameter m . They are related as $m = k^2 = \sin^2\alpha$.

Complete Elliptic Integral of the Second Kind

The complete elliptic integral of the second kind is defined as follows:

$$E(m) = E\left(\frac{\pi}{2} \mid m\right) = \int_0^{\pi/2} \sqrt{1 - m\sin^2\theta} d\theta$$

Note that some definitions use the elliptical modulus k or the modular angle α instead of the parameter m . They are related as $m = k^2 = \sin^2\alpha$.

Tips

- `ellipticE` returns floating-point results for numeric arguments that are not symbolic objects.
- For most symbolic (exact) numbers, `ellipticE` returns unresolved symbolic calls. You can approximate such results with floating-point numbers using `vpa`.
- If m is a vector or a matrix, then `ellipticE(m)` returns the complete elliptic integral of the second kind, evaluated for each element of m .
- At least one input argument must be a scalar or both arguments must be vectors or matrices of the same size. If one input argument is a scalar and the other one is a vector or a matrix, then `ellipticE` expands the scalar into a vector or matrix of the same size as the other argument with all elements equal to that scalar.
- `ellipticE(pi/2, m) = ellipticE(m)`.

Alternatives

You can use `ellipke` to compute elliptic integrals of the first and second kinds in one function call.

References

- [1] Milne-Thomson, L. M. "Elliptic Integrals." *Handbook of Mathematical Functions with Formulas, Graphs, and Mathematical Tables*. (M. Abramowitz and I. A. Stegun, eds.). New York: Dover, 1972.

See Also

`ellipke` | `ellipticCE` | `ellipticCK` | `ellipticCPi` | `ellipticF` | `ellipticK` | `ellipticPi` | `vpa`

Introduced in R2013a

ellipticF

Incomplete elliptic integral of the first kind

Syntax

```
ellipticF(phi,m)
```

Description

`ellipticF(phi,m)` returns the incomplete elliptic integral of the first kind on page 4-338.

Examples

Find Incomplete Elliptic Integrals of First Kind

Compute the incomplete elliptic integrals of the first kind for these numbers. Because these numbers are not symbolic objects, you get floating-point results.

```
s = [ellipticF(pi/3, -10.5), ellipticF(pi/4, -pi),...
    ellipticF(1, -1), ellipticF(pi/2, 0)]
```

```
s =
    0.6184    0.6486    0.8964    1.5708
```

Compute the incomplete elliptic integrals of the first kind for the same numbers converted to symbolic objects. For most symbolic (exact) numbers, `ellipticF` returns unresolved symbolic calls.

```
s = [ellipticF(sym(pi/3), -10.5), ellipticF(sym(pi/4), -pi),...
    ellipticF(sym(1), -1), ellipticF(pi/6, sym(0))]
```

```
s =
[ ellipticF(pi/3, -21/2), ellipticF(pi/4, -pi), ellipticF(1, -1), pi/6]
```

Use `vpa` to approximate this result with floating-point numbers:

```
vpa(s, 10)
```

```
ans =
[ 0.6184459461, 0.6485970495, 0.8963937895, 0.5235987756]
```

Differentiate Incomplete Elliptic Integrals of First Kind

Differentiate this expression involving the incomplete elliptic integral of the first kind. `ellipticE` represents the incomplete elliptic integral of the second kind.

```
syms m
diff(ellipticF(pi/4, m))
```

```
ans =
1/(4*(1 - m/2)^(1/2)*(m - 1)) - ellipticF(pi/4, m)/(2*m) - ...
ellipticE(pi/4, m)/(2*m*(m - 1))
```

Plot Incomplete and Complete Elliptic Integrals

Plot the incomplete elliptic integrals `ellipticF(phi,m)` for $\phi = \pi/4$ and $\phi = \pi/3$. Also plot the complete elliptic integral `ellipticK(m)`.

```
syms m
fplot([ellipticF(pi/4, m) ellipticF(pi/3, m) ellipticK(m)])
grid on

title('Elliptic integrals of the first kind')
legend('F(\pi/4,m)', 'F(\pi/3,m)', 'K(m)', 'Location', 'Best')
```

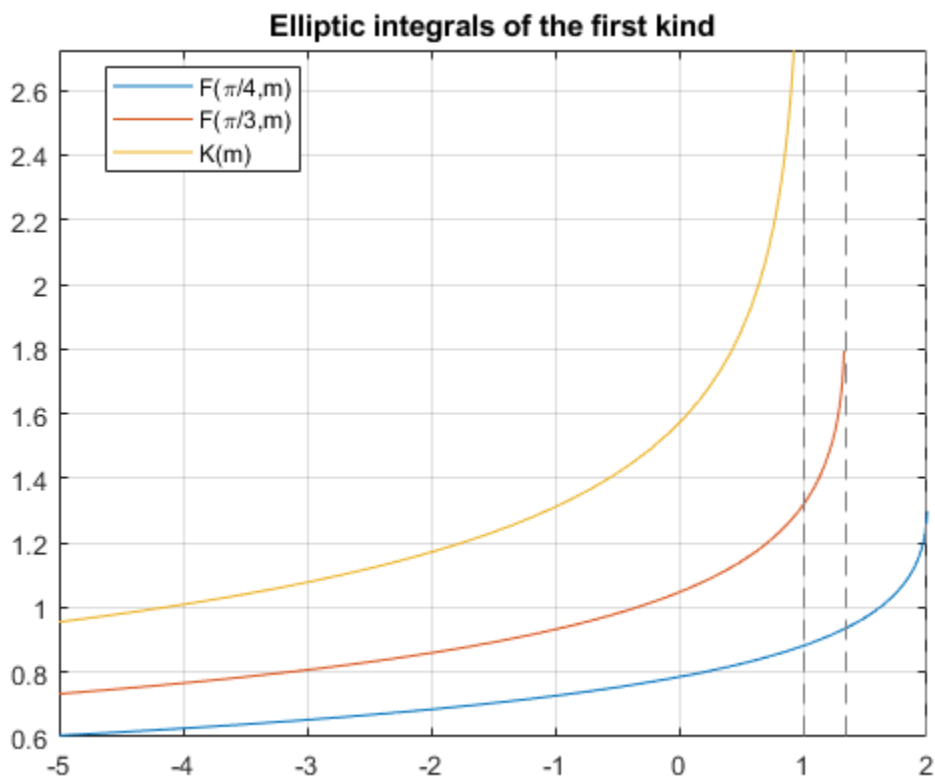

Input Arguments

m — Input

number | vector | matrix | array | symbolic number | symbolic variable | symbolic array | symbolic function | symbolic expression

Input, specified as a number, vector, matrix, or array, or a symbolic number, variable, array, function, or expression.

phi — Input

number | vector | matrix | array | symbolic number | symbolic variable | symbolic array | symbolic function | symbolic expression

Input, specified as a number, vector, matrix, or array, or a symbolic number, variable, array, function, or expression.

More About

Incomplete Elliptic Integral of the First Kind

The complete elliptic integral of the first kind is defined as follows:

$$F(\varphi|m) = \int_0^{\varphi} \frac{1}{\sqrt{1 - m\sin^2\theta}} d\theta$$

Note that some definitions use the elliptical modulus k or the modular angle α instead of the parameter m . They are related as $m = k^2 = \sin^2\alpha$.

Tips

- `ellipticF` returns floating-point results for numeric arguments that are not symbolic objects.
- For most symbolic (exact) numbers, `ellipticF` returns unresolved symbolic calls. You can approximate such results with floating-point numbers using `vpa`.
- At least one input argument must be a scalar or both arguments must be vectors or matrices of the same size. If one input argument is a scalar and the other one is a vector or a matrix, `ellipticF` expands the scalar into a vector or matrix of the same size as the other argument with all elements equal to that scalar.
- `ellipticF(pi/2, m) = ellipticK(m)`.

References

- [1] Milne-Thomson, L. M. "Elliptic Integrals." *Handbook of Mathematical Functions with Formulas, Graphs, and Mathematical Tables*. (M. Abramowitz and I. A. Stegun, eds.). New York: Dover, 1972.

See Also

`ellipke` | `ellipticCE` | `ellipticCK` | `ellipticCPi` | `ellipticE` | `ellipticK` | `ellipticPi` | `vpa`

Introduced in R2013a

ellipticK

Complete elliptic integral of the first kind

Syntax

```
ellipticK(m)
```

Description

ellipticK(m) returns the complete elliptic integral of the first kind on page 4-341.

Examples

Find Complete Elliptic Integrals of First Kind

Compute the complete elliptic integrals of the first kind for these numbers. Because these numbers are not symbolic objects, you get floating-point results.

```
s = [ellipticK(1/2), ellipticK(pi/4), ellipticK(1), ellipticK(-5.5)]
```

```
s =
    1.8541    2.2253    Inf    0.9325
```

Compute the complete elliptic integrals of the first kind for the same numbers converted to symbolic objects. For most symbolic (exact) numbers, ellipticK returns unresolved symbolic calls.

```
s = [ellipticK(sym(1/2)), ellipticK(sym(pi/4)),...
    ellipticK(sym(1)), ellipticK(sym(-5.5))]
```

```
s =
[ ellipticK(1/2), ellipticK(pi/4), Inf, ellipticK(-11/2)]
```

Use vpa to approximate this result with floating-point numbers:

```
vpa(s, 10)
```

```
ans =
[ 1.854074677, 2.225253684, Inf, 0.9324665884]
```

Differentiate Complete Elliptic Integral of First Kind

Differentiate these expressions involving the complete elliptic integral of the first kind. ellipticE represents the complete elliptic integral of the second kind.

```
syms m
diff(ellipticK(m))
diff(ellipticK(m^2), m, 2)
```

```
ans =
- ellipticK(m)/(2*m) - ellipticE(m)/(2*m*(m - 1))
```

```
ans =
(2*ellipticE(m^2))/(m^2 - 1)^2 - (2*(ellipticE(m^2))/(2*m^2) - ...
```

```

ellipticK(m^2)/(2*m^2))/(m^2 - 1) + ellipticK(m^2)/m^2 +...
(ellipticK(m^2)/m + ellipticE(m^2)/(m*(m^2 - 1)))/m +...
ellipticE(m^2)/(m^2*(m^2 - 1))

```

Elliptic Integral for Matrix Input

Call `ellipticK` for this symbolic matrix. When the input argument is a matrix, `ellipticK` computes the complete elliptic integral of the first kind for each element.

```
ellipticK(sym([-2*pi -4; 0 1]))
```

```

ans =
[ ellipticK(-2*pi), ellipticK(-4)]
[                pi/2,          Inf]

```

Plot Complete Elliptic Integral of First Kind

Plot the complete elliptic integral of the first kind.

```

syms m
fplot(ellipticK(m))
title('Complete elliptic integral of the first kind')
ylabel('ellipticK(m)')
grid on

```

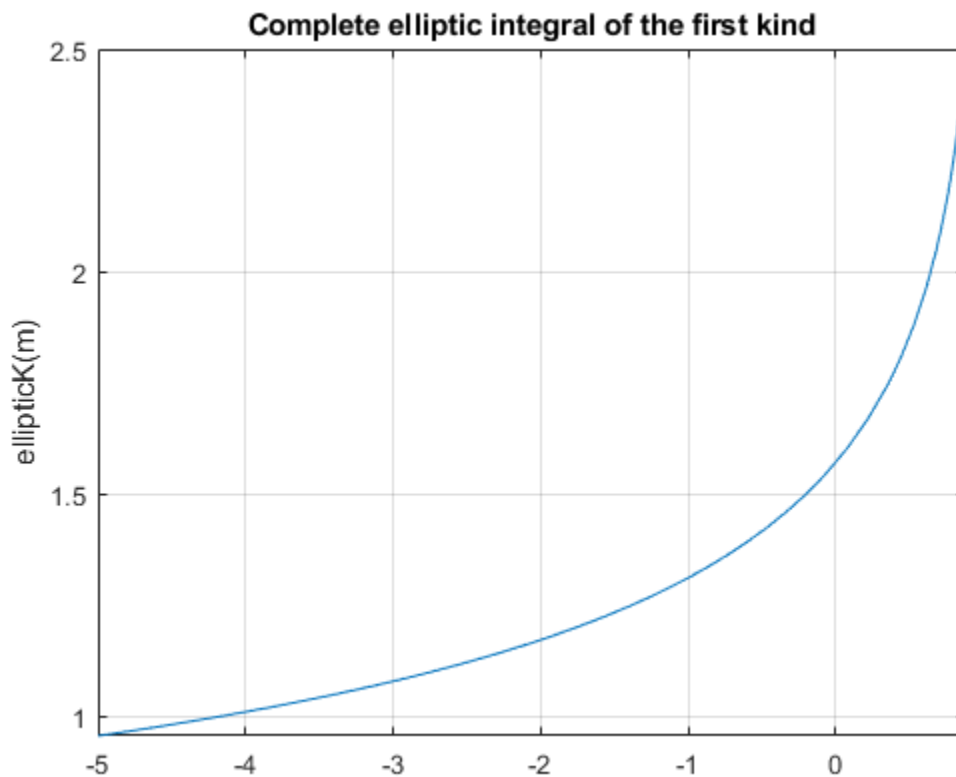

Input Arguments

m – Input

number | vector | matrix | multidimensional array | symbolic number | symbolic array | symbolic function | symbolic expression

Input, specified as a number, vector, matrix, or array, or a symbolic number, variable, array, function, or expression.

More About

Complete Elliptic Integral of the First Kind

The complete elliptic integral of the first kind is defined as follows:

$$K(m) = F\left(\frac{\pi}{2} \mid m\right) = \int_0^{\pi/2} \frac{1}{\sqrt{1 - m\sin^2\theta}} d\theta$$

Note that some definitions use the elliptical modulus k or the modular angle α instead of the parameter m . They are related as $m = k^2 = \sin^2\alpha$.

Tips

- `ellipticK` returns floating-point results for numeric arguments that are not symbolic objects.
- For most symbolic (exact) numbers, `ellipticK` returns unresolved symbolic calls. You can approximate such results with floating-point numbers using `vpa`.
- If m is a vector or a matrix, then `ellipticK(m)` returns the complete elliptic integral of the first kind, evaluated for each element of m .

Alternatives

You can use `ellipke` to compute elliptic integrals of the first and second kinds in one function call.

References

- [1] Milne-Thomson, L. M. "Elliptic Integrals." *Handbook of Mathematical Functions with Formulas, Graphs, and Mathematical Tables*. (M. Abramowitz and I. A. Stegun, eds.). New York: Dover, 1972.

See Also

`ellipke` | `ellipticCE` | `ellipticCK` | `ellipticCPi` | `ellipticE` | `ellipticF` | `ellipticPi` | `vpa`

Introduced in R2013a

ellipticNome

Elliptic nome function

Syntax

```
ellipticNome(m)
```

Description

`ellipticNome(m)` returns the “Elliptic Nome” on page 4-344 of *m*. If *m* is an array, then `ellipticNome` acts element-wise.

Examples

Calculate Elliptic Nome for Numeric Inputs

```
ellipticNome(1.3)
```

```
ans =  
    0.0881 - 0.2012i
```

Call `ellipticNome` on array inputs. `ellipticNome` acts element-wise when *m* is an array.

```
ellipticNome([2 1 -3/2])
```

```
ans =  
    0.0000 - 0.2079i    1.0000 + 0.0000i   -0.0570 + 0.0000i
```

Calculate Elliptic Nome for Symbolic Numbers

Convert numeric input to symbolic form using `sym`, and find the elliptic nome. For symbolic input where $m = 0, 1/2, \text{ or } 1$, `ellipticNome` returns exact symbolic output.

```
ellipticNome([0 1/2 1])
```

```
ans =  
    0    0.0432    1.0000
```

Show that for any other symbolic values of *m*, `ellipticNome` returns an unevaluated function call.

```
ellipticNome(sym(2))
```

```
ans =  
ellipticNome(2)
```

Find Elliptic Nome for Symbolic Variables or Expressions

For symbolic variables or expressions, `ellipticNome` returns the unevaluated function call.

```
syms x
f = ellipticNome(x)
```

```
f =
ellipticNome(x)
```

Substitute values for the variables by using `subs`, and convert values to double by using `double`.

```
f = subs(f, x, 5)
```

```
f =
ellipticNome(5)
```

```
fVal = double(f)
```

```
fVal =
-0.1008 - 0.1992i
```

Calculate `f` to higher precision using `vpa`.

```
fVal = vpa(f)
```

```
fVal =
- 0.10080189716733475056506021415746 - 0.19922973618609837873340100821425i
```

Plot Elliptic Nome

Plot the real and imaginary values of the elliptic nome using `fcontour`. Fill plot contours by setting `Fill` to `on`.

```
syms m
f = ellipticNome(m);
```

```
subplot(2,2,1)
fcontour(real(f),'Fill','on')
title('Real Values of Elliptic Nome')
xlabel('m')
```

```
subplot(2,2,2)
fcontour(imag(f),'Fill','on')
title('Imaginary Values of Elliptic Nome')
xlabel('m')
```

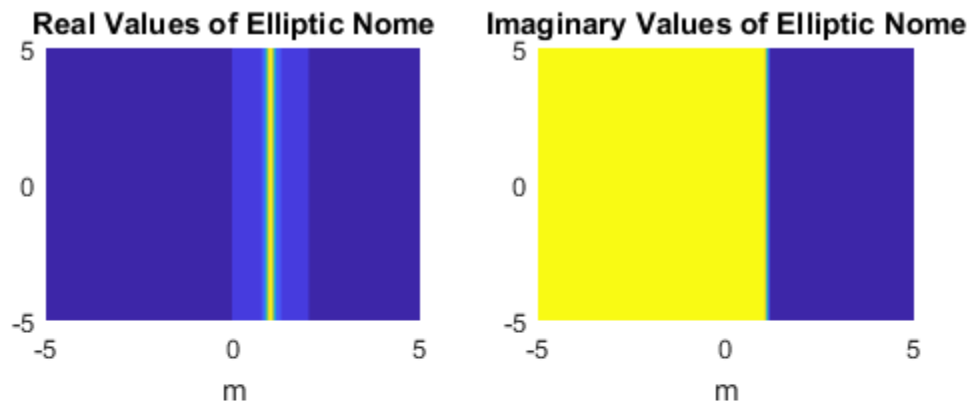

Input Arguments

m – Input

number | vector | matrix | multidimensional array | symbolic number | symbolic variable | symbolic vector | symbolic matrix | symbolic multidimensional array | symbolic function | symbolic expression

Input, specified as a number, vector, matrix, or multidimensional array, or a symbolic number, variable, vector, matrix, multidimensional array, function, or expression.

More About

Elliptic Nome

The elliptic nome is

$$q(m) = e^{-\frac{\pi K'(m)}{K(m)}}$$

where K is the complete elliptic integral of the first kind, implemented as `ellipticK`.

$|q(m)| \leq 1$ holds for all $m \in \mathbb{C}$.

See Also

`ellipticK` | `jacobiAM` | `jacobiCD` | `jacobiCN` | `jacobiCS` | `jacobiDC` | `jacobiDN` | `jacobiDS` | `jacobiNC` | `jacobiND` | `jacobiNS` | `jacobiSC` | `jacobiSD` | `jacobiSN`

Introduced in R2017b

ellipticPi

Complete and incomplete elliptic integrals of the third kind

Syntax

```
ellipticPi(n,m)
ellipticPi(n,phi,m)
```

Description

`ellipticPi(n,m)` returns the complete elliptic integral of the third kind on page 4-348.

`ellipticPi(n,phi,m)` returns the incomplete elliptic integral of the third kind on page 4-347.

Examples

Compute the Incomplete Elliptic Integrals of Third Kind

Compute the incomplete elliptic integrals of the third kind for these numbers. Because these numbers are not symbolic objects, you get floating-point results.

```
s = [ellipticPi(-2.3, pi/4, 0), ellipticPi(1/3, pi/3, 1/2),...
    ellipticPi(-1, 0, 1), ellipticPi(2, pi/6, 2)]
```

```
s =
    0.5877    1.2850         0    0.7507
```

Compute the incomplete elliptic integrals of the third kind for the same numbers converted to symbolic objects. For most symbolic (exact) numbers, `ellipticPi` returns unresolved symbolic calls.

```
s = [ellipticPi(-2.3, sym(pi/4), 0), ellipticPi(sym(1/3), pi/3, 1/2),...
    ellipticPi(-1, sym(0), 1), ellipticPi(2, pi/6, sym(2))]
```

```
s =
[ ellipticPi(-23/10, pi/4, 0), ellipticPi(1/3, pi/3, 1/2),...
0, (2^(1/2)*3^(1/2))/2 - ellipticE(pi/6, 2)]
```

Here, `ellipticE` represents the incomplete elliptic integral of the second kind.

Use `vpa` to approximate this result with floating-point numbers:

```
vpa(s, 10)
```

```
ans =
[ 0.5876852228, 1.285032276, 0, 0.7507322117]
```

Differentiate Incomplete Elliptic Integrals of Third Kind

Differentiate these expressions involving the complete elliptic integral of the third kind:

```
syms n m
diff(ellipticPi(n, m), n)
diff(ellipticPi(n, m), m)
```



```
ans =
ellipticK(m)/(2*n*(n - 1)) + ellipticE(m)/(2*(m - n)*(n - 1)) - ...
(ellipticPi(n, m)*(- n^2 + m))/(2*n*(m - n)*(n - 1))
```

```
ans =
- ellipticPi(n, m)/(2*(m - n)) - ellipticE(m)/(2*(m - n)*(m - 1))
```

Here, `ellipticK` and `ellipticE` represent the complete elliptic integrals of the first and second kinds.

Compute Integrals for Matrix Input

Call `ellipticPi` for the scalar and the matrix. When one input argument is a matrix, `ellipticPi` expands the scalar argument to a matrix of the same size with all its elements equal to the scalar.

```
ellipticPi(sym(0), sym([1/3 1; 1/2 0]))
```

```
ans =
[ ellipticK(1/3), Inf]
[ ellipticK(1/2), pi/2]
```

Here, `ellipticK` represents the complete elliptic integral of the first kind.

Input Arguments

n — Input

number | vector | matrix | array | symbolic number | symbolic variable | symbolic array | symbolic function | symbolic expression

Input, specified as a number, vector, matrix, or array, or a symbolic number, variable, array, function, or expression.

m — Input

number | vector | matrix | array | symbolic number | symbolic variable | symbolic array | symbolic function | symbolic expression

Input, specified as a number, vector, matrix, or array, or a symbolic number, variable, array, function, or expression.

phi — Input

number | vector | matrix | array | symbolic number | symbolic variable | symbolic array | symbolic function | symbolic expression

Input, specified as a number, vector, matrix, or array, or a symbolic number, variable, array, function, or expression.

More About

Incomplete Elliptic Integral of the Third Kind

The incomplete elliptic integral of the third kind is defined as follows:

$$\Pi(n; \varphi | m) = \int_0^{\varphi} \frac{1}{(1 - n \sin^2 \theta) \sqrt{1 - m \sin^2 \theta}} d\theta$$

Note that some definitions use the elliptical modulus k or the modular angle α instead of the parameter m . They are related as $m = k^2 = \sin^2\alpha$.

Complete Elliptic Integral of the Third Kind

The complete elliptic integral of the third kind is defined as follows:

$$\Pi(n, m) = \Pi\left(n; \frac{\pi}{2} \mid m\right) = \int_0^{\pi/2} \frac{1}{(1 - n\sin^2\theta)\sqrt{1 - m\sin^2\theta}} d\theta$$

Note that some definitions use the elliptical modulus k or the modular angle α instead of the parameter m . They are related as $m = k^2 = \sin^2\alpha$.

Tips

- `ellipticPi` returns floating-point results for numeric arguments that are not symbolic objects.
- For most symbolic (exact) numbers, `ellipticPi` returns unresolved symbolic calls. You can approximate such results with floating-point numbers using `vpa`.
- All non-scalar arguments must have the same size. If one or two input arguments are non-scalar, then `ellipticPi` expands the scalars into vectors or matrices of the same size as the non-scalar arguments, with all elements equal to the corresponding scalar.
- `ellipticPi(n, pi/2, m) = ellipticPi(n, m)`.

References

- [1] Milne-Thomson, L. M. "Elliptic Integrals." *Handbook of Mathematical Functions with Formulas, Graphs, and Mathematical Tables*. (M. Abramowitz and I. A. Stegun, eds.). New York: Dover, 1972.

See Also

`ellipke` | `ellipticCE` | `ellipticCK` | `ellipticCPi` | `ellipticE` | `ellipticF` | `ellipticK` | `vpa`

Introduced in R2013a

eq

Define symbolic equation

Syntax

```
A == B  
eq(A,B)
```

Description

`A == B` defines a symbolic equation. Use the equation as input to functions such as `solve`, `assume`, `fcontour`, and `subs`.

`eq(A,B)` is equivalent to `A == B`.

Examples

Define and Solve Equation

Solve this trigonometric equation. Define the equation by using the `==` operator.

```
syms x  
eqn = sin(x) == cos(x);  
solve(eqn,x)
```

```
ans =  
pi/4
```

Plot Symbolic Equation

Plot the equation $\sin(x^2) = \sin(y^2)$ by using `fimplicit`. Define the equation by using the `==` operator.

```
syms x y  
eqn = sin(x^2) == sin(y^2);  
fimplicit(eqn)
```

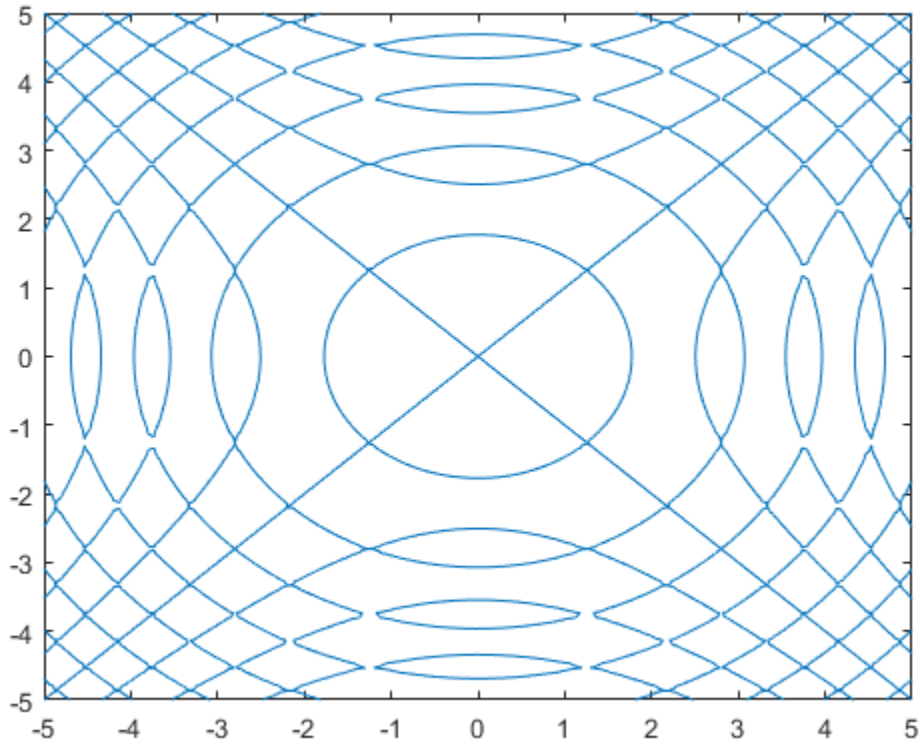

Test Equality of Symbolic Expressions

Test the equality of two symbolic expressions by using `isAlways`.

```
syms x
eqn = x+1 == x+1;
isAlways(eqn)
```

```
ans =
    logical
     1
```

```
eqn = sin(x)/cos(x) == tan(x);
isAlways(eqn)
```

```
ans =
    logical
     1
```

Test Equality of Symbolic Matrices

Check the equality of two symbolic matrices by using `isAlways`.

```
A = sym(hilb(3));
B = sym([1 1/2 5; 1/2 2 1/4; 1/3 1/8 1/5]);
isAlways(A == B)
```

```
ans =
  3×3 logical array
   1     1     0
   1     0     1
   1     0     1
```

Compare a matrix and a scalar. The `==` operator expands the scalar into a matrix of the same dimensions as the input matrix.

```
A = sym(hilb(3));
B = sym(1/2);
isAlways(A == B)
```

```
ans =
  3×3 logical array
   0     1     0
   1     0     0
   0     0     0
```

Input Arguments

A — Input

number | vector | matrix | array | symbolic number | symbolic variable | symbolic array | symbolic function | symbolic expression

Input, specified as a number, vector, matrix, or array, or a symbolic number, variable, array, function, or expression.

B — Input

number | vector | matrix | array | symbolic number | symbolic variable | symbolic array | symbolic function | symbolic expression

Input, specified as a number, vector, matrix, or array, or a symbolic number, variable, array, function, or expression.

Tips

- Calling `==` or `eq` for nonsymbolic `A` and `B` invokes the MATLAB `eq` function. This function returns a logical array with elements set to logical 1 (`true`) where `A` and `B` are equal; otherwise, it returns logical 0 (`false`).
- If both `A` and `B` are arrays, then they must have the same dimensions. `A == B` returns an array of equations `A(i,j,...) == B(i,j,...)`.

See Also

`ge` | `gt` | `isAlways` | `le` | `lt` | `ne` | `solve`

Topics

“Solve Equations” on page 1-13

“Set Assumptions” on page 1-24

Introduced in R2012a

equationsToMatrix

Convert linear equations to matrix form

Syntax

```
[A,b] = equationsToMatrix(eqns)
[A,b] = equationsToMatrix(eqns,vars)
A = equationsToMatrix( ___ )
```

Description

`[A,b] = equationsToMatrix(eqns)` converts equations `eqns` to matrix form. `eqns` must be a linear system of equations in all variables that `symvar` finds in `eqns`.

`[A,b] = equationsToMatrix(eqns,vars)` converts `eqns` to matrix form, where `eqns` must be linear in `vars`.

`A = equationsToMatrix(___)` returns only the coefficient matrix of the system of equations.

Examples

Convert Linear Equations to Matrix Form

Convert a system of linear equations to matrix form. `equationsToMatrix` automatically detects the variables in the equations by using `symvar`. The returned coefficient matrix follows the variable order determined by `symvar`.

```
syms x y z
eqns = [x+y-2*z == 0,
        x+y+z == 1,
        2*y-z == -5];
[A,b] = equationsToMatrix(eqns)
vars = symvar(eqns)
```

```
A =
[ 1, 1, -2]
[ 1, 1,  1]
[ 0, 2, -1]
```

```
b =
 0
 1
-5
```

```
vars =
[ x, y, z]
```

You can change the arrangement of the coefficient matrix by specifying other variable order.

```
vars = [x, z, y];
[A,b] = equationsToMatrix(eqns,vars)
```

```
A =
[ 1, -2, 1]
[ 1,  1, 1]
[ 0, -1, 2]
```

```
b =
  0
  1
 -5
```

Specify Variables in Equations

Convert a linear system of equations to the matrix form by specifying independent variables. This is useful when the equation are only linear in some variables.

For this system, specify the variables as `[s t]` because the system is not linear in `r`.

```
syms r s t
eqns = [s-2*t+r^2 == -1
        3*s-t == 10];
vars = [s t];
[A,b] = equationsToMatrix(eqns,vars)
```

```
A =
[ 1, -2]
[ 3, -1]
```

```
b =
- r^2 - 1
      10
```

Return Only Coefficient Matrix of Equations

Return only the coefficient matrix of the equations by specifying a single output argument.

```
syms x y z
eqns = [x+y-2*z == 0,
        x+y+z == 1,
        2*y-z == -5];
vars = [x y z];
A = equationsToMatrix(eqns,vars)
```

```
A =
[ 1, 1, -2]
[ 1, 1,  1]
[ 0, 2, -1]
```

Input Arguments

eqns — Linear equations

vector of symbolic equations or expressions

Linear equations, specified as a vector of symbolic equations or expressions. Symbolic equations are defined by using the `==` operator, such as `x + y == 1`. For symbolic expressions, `equationsToMatrix` assumes that the right side is 0.

Equations must be linear in terms of `vars`.

vars – Independent variables

vector of symbolic variables (default)

Independent variables in `eqns`, specified as a vector of symbolic variables.

Output Arguments

A – Coefficient matrix

symbolic matrix

Coefficient matrix of the system of linear equations, specified as a symbolic matrix.

b – Right sides of equations

symbolic matrix

Vector containing the right sides of equations, specified as a symbolic matrix.

More About

Matrix Representation of System of Linear Equations

A system of linear equations

$$a_{11}x_1 + a_{12}x_2 + \dots + a_{1n}x_n = b_1$$

$$a_{21}x_1 + a_{22}x_2 + \dots + a_{2n}x_n = b_2$$

...

$$a_{m1}x_1 + a_{m2}x_2 + \dots + a_{mn}x_n = b_m$$

can be represented as the matrix equation $A \cdot \vec{x} = \vec{b}$. Here, A is the coefficient matrix.

$$A = \begin{pmatrix} a_{11} & \dots & a_{1n} \\ \vdots & \ddots & \vdots \\ a_{m1} & \dots & a_{mn} \end{pmatrix}$$

\vec{b} is the vector containing the right sides of equations.

$$\vec{b} = \begin{pmatrix} b_1 \\ \vdots \\ b_m \end{pmatrix}$$

See Also

`linsolve` | `odeToVectorField` | `solve` | `symvar`

Topics

“Solve System of Linear Equations” on page 2-173

Introduced in R2012b

erf

Error function

Syntax

`erf(X)`

Description

`erf(X)` represents the error function on page 4-360 of X. If X is a vector or a matrix, `erf(X)` computes the error function of each element of X.

Examples

Error Function for Floating-Point and Symbolic Numbers

Depending on its arguments, `erf` can return floating-point or exact symbolic results.

Compute the error function for these numbers. Because these numbers are not symbolic objects, you get the floating-point results:

```
A = [erf(1/2), erf(1.41), erf(sqrt(2))]
```

```
A =
    0.5205    0.9539    0.9545
```

Compute the error function for the same numbers converted to symbolic objects. For most symbolic (exact) numbers, `erf` returns unresolved symbolic calls:

```
symA = [erf(sym(1/2)), erf(sym(1.41)), erf(sqrt(sym(2)))]
```

```
symA =
[ erf(1/2), erf(141/100), erf(2^(1/2))]
```

Use `vpa` to approximate symbolic results with the required number of digits:

```
d = digits(10);
vpa(symA)
digits(d)
```

```
ans =
[ 0.5204998778, 0.9538524394, 0.9544997361]
```

Error Function for Variables and Expressions

For most symbolic variables and expressions, `erf` returns unresolved symbolic calls.

Compute the error function for `x` and `sin(x) + x*exp(x)`:

```
syms x
f = sin(x) + x*exp(x);
erf(x)
erf(f)
```

```
ans =
erf(x)
```

```
ans =
erf(sin(x) + x*exp(x))
```

Error Function for Vectors and Matrices

If the input argument is a vector or a matrix, `erf` returns the error function for each element of that vector or matrix.

Compute the error function for elements of matrix `M` and vector `V`:

```
M = sym([0 inf; 1/3 -inf]);
V = sym([1; -i*inf]);
erf(M)
erf(V)
```

```
ans =
[ 0, 1]
[ erf(1/3), -1]
```

```
ans =
 erf(1)
 -Inf*1i
```

Special Values of Error Function

`erf` returns special values for particular parameters.

Compute the error function for $x = 0$, $x = \infty$, and $x = -\infty$. Use `sym` to convert 0 and infinities to symbolic objects. The error function has special values for these parameters:

```
[erf(sym(0)), erf(sym(Inf)), erf(sym(-Inf))]
```

```
ans =
[ 0, 1, -1]
```

Compute the error function for complex infinities. Use `sym` to convert complex infinities to symbolic objects:

```
[erf(sym(i*Inf)), erf(sym(-i*Inf))]
```

```
ans =
[ Inf*1i, -Inf*1i]
```

Handling Expressions That Contain Error Function

Many functions, such as `diff` and `int`, can handle expressions containing `erf`.

Compute the first and second derivatives of the error function:

```
syms x
diff(erf(x), x)
diff(erf(x), x, 2)
```

```
ans =
(2*exp(-x^2))/pi^(1/2)
```

```
ans =
-(4*x*exp(-x^2))/pi^(1/2)
```

Compute the integrals of these expressions:

```
int(erf(x), x)
int(erf(log(x)), x)
```

```
ans =
exp(-x^2)/pi^(1/2) + x*erf(x)
```

```
ans =
x*erf(log(x)) - int((2*exp(-log(x)^2))/pi^(1/2), x)
```

Plot Error Function

Plot the error function on the interval from -5 to 5.

```
syms x
fplot(erf(x), [-5 5])
grid on
```

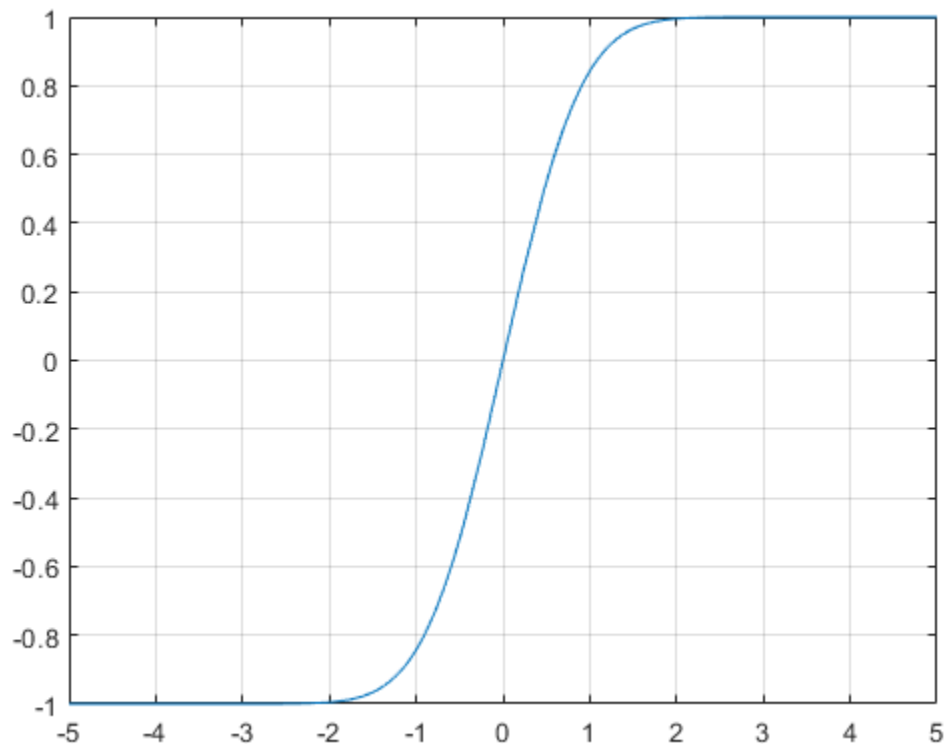

Input Arguments

X — Input

symbolic number | symbolic variable | symbolic expression | symbolic function | symbolic vector | symbolic matrix

Input, specified as a symbolic number, variable, expression, or function, or as a vector or matrix of symbolic numbers, variables, expressions, or functions.

More About

Error Function

The following integral defines the error function:

$$\operatorname{erf}(x) = \frac{2}{\sqrt{\pi}} \int_0^x e^{-t^2} dt$$

Tips

- Calling `erf` for a number that is not a symbolic object invokes the MATLAB `erf` function. This function accepts real arguments only. If you want to compute the error function for a complex number, use `sym` to convert that number to a symbolic object, and then call `erf` for that symbolic object.
- For most symbolic (exact) numbers, `erf` returns unresolved symbolic calls. You can approximate such results with floating-point numbers using `vpa`.

Algorithms

The toolbox can simplify expressions that contain error functions and their inverses. For real values x , the toolbox applies these simplification rules:

- $\operatorname{erfinv}(\operatorname{erf}(x)) = \operatorname{erfinv}(1 - \operatorname{erfc}(x)) = \operatorname{erfcinv}(1 - \operatorname{erf}(x)) = \operatorname{erfcinv}(\operatorname{erfc}(x)) = x$
- $\operatorname{erfinv}(-\operatorname{erf}(x)) = \operatorname{erfinv}(\operatorname{erfc}(x) - 1) = \operatorname{erfcinv}(1 + \operatorname{erf}(x)) = \operatorname{erfcinv}(2 - \operatorname{erfc}(x)) = -x$

For any value x , the system applies these simplification rules:

- $\operatorname{erfcinv}(x) = \operatorname{erfinv}(1 - x)$
- $\operatorname{erfinv}(-x) = -\operatorname{erfinv}(x)$
- $\operatorname{erfcinv}(2 - x) = -\operatorname{erfcinv}(x)$
- $\operatorname{erf}(\operatorname{erfinv}(x)) = \operatorname{erfc}(\operatorname{erfcinv}(x)) = x$
- $\operatorname{erf}(\operatorname{erfcinv}(x)) = \operatorname{erfc}(\operatorname{erfinv}(x)) = 1 - x$

References

- [1] Gautschi, W. "Error Function and Fresnel Integrals." *Handbook of Mathematical Functions with Formulas, Graphs, and Mathematical Tables*. (M. Abramowitz and I. A. Stegun, eds.). New York: Dover, 1972.

See Also

`erfc` | `erfcinv` | `erfi` | `erfinv`

Introduced before R2006a

erfc

Complementary error function

Syntax

```
erfc(X)
erfc(K,X)
```

Description

$\text{erfc}(X)$ represents the complementary error function on page 4-365 of *X*, that is, $\text{erfc}(X) = 1 - \text{erf}(X)$.

$\text{erfc}(K, X)$ represents the iterated integral of the complementary error function on page 4-366 of *X*, that is, $\text{erfc}(K, X) = \text{int}(\text{erfc}(K - 1, y), y, X, \text{inf})$.

Examples

Complementary Error Function for Floating-Point and Symbolic Numbers

Depending on its arguments, `erfc` can return floating-point or exact symbolic results.

Compute the complementary error function for these numbers. Because these numbers are not symbolic objects, you get the floating-point results:

```
A = [erfc(1/2), erfc(1.41), erfc(sqrt(2))]
```

```
A =
    0.4795    0.0461    0.0455
```

Compute the complementary error function for the same numbers converted to symbolic objects. For most symbolic (exact) numbers, `erfc` returns unresolved symbolic calls:

```
symA = [erfc(sym(1/2)), erfc(sym(1.41)), erfc(sqrt(sym(2)))]
```

```
symA =
[ erfc(1/2), erfc(141/100), erfc(2^(1/2))]
```

Use `vpa` to approximate symbolic results with the required number of digits:

```
d = digits(10);
vpa(symA)
digits(d)
```

```
ans =
[ 0.4795001222, 0.04614756064, 0.0455002639]
```

Error Function for Variables and Expressions

For most symbolic variables and expressions, `erfc` returns unresolved symbolic calls.

Compute the complementary error function for x and $\sin(x) + x \cdot \exp(x)$:

```

syms x
f = sin(x) + x*exp(x);
erfc(x)
erfc(f)

ans =
erfc(x)

ans =
erfc(sin(x) + x*exp(x))

```

Complementary Error Function for Vectors and Matrices

If the input argument is a vector or a matrix, `erfc` returns the complementary error function for each element of that vector or matrix.

Compute the complementary error function for elements of matrix `M` and vector `V`:

```

M = sym([0 inf; 1/3 -inf]);
V = sym([1; -i*inf]);
erfc(M)
erfc(V)

```

```

ans =
[          1, 0]
[ erfc(1/3), 2]

```

```

ans =
    erfc(1)
1 + Inf*1i

```

Compute the iterated integral of the complementary error function for the elements of `V` and `M`, and the integer `-1`:

```

erfc(-1, M)
erfc(-1, V)

```

```

ans =
[          2/pi^(1/2), 0]
[ (2*exp(-1/9))/pi^(1/2), 0]

```

```

ans =
(2*exp(-1))/pi^(1/2)
                Inf

```

Special Values of Complementary Error Function

`erfc` returns special values for particular parameters.

Compute the complementary error function for $x = 0$, $x = \infty$, and $x = -\infty$. The complementary error function has special values for these parameters:

```

[erfc(0), erfc(Inf), erfc(-Inf)]

```

```

ans =
    1     0     2

```

Compute the complementary error function for complex infinities. Use `sym` to convert complex infinities to symbolic objects:

```
[erfc(sym(i*Inf)), erfc(sym(-i*Inf))]
```

```
ans =  
[ 1 - Inf*1i, 1 + Inf*1i]
```

Handling Expressions That Contain Complementary Error Function

Many functions, such as `diff` and `int`, can handle expressions containing `erfc`.

Compute the first and second derivatives of the complementary error function:

```
syms x  
diff(erfc(x), x)  
diff(erfc(x), x, 2)
```

```
ans =  
-(2*exp(-x^2))/pi^(1/2)
```

```
ans =  
(4*x*exp(-x^2))/pi^(1/2)
```

Compute the integrals of these expressions:

```
syms x  
int(erfc(-1, x), x)
```

```
ans =  
erf(x)
```

```
int(erfc(x), x)
```

```
ans =  
x*erfc(x) - exp(-x^2)/pi^(1/2)
```

```
int(erfc(2, x), x)
```

```
ans =  
(x^3*erfc(x))/6 - exp(-x^2)/(6*pi^(1/2)) + ...  
(x*erfc(x))/4 - (x^2*exp(-x^2))/(6*pi^(1/2))
```

Plot Complementary Error Function

Plot the complementary error function on the interval from -5 to 5.

```
syms x  
fplot(erfc(x), [-5 5])  
grid on
```

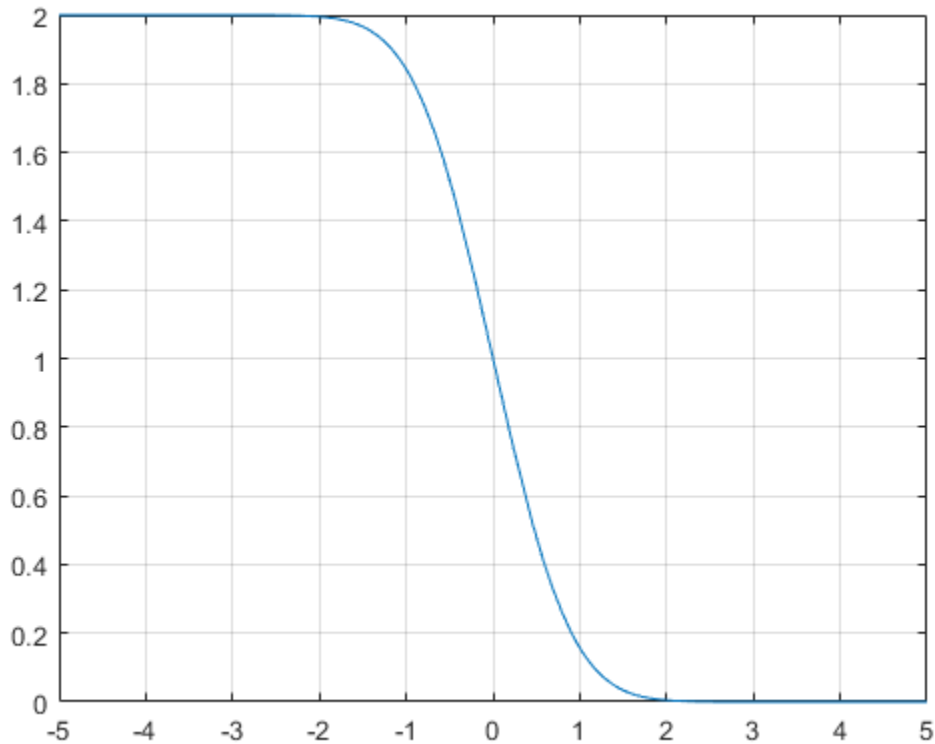

Input Arguments

X – Input

symbolic number | symbolic variable | symbolic expression | symbolic function | symbolic vector | symbolic matrix

Input, specified as a symbolic number, variable, expression, or function, or as a vector or matrix of symbolic numbers, variables, expressions, or functions.

K – Input representing an integer larger than -2

number | symbolic number | symbolic variable | symbolic expression | symbolic function | symbolic vector | symbolic matrix

Input representing an integer larger than -2, specified as a number, symbolic number, variable, expression, or function. This arguments can also be a vector or matrix of numbers, symbolic numbers, variables, expressions, or functions.

More About

Complementary Error Function

The following integral defines the complementary error function:

$$\operatorname{erfc}(x) = \frac{2}{\sqrt{\pi}} \int_x^{\infty} e^{-t^2} dt = 1 - \operatorname{erf}(x)$$

Here $\operatorname{erf}(x)$ is the error function.

Iterated Integral of Complementary Error Function

The following integral is the iterated integral of the complementary error function:

$$\operatorname{erfc}(k, x) = \int_x^{\infty} \operatorname{erfc}(k-1, y) dy$$

Here, $\operatorname{erfc}(0, x) = \operatorname{erfc}(x)$.

Tips

- Calling `erfc` for a number that is not a symbolic object invokes the MATLAB `erfc` function. This function accepts real arguments only. If you want to compute the complementary error function for a complex number, use `sym` to convert that number to a symbolic object, and then call `erfc` for that symbolic object.
- For most symbolic (exact) numbers, `erfc` returns unresolved symbolic calls. You can approximate such results with floating-point numbers using `vpa`.
- At least one input argument must be a scalar or both arguments must be vectors or matrices of the same size. If one input argument is a scalar and the other one is a vector or a matrix, then `erfc` expands the scalar into a vector or matrix of the same size as the other argument with all elements equal to that scalar.

Algorithms

The toolbox can simplify expressions that contain error functions and their inverses. For real values x , the toolbox applies these simplification rules:

- $\operatorname{erfinv}(\operatorname{erf}(x)) = \operatorname{erfinv}(1 - \operatorname{erfc}(x)) = \operatorname{erfcinv}(1 - \operatorname{erf}(x)) = \operatorname{erfcinv}(\operatorname{erfc}(x)) = x$
- $\operatorname{erfinv}(-\operatorname{erf}(x)) = \operatorname{erfinv}(\operatorname{erfc}(x) - 1) = \operatorname{erfcinv}(1 + \operatorname{erf}(x)) = \operatorname{erfcinv}(2 - \operatorname{erfc}(x)) = -x$

For any value x , the system applies these simplification rules:

- $\operatorname{erfcinv}(x) = \operatorname{erfinv}(1 - x)$
- $\operatorname{erfinv}(-x) = -\operatorname{erfinv}(x)$
- $\operatorname{erfcinv}(2 - x) = -\operatorname{erfcinv}(x)$
- $\operatorname{erf}(\operatorname{erfinv}(x)) = \operatorname{erfc}(\operatorname{erfcinv}(x)) = x$
- $\operatorname{erf}(\operatorname{erfcinv}(x)) = \operatorname{erfc}(\operatorname{erfinv}(x)) = 1 - x$

References

- [1] Gautschi, W. "Error Function and Fresnel Integrals." *Handbook of Mathematical Functions with Formulas, Graphs, and Mathematical Tables*. (M. Abramowitz and I. A. Stegun, eds.). New York: Dover, 1972.

See Also

erf | erfcinv | erfi | erfinv

Introduced in R2011b

erfcinv

Inverse complementary error function

Syntax

```
erfcinv(X)
```

Description

`erfcinv(X)` computes the inverse complementary error function on page 4-371 of X . If X is a vector or a matrix, `erfcinv(X)` computes the inverse complementary error function of each element of X .

Examples

Inverse Complementary Error Function for Floating-Point and Symbolic Numbers

Depending on its arguments, `erfcinv` can return floating-point or exact symbolic results.

Compute the inverse complementary error function for these numbers. Because these numbers are not symbolic objects, you get floating-point results:

```
A = [erfcinv(1/2), erfcinv(1.33), erfcinv(3/2)]
```

```
A =
    0.4769    -0.3013    -0.4769
```

Compute the inverse complementary error function for the same numbers converted to symbolic objects. For most symbolic (exact) numbers, `erfcinv` returns unresolved symbolic calls:

```
symA = [erfcinv(sym(1/2)), erfcinv(sym(1.33)), erfcinv(sym(3/2))]
```

```
symA =
[ -erfcinv(3/2), erfcinv(133/100), erfcinv(3/2)]
```

Use `vpa` to approximate symbolic results with the required number of digits:

```
d = digits(10);
vpa(symA)
digits(d)
```

```
ans =
[ 0.4769362762, -0.3013321461, -0.4769362762]
```

Inverse Complementary Error Function for Variables and Expressions

For most symbolic variables and expressions, `erfcinv` returns unresolved symbolic calls.

Compute the inverse complementary error function for x and $\sin(x) + x \cdot \exp(x)$. For most symbolic variables and expressions, `erfcinv` returns unresolved symbolic calls:

```
syms x
f = sin(x) + x*exp(x);
```

```

erfcinv(x)
erfcinv(f)

ans =
erfcinv(x)

ans =
erfcinv(sin(x) + x*exp(x))

```

Inverse Complementary Error Function for Vectors and Matrices

If the input argument is a vector or a matrix, `erfcinv` returns the inverse complementary error function for each element of that vector or matrix.

Compute the inverse complementary error function for elements of matrix `M` and vector `V`:

```

M = sym([0 1 + i; 1/3 1]);
V = sym([2; inf]);
erfcinv(M)
erfcinv(V)

ans =
      Inf, NaN
[-erfcinv(5/3), 0]

ans =
-Inf
NaN

```

Special Values of Inverse Complementary Error Function

`erfcinv` returns special values for particular parameters.

Compute the inverse complementary error function for $x = 0$, $x = 1$, and $x = 2$. The inverse complementary error function has special values for these parameters:

```

[erfcinv(0), erfcinv(1), erfcinv(2)]

ans =
      Inf      0 -Inf

```

Handling Expressions That Contain Inverse Complementary Error Function

Many functions, such as `diff` and `int`, can handle expressions containing `erfcinv`.

Compute the first and second derivatives of the inverse complementary error function:

```

syms x
diff(erfcinv(x), x)
diff(erfcinv(x), x, 2)

ans =
-(pi^(1/2)*exp(erfcinv(x)^2))/2

ans =
(pi*exp(2*erfcinv(x)^2)*erfcinv(x))/2

```

Compute the integral of the inverse complementary error function:

```
int(erfcinv(x), x)
ans =
exp(-erfcinv(x)^2)/pi^(1/2)
```

Plot Inverse Complementary Error Function

Plot the inverse complementary error function on the interval from 0 to 2.

```
syms x
fplot(erfcinv(x), [0 2])
grid on
```

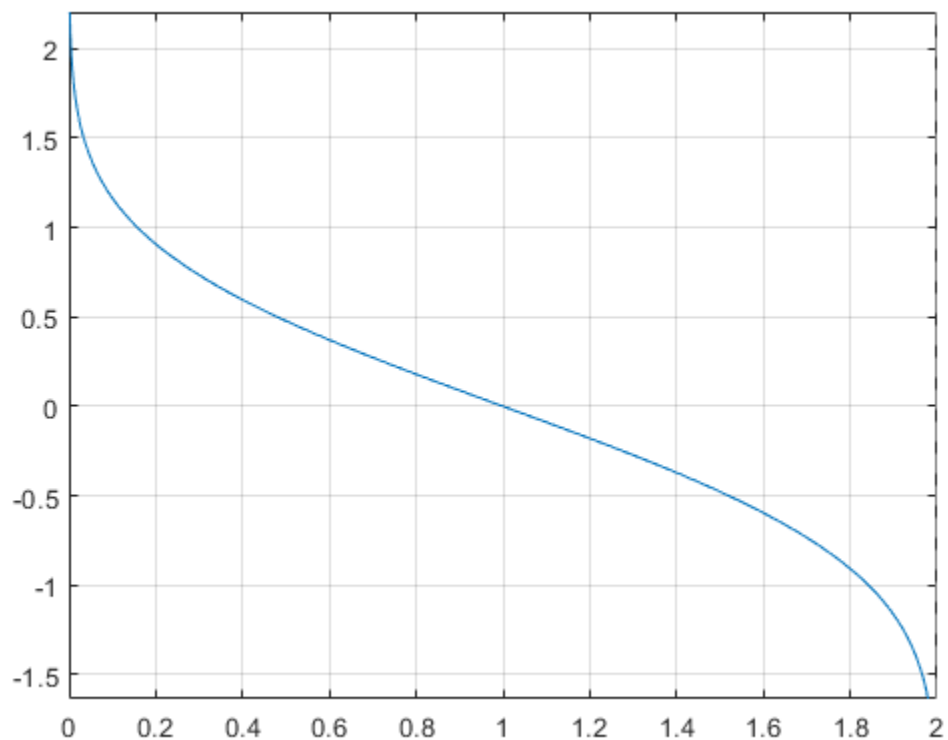

Input Arguments

X — Input

symbolic number | symbolic variable | symbolic expression | symbolic function | symbolic vector | symbolic matrix

Input, specified as a symbolic number, variable, expression, or function, or as a vector or matrix of symbolic numbers, variables, expressions, or functions.

More About

Inverse Complementary Error Function

The inverse complementary error function is defined as $\text{erfc}^{-1}(x)$, such that $\text{erfc}(\text{erfc}^{-1}(x)) = x$. Here

$$\text{erfc}(x) = \frac{2}{\sqrt{\pi}} \int_x^{\infty} e^{-t^2} dt = 1 - \text{erf}(x)$$

is the complementary error function.

Tips

- Calling `erfcinv` for a number that is not a symbolic object invokes the MATLAB `erfcinv` function. This function accepts real arguments only. If you want to compute the inverse complementary error function for a complex number, use `sym` to convert that number to a symbolic object, and then call `erfcinv` for that symbolic object.
- If $x < 0$ or $x > 2$, or if x is complex, then `erfcinv(x)` returns NaN.

Algorithms

The toolbox can simplify expressions that contain error functions and their inverses. For real values x , the toolbox applies these simplification rules:

- $\text{erfinv}(\text{erf}(x)) = \text{erfinv}(1 - \text{erfc}(x)) = \text{erfcinv}(1 - \text{erf}(x)) = \text{erfcinv}(\text{erfc}(x)) = x$
- $\text{erfinv}(-\text{erf}(x)) = \text{erfinv}(\text{erfc}(x) - 1) = \text{erfcinv}(1 + \text{erf}(x)) = \text{erfcinv}(2 - \text{erfc}(x)) = -x$

For any value x , the toolbox applies these simplification rules:

- $\text{erfcinv}(x) = \text{erfinv}(1 - x)$
- $\text{erfinv}(-x) = -\text{erfinv}(x)$
- $\text{erfcinv}(2 - x) = -\text{erfcinv}(x)$
- $\text{erf}(\text{erfinv}(x)) = \text{erfc}(\text{erfcinv}(x)) = x$
- $\text{erf}(\text{erfcinv}(x)) = \text{erfc}(\text{erfinv}(x)) = 1 - x$

References

- [1] Gautschi, W. "Error Function and Fresnel Integrals." *Handbook of Mathematical Functions with Formulas, Graphs, and Mathematical Tables*. (M. Abramowitz and I. A. Stegun, eds.). New York: Dover, 1972.

See Also

`erf` | `erfc` | `erfi` | `erfinv`

Introduced in R2012a

erfi

Imaginary error function

Syntax

```
erfi(x)
```

Description

`erfi(x)` returns the imaginary error function on page 4-375 of x . If x is a vector or a matrix, `erfi(x)` returns the imaginary error function of each element of x .

Examples

Imaginary Error Function for Floating-Point and Symbolic Numbers

Depending on its arguments, `erfi` can return floating-point or exact symbolic results.

Compute the imaginary error function for these numbers. Because these numbers are not symbolic objects, you get floating-point results.

```
s = [erfi(1/2), erfi(1.41), erfi(sqrt(2))]  
  
s =  
    0.6150    3.7382    3.7731
```

Compute the imaginary error function for the same numbers converted to symbolic objects. For most symbolic (exact) numbers, `erfi` returns unresolved symbolic calls.

```
s = [erfi(sym(1/2)), erfi(sym(1.41)), erfi(sqrt(sym(2)))]  
  
s =  
[ erfi(1/2), erfi(141/100), erfi(2^(1/2))]
```

Use `vpa` to approximate this result with the 10-digit accuracy:

```
vpa(s, 10)  
  
ans =  
[ 0.6149520947, 3.738199581, 3.773122512]
```

Imaginary Error Function for Variables and Expressions

Compute the imaginary error function for x and $\sin(x) + x \cdot \exp(x)$. For most symbolic variables and expressions, `erfi` returns unresolved symbolic calls.

```
syms x  
f = sin(x) + x*exp(x);  
erfi(x)  
erfi(f)  
  
ans =  
erfi(x)
```

```
ans =
erfi(sin(x) + x*exp(x))
```

Imaginary Error Function for Vectors and Matrices

If the input argument is a vector or a matrix, `erfi` returns the imaginary error function for each element of that vector or matrix.

Compute the imaginary error function for elements of matrix `M` and vector `V`:

```
M = sym([0 inf; 1/3 -inf]);
V = sym([1; -i*inf]);
erfi(M)
erfi(V)
```

```
ans =
[      0,  Inf]
[ erfi(1/3), -Inf]
```

```
ans =
  erfi(1)
    -1i
```

Special Values of Imaginary Error Function

Compute the imaginary error function for $x = 0$, $x = \infty$, and $x = -\infty$. Use `sym` to convert `0` and infinities to symbolic objects. The imaginary error function has special values for these parameters:

```
[erfi(sym(0)), erfi(sym(inf)), erfi(sym(-inf))]
```

```
ans =
[ 0, Inf, -Inf]
```

Compute the imaginary error function for complex infinities. Use `sym` to convert complex infinities to symbolic objects:

```
[erfi(sym(i*inf)), erfi(sym(-i*inf))]
```

```
ans =
[ 1i, -1i]
```

Handling Expressions That Contain Imaginary Error Function

Many functions, such as `diff` and `int`, can handle expressions containing `erfi`.

Compute the first and second derivatives of the imaginary error function:

```
syms x
diff(erfi(x), x)
diff(erfi(x), x, 2)
```

```
ans =
(2*exp(x^2))/pi^(1/2)
```

```
ans =
(4*x*exp(x^2))/pi^(1/2)
```

Compute the integrals of these expressions:

```
int(erfi(x), x)
int(erfi(log(x)), x)
```

```
ans =
x*erfi(x) - exp(x^2)/pi^(1/2)
```

```
ans =
x*erfi(log(x)) - int((2*exp(log(x)^2))/pi^(1/2), x)
```

Plot Imaginary Error Function

Plot the imaginary error function on the interval from -2 to 2.

```
syms x
fplot(erfi(x),[-2,2])
grid on
```

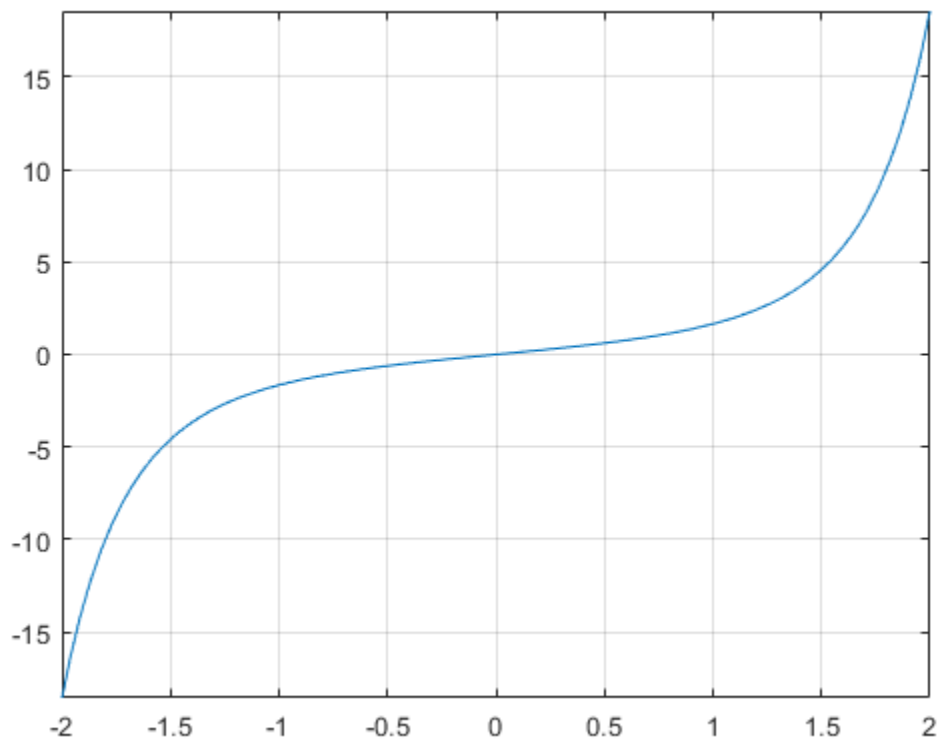

Input Arguments

x — Input

floating-point number | symbolic number | symbolic variable | symbolic expression | symbolic function
| symbolic vector | symbolic matrix

Input, specified as a floating-point or symbolic number, variable, expression, function, vector, or matrix.

More About

Imaginary Error Function

The imaginary error function is defined as:

$$\operatorname{erfi}(x) = -i \operatorname{erf}(ix) = \frac{2}{\sqrt{\pi}} \int_0^x e^{t^2} dt$$

Tips

- `erfi` returns special values for these parameters:
 - `erfi(0) = 0`
 - `erfi(inf) = inf`
 - `erfi(-inf) = -inf`
 - `erfi(i*inf) = i`
 - `erfi(-i*inf) = -i`

See Also

`erf` | `erfc` | `erfcinv` | `erfinv` | `vpa`

Introduced in R2013a

erfinv

Inverse error function

Syntax

```
erfinv(X)
```

Description

`erfinv(X)` computes the inverse error function on page 4-379 of X . If X is a vector or a matrix, `erfinv(X)` computes the inverse error function of each element of X .

Examples

Inverse Error Function for Floating-Point and Symbolic Numbers

Depending on its arguments, `erfinv` can return floating-point or exact symbolic results.

Compute the inverse error function for these numbers. Because these numbers are not symbolic objects, you get floating-point results:

```
A = [erfinv(1/2), erfinv(0.33), erfinv(-1/3)]
```

```
A =  
    0.4769    0.3013   -0.3046
```

Compute the inverse error function for the same numbers converted to symbolic objects. For most symbolic (exact) numbers, `erfinv` returns unresolved symbolic calls:

```
symA = [erfinv(sym(1)/2), erfinv(sym(0.33)), erfinv(sym(-1)/3)]
```

```
symA =  
[ erfinv(1/2), erfinv(33/100), -erfinv(1/3)]
```

Use `vpa` to approximate symbolic results with the required number of digits:

```
d = digits(10);  
vpa(symA)  
digits(d)
```

```
ans =  
[ 0.4769362762, 0.3013321461, -0.3045701942]
```

Inverse Error Function for Variables and Expressions

For most symbolic variables and expressions, `erfinv` returns unresolved symbolic calls.

Compute the inverse error function for x and $\sin(x) + x \cdot \exp(x)$. For most symbolic variables and expressions, `erfinv` returns unresolved symbolic calls:

```
syms x  
f = sin(x) + x*exp(x);
```

```

erfinv(x)
erfinv(f)

ans =
erfinv(x)

ans =
erfinv(sin(x) + x*exp(x))

```

Inverse Error Function for Vectors and Matrices

If the input argument is a vector or a matrix, `erfinv` returns the inverse error function for each element of that vector or matrix.

Compute the inverse error function for elements of matrix `M` and vector `V`:

```

M = sym([0 1 + i; 1/3 1]);
V = sym([-1; inf]);
erfinv(M)
erfinv(V)

ans =
      0, NaN
[ erfinv(1/3), Inf]

ans =
-Inf
NaN

```

Special Values of Inverse Complementary Error Function

`erfinv` returns special values for particular parameters.

Compute the inverse error function for $x = -1$, $x = 0$, and $x = 1$. The inverse error function has special values for these parameters:

```

[erfinv(-1), erfinv(0), erfinv(1)]

ans =
-Inf      0      Inf

```

Handling Expressions That Contain Inverse Complementary Error Function

Many functions, such as `diff` and `int`, can handle expressions containing `erfinv`.

Compute the first and second derivatives of the inverse error function:

```

syms x
diff(erfinv(x), x)
diff(erfinv(x), x, 2)

ans =
(pi^(1/2)*exp(erfinv(x)^2))/2

ans =
(pi*exp(2*erfinv(x)^2)*erfinv(x))/2

```

Compute the integral of the inverse error function:

```
int(erfinv(x), x)
ans =
-exp(-erfinv(x)^2)/pi^(1/2)
```

Plot Inverse Error Function

Plot the inverse error function on the interval from -1 to 1.

```
syms x
fplot(erfinv(x), [-1,1])
grid on
```

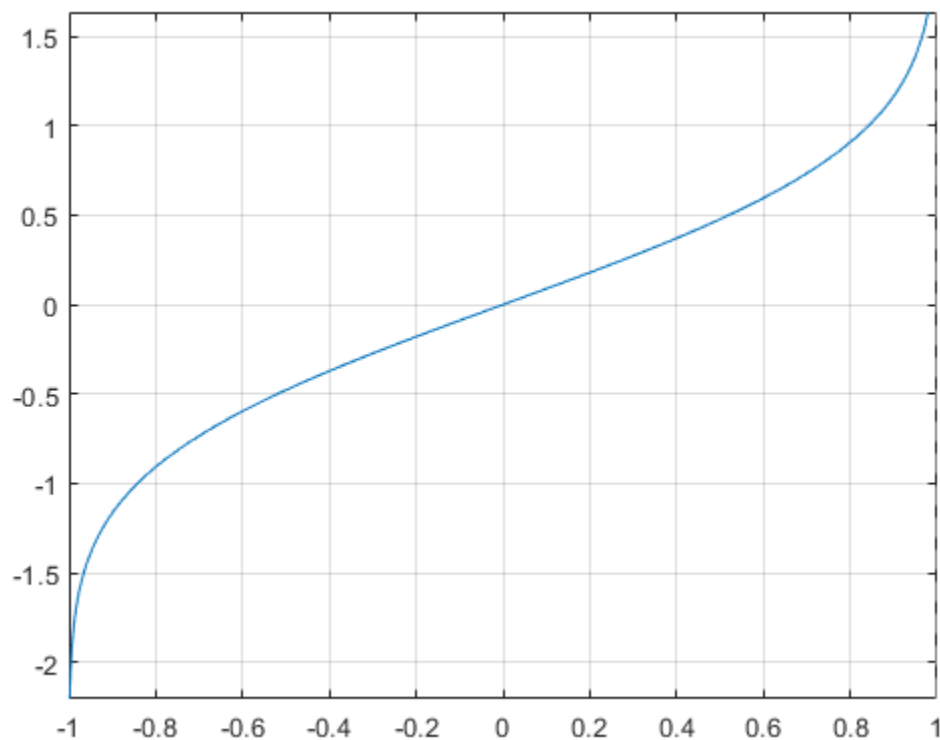

Input Arguments

X — Input

symbolic number | symbolic variable | symbolic expression | symbolic function | symbolic vector | symbolic matrix

Input, specified as a symbolic number, variable, expression, or function, or as a vector or matrix of symbolic numbers, variables, expressions, or functions.

More About

Inverse Error Function

The inverse error function is defined as $\text{erf}^{-1}(x)$, such that $\text{erf}(\text{erf}^{-1}(x)) = \text{erf}^{-1}(\text{erf}(x)) = x$. Here

$$\text{erf}(x) = \frac{2}{\sqrt{\pi}} \int_0^x e^{-t^2} dt$$

is the error function.

Tips

- Calling `erfinv` for a number that is not a symbolic object invokes the MATLAB `erfinv` function. This function accepts real arguments only. If you want to compute the inverse error function for a complex number, use `sym` to convert that number to a symbolic object, and then call `erfinv` for that symbolic object.
- If $x < -1$ or $x > 1$, or if x is complex, then `erfinv(x)` returns NaN.

Algorithms

The toolbox can simplify expressions that contain error functions and their inverses. For real values x , the toolbox applies these simplification rules:

- $\text{erfinv}(\text{erf}(x)) = \text{erfinv}(1 - \text{erfc}(x)) = \text{erfcinv}(1 - \text{erf}(x)) = \text{erfcinv}(\text{erfc}(x)) = x$
- $\text{erfinv}(-\text{erf}(x)) = \text{erfinv}(\text{erfc}(x) - 1) = \text{erfcinv}(1 + \text{erf}(x)) = \text{erfcinv}(2 - \text{erfc}(x)) = -x$

For any value x , the toolbox applies these simplification rules:

- $\text{erfcinv}(x) = \text{erfinv}(1 - x)$
- $\text{erfinv}(-x) = -\text{erfinv}(x)$
- $\text{erfcinv}(2 - x) = -\text{erfcinv}(x)$
- $\text{erf}(\text{erfinv}(x)) = \text{erfc}(\text{erfcinv}(x)) = x$
- $\text{erf}(\text{erfcinv}(x)) = \text{erfc}(\text{erfinv}(x)) = 1 - x$

References

- [1] Gautschi, W. "Error Function and Fresnel Integrals." *Handbook of Mathematical Functions with Formulas, Graphs, and Mathematical Tables*. (M. Abramowitz and I. A. Stegun, eds.). New York: Dover, 1972.

See Also

`erf` | `erfc` | `erfcinv` | `erfi`

Introduced in R2012a

euler

Euler numbers and polynomials

Syntax

```
euler(n)
euler(n,x)
```

Description

`euler(n)` returns the n th Euler number on page 4-383.

`euler(n,x)` returns the n th Euler polynomial on page 4-383.

Examples

Euler Numbers with Odd and Even Indices

The Euler numbers with even indices alternate the signs. Any Euler number with an odd index is 0.

Compute the even-indexed Euler numbers with the indices from 0 to 10:

```
euler(0:2:10)
```

```
ans =
      1      -1      5     -61...
    1385   -50521
```

Compute the odd-indexed Euler numbers with the indices from 1 to 11:

```
euler(1:2:11)
```

```
ans =
      0      0      0      0      0      0
```

Euler Polynomials

For the Euler polynomials, use `euler` with two input arguments.

Compute the first, second, and third Euler polynomials in variables x , y , and z , respectively:

```
syms x y z
euler(1, x)
euler(2, y)
euler(3, z)
```

```
ans =
x - 1/2
```

```
ans =
y^2 - y
```

```
ans =
z^3 - (3*z^2)/2 + 1/4
```

If the second argument is a number, `euler` evaluates the polynomial at that number. Here, the result is a floating-point number because the input arguments are not symbolic numbers:

```
euler(2, 1/3)
```

```
ans =
-0.2222
```

To get the exact symbolic result, convert at least one number to a symbolic object:

```
euler(2, sym(1/3))
```

```
ans =
-2/9
```

Plot Euler Polynomials

Plot the first six Euler polynomials.

```
syms x
fplot(euler(0:5, x), [-1 2])
title('Euler Polynomials')
grid on
```

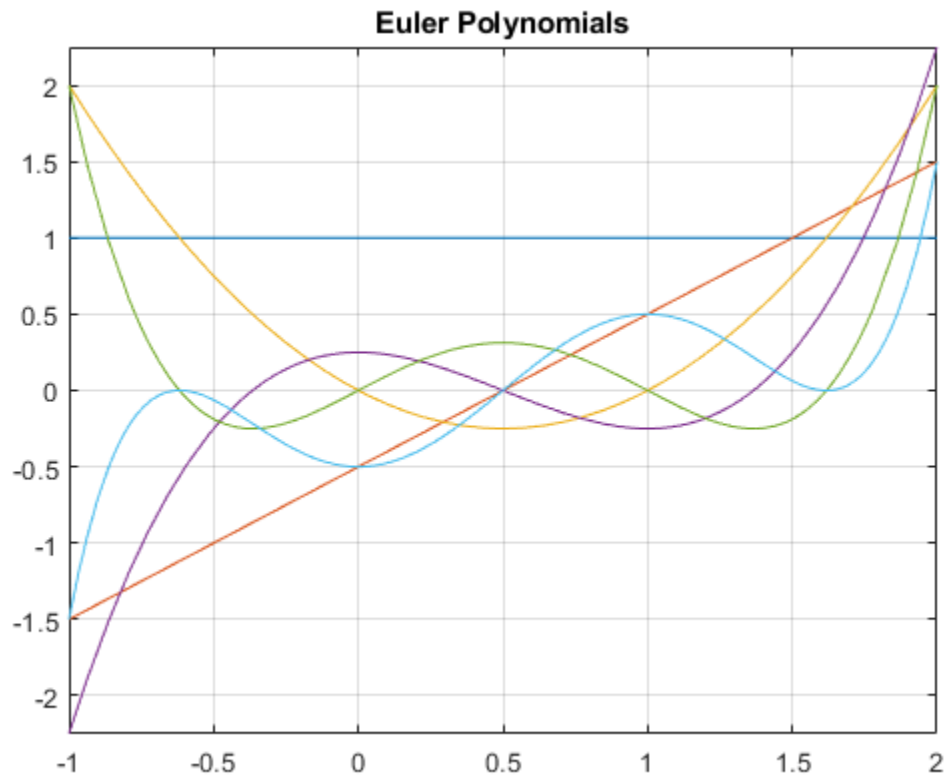

Handle Expressions Containing Euler Polynomials

Many functions, such as `diff` and `expand`, can handle expressions containing `euler`.

Find the first and second derivatives of the Euler polynomial:

```
syms n x
diff(euler(n,x^2), x)

ans =
2*n*x*euler(n - 1, x^2)

diff(euler(n,x^2), x, x)

ans =
2*n*euler(n - 1, x^2) + 4*n*x^2*euler(n - 2, x^2)*(n - 1)
```

Expand these expressions containing the Euler polynomials:

```
expand(euler(n, 2 - x))

ans =
2*(1 - x)^n - (-1)^n*euler(n, x)

expand(euler(n, 2*x))

ans =
(2*2^n*bernoulli(n + 1, x + 1/2))/(n + 1) - ...
(2*2^n*bernoulli(n + 1, x))/(n + 1)
```

Input Arguments

n — Index of the Euler number or polynomial

nonnegative integer | symbolic nonnegative integer | symbolic variable | symbolic expression | symbolic function | symbolic vector | symbolic matrix

Index of the Euler number or polynomial, specified as a nonnegative integer, symbolic nonnegative integer, variable, expression, function, vector, or matrix. If `n` is a vector or matrix, `euler` returns Euler numbers or polynomials for each element of `n`. If one input argument is a scalar and the other one is a vector or a matrix, `euler(n, x)` expands the scalar into a vector or matrix of the same size as the other argument with all elements equal to that scalar.

x — Polynomial variable

symbolic variable | symbolic expression | symbolic function | symbolic vector | symbolic matrix

Polynomial variable, specified as a symbolic variable, expression, function, vector, or matrix. If `x` is a vector or matrix, `euler` returns Euler numbers or polynomials for each element of `x`. When you use the `euler` function to find Euler polynomials, at least one argument must be a scalar or both arguments must be vectors or matrices of the same size. If one input argument is a scalar and the other one is a vector or a matrix, `euler(n, x)` expands the scalar into a vector or matrix of the same size as the other argument with all elements equal to that scalar.

More About

Euler Polynomials

The Euler polynomials are defined as follows:

$$\frac{2e^{xt}}{e^t + 1} = \sum_{n=0}^{\infty} \text{euler}(n, x) \frac{t^n}{n!}$$

Euler Numbers

The Euler numbers are defined in terms of Euler polynomials as follows:

$$\text{euler}(n) = 2^n \text{euler}\left(n, \frac{1}{2}\right)$$

Tips

- For the other meaning of Euler's number, $e = 2.71828\dots$, call `exp(1)` to return the double-precision representation. For the exact representation of Euler's number e , call `exp(sym(1))`.
- For the Euler-Mascheroni constant, see `eulergamma`.

See Also

`bernoulli` | `eulergamma`

Introduced in R2014a

eulergamma

Euler-Mascheroni constant

Syntax

```
eulergamma
```

Description

`eulergamma` represents the Euler-Mascheroni constant on page 4-385. To get a floating-point approximation with the current precision set by `digits`, use `vpa(eulergamma)`.

Examples

Represent and Numerically Approximate the Euler-Mascheroni Constant

Represent the Euler-Mascheroni constant using `eulergamma`, which returns the symbolic form `eulergamma`.

```
eulergamma
```

```
ans =  
eulergamma
```

Use `eulergamma` in symbolic calculations. Numerically approximate your result with `vpa`.

```
a = eulergamma;  
g = a^2 + log(a)  
gVpa = vpa(g)  
  
g =  
log(eulergamma) + eulergamma^2  
gVpa =  
-0.21636138917392614801928563244766
```

Find the double-precision approximation of the Euler-Mascheroni constant using `double`.

```
double(eulergamma)  
  
ans =  
0.5772
```

Show Relation of Euler-Mascheroni Constant to Gamma Functions

Show the relations between the Euler-Mascheroni constant γ , digamma function Ψ , and gamma function Γ .

Show that $\gamma = -\Psi(1)$.

```
-psi(sym(1))  
  
ans =  
eulergamma
```

Show that $\gamma = -\Gamma'(x)|_{x=1}$.

```
syms x
-subs(diff(gamma(x)), x, 1)

ans =
eulergamma
```

More About

Euler-Mascheroni Constant

The Euler-Mascheroni constant is defined as follows:

$$\gamma = \lim_{n \rightarrow \infty} \left(\sum_{k=1}^n \frac{1}{k} - \ln(n) \right)$$

Tips

- For the value $e = 2.71828\dots$, called Euler's number, use `exp(1)` to return the double-precision representation. For the exact representation of Euler's number e , call `exp(sym(1))`.
- For the other meaning of Euler's numbers and for Euler's polynomials, see `euler`.

See Also

`coshint` | `euler`

Introduced in R2014a

eulerPhi

Euler phi function

Syntax

```
p = eulerPhi(n)
```

Description

`p = eulerPhi(n)` evaluates the Euler phi function on page 4-388 or (also known as the totient function) for a positive integer n .

Examples

Multiplicative Property of Euler Phi Function

Compute the Euler phi function $\phi(n)$ for the integer $n = 35$.

```
p = eulerPhi(35)
```

```
p = 24
```

The Euler phi function satisfies the multiplicative property $\phi(xy) = \phi(x)\phi(y)$ if the two integers x and y are relatively prime (also known as coprime). The integer factorization of 35 is 7 and 5, which are relatively prime. Show that $\phi(35)$ satisfies the multiplicative property.

Calculate $\phi(x)$ and $\phi(y)$ for the two factors.

```
px = eulerPhi(7)
```

```
px = 6
```

```
py = eulerPhi(5)
```

```
py = 4
```

Verify that `px` and `py` satisfy the multiplicative property.

```
p = px*py
```

```
p = 24
```

Euler's Product Formula

If a positive integer n has prime factorization $n = p_1^{k_1} p_2^{k_2} \dots p_r^{k_r}$ with distinct prime factors p_1, p_2, \dots, p_r , then the Euler phi function satisfies the product formula

$$\phi(n) = n \left(1 - \frac{1}{p_1}\right) \left(1 - \frac{1}{p_2}\right) \dots \left(1 - \frac{1}{p_r}\right).$$

The integer $n = 36$ has distinct prime factors 2 and 3. Show that $\phi(36)$ satisfies the Euler's product formula.

Declare 36 as a symbolic number and evaluate $\phi(36)$.

```
n = sym(36)
```

```
n = 36
```

List the prime factors of 36.

```
f_n = factor(n)
```

```
f_n = (2 2 3 3)
```

Substitute the prime factors 2 and 3 into the product formula.

```
p_product = n*(1-1/2)*(1-1/3)
```

```
p_product = 12
```

Euler's Theorem

Euler's theorem states that $a^{\phi(n)} \equiv 1 \pmod{n}$ if and only if the two positive integers a and n are relatively prime. Show that the Euler phi function $\phi(n)$ satisfies Euler's theorem for the integers $a = 15$ and $n = 4$.

```
a = 15;
```

```
n = 4;
```

```
isCongruent = powermod(a,eulerPhi(n),n) == mod(1,n)
```

```
isCongruent = logical
```

```
1
```

Confirm that a and n are relatively prime.

```
g = gcd(a,n)
```

```
g = 1
```

Mean Value of Euler Phi Function Results

Calculate the Euler phi function $\phi(n)$ for the integers n from 1 to 1000.

```
P = eulerPhi(1:1000);
```

Find the mean value of $\phi(n)/n$.

```
Pave = mean(P./(1:1000))
```

```
Pave = 0.6082
```

Input Arguments

n — Input

number | vector | matrix | array | symbolic number | symbolic array

Input, specified as a number, vector, matrix, array, symbolic number, or symbolic array. The elements of n must be positive integers.

Data Types: single | double | sym

More About

Euler Phi Function

The Euler phi function $\phi(n)$ computes the number of integers between 1 and n that are relatively prime (also known as coprime) to n . Two integers are relatively prime if there is no integer greater than one that divides them both. In other words, their greatest common divisor is one.

References

[1] Redmond, D. *Number Theory: An Introduction to Pure and Applied Mathematics*. New York: Marcel Dekker, 1996.

See Also

isprime | primes

Introduced in R2020a

evalin

(Not recommended) Evaluate MuPAD expressions without specifying their arguments

Note `evalin(symengine,...)` is not recommended. Use equivalent Symbolic Math Toolbox™ functions that replace MuPAD® functions instead. For more information, see “Compatibility Considerations”.

Syntax

```
result = evalin(symengine,MuPAD_expression)
[result,status] = evalin(symengine,MuPAD_expression)
```

Description

`result = evalin(symengine,MuPAD_expression)` evaluates the MuPAD expression `MuPAD_expression`, and returns `result` as a symbolic object. If `MuPAD_expression` throws an error in MuPAD, then this syntax throws an error in MATLAB.

`[result,status] = evalin(symengine,MuPAD_expression)` lets you catch errors thrown by MuPAD. This syntax returns the error status in `status` and the error message in `result` if `status` is nonzero. If `status` is 0, `result` is a symbolic object; otherwise, it is a character vector.

Examples

Perform MuPAD Command

Compute the discriminant of the following polynomial:

```
evalin(symengine,'polylib::discrim(a*x^2+b*x+c,x)')
ans =
  b^2 - 4*a*c
```

Input Arguments

MuPAD_expression — Input

character vector

Character vector containing a MuPAD expression.

Output Arguments

result — Computation result

character vector | symbolic object

Computation result returned as a symbolic object or character vector containing a MuPAD error message.

status — Error status

integer

Error status returned as an integer. If F with the arguments x_1, \dots, x_n executes without errors, the error status is 0.

Tips

- Results returned by `evalin` can differ from the results that you get using a MuPAD notebook directly. The reason is that `evalin` sets a lower level of evaluation to achieve better performance.
- `evalin` does not open a MuPAD notebook, and therefore, you cannot use this function to access MuPAD graphics capabilities.

Compatibility Considerations**`evalin(symengine, ...)` is not recommended***Not recommended starting in R2018b*

Symbolic Math Toolbox includes operations and functions for symbolic math expressions that parallel MATLAB functionality for numeric values. Unlike MuPAD functionality, Symbolic Math Toolbox functions enable you to work in familiar interfaces, such as the MATLAB Command Window or Live Editor, which offer a smooth workflow and are optimized for usability.

Therefore, instead of passing MuPAD expressions to `evalin`, use the equivalent Symbolic Math Toolbox functionality to work with symbolic math expressions. For a list of available functions, see Symbolic Math Toolbox functions list.

To convert a MuPAD notebook file to a MATLAB live script file, see `convertMuPADNotebook`.

If you cannot find the Symbolic Math Toolbox equivalent for MuPAD functionality, contact MathWorks Technical Support.

Although the use of `evalin` is not recommended, there are no plans to remove it at this time.

Introduced in R2008b

expand

Expand expressions and simplify inputs of functions by using identities

Syntax

```
expand(S)
expand(S, Name, Value)
```

Description

`expand(S)` multiplies all parentheses in S , and simplifies inputs to functions such as $\cos(x + y)$ by applying standard identities.

`expand(S, Name, Value)` uses additional options specified by one or more name-value pair arguments. For example, specifying 'IgnoreAnalyticConstraints' as true uses convenient identities to simplify the input.

Examples

Expand Symbolic Expression

```
syms x
p = (x - 2)*(x - 4);
expand(p)

ans =
x^2 - 6*x + 8
```

Expand Trigonometric Expression

Expand the trigonometric expression $\cos(x + y)$. Simplify the \cos function input $x + y$ to x or y by applying standard identities.

```
syms x y
expand(cos(x + y))

ans =
cos(x)*cos(y) - sin(x)*sin(y)
```

Expand Exponential Expression

Expand $e^{(a + b)^2}$. Simplify the \exp function input, $(a + b)^2$, by applying standard identities.

```
syms a b
f = exp((a + b)^2);
expand(f)
```

```
ans =  
exp(a^2)*exp(b^2)*exp(2*a*b)
```

Expand Vector of Expressions

Expand expressions in a vector. Simplify the inputs to functions in the expressions by applying identities.

```
syms t  
V = [sin(2*t), cos(2*t)];  
expand(V)  
  
ans =  
[ 2*cos(t)*sin(t), 2*cos(t)^2 - 1]
```

Expand Only Arithmetic and Suppress Expansion of Functions

By default, `expand` both expands terms raised to powers and expands functions by applying identities that simplify inputs to the functions. Expand only terms raised to powers and suppress expansion of functions by using `'ArithmeticOnly'`.

Expand $(\sin(3x) - 1)^2$. By default, `expand` will expand the power 2 and simplify the `sin` input $3x$ to x .

```
syms x  
f = (sin(3*x) - 1)^2;  
expand(f)  
  
ans =  
2*sin(x) + sin(x)^2 - 8*cos(x)^2*sin(x) - 8*cos(x)^2*sin(x)^2...  
+ 16*cos(x)^4*sin(x)^2 + 1
```

Suppress expansion of functions, such as $\sin(3x)$, by setting `ArithmeticOnly` to `true`.

```
expand(f, 'ArithmeticOnly', true)  
  
ans =  
sin(3*x)^2 - 2*sin(3*x) + 1
```

Simplify Log Input by Removing Constraints

Simplify the input of `log` function calls. By default, `expand` does not simplify logarithm input because the identities used are not valid for complex values of variables.

```
syms a b c  
f = log((a*b/c)^2);  
expand(f)  
  
ans =  
log((a^2*b^2)/c^2)
```

Apply identities to simplify the input of logarithms by setting `'IgnoreAnalyticConstraints'` to `true`.

```
expand(f, 'IgnoreAnalyticConstraints', true)
```

```
ans =
  2*log(a) + 2*log(b) - 2*log(c)
```

Input Arguments

S — Input

number | vector | matrix | array | symbolic number | symbolic variable | symbolic array | symbolic function | symbolic expression

Input, specified as a number, vector, matrix, or array, or a symbolic number, variable, array, function, or expression.

Name-Value Pair Arguments

Specify optional comma-separated pairs of **Name**, **Value** arguments. **Name** is the argument name and **Value** is the corresponding value. **Name** must appear inside quotes. You can specify several name and value pair arguments in any order as **Name1**, **Value1**, ..., **NameN**, **ValueN**.

Example: `expand(S, 'ArithmeticOnly', true)`

ArithmeticOnly — Expand only algebraic expressions

false (default) | true

Expand only algebraic expressions, specified as the comma-separated pair consisting of 'ArithmeticOnly' and true or false. If the value is true, the function expands the arithmetic part of an expression without expanding trigonometric, hyperbolic, logarithmic, and special functions. This option does not prevent the expansion of powers and roots.

IgnoreAnalyticConstraints — Use convenient identities for simplification

false (default) | true

Use convenient identities for simplification, specified as the comma-separated pair consisting of 'IgnoreAnalyticConstraints' and true or false. If the value is true, expand applies identities that are convenient but do not hold for all values of variables. This option can let expand return simpler results. See "Algorithms" on page 4-393. Setting this option can lead to results that are not equivalent to the initial expression.

Algorithms

When you use 'IgnoreAnalyticConstraints', expand applies these rules.

- $\log(a) + \log(b) = \log(a \cdot b)$ for all values of a and b . In particular, the following equality is valid for all values of a , b , and c :

$$(a \cdot b)^c = a^c \cdot b^c.$$
- $\log(a^b) = b \cdot \log(a)$ for all values of a and b . In particular, the following equality is valid for all values of a , b , and c :

$$(a^b)^c = a^{b \cdot c}.$$
- If f and g are standard mathematical functions and $f(g(x)) = x$ for all small positive numbers, $f(g(x)) = x$ is assumed to be valid for all complex x .

- $\log(e^x) = x$
- $\text{asin}(\sin(x)) = x$, $\text{acos}(\cos(x)) = x$, $\text{atan}(\tan(x)) = x$
- $\text{asinh}(\sinh(x)) = x$, $\text{acosh}(\cosh(x)) = x$, $\text{atanh}(\tanh(x)) = x$
- $W_k(x \cdot e^x) = x$ for all values of k

See Also

Functions

`collect` | `combine` | `factor` | `horner` | `numden` | `rewrite` | `simplify` | `simplifyFraction`

Live Editor Tasks

Simplify Symbolic Expression

Topics

“Choose Function to Rearrange Expression” on page 2-104

“Simplify Symbolic Expressions” on page 2-81

“Simplify Symbolic Expressions Using Live Editor Task” on page 2-94

Introduced before R2006a

expint

Exponential integral function

Syntax

```
expint(x)
expint(n,x)
```

Description

`expint(x)` returns the one-argument exponential integral function defined as

$$\text{expint}(x) = \int_x^{\infty} \frac{e^{-t}}{t} dt.$$

`expint(n,x)` returns the two-argument exponential integral function defined as

$$\text{expint}(n,x) = \int_1^{\infty} \frac{e^{-xt}}{t^n} dt.$$

Examples

One-Argument Exponential Integral for Floating-Point and Symbolic Numbers

Compute the exponential integrals for floating-point numbers. Because these numbers are not symbolic objects, you get floating-point results.

```
s = [expint(1/3), expint(1), expint(-2)]
```

```
s =
    0.8289 + 0.0000i    0.2194 + 0.0000i   -4.9542 - 3.1416i
```

Compute the exponential integrals for the same numbers converted to symbolic objects. For positive values x , `expint(x)` returns `-ei(-x)`. For negative values x , it returns `-pi*i - ei(-x)`.

```
s = [expint(sym(1)/3), expint(sym(1)), expint(sym(-2))]
```

```
s =
[ -ei(-1/3), -ei(-1), - ei(2) - pi*1i]
```

Use `vpa` to approximate this result with 10-digit accuracy.

```
vpa(s, 10)
```

```
ans =
[ 0.8288877453, 0.2193839344, - 4.954234356 - 3.141592654i]
```

Two-Argument Exponential Integral for Floating-Point and Symbolic Numbers

When computing two-argument exponential integrals, convert the numbers to symbolic objects.

```
s = [expint(2, sym(1)/3), expint(sym(1), Inf), expint(-1, sym(-2))]
```

```
s =
[ expint(2, 1/3), 0, -exp(2)/4]
```

Use `vpa` to approximate this result with 25-digit accuracy.

```
vpa(s, 25)
```

```
ans =
[ 0.4402353954575937050522018, 0, -1.847264024732662556807607]
```

Two-Argument Exponential Integral with Nonpositive First Argument

Compute two-argument exponential integrals. If n is a nonpositive integer, then `expint(n, x)` returns an explicit expression in the form $\exp(-x)*p(1/x)$, where p is a polynomial of degree $1 - n$.

```
syms x
expint(0, x)
expint(-1, x)
expint(-2, x)
```

```
ans =
exp(-x)/x
```

```
ans =
exp(-x)*(1/x + 1/x^2)
```

```
ans =
exp(-x)*(1/x + 2/x^2 + 2/x^3)
```

Derivatives of Exponential Integral

Compute the first, second, and third derivatives of a one-argument exponential integral.

```
syms x
diff(expint(x), x)
diff(expint(x), x, 2)
diff(expint(x), x, 3)
```

```
ans =
-exp(-x)/x
```

```
ans =
exp(-x)/x + exp(-x)/x^2
```

```
ans =
- exp(-x)/x - (2*exp(-x))/x^2 - (2*exp(-x))/x^3
```

Compute the first derivatives of a two-argument exponential integral.

```
syms n x
diff(expint(n, x), x)
diff(expint(n, x), n)
```

```
ans =
-expint(n - 1, x)
```

```
ans =
- hypergeom([1 - n, 1 - n], [2 - n, 2 - n],...
    -x)/(n - 1)^2 - (x^(n - 1)*pi*(psi(n) - ...
    log(x) + pi*cot(pi*n)))/(sin(pi*n)*gamma(n))
```

Input Arguments

x — Input

symbolic number | symbolic variable | symbolic expression | symbolic function | symbolic vector | symbolic matrix

Input specified as a symbolic number, variable, expression, function, vector, or matrix.

n — Input

symbolic number | symbolic variable | symbolic expression | symbolic function | symbolic vector | symbolic matrix

Input specified as a symbolic number, variable, expression, function, vector, or matrix. When you compute the two-argument exponential integral function, at least one argument must be a scalar.

Tips

- Calling `expint` for numbers that are not symbolic objects invokes the MATLAB `expint` function. This function accepts one argument only. To compute the two-argument exponential integral, use `sym` to convert the numbers to symbolic objects, and then call `expint` for those symbolic objects. You can approximate the results with floating-point numbers using `vpa`.
- The following values of the exponential integral differ from those returned by the MATLAB `expint` function: `expint(sym(Inf)) = 0`, `expint(-sym(Inf)) = -Inf`, `expint(sym(NaN)) = NaN`.
- For positive real x , $\text{expint}(x) = -\text{ei}(-x)$. For negative real x , $\text{expint}(x) = -\pi i - \text{ei}(-x)$.
- If one input argument is a scalar and the other argument is a vector or a matrix, then `expint(n,x)` expands the scalar into a vector or matrix of the same size as the other argument with all elements equal to that scalar.

Algorithms

The relation between `expint` and `ei` is

$$\text{expint}(1,-x) = \text{ei}(x) + (\ln(x) - \ln(1/x))/2 - \ln(-x)$$

Both functions $\text{ei}(x)$ and $\text{expint}(1,x)$ have a logarithmic singularity at the origin and a branch cut along the negative real axis. The `ei` function is not continuous when approached from above or below this branch cut.

The `expint` function is related to the upper incomplete gamma function `igamma` as

$$\text{expint}(n,x) = (x^{n-1}) * \text{igamma}(1-n,x)$$

See Also

`ei` | `expint` | `vpa`

Introduced in R2013a

expm

Matrix exponential

Syntax

`R = expm(A)`

Description

`R = expm(A)` computes the matrix exponential on page 4-399 of the square matrix `A`.

Examples

Matrix Exponential

Compute the matrix exponential for the 2-by-2 matrix and simplify the result.

```

syms x
A = [0 x; -x 0];
simplify(expm(A))

ans =
[ cos(x), sin(x)]
[ -sin(x), cos(x)]

```

Input Arguments

A — Input matrix

square matrix

Input matrix, specified as a square symbolic matrix.

Output Arguments

R — Resulting matrix

symbolic matrix

Resulting function, returned as a symbolic matrix.

More About

Matrix Exponential

The matrix exponential e^A of matrix A is

$$e^A = \sum_{k=0}^{\infty} \frac{1}{k!} A^k = 1 + A + \frac{A^2}{2} + \dots$$

See Also

eig | funm | jordan | logm | sqrtm

Introduced before R2006a

ezcontour

Contour plotter

Note ezcontour is not recommended. Use fcontour instead.

Syntax

```
ezcontour(f)
ezcontour(f, domain)
ezcontour( ____, n)
```

Description

ezcontour(f) plots the contour lines of $f(x,y)$, where f is a symbolic expression that represents a mathematical function of two variables, such as x and y . ezcontour automatically adds a title and axis labels.

The function f is plotted over the default domain $-2\pi < x < 2\pi$, $-2\pi < y < 2\pi$. MATLAB software chooses the computational grid according to the amount of variation that occurs; if the function f is not defined (singular) for points on the grid, then these points are not plotted.

ezcontour(f, domain) plots $f(x,y)$ over the specified domain. domain can be either a 4-by-1 vector [xmin, xmax, ymin, ymax] or a 2-by-1 vector [min, max] (where, $min < x < max$, $min < y < max$). If f is a function of the variables u and v (rather than x and y), then the domain endpoints $umin$, $umax$, $vmin$, and $vmax$ are sorted alphabetically. Thus, ezcontour($u^2 - v^3$, [0, 1], [3, 6]) plots the contour lines for $u^2 - v^3$ over $0 < u < 1$, $3 < v < 6$.

ezcontour(____, n) plots f over the default domain using an n -by- n grid. The default value for n is 60.

Examples

Plot Contour Lines of Symbolic Expression

The following mathematical expression defines a function of two variables, x and y .

$$f(x, y) = 3(1 - x)^2 e^{-x^2 - (y+1)^2} - 10\left(\frac{x}{5} - x^3 - y^5\right) e^{-x^2 - y^2} - \frac{1}{3} e^{-(x+1)^2 - y^2}.$$

ezcontour requires a sym argument that expresses this function using MATLAB syntax to represent exponents, natural logs, etc. This function is represented by the symbolic expression

```
syms x y
f = 3*(1-x)^2*exp(-(x^2)-(y+1)^2)...
    - 10*(x/5 - x^3 - y^5)*exp(-x^2-y^2)...
    - 1/3*exp(-(x+1)^2 - y^2);
```

For convenience, this expression is written on three lines.

Pass the sym `f` to `ezcontour` along with a domain ranging from -3 to 3 and specify a computational grid of 49-by-49.

```
ezcontour(f, [-3,3], 49)
```

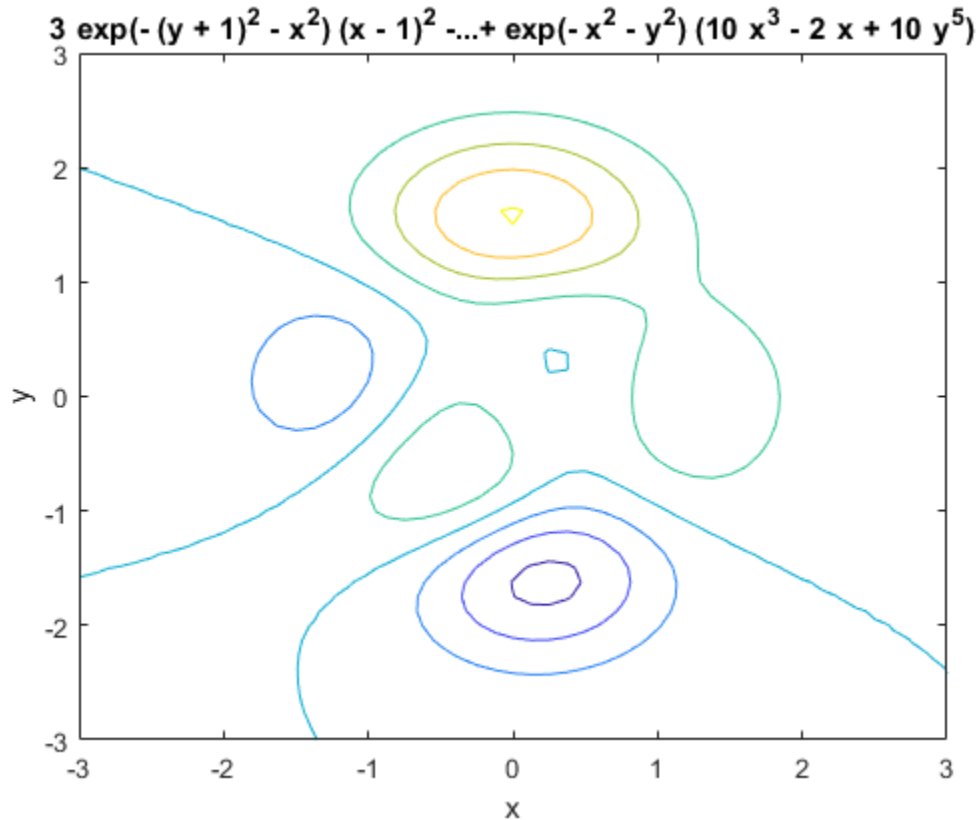

In this particular case, the title is too long to fit at the top of the graph so MATLAB abbreviates the title.

Input Arguments

f — Input

symbolic function | symbolic expression

Input, specified as a symbolic function or expression.

domain — Domain to plot over

symbolic vector

Domain to plot over, specified as a symbolic vector. `domain` is a 4-by-1 vector $[xmin, xmax, ymin, ymax]$ or a 2-by-1 vector $[min, max]$ (where, $min < x < max$, $min < y < max$). If f is a function of the variables u and v (rather than x and y), then the domain endpoints $umin$, $umax$, $vmin$, and $vmax$ are sorted alphabetically

n — grid points

number | symbolic number

Grid points, specified as a number or a symbolic number.

See Also

`contour` | `fcontour` | `fmesh` | `fplot` | `fplot3` | `fsurf`

Introduced before R2006a

ezcontourf

Filled contour plotter

Note ezcontourf is not recommended. Use fcontour instead.

Syntax

```
ezcontourf(f)
ezcontourf(f, domain)
ezcontourf( ____, n)
```

Description

ezcontourf(f) plots the contour lines of $f(x,y)$, where f is a sym that represents a mathematical function of two variables, such as x and y .

The function f is plotted over the default domain $-2\pi < x < 2\pi$, $-2\pi < y < 2\pi$. MATLAB software chooses the computational grid according to the amount of variation that occurs; if the function f is not defined (singular) for points on the grid, then these points are not plotted.

ezcontourf automatically adds a title and axis labels.

ezcontourf(f, domain) plots $f(x,y)$ over the specified domain. domain can be either a 4-by-1 vector $[xmin, xmax, ymin, ymax]$ or a 2-by-1 vector $[min, max]$ (where, $min < x < max$, $min < y < max$). If f is a function of the variables u and v (rather than x and y), then the domain endpoints $umin$, $umax$, $vmin$, and $vmax$ are sorted alphabetically. Thus, ezcontourf($u^2 - v^3$, [0, 1], [3, 6]) plots the contour lines for $u^2 - v^3$ over $0 < u < 1$, $3 < v < 6$.

ezcontourf(____, n) plots f over the default domain using an n -by- n grid. The default value for n is 60.

Examples

Plot Filled Contours

The following mathematical expression defines a function of two variables, x and y .

$$f(x, y) = 3(1 - x)^2 e^{-x^2 - (y+1)^2} - 10\left(\frac{x}{5} - x^3 - y^5\right) e^{-x^2 - y^2} - \frac{1}{3} e^{-(x+1)^2 - y^2}.$$

ezcontourf requires a sym argument that expresses this function using MATLAB syntax to represent exponents, natural logs, etc. This function is represented by the symbolic expression

```
syms x y
f = 3*(1-x)^2*exp(-(x^2)-(y+1)^2)...
    - 10*(x/5 - x^3 - y^5)*exp(-x^2-y^2)...
    - 1/3*exp(-(x+1)^2 - y^2);
```

For convenience, this expression is written on three lines.

Pass the sym `f` to `ezcontourf` along with a domain ranging from -3 to 3 and specify a grid of 49-by-49.

```
ezcontourf(f, [-3,3], 49)
```

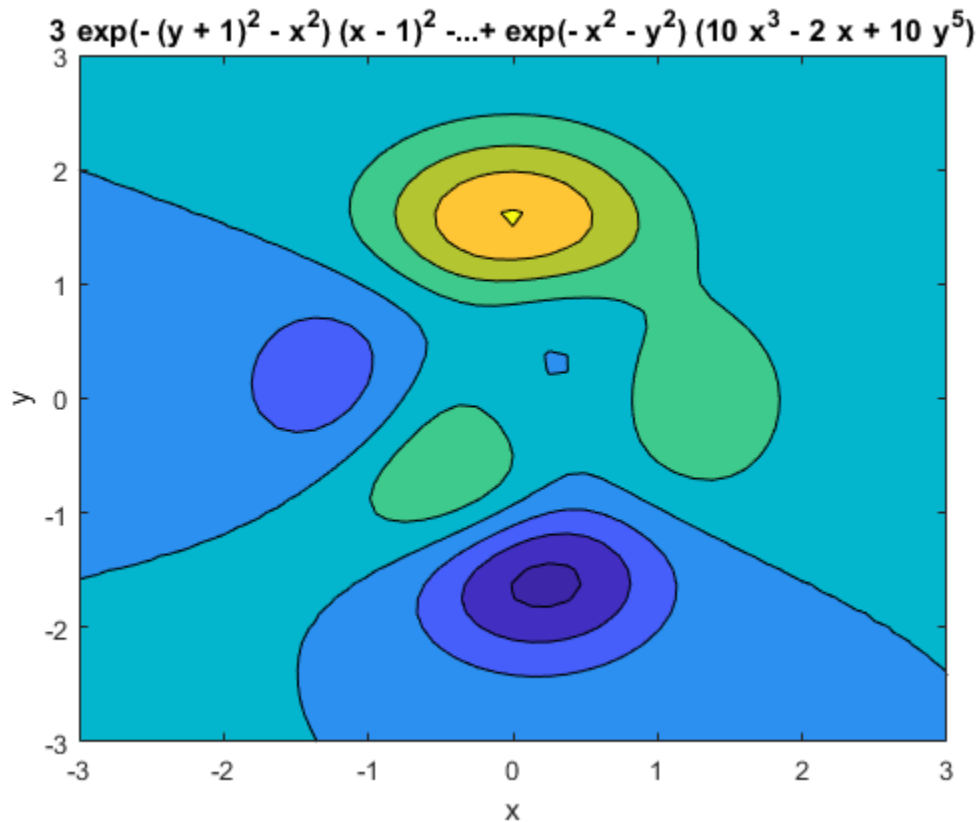

In this particular case, the title is too long to fit at the top of the graph so MATLAB abbreviates the title.

Input Arguments

f — Input

symbolic function | symbolic expression

Input, specified as a symbolic function or expression.

domain — Domain to plot over

symbolic vector

Domain to plot over, specified as a symbolic vector. `domain` is a 4-by-1 vector $[xmin, xmax, ymin, ymax]$ or a 2-by-1 vector $[min, max]$ (where, $min < x < max$, $min < y < max$). If f is a function of the variables u and v (rather than x and y), then the domain endpoints $umin$, $umax$, $vmin$, and $vmax$ are sorted alphabetically

n — grid points

number | symbolic number

Grid points, specified as a number or a symbolic number.

See Also

`contour` | `fcontour` | `fmesh` | `fplot` | `fplot3` | `fsurf`

Introduced before R2006a

ezmesh

3-D mesh plotter

Note ezmesh is not recommended. Use fmesh instead.

Syntax

```
ezmesh(f)
ezmesh(f, domain)
ezmesh(x, y, z)
ezmesh(x, y, z, domain)
ezmesh( ____, n)
ezmesh( ____, 'circ')
```

Description

ezmesh(f) creates a graph of $f(x,y)$, where f is a symbolic expression that represents a mathematical function of two variables, such as x and y .

The function f is plotted over the default domain $-2\pi < x < 2\pi$, $-2\pi < y < 2\pi$. MATLAB software chooses the computational grid according to the amount of variation that occurs; if the function f is not defined (singular) for points on the grid, then these points are not plotted.

ezmesh(f, domain) plots f over the specified domain. domain can be either a 4-by-1 vector [$xmin$, $xmax$, $ymin$, $ymax$] or a 2-by-1 vector [min , max] (where, $min < x < max$, $min < y < max$).

If f is a function of the variables u and v (rather than x and y), then the domain endpoints $umin$, $umax$, $vmin$, and $vmax$ are sorted alphabetically. Thus, ezmesh($u^2 - v^3$, [0, 1], [3, 6]) plots $u^2 - v^3$ over $0 < u < 1$, $3 < v < 6$.

ezmesh(x, y, z) plots the parametric surface $x = x(s,t)$, $y = y(s,t)$, and $z = z(s,t)$ over the square $-2\pi < s < 2\pi$, $-2\pi < t < 2\pi$.

ezmesh(x, y, z, domain) plots the parametric surface using the specified domain.

ezmesh(____, n) plots f over the default domain using an n -by- n grid. The default value for n is 60.

ezmesh(____, 'circ') plots f over a disk centered on the domain.

Examples

3-D Mesh Plot of Symbolic Expression

This example visualizes the function,

$$f(x, y) = xe^{-x^2 - y^2},$$

with a mesh plot drawn on a 40-by-40 grid. The mesh lines are set to a uniform blue color by setting the colormap to a single color.

```
syms x y
ezmesh(x*exp(-x^2-y^2), [-2.5,2.5],40)
colormap([0 0 1])
```

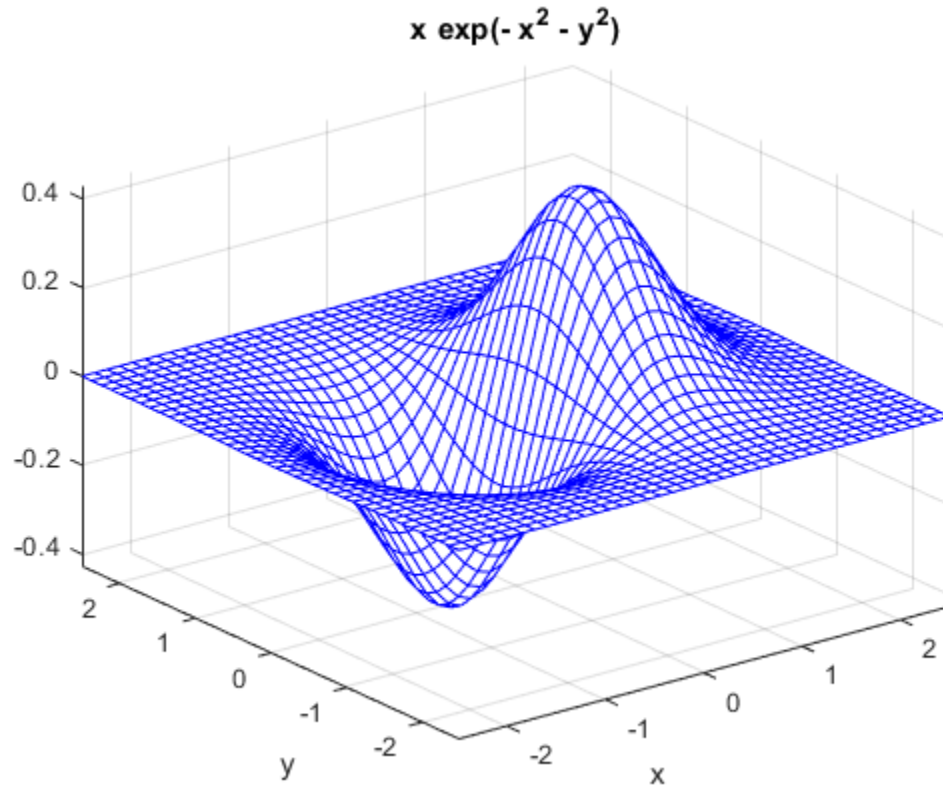

Input Arguments

f – Input

symbolic function | symbolic expression

Input, specified as a symbolic function or expression.

x – Input

symbolic function | symbolic expression

Input, specified as a symbolic function or expression.

y – Input

symbolic function | symbolic expression

Input, specified as a symbolic function or expression.

z – Input

symbolic function | symbolic expression

Input, specified as a symbolic function or expression.

domain — Domain to plot over

symbolic vector

Domain to plot over, specified as a symbolic vector. `domain` is a 4-by-1 vector [$xmin$, $xmax$, $ymin$, $ymax$] or a 2-by-1 vector [min , max] (where, $min < x < max$, $min < y < max$). If f is a function of the variables u and v (rather than x and y), then the domain endpoints $umin$, $umax$, $vmin$, and $vmax$ are sorted alphabetically.

n — grid points

number | symbolic number

Grid points, specified as a number or a symbolic number.

See Also

fcontour | fmesh | fplot | fplot3 | fsurf | mesh

Introduced before R2006a

ezmeshc

Combined mesh and contour plotter

Note ezmeshc is not recommended. Use fmesh instead.

Syntax

```
ezmeshc(f)
ezmeshc(f, domain)
ezmeshc(x, y, z)
ezmeshc(x, y, z, domain)
ezmeshc( ____, n)
ezmeshc( ____, 'circ')
```

Description

ezmeshc(f) creates a graph of $f(x,y)$, where f is a symbolic expression that represents a mathematical function of two variables, such as x and y .

The function f is plotted over the default domain $-2\pi < x < 2\pi$, $-2\pi < y < 2\pi$. MATLAB software chooses the computational grid according to the amount of variation that occurs; if the function f is not defined (singular) for points on the grid, then these points are not plotted.

ezmeshc(f, domain) plots f over the specified domain. domain can be either a 4-by-1 vector [$xmin$, $xmax$, $ymin$, $ymax$] or a 2-by-1 vector [min , max] (where, $min < x < max$, $min < y < max$).

If f is a function of the variables u and v (rather than x and y), then the domain endpoints $umin$, $umax$, $vmin$, and $vmax$ are sorted alphabetically. Thus, ezmeshc($u^2 - v^3$, [0, 1], [3, 6]) plots $u^2 - v^3$ over $0 < u < 1$, $3 < v < 6$.

ezmeshc(x, y, z) plots the parametric surface $x = x(s,t)$, $y = y(s,t)$, and $z = z(s,t)$ over the square $-2\pi < s < 2\pi$, $-2\pi < t < 2\pi$.

ezmeshc(x, y, z, domain) plots the parametric surface using the specified domain.

ezmeshc(____, n) plots f over the default domain using an n -by- n grid. The default value for n is 60.

ezmeshc(____, 'circ') plots f over a disk centered on the domain.

Examples

3-D Mesh Plot with Contours

Create a mesh/contour graph of the expression,

$$f(x, y) = \frac{y}{1 + x^2 + y^2},$$

over the domain $-5 < x < 5$, $-2\pi < y < 2\pi$. Use the mouse to rotate the axes to better observe the contour lines (this picture uses a view of azimuth = -65 and elevation = 26).

```
syms x y
ezmeshc(y/(1 + x^2 + y^2), [-5,5, -2*pi,2*pi])
```

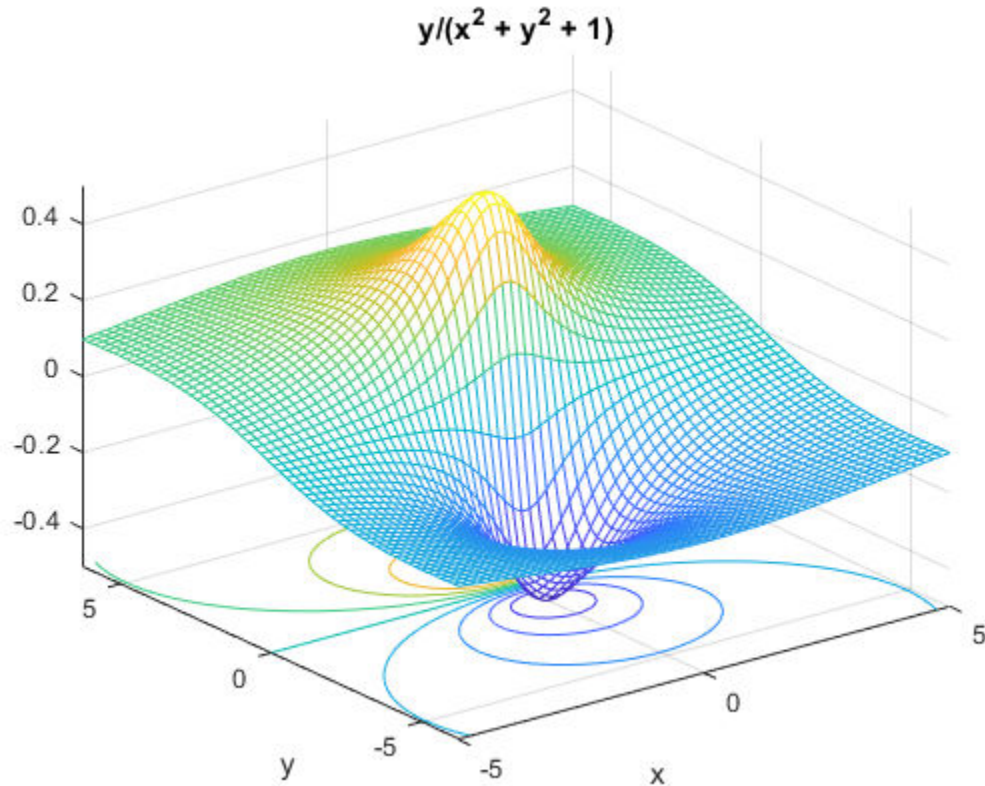

Input Arguments

f – Input

symbolic function | symbolic expression

Input, specified as a symbolic function or expression.

x – Input

symbolic function | symbolic expression

Input, specified as a symbolic function or expression.

y – Input

symbolic function | symbolic expression

Input, specified as a symbolic function or expression.

z – Input

symbolic function | symbolic expression

Input, specified as a symbolic function or expression.

domain — Domain to plot over

symbolic vector

Domain to plot over, specified as a symbolic vector. `domain` is a 4-by-1 vector [$xmin$, $xmax$, $ymin$, $ymax$] or a 2-by-1 vector [min , max] (where, $min < x < max$, $min < y < max$). If f is a function of the variables u and v (rather than x and y), then the domain endpoints $umin$, $umax$, $vmin$, and $vmax$ are sorted alphabetically.

n — grid points

number | symbolic number

Grid points, specified as a number or a symbolic number.

See Also

`fcontour` | `fmesh` | `fplot` | `fplot3` | `fsurf` | `meshc`

Introduced before R2006a

ezplot

Plot symbolic expression, equation, or function

Note ezplot is not recommended. Use fplot instead. For implicit plots, use fimplicit.

Syntax

```
ezplot(f)
ezplot(f,[min,max])
ezplot(f,[xmin,xmax,ymin,ymax])

ezplot(x,y)
ezplot(x,y,[tmin,tmax])

ezplot(f,[min,max],fig)
ezplot(f,[xmin,xmax,ymin,ymax],fig)
ezplot(x,y,[tmin,tmax],fig)

h = ezplot( __ )
```

Description

ezplot(f) plots a symbolic expression, equation, or function f. By default, ezplot plots a univariate expression or function over the range $[-2\pi, 2\pi]$ or over a subinterval of this range. If f is an equation or function of two variables, the default range for both variables is $[-2\pi, 2\pi]$ or over a subinterval of this range.

ezplot(f,[min,max]) plots f over the specified range. If f is a univariate expression or function, then [min,max] specifies the range for that variable. This is the range along the abscissa (horizontal axis). If f is an equation or function of two variables, then [min,max] specifies the range for both variables, that is the ranges along both the abscissa and the ordinate.

ezplot(f,[xmin,xmax,ymin,ymax]) plots f over the specified ranges along the abscissa and the ordinate.

ezplot(x,y) plots the parametrically defined planar curve $x = x(t)$ and $y = y(t)$ over the default range $0 \leq t \leq 2\pi$ or over a subinterval of this range.

ezplot(x,y,[tmin,tmax]) plots $x = x(t)$ and $y = y(t)$ over the specified range $tmin \leq t \leq tmax$.

ezplot(f,[min,max],fig) plots f over the specified range in the figure with the figure number or figure handle fig. The title of each plot window contains the word Figure and the number, for example, **Figure 1**, **Figure 2**, and so on. If fig is already open, ezplot overwrites the content of that figure with the new plot.

ezplot(f,[xmin,xmax,ymin,ymax],fig) plots f over the specified ranges along the abscissa and the ordinate in fig.

ezplot(x,y,[tmin,tmax],fig) plots $x = x(t)$ and $y = y(t)$ over the specified range in fig.

`h = ezplot(___)` returns the plot handle as either a chart line or contour object.

Examples

Plot Over Particular Range

Plot the expression $\text{erf}(x) \cdot \sin(x)$ over the range $[-\pi, \pi]$:

```
syms x
ezplot(erf(x), [-pi, pi])
```

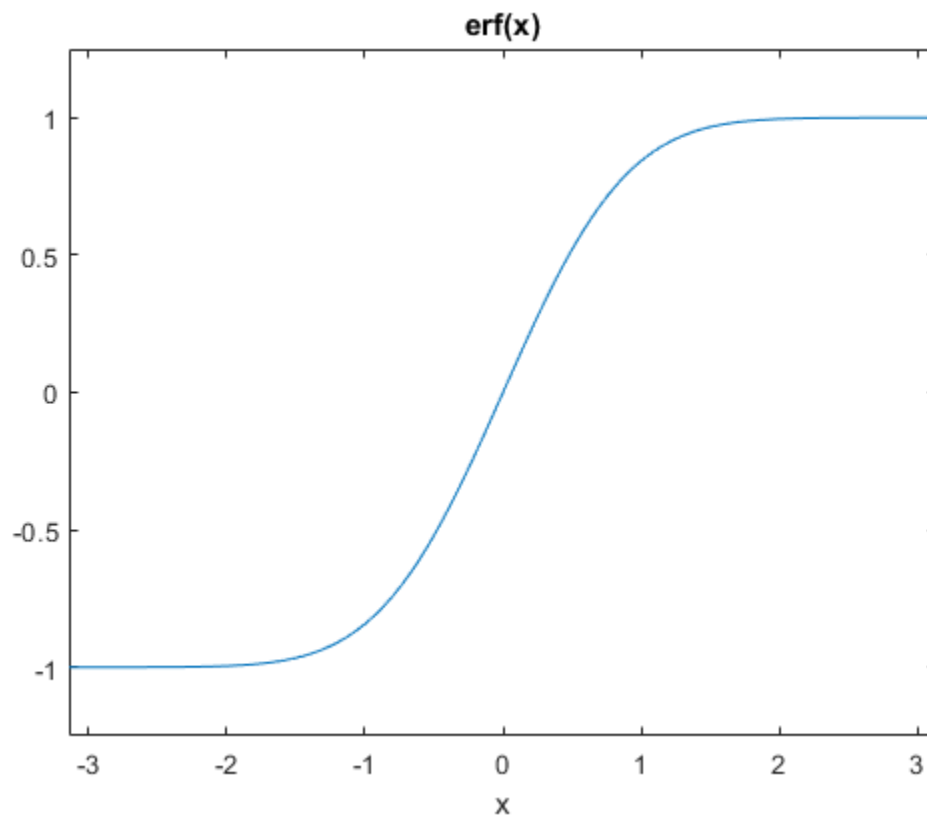

Plot Over Default Range

Plot this equation over the default range.

```
syms x y
ezplot(x^2 == y^4)
```

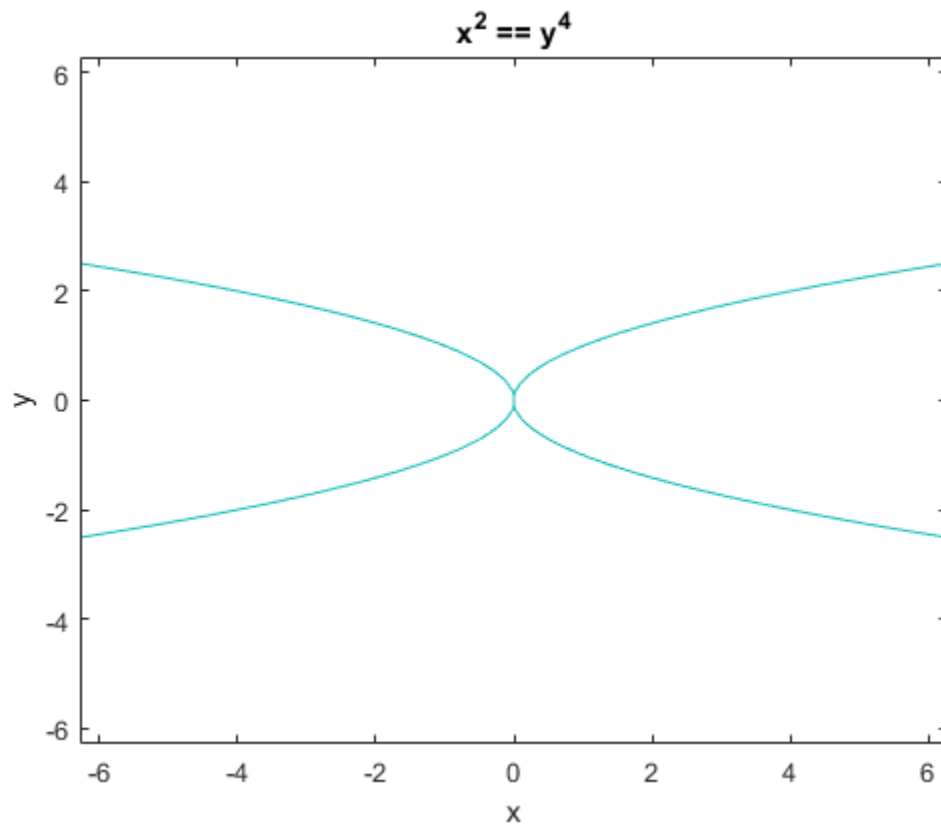

Plot Symbolic Function

Create this symbolic function $f(x, y)$:

```
syms x y  
f(x, y) = sin(x + y)*sin(x*y);
```

Plot this function over the default range:

```
ezplot(f)
```

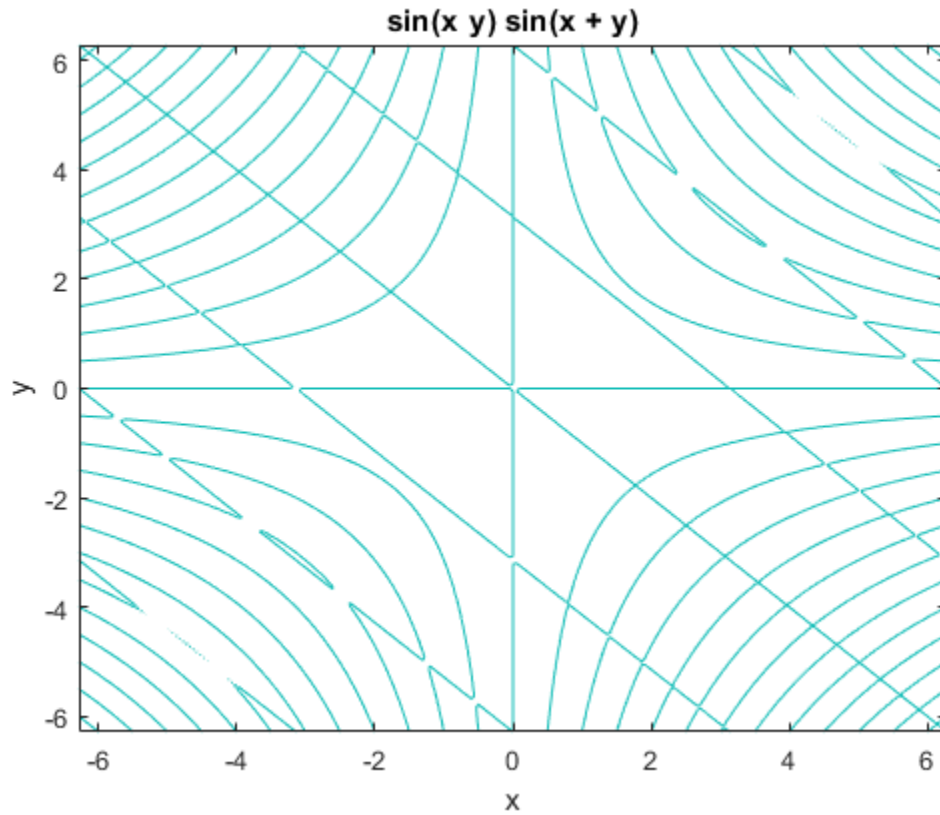

Plot Parametric Curve

Plot this parametric curve:

```
syms t
x = t*sin(5*t);
y = t*cos(5*t);
ezplot(x, y)
```

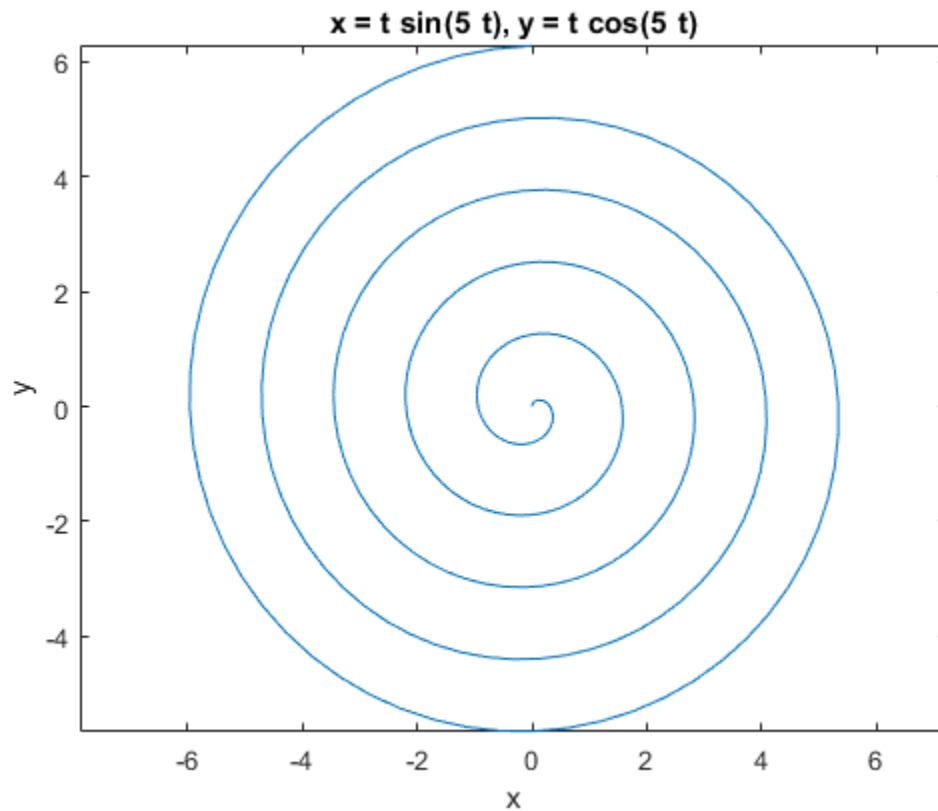

Input Arguments

f – Input

symbolic expression | symbolic equation | symbolic function

Symbolic expression, equation, or function.

[min,max] – Numbers specifying the plotting range

$[-2\pi, 2\pi]$ (default) | vector | symbolic vector

Numbers specifying the plotting range, specified as a vector of length 2. For a univariate expression or function, the plotting range applies to that variable. For an equation or function of two variables, the plotting range applies to both variables. In this case, the range is the same for the abscissa and the ordinate.

[xmin,xmax,ymin,ymax] – Numbers specifying the plotting range

$[-2\pi, 2\pi, -2\pi, 2\pi]$ (default) | vector | symbolic vector

Numbers specifying the plotting range, specified as a numeric or symbolic vector along the abscissa (first two numbers) and the ordinate (last two numbers).

fig – Figure

figure handle | figure window

Figure specified as a figure handle or figure window where you want to display a plot. For figure handle, the current figure handle returned by `gcf`. For figure number, if no plot windows are open,

then 1. If one plot window is open, then the number in the title of that window. If more than one plot window is open, then the highest number in the titles of open windows.

x, y — Parametric curve

symbolic expression | symbolic function

Parametric curve specified as symbolic expressions or functions $x = x(t)$ and $y = y(t)$.

[tmin, tmax] — Plotting range for a parametric curve

[0, 2*pi] (default) | vector | symbolic vector

Plotting range for a parametric curve specified as a numeric or symbolic vector.

Output Arguments

h — Chart line or contour line object

scalar

Chart line or contour line object, returned as a scalar. For details, see [Chart Line and Contour](#).

Tips

- If you do not specify a plot range, `ezplot` uses the interval $[-2\pi, 2\pi]$ as a starting point. Then it can choose to display a part of the plot over a subinterval of $[-2\pi, 2\pi]$ where the plot has significant variation. Also, when selecting the plotting range, `ezplot` omits extreme values associated with singularities.
- `ezplot` opens a plot window and displays a plot there. If any plot windows are already open, `ezplot` does not create a new window. Instead, it displays the new plot in the currently active window. (Typically, it is the window with the highest number.) To display the new plot in a new plot window or in an existing window other than that with the highest number, use `fig`.
- If `f` is an equation or function of two variables, then the alphabetically first variable defines the abscissa (horizontal axis) and the other variable defines the ordinate (vertical axis). Thus, `ezplot(x^2 == a^2, [-3, 3, -2, 2])` creates the plot of the equation $x^2 = a^2$ with $-3 \leq a \leq 3$ along the horizontal axis, and $-2 \leq x \leq 2$ along the vertical axis.

See Also

[fcontour](#) | [fmesh](#) | [fplot](#) | [fplot3](#) | [fsurf](#) | [plot](#)

Topics

“Create Plots” on page 2-229

Introduced before R2006a

ezplot3

3-D parametric curve plotter

Note ezplot3 is not recommended. Use fplot3 instead.

Syntax

```
ezplot3(x,y,z)
ezplot3(x,y,z,[tmin,tmax])
ezplot3(____,'animate')
```

Description

ezplot3(x,y,z) plots the spatial curve $x = x(t)$, $y = y(t)$, and $z = z(t)$ over the default domain $0 < t < 2\pi$.

ezplot3(x,y,z,[tmin,tmax]) plots the curve $x = x(t)$, $y = y(t)$, and $z = z(t)$ over the domain $tmin < t < tmax$.

ezplot3(____,'animate') produces an animated trace of the spatial curve.

Examples

3-D Parametric Curve

Plot the parametric curve $x = \sin(t)$, $y = \cos(t)$, $z = t$ over the domain $[0, 6\pi]$.

```
syms t
ezplot3(sin(t), cos(t), t,[0,6*pi])
```

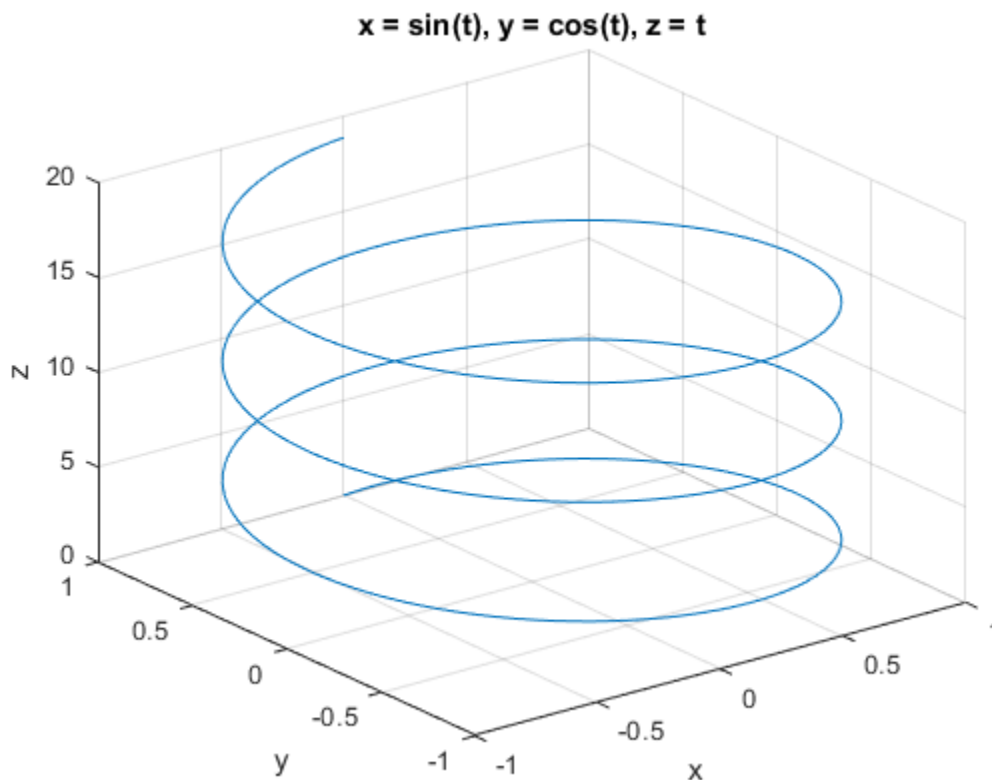

Input Arguments

x – Input

symbolic function | symbolic expression

Input, specified as a symbolic function or expression.

y – Input

symbolic function | symbolic expression

Input, specified as a symbolic function or expression.

z – Input

symbolic function | symbolic expression

Input, specified as a symbolic function or expression.

[tmin, tmax] – Domain to plot over

symbolic vector

Domain to plot over, specified as a symbolic vector. `ezplot3` plots over the domain $tmin < t < tmax$

See Also

`fcontour` | `fmesh` | `fplot` | `fplot3` | `fsurf` | `plot3`

Introduced before R2006a

ezpolar

Polar coordinate plotter

Syntax

```
ezpolar(f)  
ezpolar(f, [a b])
```

Description

`ezpolar(f)` plots the polar curve $r = f(\theta)$ over the default domain $0 < \theta < 2\pi$.

`ezpolar(f, [a b])` plots f for $a < \theta < b$.

Examples

Polar Plot of Symbolic Expression

This example creates a polar plot of the function, $1 + \cos(t)$, over the domain $[0, 2\pi]$.

```
syms t  
ezpolar(1 + cos(t))
```

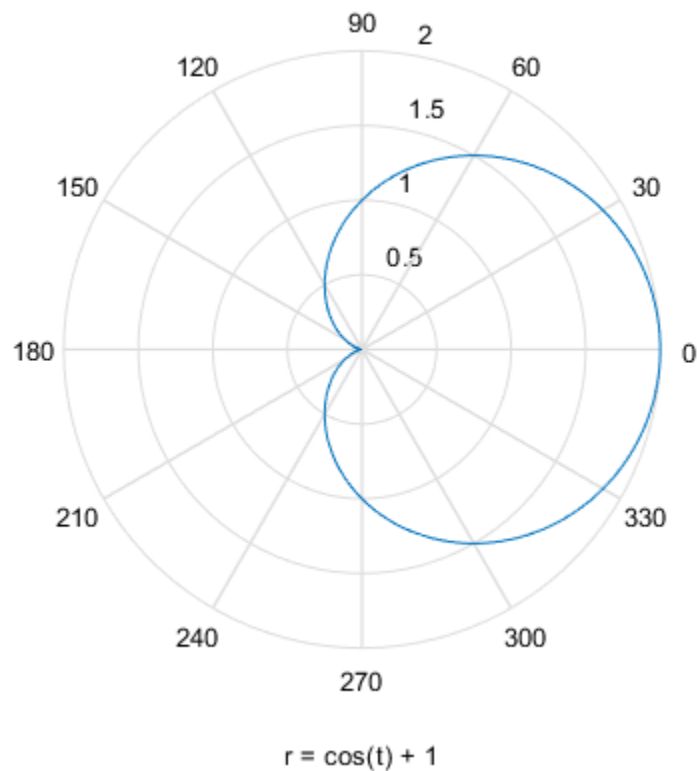

Input Arguments

f — Input

symbolic function | symbolic expression

Input, specified as a symbolic function or expression.

[a b] — Angle to plot over

vector | symbolic vector

Angle to plot over, specified as a vector, or a symbolic vector.

Introduced before R2006a

ezsurf

Plot 3-D surface

Note ezsurf is not recommended. Use fsurf instead.

Syntax

```
ezsurf(f)
ezsurf(f,[xmin,xmax])
ezsurf(f,[xmin,xmax,ymin,ymax])

ezsurf(x,y,z)
ezsurf(x,y,z,[smin,smax])
ezsurf(x,y,z,[smin,smax,tmin,tmax])

ezsurf( ____,n)
ezsurf( ____, 'circ')

h = ezsurf( ____ )
```

Description

ezsurf(f) plots a two-variable symbolic expression or function $f(x,y)$ over the range $-2\pi < x < 2\pi$, $-2\pi < y < 2\pi$.

ezsurf(f,[xmin,xmax]) plots $f(x,y)$ over the specified range $x_{\min} < x < x_{\max}$. This is the range along the abscissa (horizontal axis).

ezsurf(f,[xmin,xmax,ymin,ymax]) plots $f(x,y)$ over the specified ranges along the abscissa, $x_{\min} < x < x_{\max}$, and the ordinate, $y_{\min} < y < y_{\max}$.

When determining the range values, ezsurf sorts variables alphabetically. For example, ezsurf($x^2 - a^3$, [0,1,3,6]) plots $x^2 - a^3$ over $0 < a < 1$, $3 < x < 6$.

ezsurf(x,y,z) plots the parametric surface $x = x(s,t)$, $y = y(s,t)$, $z = z(s,t)$ over the range $-2\pi < s < 2\pi$, $-2\pi < t < 2\pi$.

ezsurf(x,y,z,[smin,smax]) plots the parametric surface $x = x(s,t)$, $y = y(s,t)$, $z = z(s,t)$ over the specified range $s_{\min} < s < s_{\max}$.

ezsurf(x,y,z,[smin,smax,tmin,tmax]) plots the parametric surface $x = x(s,t)$, $y = y(s,t)$, $z = z(s,t)$ over the specified ranges $s_{\min} < s < s_{\max}$ and $t_{\min} < t < t_{\max}$.

ezsurf(____, n) specifies the grid. You can specify n after the input arguments in any of the previous syntaxes. By default, $n = 60$.

ezsurf(____, 'circ') creates the surface plot over a disk centered on the range. You can specify 'circ' after the input arguments in any of the previous syntaxes.

`h = ezsurf(___)` returns a handle `h` to the surface plot object. You can use the output argument `h` with any of the previous syntaxes.

Examples

Plot Function Over Default Range

Plot the symbolic function $f(x,y) = \text{real}(\text{atan}(x + i*y))$ over the default range $-2*\pi < x < 2*\pi$, $-2*\pi < y < 2*\pi$.

Create the symbolic function.

```
syms f(x,y)
f(x,y) = real(atan(x + i*y));
```

Plot this function using `ezsurf`.

```
ezsurf(f)
```

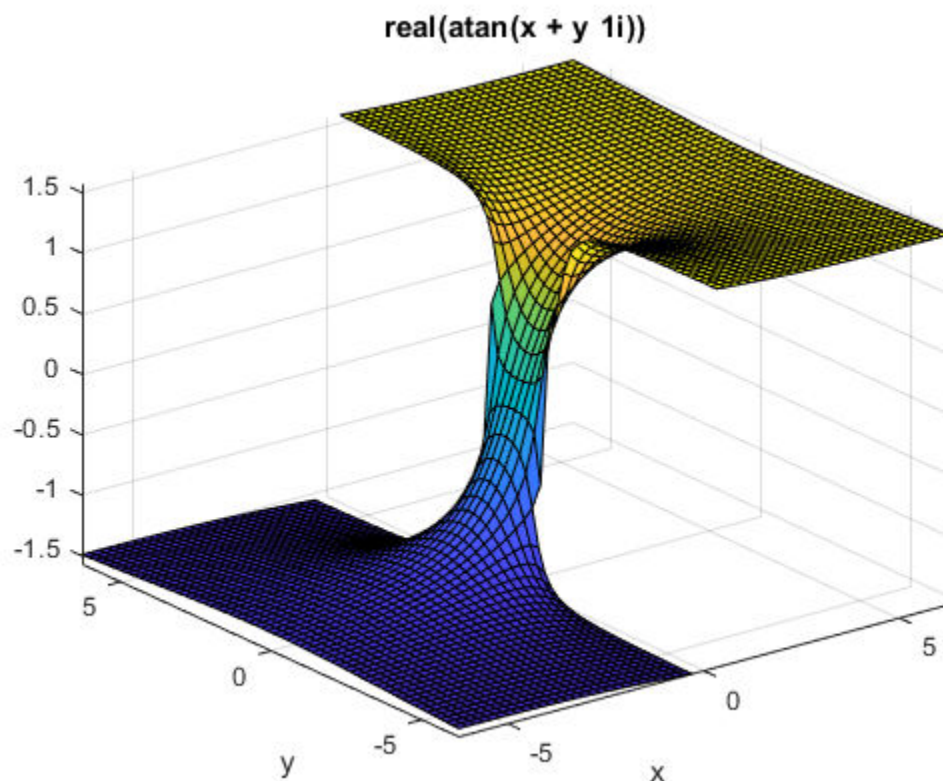

Specify Plotting Ranges

Plot the symbolic expression $x^2 + y^2$ over the range $-1 < x < 1$. Because you do not specify the range for the `y`-axis, `ezsurf` chooses it automatically.

```
syms x y  
ezsurf(x^2 + y^2, [-1, 1])
```

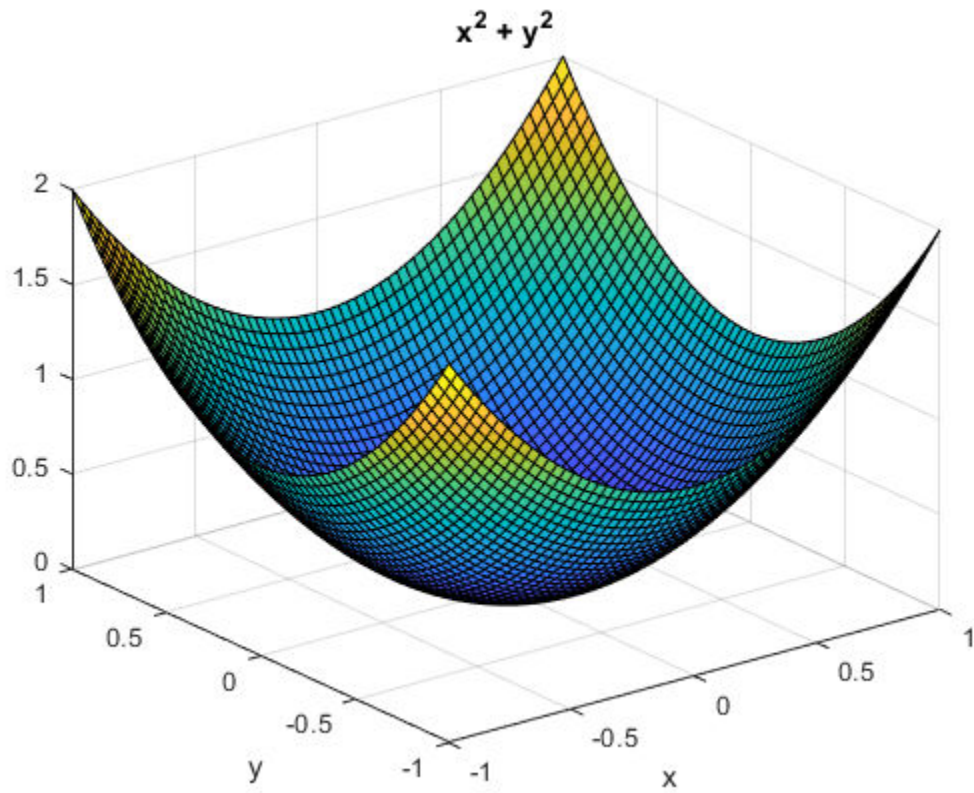

Specify the range for both axes.

```
ezsurf(x^2 + y^2, [-1, 1, -0.5, 1.5])
```

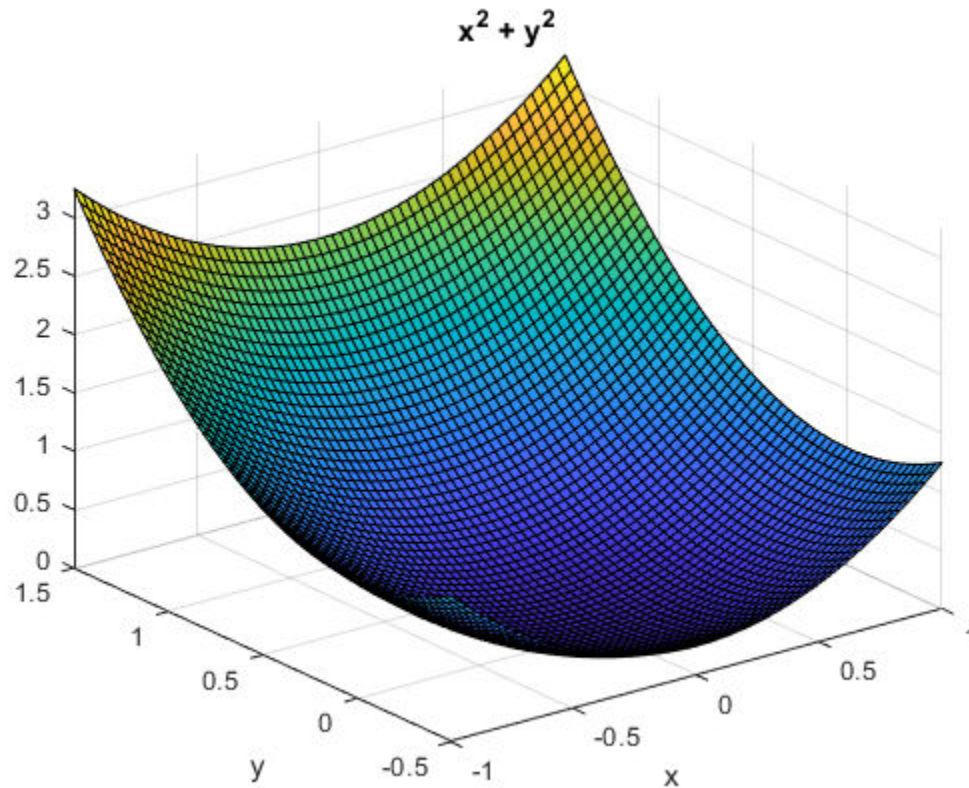
Plot Parameterized Surface

Define the parametric surface $x(s, t)$, $y(s, t)$, $z(s, t)$ as follows.

```
syms s t
r = 2 + sin(7*s + 5*t);
x = r*cos(s)*sin(t);
y = r*sin(s)*sin(t);
z = r*cos(t);
```

Plot the function using ezsurf.

```
ezsurf(x, y, z, [0, 2*pi, 0, pi])
title('Parametric surface')
```

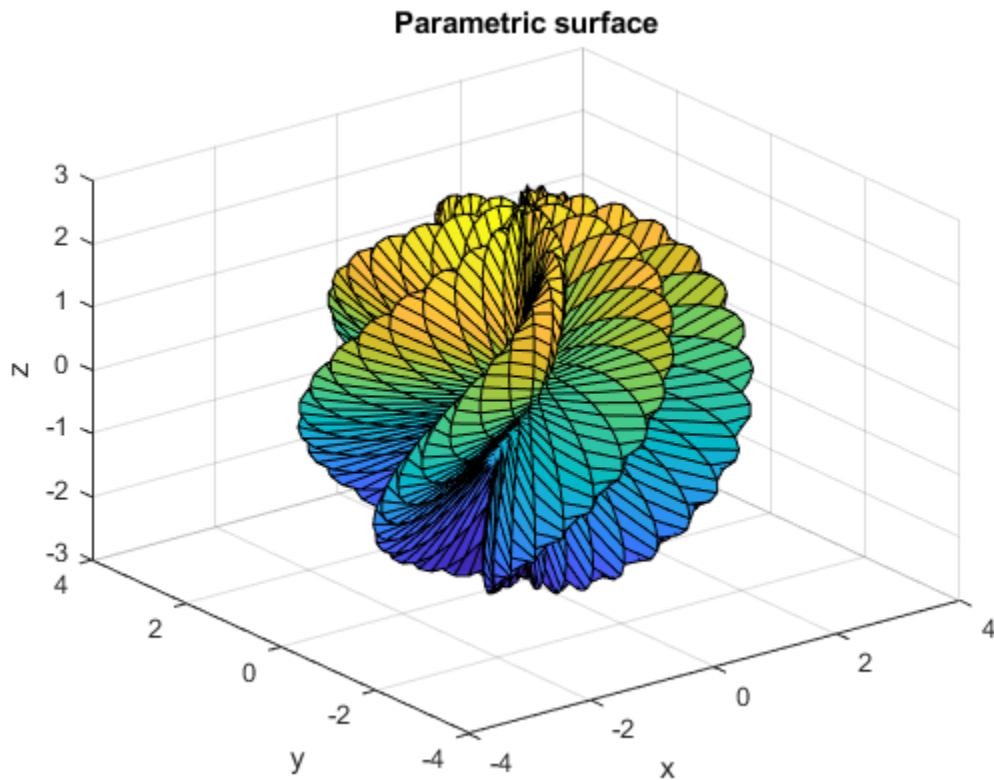

To create a smoother plot, increase the number of mesh points.

```
ezsurf(x, y, z, [0, 2*pi, 0, pi], 120)  
title('Parametric surface with grid = 120')
```

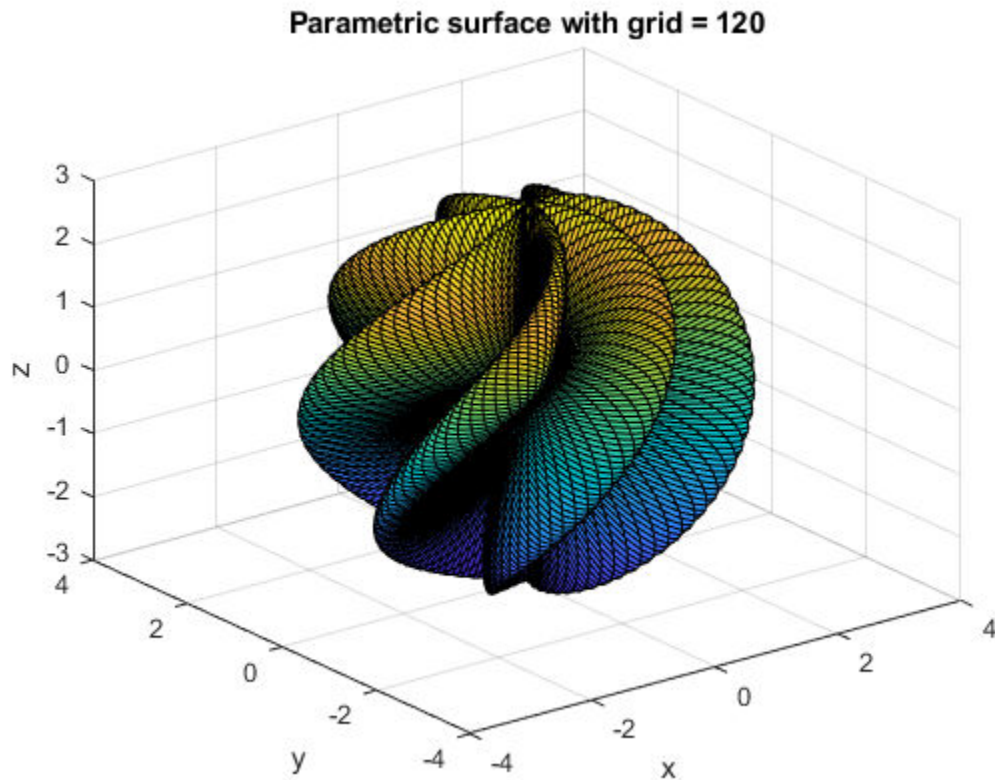

Specify Disk Plotting Range

First, plot the expression $\sin(x^2 + y^2)$ over the square range $-\pi/2 < x < \pi/2$, $-\pi/2 < y < \pi/2$.

```
syms x y
ezsurf(sin(x^2 + y^2), [-pi/2, pi/2, -pi/2, pi/2])
```

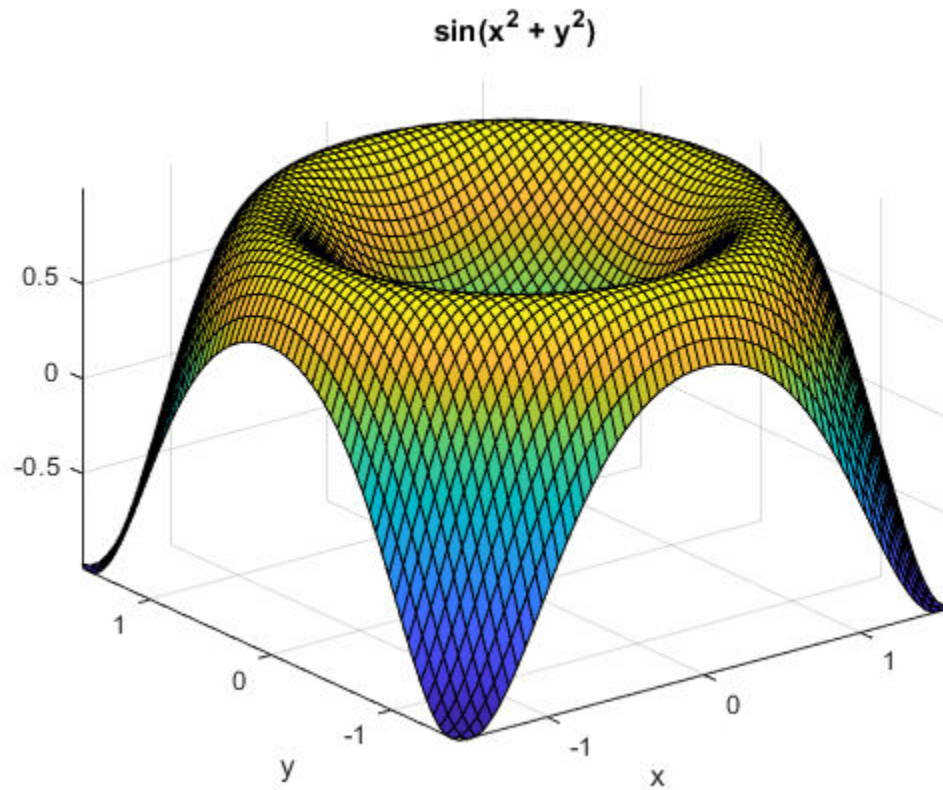

Now, plot the same expression over the disk range.

```
ezsurf(sin(x^2 + y^2), [-pi/2, pi/2, -pi/2, pi/2], 'circ')
```

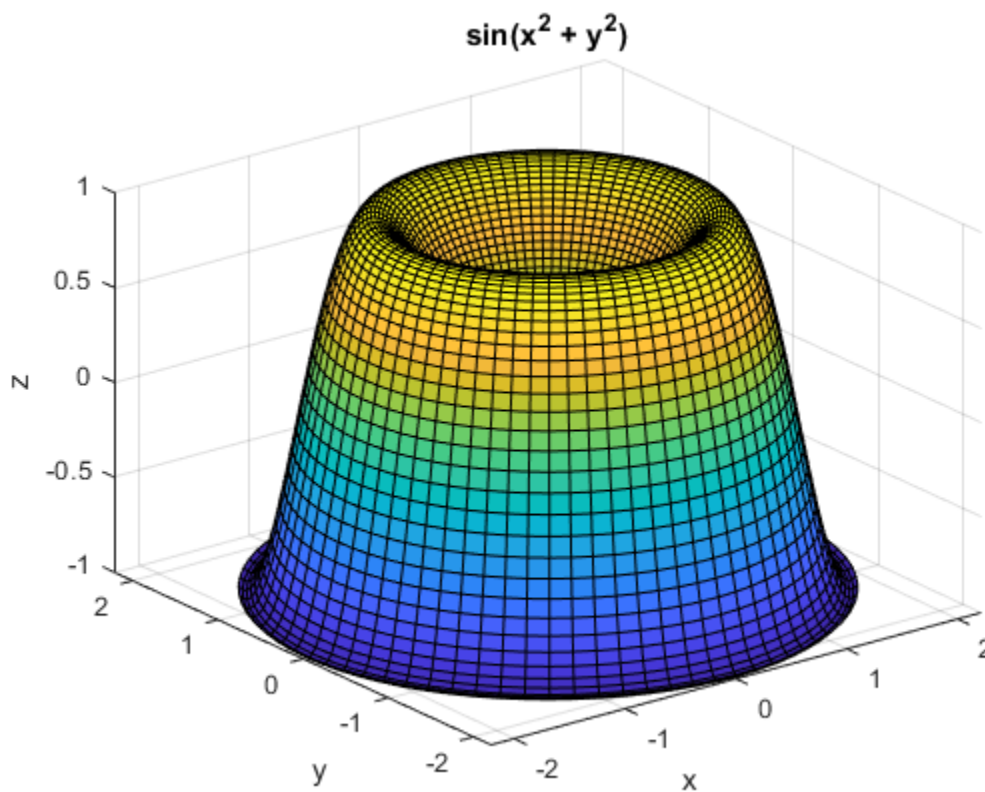

Use Handle to Surface Plot

Plot the symbolic expression $\sin(x)\cos(y)$, and assign the result to the handle h .

```
syms x y  
h = ezsurf(sin(x)*cos(y), [-pi, pi])
```

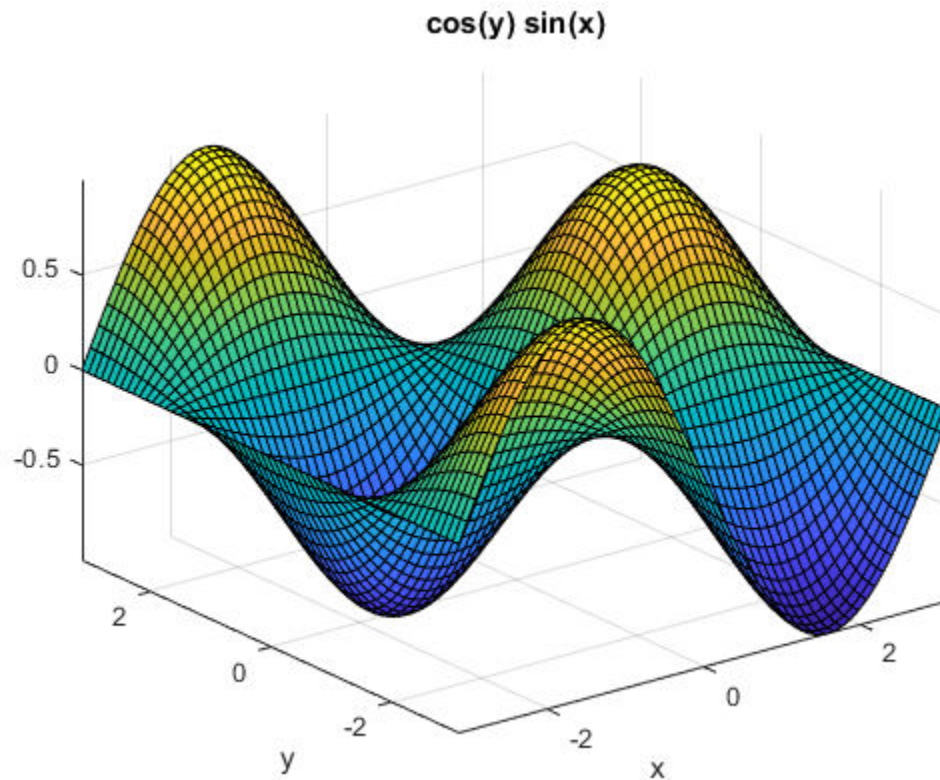

```
h =  
Surface with properties:  
  
EdgeColor: [0 0 0]  
LineStyle: '-'  
FaceColor: 'flat'  
FaceLighting: 'flat'  
FaceAlpha: 1  
XData: [60x60 double]  
YData: [60x60 double]  
ZData: [60x60 double]  
CData: [60x60 double]
```

Show all properties

You can use this handle to change properties of the plot. For example, change the color of the area outline.

```
h.EdgeColor = 'red'
```

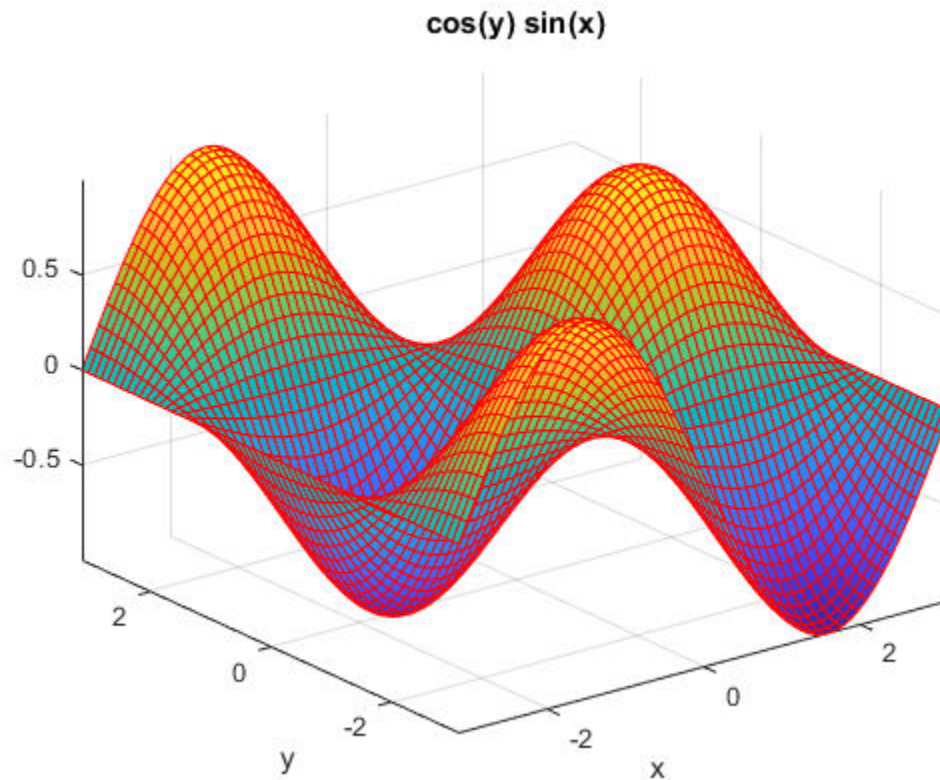

```
h =
  Surface with properties:
    EdgeColor: [1 0 0]
    LineStyle: '-'
    FaceColor: 'flat'
    FaceLighting: 'flat'
    FaceAlpha: 1
    XData: [60x60 double]
    YData: [60x60 double]
    ZData: [60x60 double]
    CData: [60x60 double]
```

Show all properties

Input Arguments

f — Function to plot

symbolic expression with two variables | symbolic function of two variables

Function to plot, specified as a symbolic expression or function of two variables.

Example: `ezsurf(x^2 + y^2)`

x, y, z — Parametric function to plot

three symbolic expressions with two variables | three symbolic functions of two variables

Parametric function to plot, specified as three symbolic expressions or functions of two variables.

Example: `ezsurf(s*cos(t), s*sin(t), t)`

n — Grid value

integer

Grid value, specified as an integer. The default grid value is 60.

Output Arguments**h — Surface plot handle**

scalar

Surface plot handle, returned as a scalar. It is a unique identifier, which you can use to query and modify properties of the surface plot.

Tips

- `ezsurf` chooses the computational grid according to the amount of variation that occurs. If `f` is singular for some points on the grid, then `ezsurf` omits these points. The value at these points is set to NaN.

See Also

`fcontour` | `fmesh` | `fplot` | `fplot3` | `fsurf` | `surf`

Topics

“Create Plots” on page 2-229

Introduced before R2006a

ezsurf

Combined surface and contour plotter

Note ezsurf is not recommended. Use fsurf instead.

Syntax

```
ezsurf(f)
ezsurf(f, domain)
ezsurf(x, y, z)
ezsurf(x, y, z, domain)
ezsurf( ___, n)
ezsurf( ___, 'circ')
```

Description

`ezsurf(f)` creates a graph of $f(x,y)$, where f is a symbolic expression that represents a mathematical function of two variables, such as x and y . The function f is plotted over the default domain $-2\pi < x < 2\pi$, $-2\pi < y < 2\pi$. MATLAB software chooses the computational grid according to the amount of variation that occurs; if the function f is not defined (singular) for points on the grid, then these points are not plotted.

`ezsurf(f, domain)` plots f over the specified domain. `domain` can be either a 4-by-1 vector $[xmin, xmax, ymin, ymax]$ or a 2-by-1 vector $[min, max]$ (where, $min < x < max$, $min < y < max$).

If f is a function of the variables u and v (rather than x and y), then the domain endpoints $umin$, $umax$, $vmin$, and $vmax$ are sorted alphabetically. Thus, `ezsurf(u^2 - v^3, [0, 1], [3, 6])` plots $u^2 - v^3$ over $0 < u < 1$, $3 < v < 6$.

`ezsurf(x, y, z)` plots the parametric surface $x = x(s,t)$, $y = y(s,t)$, and $z = z(s,t)$ over the square $-2\pi < s < 2\pi$, $-2\pi < t < 2\pi$.

`ezsurf(x, y, z, domain)` plots the parametric surface using the specified domain.

`ezsurf(___, n)` plots f over the default domain using an n -by- n grid. The default value for n is 60.

`ezsurf(___, 'circ')` plots f over a disk centered on the domain.

Examples

3-D Surface Plot with Contours

Create a surface/contour plot of the expression,

$$f(x, y) = \frac{y}{1 + x^2 + y^2},$$

over the domain $-5 < x < 5$, $-2\pi < y < 2\pi$, with a computational grid of size 35-by-35. Use the mouse to rotate the axes to better observe the contour lines (this picture uses a view of azimuth = -65 and elevation = 26).

```
syms x y  
ezsurf(y/(1 + x^2 + y^2), [-5,5, -2*pi,2*pi], 35)
```

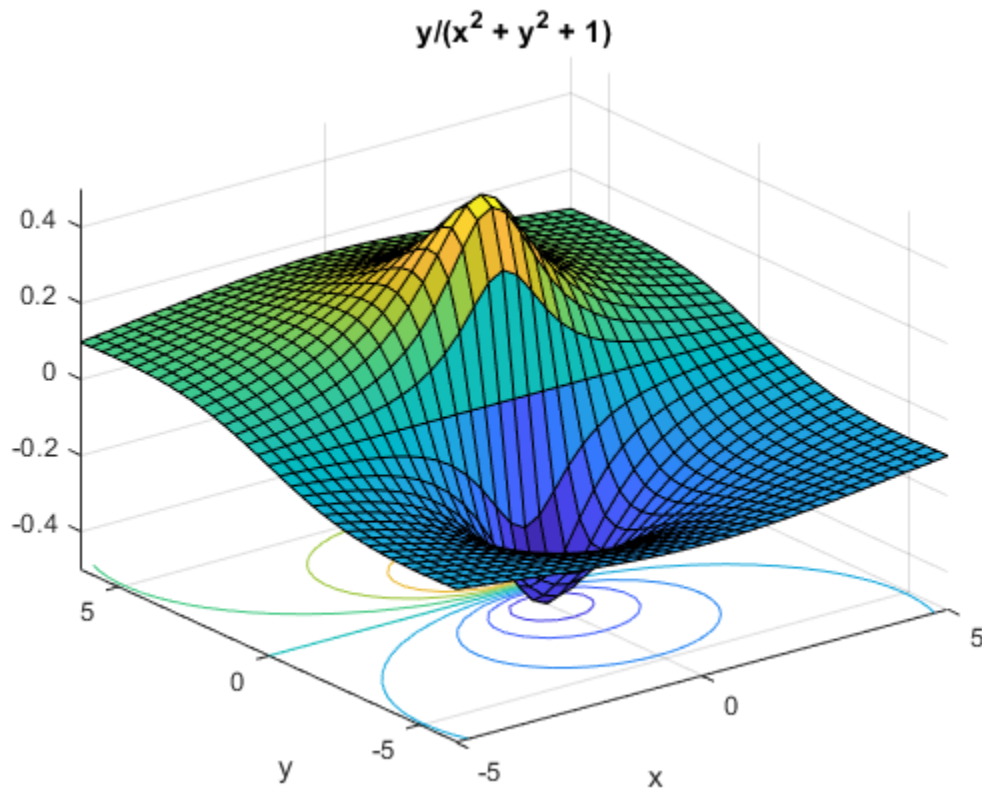

Input Arguments

f – Input

symbolic function | symbolic expression

Input, specified as a symbolic function or expression.

x – Input

symbolic function | symbolic expression

Input, specified as a symbolic function or expression.

y – Input

symbolic function | symbolic expression

Input, specified as a symbolic function or expression.

z – Input

symbolic function | symbolic expression

Input, specified as a symbolic function or expression.

domain — Domain to plot over

symbolic vector

Domain to plot over, specified as a symbolic vector. `domain` is a 4-by-1 vector [$xmin$, $xmax$, $ymin$, $ymax$] or a 2-by-1 vector [min , max] (where, $min < x < max$, $min < y < max$). If f is a function of the variables u and v (rather than x and y), then the domain endpoints $umin$, $umax$, $vmin$, and $vmax$ are sorted alphabetically.

n — grid points

number | symbolic number

Grid points, specified as a number or a symbolic number.

See Also

`fcontour` | `fmesh` | `fplot` | `fplot3` | `fsurf` | `surf`

Introduced before R2006a

factor

Factorization

Syntax

```
F = factor(x)
F = factor(x,vars)
F = factor( ____,Name,Value)
```

Description

`F = factor(x)` returns all irreducible factors of `x` in vector `F`. If `x` is an integer, `factor` returns the prime factorization of `x`. If `x` is a symbolic expression, `factor` returns the subexpressions that are factors of `x`.

`F = factor(x,vars)` returns an array of factors `F`, where `vars` specifies the variables of interest. All factors not containing a variable in `vars` are separated into the first entry `F(1)`. The other entries are irreducible factors of `x` that contain one or more variables from `vars`.

`F = factor(____,Name,Value)` uses additional options specified by one or more `Name,Value` pair arguments. This syntax can use any of the input arguments from the previous syntaxes.

Examples

Factor Integer Numbers

```
F = factor(823429252)
F =
     2           2           59           283           12329
```

To factor integers greater than `flintmax`, convert the integer to a symbolic object using `sym`. Then place the number in quotation marks to represent it accurately.

```
F = factor(sym('82342925225632328'))
F =
[ 2, 2, 2, 251, 401, 18311, 5584781]
```

To factor a negative integer, convert it to a symbolic object using `sym`.

```
F = factor(sym(-92465))
F =
[ -1, 5, 18493]
```

Perform Prime Factorization of Large Numbers

Perform prime factorization for 41758540882408627201. Since the integer is greater than `flintmax`, convert it to a symbolic object using `sym`, and place the number in quotation marks to represent it accurately.

```
n = sym('41758540882408627201');
factor(n)
```

```
ans =
 [ 479001599, 87178291199]
```

Factor Symbolic Fractions

Factor the fraction $112/81$ by converting it into a symbolic object using `sym`.

```
F = factor(sym(112/81))
```

```
F =
 [ 2, 2, 2, 2, 7, 1/3, 1/3, 1/3, 1/3]
```

Factor Polynomials

Factor the polynomial $x^6 - 1$.

```
syms x
F = factor(x^6-1)
```

```
F =
 [ x - 1, x + 1, x^2 + x + 1, x^2 - x + 1]
```

Factor the polynomial $y^6 - x^6$.

```
syms y
F = factor(y^6-x^6)
```

```
F =
 [ -1, x - y, x + y, x^2 + x*y + y^2, x^2 - x*y + y^2]
```

Separate Factors Containing Specified Variables

Factor y^2*x^2 for factors containing x .

```
syms x y
F = factor(y^2*x^2,x)
```

```
F =
 [ y^2, x, x]
```

`factor` combines all factors without x into the first element. The remaining elements of F contain irreducible factors that contain x .

Factor the polynomial y for factors containing symbolic variables b and c .

```
syms a b c d
y = -a*b^5*c*d*(a^2 - 1)*(a*d - b*c);
F = factor(y,[b c])
```

```
F =
 [ -a*d*(a - 1)*(a + 1), b, b, b, b, b, c, a*d - b*c]
```

`factor` combines all factors without b or c into the first element of F . The remaining elements of F contain irreducible factors of y that contain either b or c .

Choose Factorization Modes

Use the `FactorMode` argument to choose a particular factorization mode.

Factor an expression without specifying the factorization mode. By default, `factor` uses factorization over rational numbers. In this mode, `factor` keeps rational numbers in their exact symbolic form.

```
syms x
factor(x^3 + 2, x)
```

```
ans =
x^3 + 2
```

Factor the same expression, but this time use numeric factorization over real numbers. This mode factors the expression into linear and quadratic irreducible polynomials with real coefficients and converts all numeric values to floating-point numbers.

```
factor(x^3 + 2, x, 'FactorMode', 'real')
```

```
ans =
[ x + 1.2599210498948731647672106072782, ...
  x^2 - 1.2599210498948731647672106072782*x + 1.5874010519681994747517056392723]
```

Factor this expression using factorization over complex numbers. In this mode, `factor` reduces quadratic polynomials to linear expressions with complex coefficients. This mode converts all numeric values to floating-point numbers.

```
factor(x^3 + 2, x, 'FactorMode', 'complex')
```

```
ans =
[ x + 1.2599210498948731647672106072782, ...
  x - 0.62996052494743658238360530363911 + 1.0911236359717214035600726141898i, ...
  x - 0.62996052494743658238360530363911 - 1.0911236359717214035600726141898i]
```

Factor this expression using the full factorization mode. This mode factors the expression into linear expressions, reducing quadratic polynomials to linear expressions with complex coefficients. This mode keeps rational numbers in their exact symbolic form.

```
factor(x^3 + 2, x, 'FactorMode', 'full')
```

```
ans =
[ x + 2^(1/3), ...
  x - 2^(1/3)*((3^(1/2)*1i)/2 + 1/2), ...
  x + 2^(1/3)*((3^(1/2)*1i)/2 - 1/2)]
```

Approximate the result with floating-point numbers by using `vpa`. Because the expression does not contain any symbolic parameters besides the variable `x`, the result is the same as in complex factorization mode.

```
vpa(ans)
```

```
ans =
[ x + 1.2599210498948731647672106072782, ...
  x - 0.62996052494743658238360530363911 - 1.0911236359717214035600726141898i, ...
  x - 0.62996052494743658238360530363911 + 1.0911236359717214035600726141898i]
```

Approximate Results Containing RootOf

In the full factorization mode, `factor` also can return results as a symbolic sums over polynomial roots expressed as `RootOf`.

Factor this expression.

```
syms x
s = factor(x^3 + x - 3, x, 'FactorMode','full')

s =
[ x - root(z^3 + z - 3, z, 1),...
  x - root(z^3 + z - 3, z, 2),...
  x - root(z^3 + z - 3, z, 3)]
```

Approximate the result with floating-point numbers by using `vpa`.

```
vpa(s)

ans =
[ x - 1.2134116627622296341321313773815,...
  x + 0.60670583138111481706606568869074 + 1.450612249188441526515442203395i,...
  x + 0.60670583138111481706606568869074 - 1.450612249188441526515442203395i]
```

Input Arguments

x — Input to factor

number | symbolic number | symbolic expression | symbolic function

Input to factor, specified as a number, or a symbolic number, expression, or function.

vars — Variables of interest

symbolic variable | vector of symbolic variables

Variables of interest, specified as a symbolic variable or a vector of symbolic variables. Factors that do not contain a variable specified in `vars` are grouped into the first element of `F`. The remaining elements of `F` contain irreducible factors of `x` that contain a variable in `vars`.

Name-Value Pair Arguments

Specify optional comma-separated pairs of `Name`, `Value` arguments. `Name` is the argument name and `Value` is the corresponding value. `Name` must appear inside quotes. You can specify several name and value pair arguments in any order as `Name1, Value1, ..., NameN, ValueN`.

Example: `factor(x^3 - 2, x, 'FactorMode', 'real')`

FactorMode — Factorization mode

'rational' (default) | 'real' | 'complex' | 'full'

Factorization mode, specified as the comma-separated pair consisting of 'FactorMode' and one of these character vectors.

'rational'	Factorization over rational numbers.
------------	--------------------------------------

'real'	Factorization over real numbers. A real numeric factorization is a factorization into linear and quadratic irreducible polynomials with real coefficients. This factorization mode requires the coefficients of the input to be convertible to real floating-point numbers. All other inputs (for example, those inputs containing symbolic or complex coefficients) are treated as irreducible.
'complex'	Factorization over complex numbers. A complex numeric factorization is a factorization into linear factors whose coefficients are floating-point numbers. Such factorization is only available if the coefficients of the input are convertible to floating-point numbers, that is, if the roots can be determined numerically. Symbolic inputs are treated as irreducible.
'full'	Full factorization. A full factorization is a symbolic factorization into linear factors. The result shows these factors using radicals or as a <code>symsum</code> ranging over a <code>RootOf</code> .

Output Arguments

F — Factors of input

symbolic vector

Factors of input, returned as a symbolic vector.

Tips

- To factor an integer greater than `flintmax`, wrap the integer with `sym`. Then place the integer in quotation marks to represent it accurately, for example, `sym('465971235659856452')`.
- To factor a negative integer, wrap the integer with `sym`, for example, `sym(-3)`.

See Also

`collect` | `combine` | `divisors` | `expand` | `horner` | `numden` | `rewrite` | `simplify` | `simplifyFraction`

Topics

"Choose Function to Rearrange Expression" on page 2-104

Introduced before R2006a

factorial

Factorial of symbolic input

Syntax

```
f = factorial(n)
```

Description

`f = factorial(n)` returns the factorial on page 4-445 of `n`. If `n` is an array, `factorial` acts element-wise on `n`.

Examples

Factorial for Symbolic Number

Compute the factorial for a symbolic number.

```
f = factorial(sym(20))
f = 2432902008176640000
```

Compute Factorial Function for Symbolic Expression

Compute the factorial function for a symbolic expression. `factorial` returns exact symbolic output as the function call.

```
syms n
expr = n^2 + 1;
f = factorial(expr)
```

$$f = (n^2 + 1)!$$

Calculate the factorial for a value of `n = 3`. Substitute the value of `n` by using `subs`.

```
fVal = subs(f,n,3)
fVal = 3628800
```

Differentiate Factorial Function

Differentiate an expression containing the factorial function $(n^2 + n + 1)!$

```
syms n
f = factorial(n^2 + n + 1)
```

$$f = (n^2 + n + 1)!$$

$$df = \text{diff}(f)$$

$$df = (n^2 + n + 1)! \psi(n^2 + n + 2) (2n + 1)$$

The derivative of the factorial function is expressed in terms of the `psi` function.

Expand Factorial Function

Expand an expression containing the factorial function.

```
syms n
f = factorial(n^2 + n + 1);
f1 = expand(f)
```

$$f1 = (n^2 + n)! (n^2 + n + 1)$$

Limit of Factorial Function

Compute the limit at infinity for an expression containing the factorial function.

```
syms n
f = factorial(n)/exp(n);
fLim = limit(f,n,Inf)
```

$$fLim = \infty$$

Compute Factorial for Array Input

Compute factorial for array input. `factorial` acts element-wise on array input.

```
A = sym([1 3; 4 5]);
f = factorial(A)
```

$$f = \begin{pmatrix} 1 & 6 \\ 24 & 120 \end{pmatrix}$$

Input Arguments

n – Input

number | vector | matrix | array | symbolic number | symbolic variable | symbolic array | symbolic function | symbolic expression

Input, specified as a number, vector, matrix, or array, or a symbolic number, variable, array, function, or expression.

More About

Factorial Function

The factorial of a number n is defined as follows.

$$n! = \prod_{k=1}^n k$$

The factorial of 0 is 1.

Tips

- Calling `factorial` for a number that is not a symbolic object invokes the MATLAB `factorial` function.

See Also

[beta](#) | [gamma](#) | [nchoosek](#) | [psi](#)

Introduced in R2012a

factorIntegerPower

Perfect power factoring

Syntax

```
x = factorIntegerPower(n)
[x,k] = factorIntegerPower(n)
```

Description

`x = factorIntegerPower(n)` factors the number n into its perfect power x^k and returns the base x . If several perfect powers exist, x is returned for maximum k . The function `factorIntegerPower` acts element-wise on array input.

`[x,k] = factorIntegerPower(n)` returns both the base x and power k .

Examples

Factor Integer into Perfect Power

Factor 64 into its perfect power. If several perfect powers exist for a number, the maximum k is returned.

```
n = 64;
[x,k] = factorIntegerPower(n)
```

```
x =
    2
k =
    6
```

Find perfect powers of 7, 841, and 2541865828329.

```
n = [7 841 2541865828329];
[x,k] = factorIntegerPower(n)
```

```
x =
    7    29    3
k =
    1    2   26
```

Reconstruct the numbers. Return exact symbolic integers instead of floating point by converting x to symbolic form.

```
sym(x).^k
```

```
ans =
 [ 7, 841, 2541865828329]
```

Test if Number Is Perfect Power

If a number is not a perfect power, `factorIntegerPower` returns the number itself as the base with exponent 1. So, a number is a perfect power if it does not equal its base.

Check if 125 is a perfect power. `isequal` returns logical 0 (false), meaning 125 is not equal to the returned base. Therefore, 125 is a perfect power.

```
n = 125;  
isequal(n, factorIntegerPower(n))
```

```
ans =  
    logical  
     0
```

Input Arguments

n — Input

number | vector | matrix | array | symbolic number | symbolic array

Input, specified as a number, vector, matrix, array, or a symbolic number or array. n must be a positive integer.

Output Arguments

x — Base in perfect power

number | vector | matrix | array | symbolic number | symbolic array

Base in perfect power, returned as a number, vector, matrix, array, or a symbolic number or array.

k — Power in perfect power

number | vector | matrix | array | symbolic number | symbolic array

Power in perfect power, returned as a number, vector, matrix, array, or a symbolic number or array.

See Also

`factor`

Introduced in R2018a

fanimator

Create stop-motion animation object

Syntax

```
fanimator(f)
fanimator(f, args)

fanimator( ____, Name, Value)
fanimator(ax, ____)
fp = fanimator( ____)
```

Description

`fanimator(f)` creates a stop-motion animation object from the function `f`. The function `f` must return graphics objects that depend on only one variable. This variable defines the time parameter of the animation.

By default, `fanimator` creates stop-motion frames of $f(t_0)$, generating 10 frames per unit interval of t_0 within the range of t_0 from 0 to 10.

`fanimator(f, args)` allows the function `f` to depend on multiple variables. `args` specifies the input arguments of `f`.

By default, the variable `t = sym('t')` is the time parameter of the animation. This syntax creates stop-motion frames of $f(\text{subs}(\text{args}, t, t_0))$ within the range of t_0 from 0 to 10. You can animate a specific property of the graphics objects by setting its value to depend on `t` in the input argument `args`.

`fanimator(____, Name, Value)` specifies the animation properties using one or more `Name, Value` pair arguments. Use this option with any of the input argument combinations in the previous syntaxes. Name-value pair settings apply to the animation object created.

`fanimator(ax, ____)` creates a stop-motion animation object in the axis specified by `ax` instead of in the current axis (`gca`). The option `ax` can precede any input argument combinations in the previous syntaxes.

`fp = fanimator(____)` returns an `Animator` object. Use `fp` to query and modify the properties of a specific animation object. For a list of properties, see `Animator Properties`.

Examples

Create Animation of Moving Point and Circle

Animate a point and a circle that move along a straight line.

First, create a function to plot a point at $(t, 1)$. The variable `t` defines the time parameter of the animation.

```
f = @(t) plot(t,1,'r*');
```

Create a stop-motion animation object defined by f.

```
fanimator(f)
```

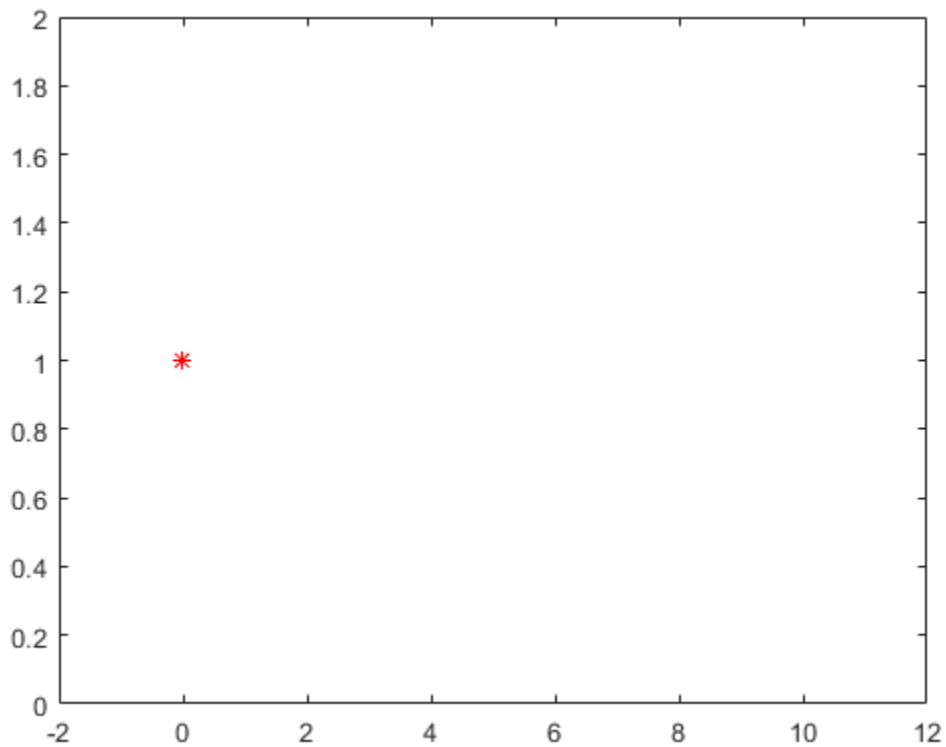

Next, create a function handle by using `fplot` to plot a unit circle. The circle is a function of two variables.

Create two symbolic variables `t` and `x`. Use `t` to set the center of the circle at $(t, 1)$ and `x` to parameterize the perimeter of the circle within the range $[-\pi, \pi]$. Add the circle animation object to the existing plot. Set the x-axis and y-axis to be equal length.

```
syms t x
hold on
fanimator(@fplot,cos(x)+t,sin(x)+1,[-pi pi])
axis equal
hold off
```

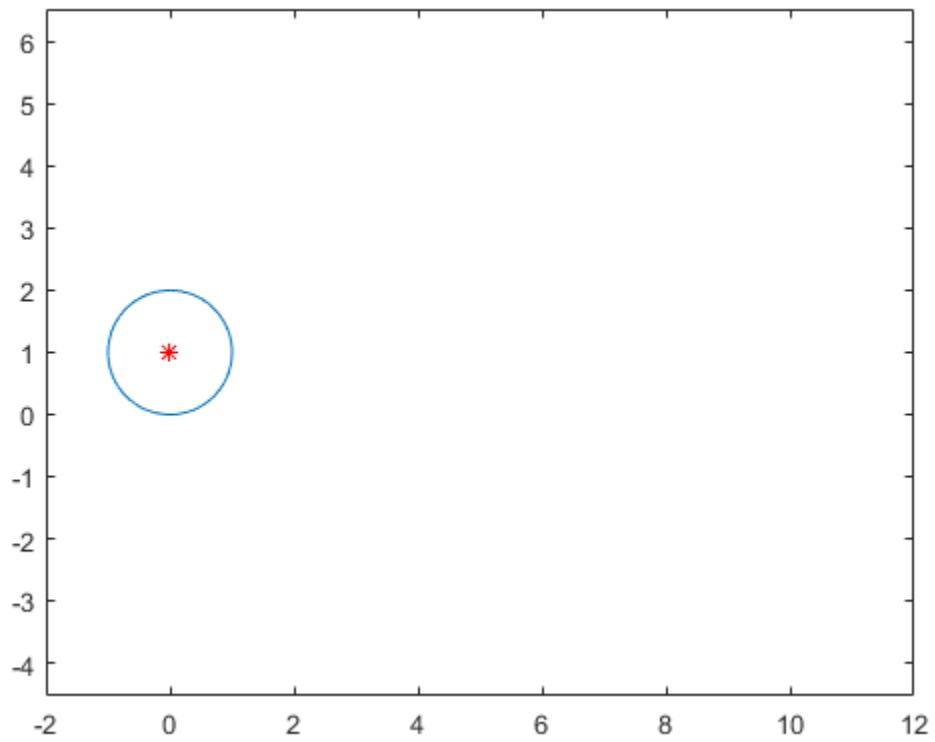

Enter the command `playAnimation` to play the animation. By default, `f Animator` creates an animation object, generating 10 frames per unit time within the range of `t` from 0 to 10.

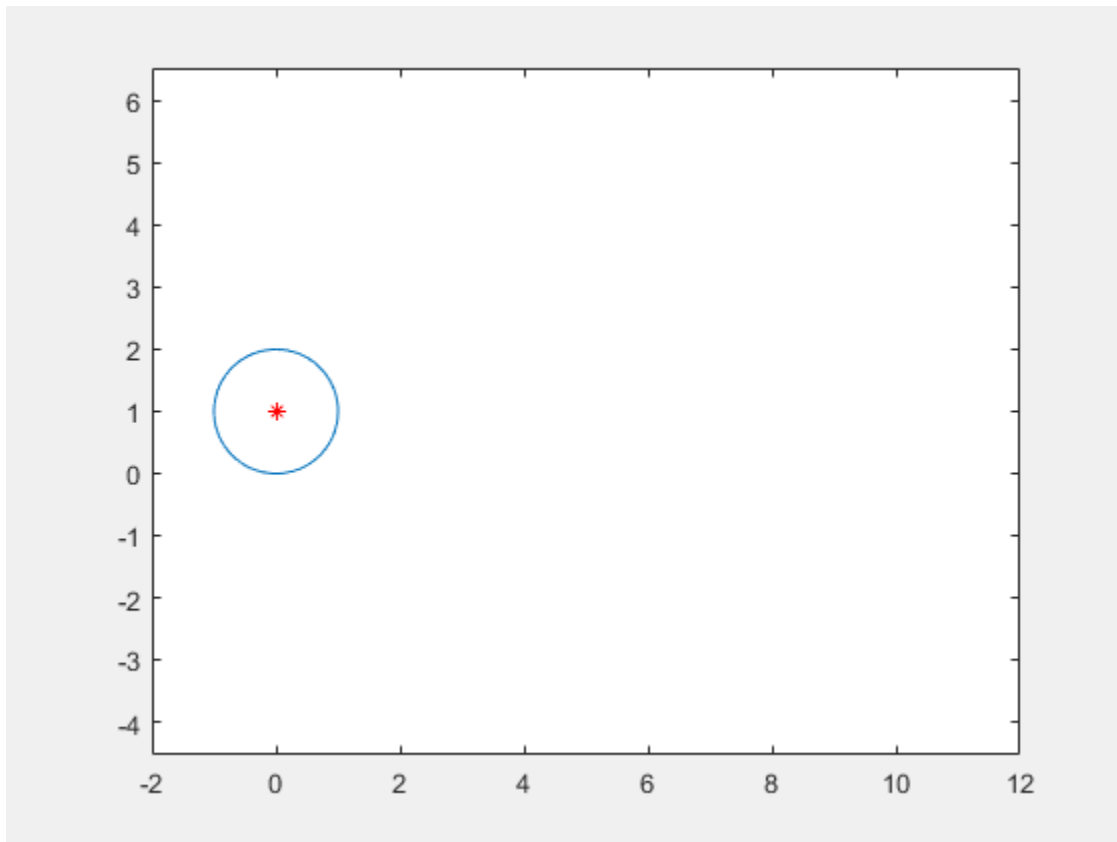

Create Animation of Changing Line

Animate a line that changes vertical length and line width. You can animate a specific graphics property by setting its value to depend on the animation time parameter. By default, the variable t is the time parameter of the animation.

Create two symbolic variables, y and t . Plot a line with y coordinates within the interval $[0 \ t]$ by using `fplot`. Use the `fanimator` function to create the line animation object. `fanimator` changes the line vertical length by increasing the value of t from 0 to 10.

```
syms y t
fanimator(@fplot,1,y,[0 t])
```

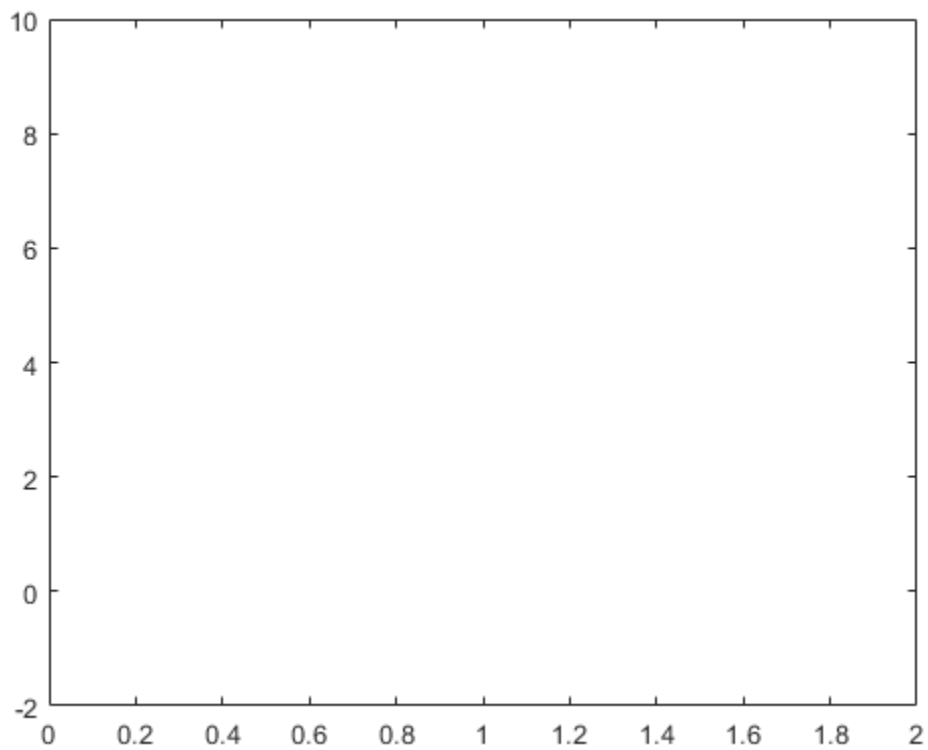

Enter the command `playAnimation` to play the animation.

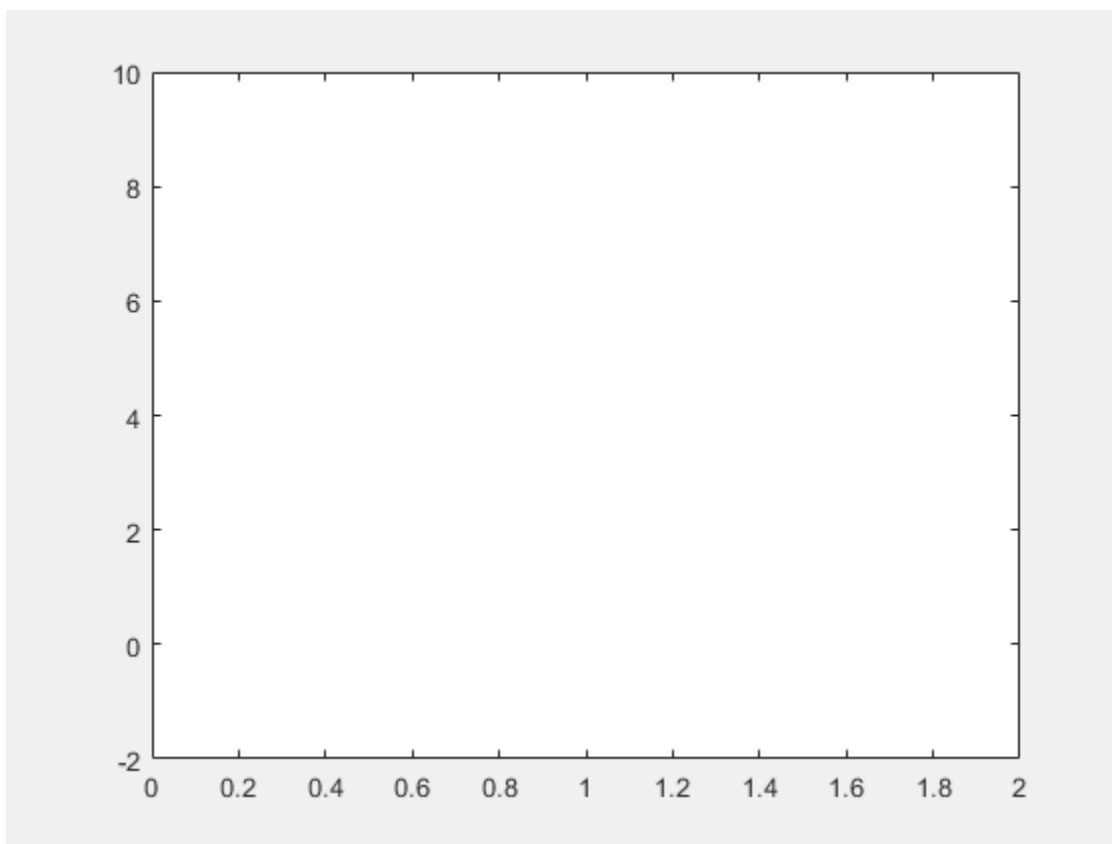

Now plot a line with y coordinates within the interval $[0 \ 2]$ by using `fplot`. Set the `'LineWidth'` property value to $t+1$. Use the `fanimator` function to create the line animation object. `fanimator` changes the line width by increasing the value of t from 0 to 10.

```
fanimator(@fplot,1,y,[0 2], 'LineWidth',t+1)
```

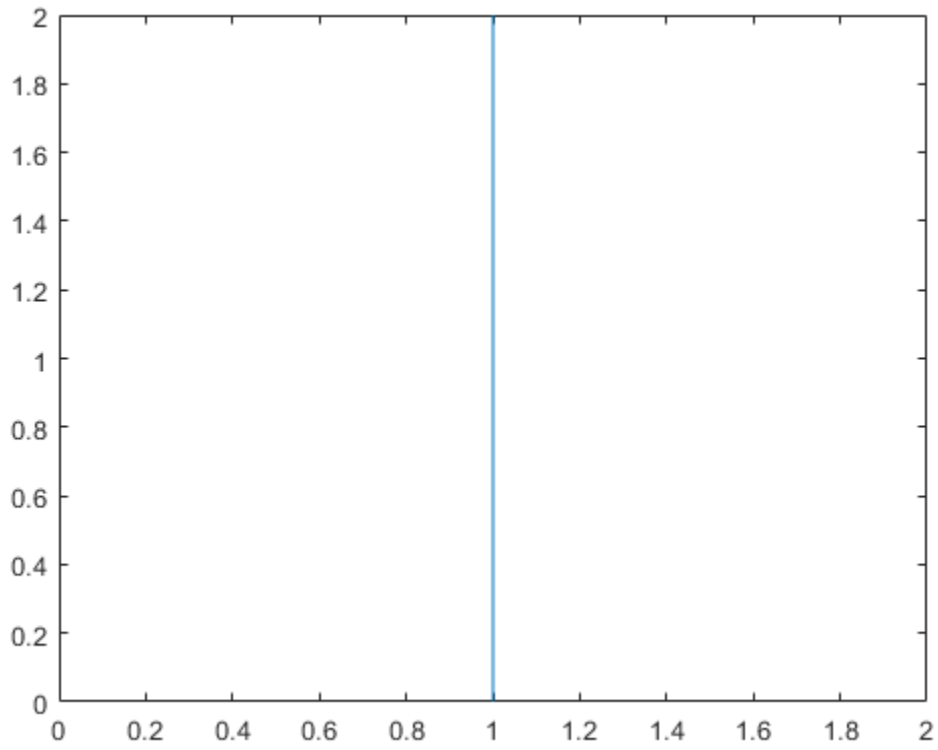

Enter the command `playAnimation` to play the animation.

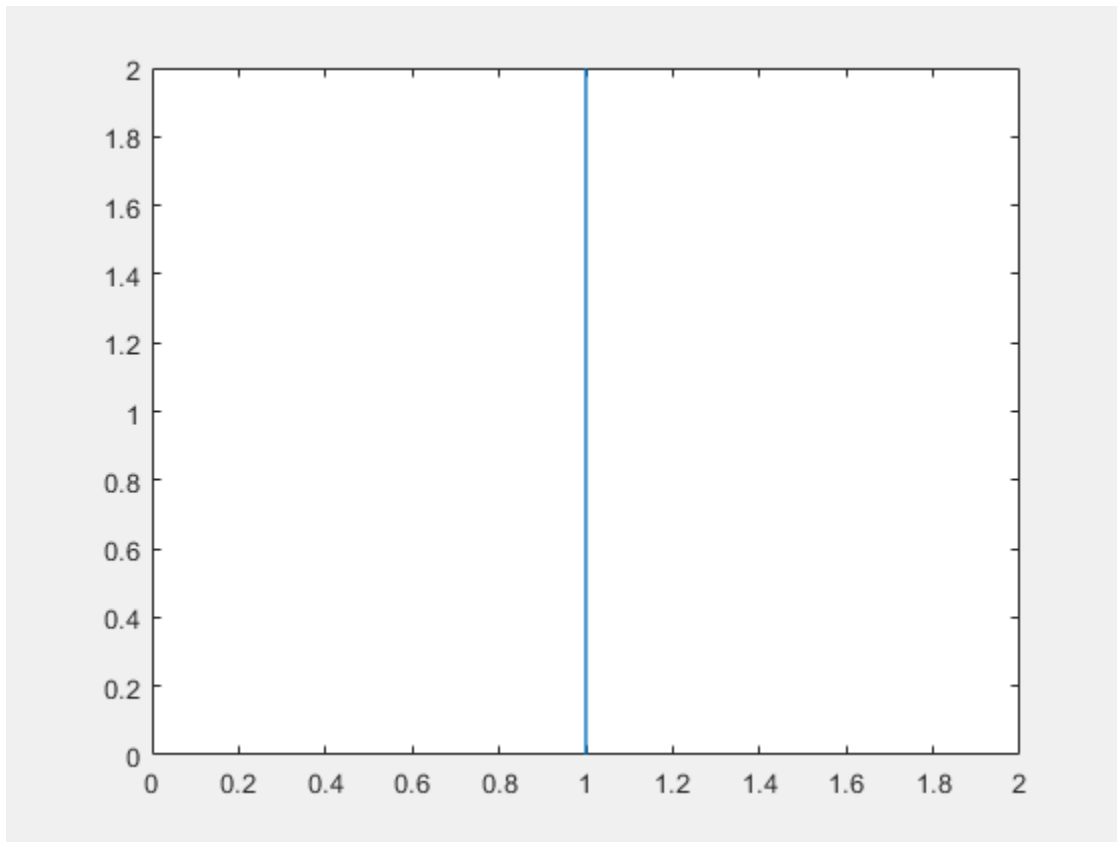

Create Animation of Circle with Timer

Animate a circle with a timer.

First, create a function that plots a unit circle and save it in a file named `circ.m`. The function uses `fplot` to plot a unit circle centered at $(t, 1)$, and the local symbolic variable `x` to parameterize the perimeter of the circle.

```
function C = circ(t)
    x = sym('x');
    C = fplot(cos(x)+t, sin(x)+1, [0 2*pi], 'Color', 'red');
end
```

Use `fanimator` to create a unit circle animation object. Set the animation range of the time parameter to `[2 4.5]` and the frame rate per unit time to 4. Set the x-axis and y-axis to be equal length.

```
fanimator(@circ, 'AnimationRange', [2 4.5], 'FrameRate', 4)
axis equal
```

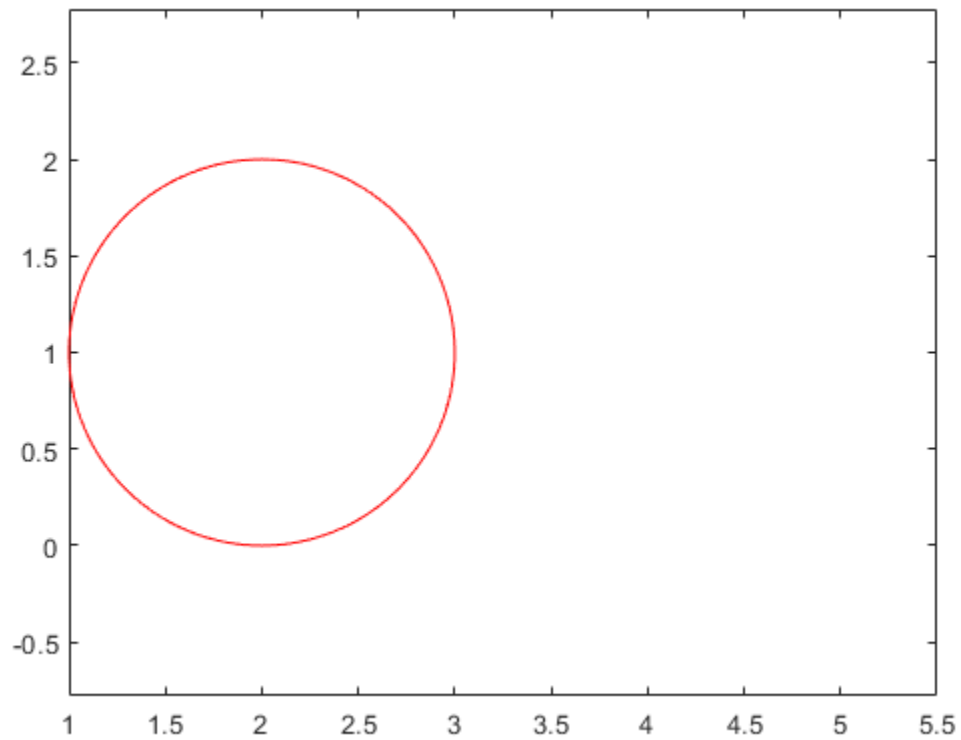

Next, add a timer animation object. Create a piece of text to count the elapsed time by using the `text` function. Use `num2str` to convert the time parameter to a string. Set the animation range of the timer to `[0 4.5]`.

```
hold on
f animator(@ (t) text(4.5,2.5,"Timer: "+num2str(t,2)), 'AnimationRange',[0 4.5])
hold off
```

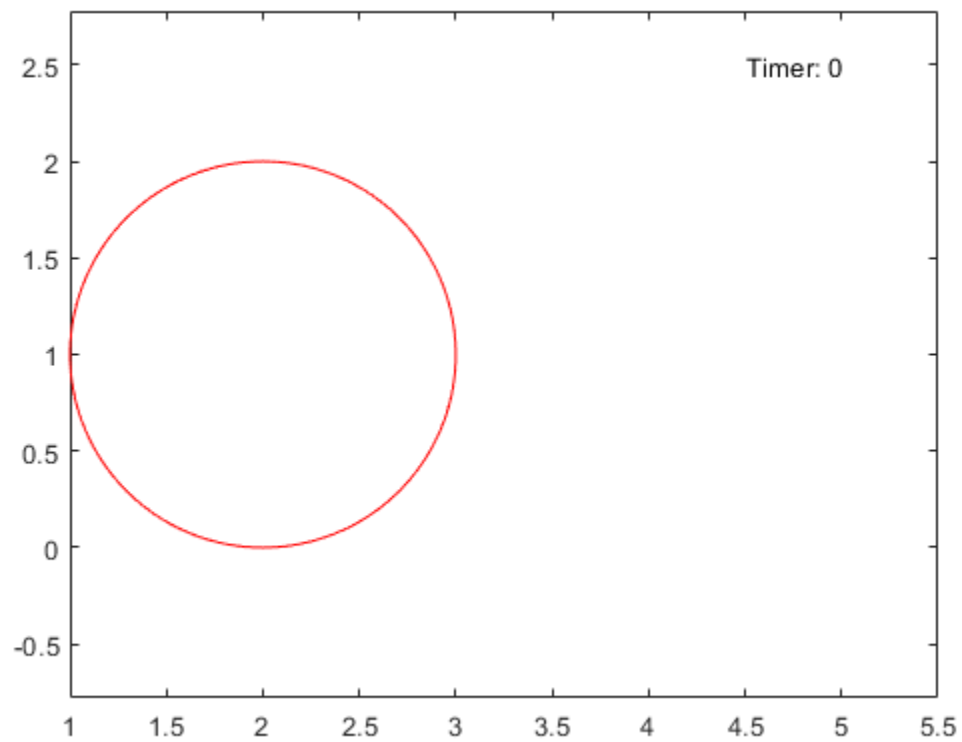

Enter the command `playAnimation` to play the animation. The timer counts the elapsed time from 0 to 4.5 seconds. The moving circle starts at 2 seconds and stops at 4.5 seconds.

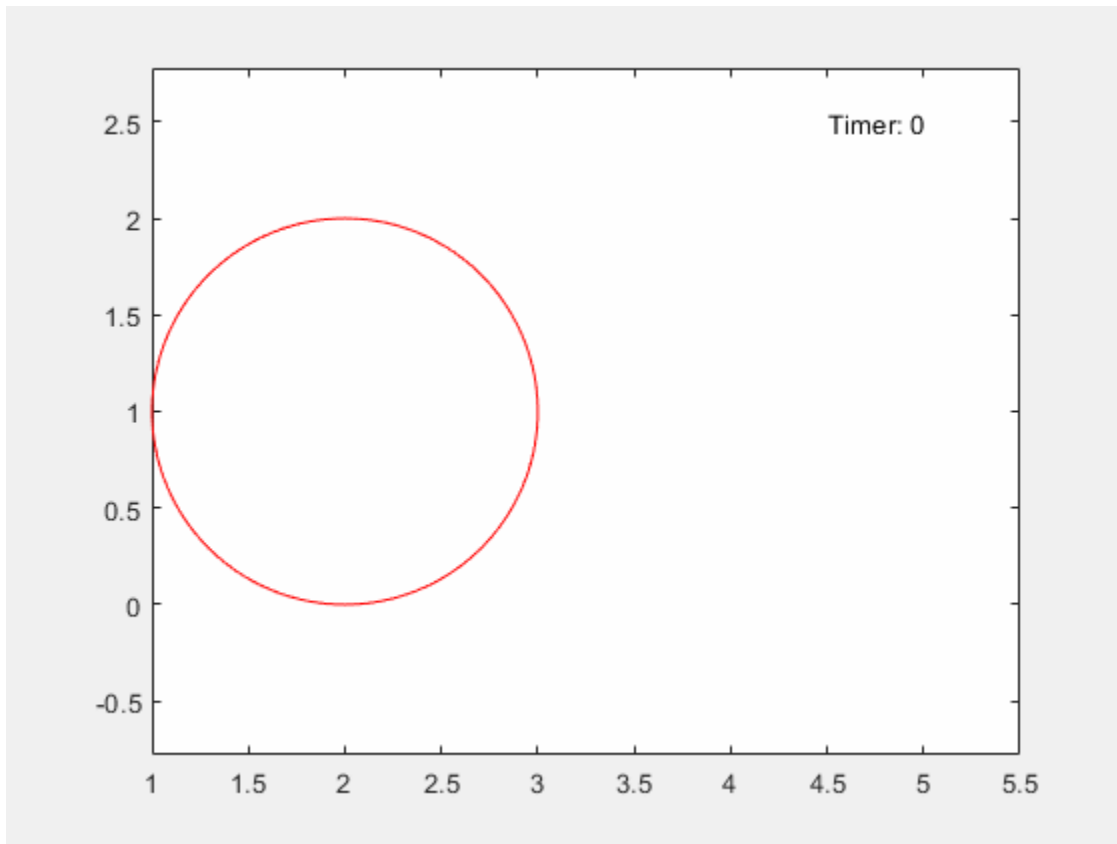

Create Animation of Cycloids

Animate two cycloids in separate axes. A cycloid is the curve traced by a fixed point on a circle as the circle moves along a straight line without slipping.

First, create two symbolic variables x and t . Create a figure with two subplots and return the first axes object as `ax1`. Create a moving circle animation object in `ax1` and add a fixed point on the rim of the circle. Set the x -axis and y -axis to be equal length.

```
syms x t
ax1 = subplot(2,1,1);
f animator(ax1, @fplot, cos(x)+t, sin(x)+1, [-pi pi])
axis equal
hold on
f animator(ax1, @(t) plot(t-sin(t), 1-cos(t), 'r*'))
```

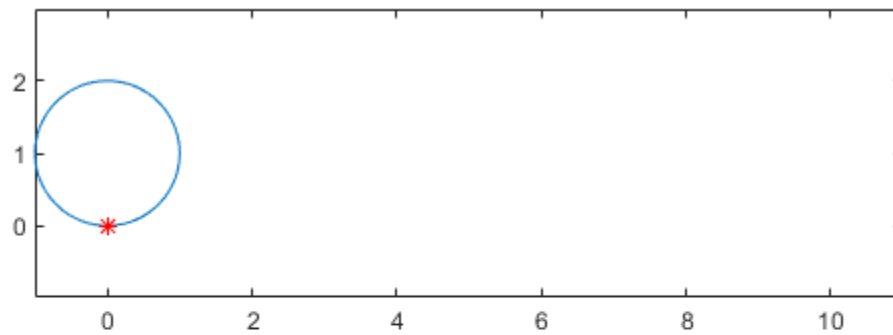
To trace the cycloid, use a time variable in the plotting interval. The `fplot` function plots a curve within the interval $[0 \ t]$. Create the cycloid animation object. By default, `fanimator` creates stop-motion frames within the range of t from 0 to 10 seconds. `fanimator` plots the first frame at t equal to 0.

```
fanimator(ax1, @fplot, x-sin(x), 1-cos(x), [0 t], 'k')  
hold off
```

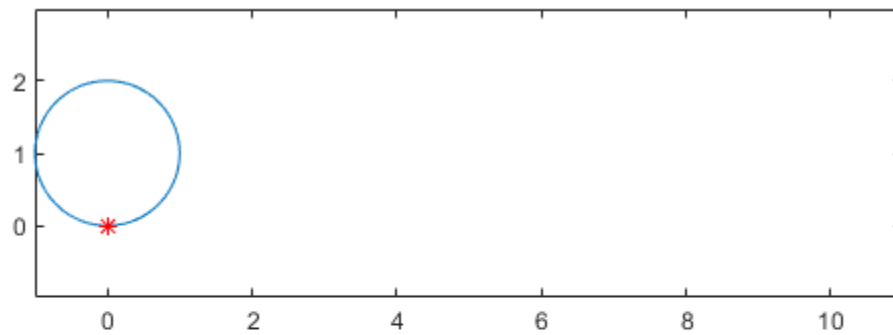

Next, create another cycloid on the second axes object `ax2`. Trace the curve created by a fixed point at a distance of $1/2$ from the center of the circle. Set the x-axis and y-axis to be equal length.

```
ax2 = subplot(2,1,2);
f animator(ax2, @fplot, cos(x)+t, sin(x)+1, [-pi pi])
axis equal
hold on
f animator(ax2, @(t) plot(t-sin(t)/2, 1-cos(t)/2, 'r*'))
f animator(ax2, @fplot, x-sin(x)/2, 1-cos(x)/2, [0 t], 'k')
hold off
```

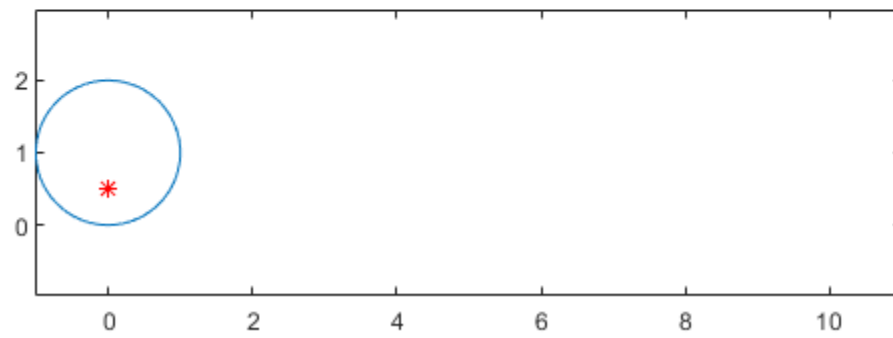
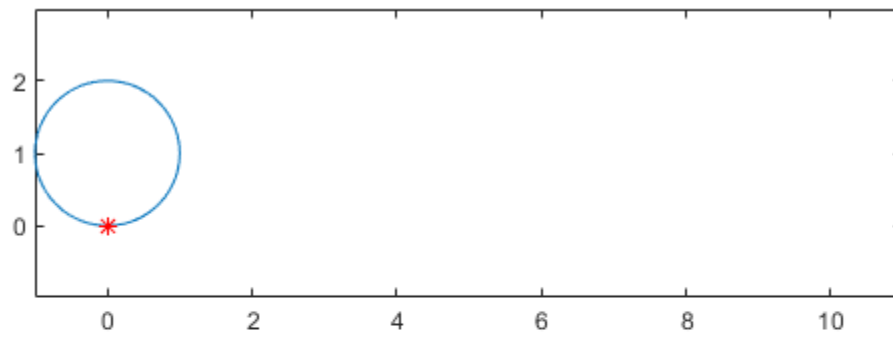

Enter the command `playAnimation` to play the animation.

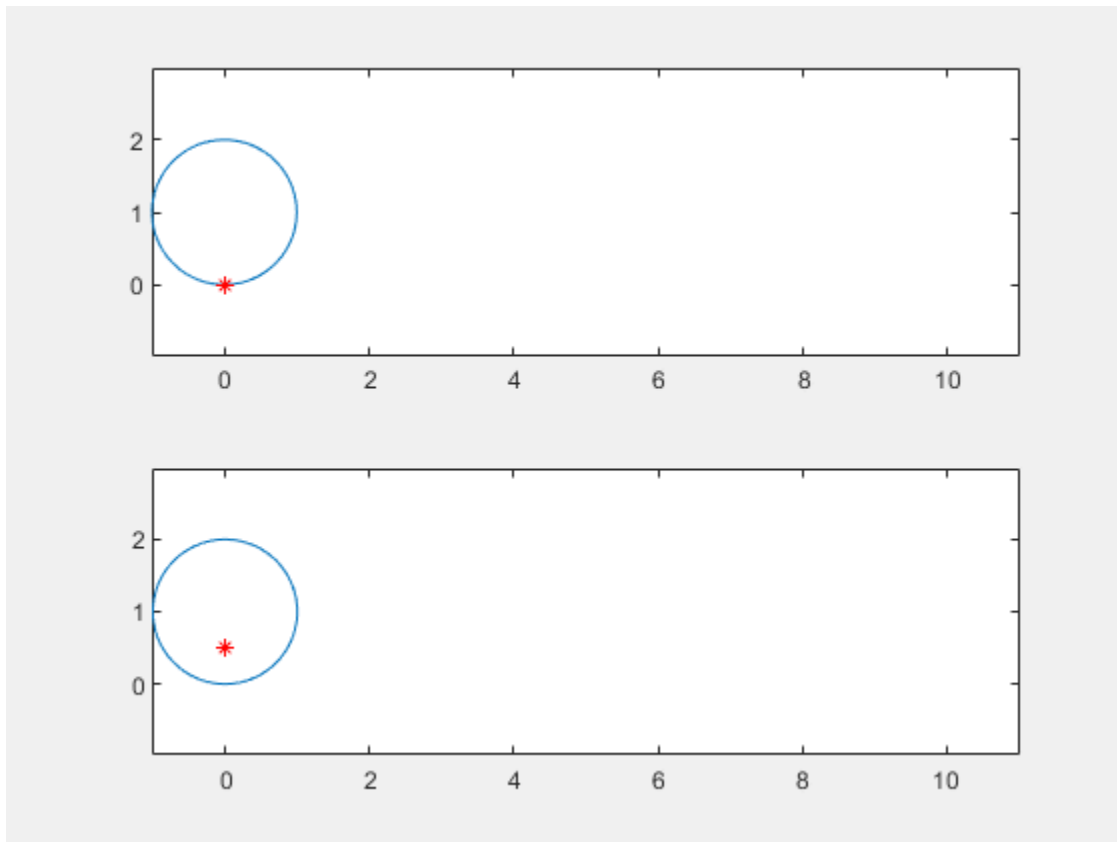

Create Animation in UI Figure

Create a UI figure. Specify the UI axes of the figure.

```
fig = uifigure;
ax = uiaxes(fig);
```

Add an animation object to the UI axes using `fanimate`. Create two symbolic variables, `x` and `t`. Plot a curve that grows exponentially as a function of time `t` within the interval `[0 3]`.

```
syms x t;
fanimate(ax,@fplot,exp(x),[0 t],'r','AnimationRange',[0 3])
```

Play the animation in the UI figure `fig` by entering the command `playAnimation(fig)`. Alternatively, you can also use the command `playAnimation(ax.Parent)`.

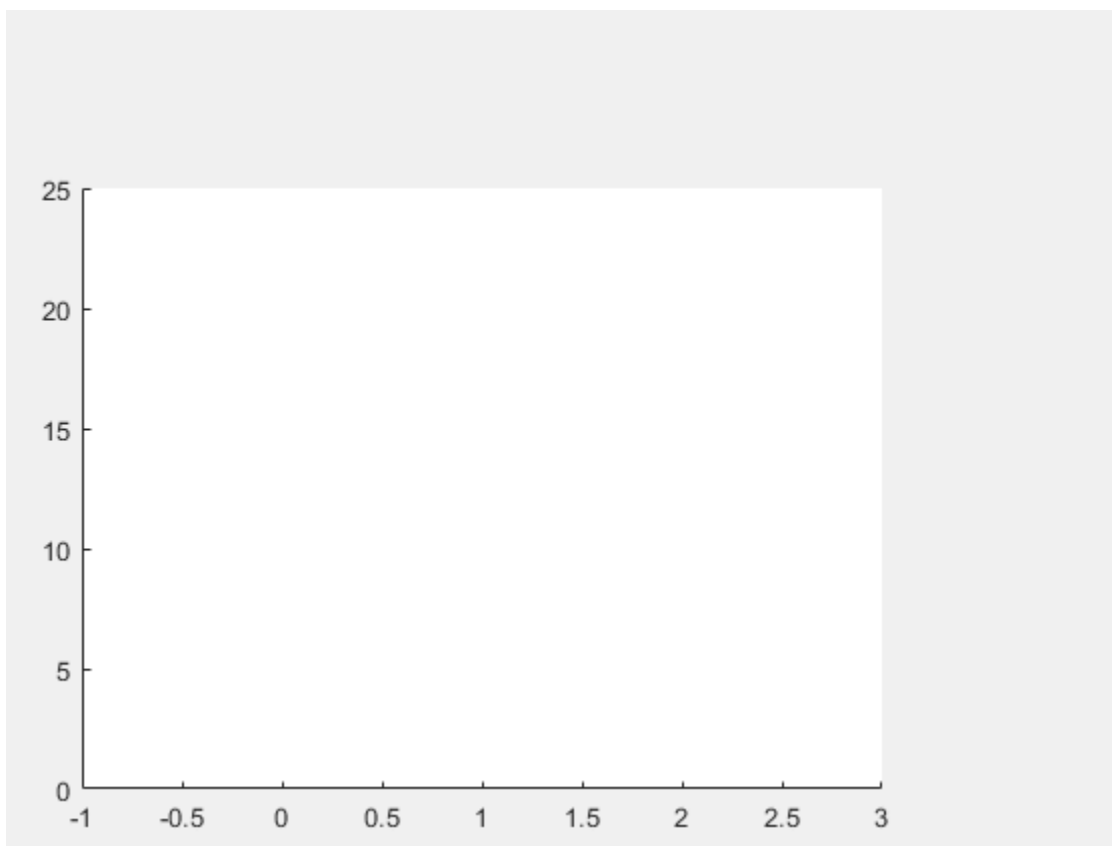

Copyright 2018 The MathWorks, Inc.

Input Arguments

f — Function returning graphics objects

function handle

Function returning graphics objects, specified as a function handle. For more information about function handles, see “Create Function Handle” (MATLAB).

args — Further arguments

input arguments

Further arguments, specified as input arguments of a function handle that returns the graphics objects.

ax — Target axes

Axes object

Target axes, specified as an Axes object. For more information about Axes objects, see `axes`.

Name-Value Pair Arguments

Specify optional comma-separated pairs of `Name`, `Value` arguments. `Name` is the argument name and `Value` is the corresponding value. `Name` must appear inside quotes. You can specify several name and value pair arguments in any order as `Name1, Value1, ..., NameN, ValueN`.

Example: `'AnimationRange', [2 8], 'FrameRate', 30`

AnimationParameter — Animation time parameter

`sym('t')` (default) | symbolic variable

Animation time parameter, specified as a symbolic variable.

Example: `sym('y')`

AnimationRange — Range of animation time parameter

`[0 10]` (default) | two-element row vector

Range of the animation time parameter, specified as a two-element row vector. The two elements must be real values that are increasing.

Example: `[-2 4.5]`

FrameRate — Frame rate

`10` (default) | positive value

Frame rate, specified as a positive value. The frame rate defines the number of frames per unit time for the animation object.

Example: `30`

Output Arguments

fp — Animation object

scalar

Animation object, returned as a scalar. You can use this object to query and modify the properties of the generated animation frames. For a list of properties, see [Animator Properties](#).

Tips

- When you create a graph by using a plotting function, such as `fplot`, MATLAB creates a series of graphics objects. You can then animate a specific property of the graphics objects by using the `fanimate` and the `playAnimation` functions. Note that some functions, such as `title` and `xlabel`, create text objects that cannot be animated. Instead, use the `text` function to create text objects that can be animated.

See Also

`animationToFrame` | `playAnimation` | `rewindAnimation` | `writeAnimation`

Introduced in R2019a

fcontour

Plot contours

Syntax

```
fcontour(f)
fcontour(f,[min max])
fcontour(f,[xmin xmax ymin ymax])
```

```
fcontour( ___,LineStyleSpec)
fcontour( ___,Name,Value)
fcontour(ax, ___)
fc = fcontour( ___ )
```

Description

`fcontour(f)` plots the contour lines of symbolic expression $f(x,y)$ over the default interval of x and y , which is $[-5\ 5]$.

`fcontour(f,[min max])` plots f over the interval $\min < x < \max$ and $\min < y < \max$.

`fcontour(f,[xmin xmax ymin ymax])` plots f over the interval $x_{\min} < x < x_{\max}$ and $y_{\min} < y < y_{\max}$. The `fcontour` function uses `symvar` to order the variables and assign intervals.

`fcontour(___,LineStyleSpec)` uses `LineStyleSpec` to set the line style and color. `fcontour` doesn't support markers.

`fcontour(___,Name,Value)` specifies line properties using one or more `Name,Value` pair arguments. Use this option with any of the input argument combinations in the previous syntaxes. `Name,Value` pair settings apply to all the lines plotted. To set options for individual plots, use the objects returned by `fcontour`.

`fcontour(ax, ___)` plots into the axes object `ax` instead of the current axes object `gca`.

`fc = fcontour(___)` returns a function contour object. Use the object to query and modify properties of a specific contour plot. For details, see [Function Contour](#).

Examples

Plot Contours of Symbolic Expression

Plot the contours of $\sin(x) + \cos(y)$ over the default range of $-5 < x < 5$ and $-5 < y < 5$. Show the colorbar. Find a contour's level by matching the contour's color with the colorbar value.

```
syms x y
fcontour(sin(x) + cos(y))
colorbar
```

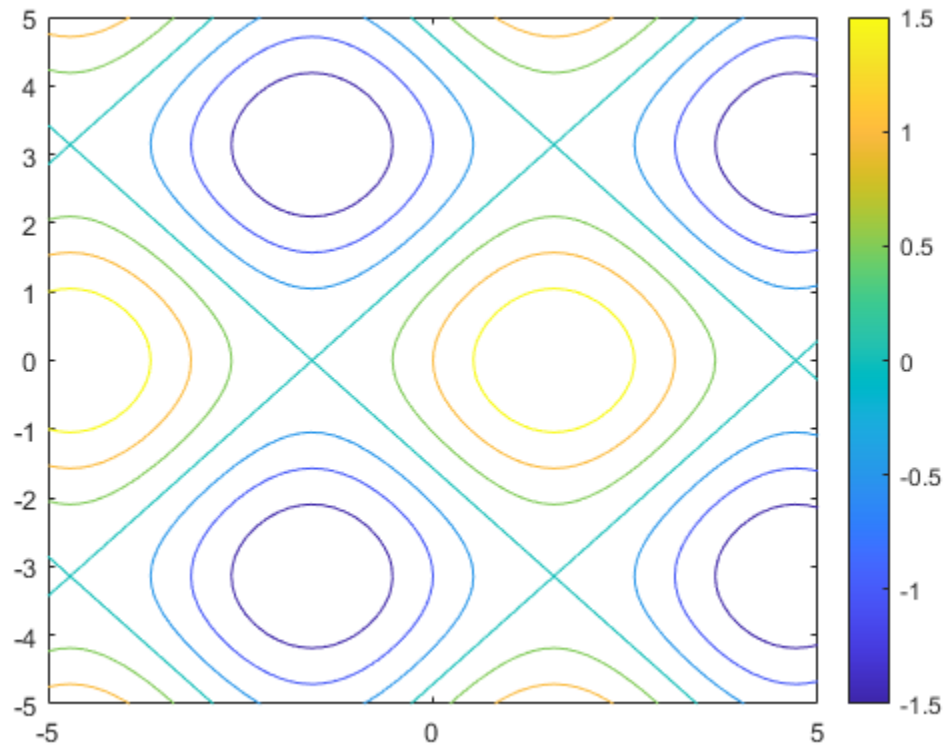

Plot Contours of Symbolic Function

Plot the contours of $f(x, y) = \sin(x) + \cos(y)$ over the default range of $-5 < x < 5$ and $-5 < y < 5$.

```
syms f(x,y)
f(x,y) = sin(x) + cos(y);
fcontour(f)
```

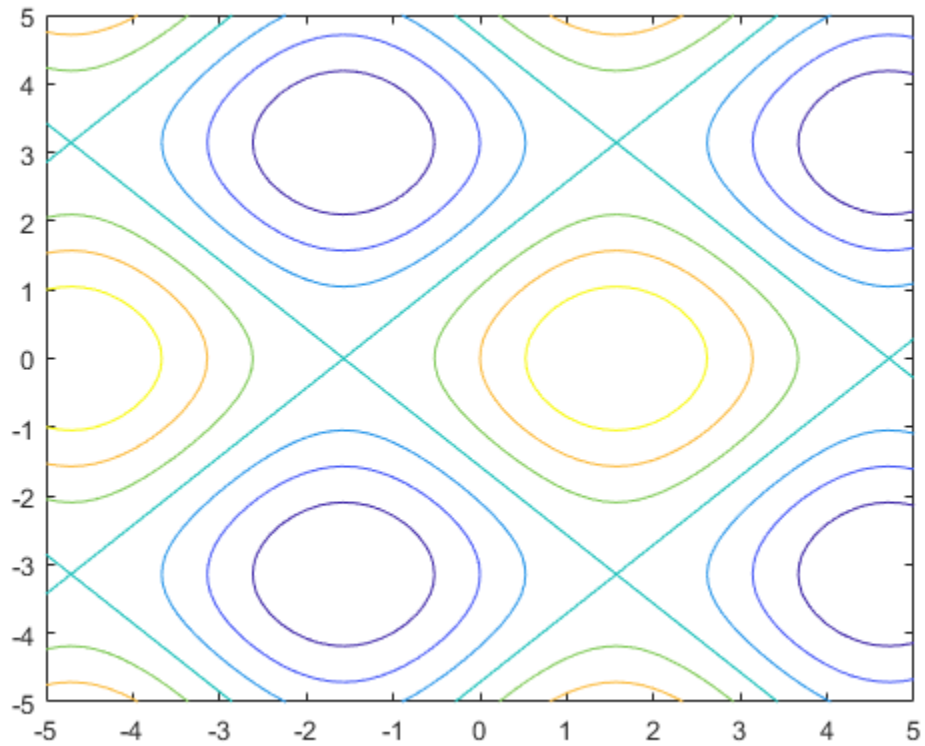
Specify Plotting Interval

Plot $\sin(x) + \cos(y)$ over $-\pi/2 < x < \pi/2$ and $0 < y < 5$ by specifying the plotting interval as the second argument of `fcontour`.

```
syms x y
f = sin(x) + cos(y);
fcontour(f, [-pi/2 pi/2 0 5])
```

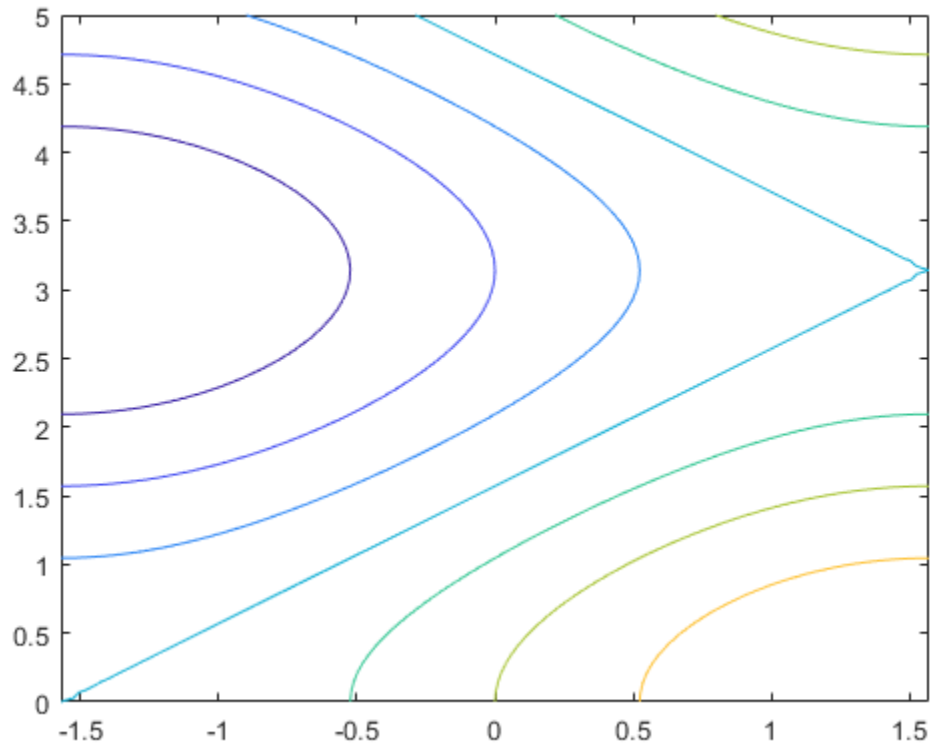

Change Line Style, Color and Width

Plot the contours of $x^2 - y^2$ as blue, dashed lines by specifying the `LineStyle` input. Specify a `LineWidth` of 2. Markers are not supported by `fcontour`.

```
syms x y  
fcontour(x^2 - y^2, '--b', 'LineWidth', 2)
```

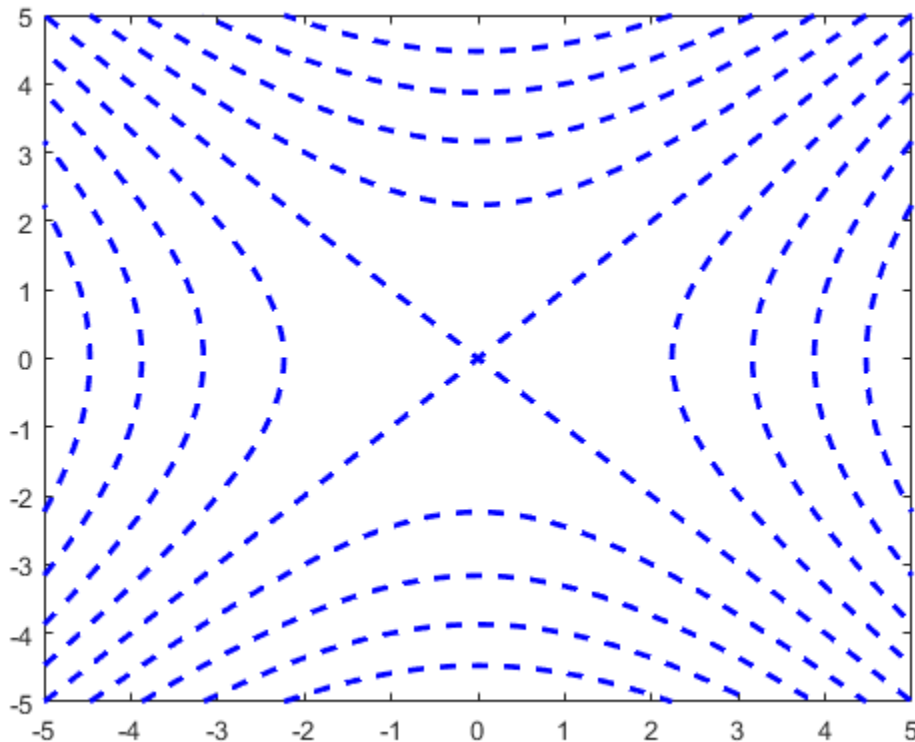

Plot Multiple Contour Plots on Same Figure

Plot multiple contour plots either by passing the inputs as a vector or by using `hold on` to successively plot on the same figure. If you specify `LineStyle` and Name-Value arguments, they apply to all contour plots. You cannot specify individual `LineStyle` and Name-Value pair arguments for each plot.

Divide a figure into two subplots by using `subplot`. On the first subplot, plot $\sin(x) + \cos(y)$ and $x - y$ by using vector input. On the second subplot, plot the same expressions by using `hold on`.

```
syms x y
subplot(2,1,1)
fcontour([sin(x)+cos(y) x-y])
title('Multiple Contour Plots Using Vector Inputs')
```

```
subplot(2,1,2)
fcontour(sin(x)+cos(y))
hold on
fcontour(x-y)
title('Multiple Contour Plots Using Hold Command')
```

```
hold off
```

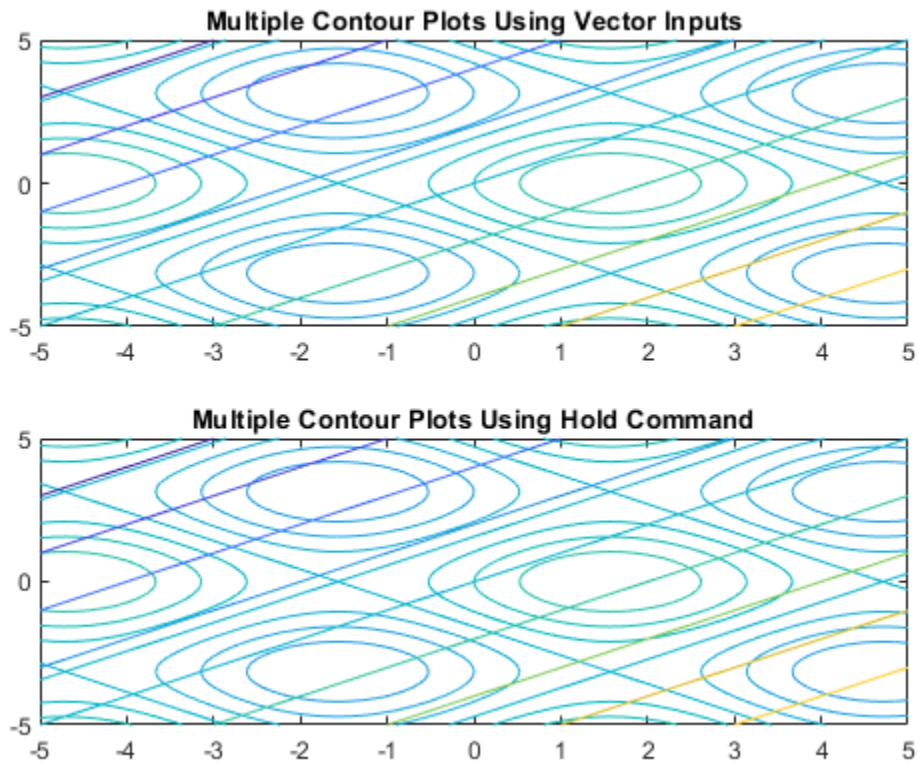

Modify Contour Plot After Creation

Plot the contours of $e^{-(x/3)^2 - (y/3)^2} + e^{-(x+2)^2 - (y+2)^2}$. Specify an output to make `fcontour` return the plot object.

```
syms x y
f = exp(-(x/3)^2 - (y/3)^2) + exp(-(x+2)^2 - (y+2)^2);
fc = fcontour(f)
```

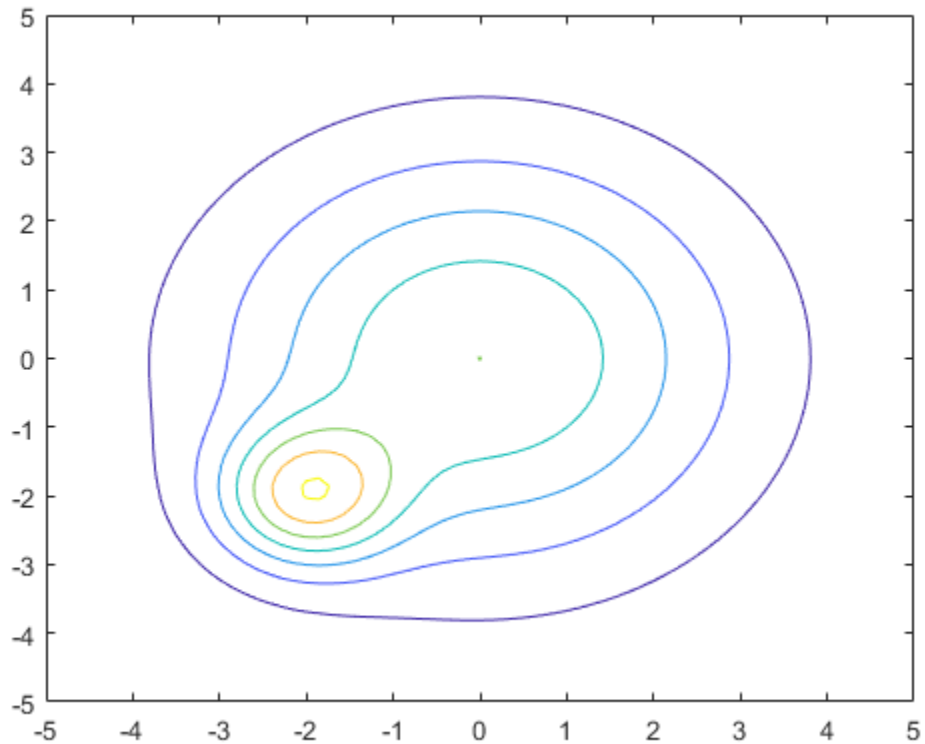

```
fc =
  FunctionContour with properties:
    Function: [1x1 sym]
    LineColor: 'flat'
    LineStyle: '-'
    LineWidth: 0.5000
    Fill: off
    LevelList: [0.2000 0.4000 0.6000 0.8000 1 1.2000 1.4000]
```

Show all properties

Change the `LineWidth` to 1 and the `LineStyle` to a dashed line by using dot notation to set properties of the object `fc`. Visualize contours close to 0 and 1 by setting `LevelList` to `[1 0.9 0.8 0.2 0.1]`.

```
fc.LineStyle = '--';
fc.LineWidth = 1;
fc.LevelList = [1 0.9 0.8 0.2 0.1];
colorbar
```

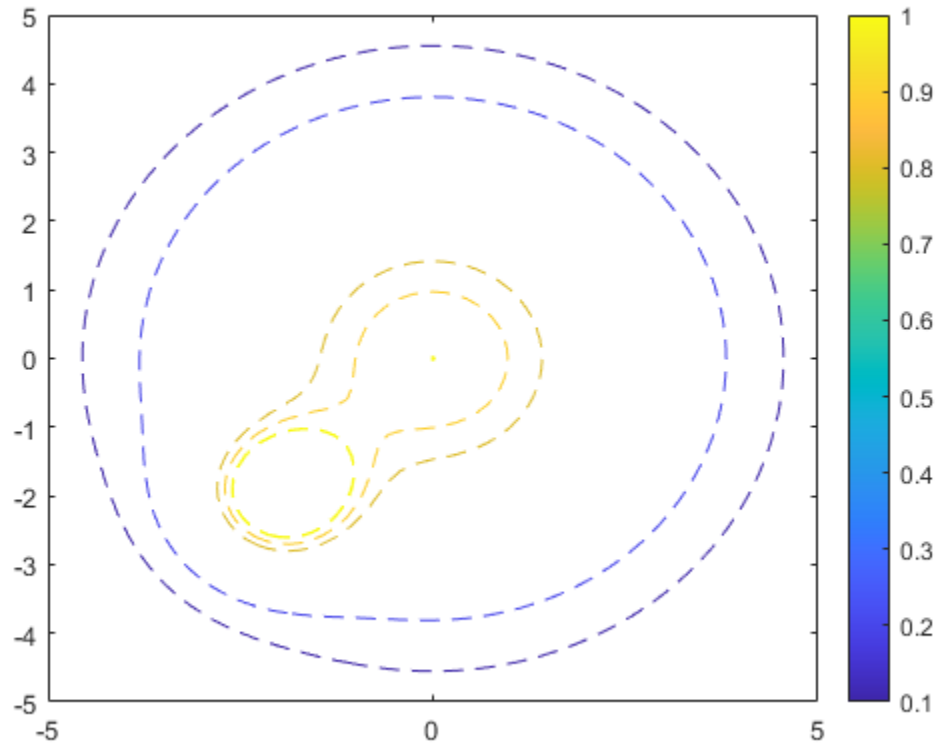

Fill Area Between Contours

Fill the area between contours by setting the `Fill` input of `fcontour` to `'on'`. If you want interpolated shading instead, use the `fsurf` function with its option `'EdgeColor'` set to `'none'` followed by the command `view(0,90)`.

Create a plot that looks like a sunset by filling the contours of

$$\operatorname{erf}((y+2)^3) - e^{-0.65((x-2)^2 + (y-2)^2)}.$$

```
syms x y
f = erf((y+2)^3) - exp(-0.65*((x-2)^2+(y-2)^2));
fcontour(f, 'Fill', 'on')
```

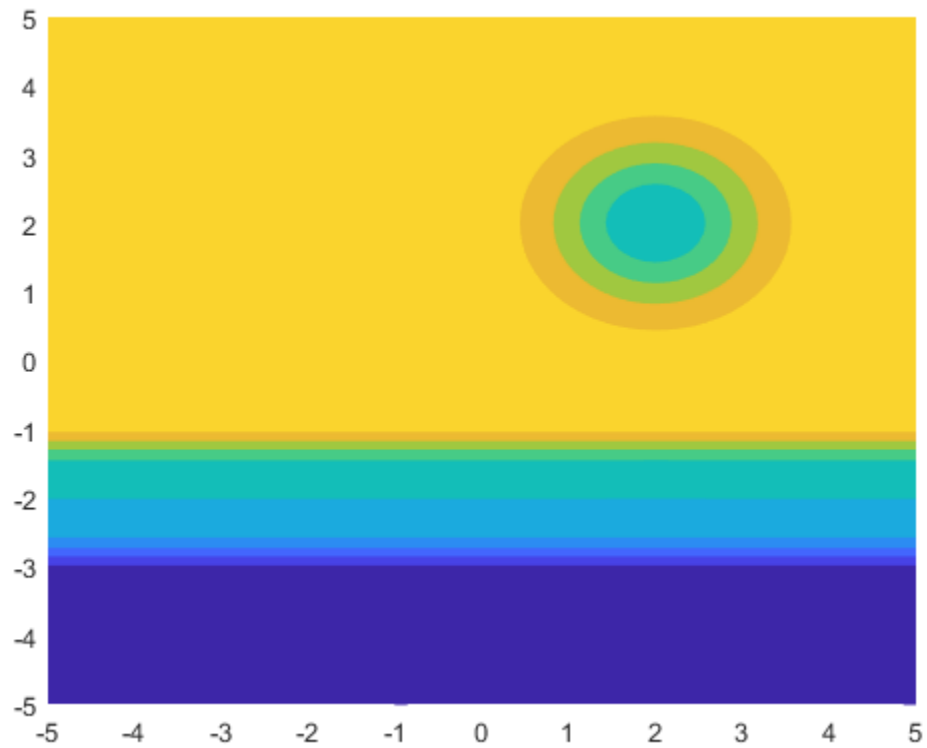

Specify Levels for Contour Lines

Set the values at which `fcontour` draws contours by using the `'LevelList'` option.

```
syms x y
f = sin(x) + cos(y);
fcontour(f, 'LevelList', [-1 0 1])
```

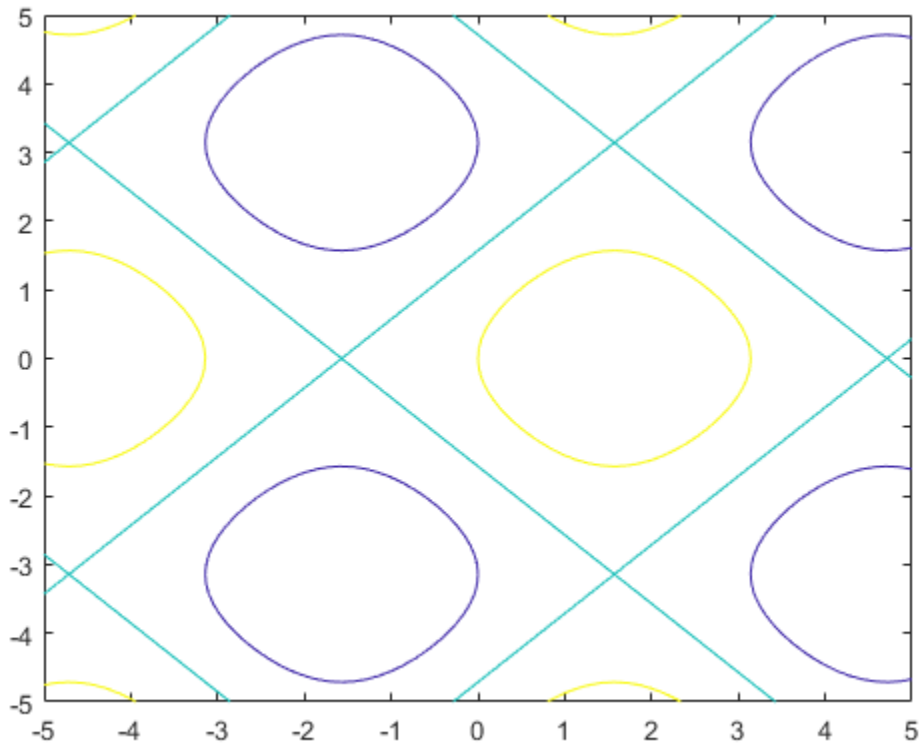

Control Resolution of Contour Lines

Control the resolution of contour lines by using the 'MeshDensity' option. Increasing 'MeshDensity' can make smoother, more accurate plots while decreasing it can increase plotting speed.

Divide a figure into two using `subplot`. In the first subplot, plot the contours of $\sin(x)\sin(y)$. The corners of the squares do not meet. To fix this issue, increase 'MeshDensity' to 200 in the second subplot. The corners now meet, showing that by increasing 'MeshDensity' you increase the plot's resolution.

```
syms x y
subplot(2,1,1)
fcontour(sin(x).*sin(y))
title('Default MeshDensity = 71')

subplot(2,1,2)
fcontour(sin(x).*sin(y), 'MeshDensity', 200)
title('Increased MeshDensity = 200')
```

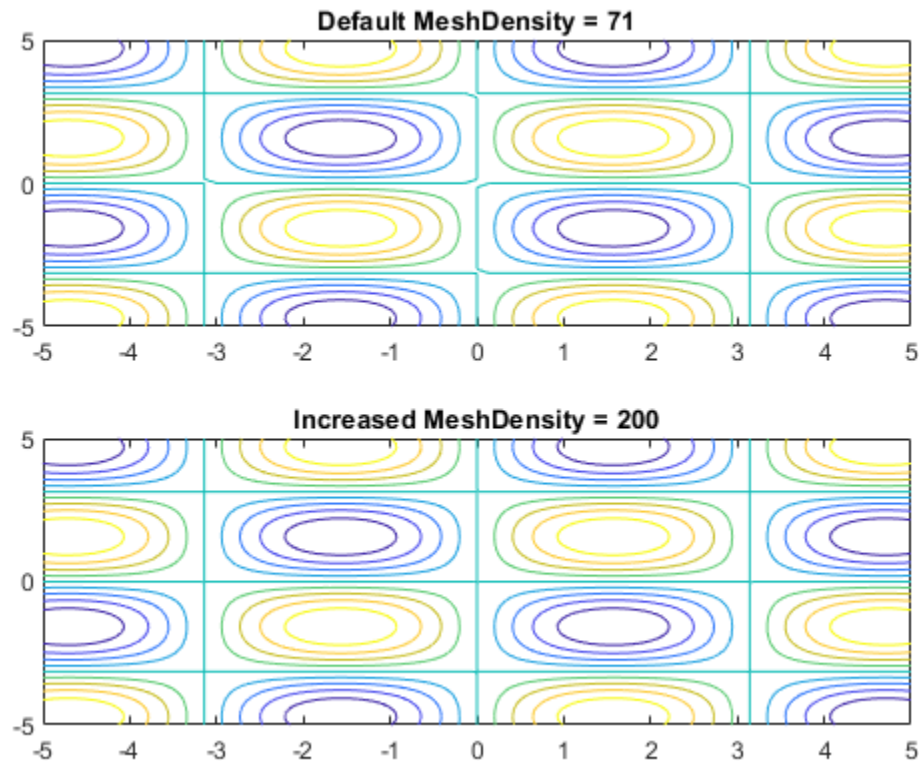
Add Title and Axis Labels and Format Ticks

Plot $x\sin(y) - y\cos(x)$. Add a title and axis labels. Create the x-axis ticks by spanning the x-axis limits at intervals of $\pi/2$. Display these ticks by using the `XTick` property. Create x-axis labels by using `arrayfun` to apply `texlabel` to `S`. Display these labels by using the `XTickLabel` property. Repeat these steps for the y-axis.

To use LaTeX in plots, see `latex`.

```
syms x y
fcontour(x*sin(y)-y*cos(x), [-2*pi 2*pi])
grid on
title('xsin(y)-ycos(x) for  $-2\pi < x < 2\pi$  and  $-2\pi < y < 2\pi$ ')
xlabel('x')
ylabel('y')
ax = gca;

S = sym(ax.XLim(1):pi/2:ax.XLim(2));
ax.XTick = double(S);
ax.XTickLabel = arrayfun(@texlabel, S, 'UniformOutput', false);

S = sym(ax.YLim(1):pi/2:ax.YLim(2));
ax.YTick = double(S);
ax.YTickLabel = arrayfun(@texlabel, S, 'UniformOutput', false);
```

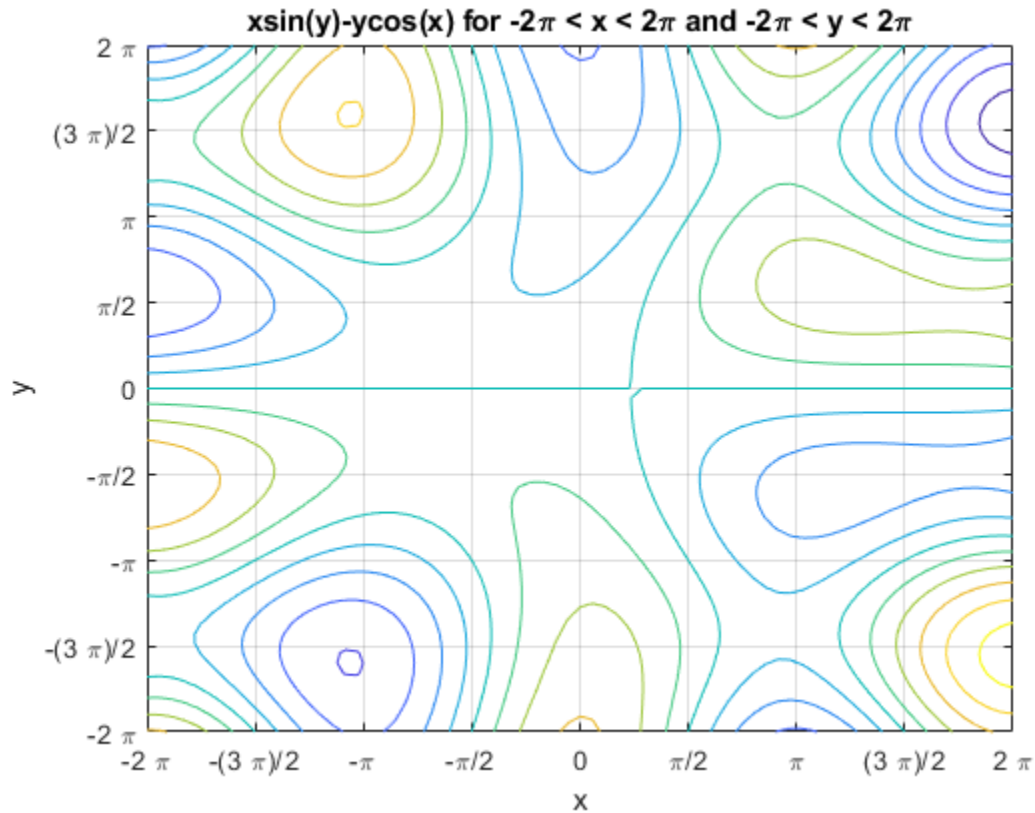

Create Animations

Create animations by changing the displayed expression using the `Function` property of the function handle, and then using `drawnow` to update the plot. To export to GIF, see `imwrite`.

By varying the variable i from $-\pi/8$ to $\pi/8$, animate the parametric curve $i\sin(x) + i\cos(y)$.

```
syms x y
fc = fcontour(-pi/8.*sin(x)-pi/8.*cos(y));
for i=-pi/8:0.01:pi/8
    fc.Function = i.*sin(x)+i.*cos(y);
    drawnow
    pause(0.05)
end
```

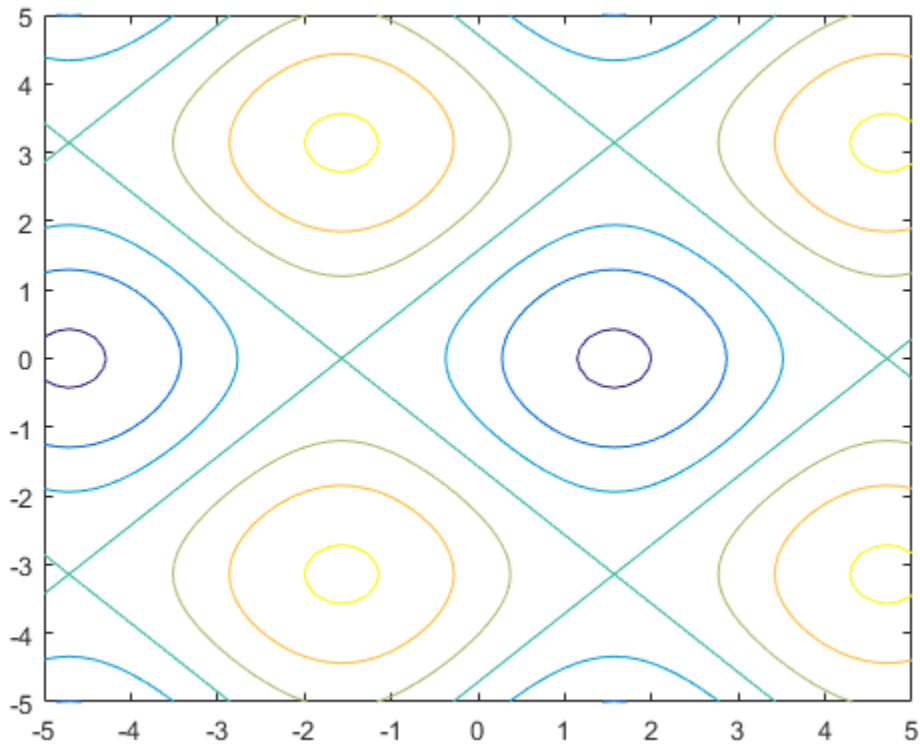

Input Arguments

f — Expression or function to be plotted

symbolic expression | symbolic function

Expression or function to be plotted, specified as a symbolic expression or function.

[min max] — Plotting range for x and y

[-5 5] (default) | vector of two numbers

Plotting range for x and y, specified as a vector of two numbers. The default range is [-5 5].

[xmin xmax ymin ymax] — Plotting range for x and y

[-5 5 -5 5] (default) | vector of four numbers

Plotting range for x and y, specified as a vector of four numbers. The default range is [-5 5 -5 5].

ax — Axes object

axes object

Axes object. If you do not specify an axes object, then the plot function uses the current axes.

LineStyle — Line style and color

character vector | string

Line style and color, specified as a character vector or string containing a line style specifier, a color specifier, or both.

Example: `'- - r'` specifies red dashed lines

These two tables list the line style and color options.

Line Style Specifier	Description
-	Solid line (default)
- -	Dashed line
:	Dotted line
- .	Dash-dot line

Color Specifier	Description
y	yellow
m	magenta
c	cyan
r	red
g	green
b	blue
w	white
k	black

Name-Value Pair Arguments

Specify optional comma-separated pairs of `Name`, `Value` arguments. `Name` is the argument name and `Value` is the corresponding value. `Name` must appear inside quotes. You can specify several name and value pair arguments in any order as `Name1, Value1, ..., NameN, ValueN`.

Example: `'MeshDensity', 30`

The properties listed here are only a subset. For a complete list, see Function `Contour`.

MeshDensity — Number of evaluation points per direction

71 (default) | number

Number of evaluation points per direction, specified as a number. The default is 71. Because `fcontour` uses adaptive evaluation, the actual number of evaluation points is greater.

Example: 30

Fill — Fill between contour lines

'off' (default) | on/off logical value

Fill between contour lines, specified as `'on'` or `'off'`, or as numeric or logical 1 (true) or 0 (false). A value of `'on'` is equivalent to true, and `'off'` is equivalent to false. Thus, you can use the value of this property as a logical value. The value is stored as an on/off logical value of type `matlab.lang.OnOffSwitchState`.

- A value of `'on'` fill the spaces between contour lines with color.

- A value of 'off' leaves the spaces between the contour lines unfilled.

LevelList — Contour levels

vector of z values

Contour levels, specified as a vector of z values. By default, the `fcontour` function chooses values that span the range of values in the `ZData` property.

Setting this property sets the associated mode property to manual.

Data Types: `single` | `double` | `int8` | `int16` | `int32` | `int64` | `uint8` | `uint16` | `uint32` | `uint64`

LevelListMode — Selection mode for LevelList

'auto' (default) | 'manual'

Selection mode for the `LevelList`, specified as one of these values:

- 'auto' — Determine the values based on the `ZData` values.
- 'manual' — Use manually specified values. To specify the values, set the `LevelList` property. When the mode is 'manual', the `LevelList` values do not change if you change the `Function` property or the limits.

LevelStep — Spacing between contour lines

0 (default) | scalar numeric value

Spacing between contour lines, specified as a scalar numeric value. For example, specify a value of 2 to draw contour lines at increments of 2. By default, `LevelStep` is determined by using the `ZData` values.

Setting this property sets the associated mode property to 'manual'.

Example: 3.4

Data Types: `single` | `double` | `int8` | `int16` | `int32` | `int64` | `uint8` | `uint16` | `uint32` | `uint64`

LevelStepMode — Selection mode for LevelStep

'auto' (default) | 'manual'

Selection mode for the `LevelStep`, specified as one of these values:

- 'auto' — Determine the value based on the `ZData` values.
- 'manual' — Use a manually specified value. To specify the value, set the `LevelStep` property. When the mode is 'manual', the value of `LevelStepMode` does not change when the `Function` property or the limits change.

LineColor — Color of contour lines

'flat' (default) | RGB triplet | hexadecimal color code | 'r' | 'g' | 'b' | ...







Color of contour lines, specified as 'flat', an RGB triplet, a hexadecimal color code, a color name, or a short name. To use a different color for each contour line, specify 'flat'. The color is determined by the contour value of the line, the `colormap`, and the scaling of data values into the `colormap`. For more information on color scaling, see `caxis`.

To use the same color for all the contour lines, specify an RGB triplet, a hexadecimal color code, a color name, or a short name.





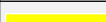

For a custom color, specify an RGB triplet or a hexadecimal color code.

- An RGB triplet is a three-element row vector whose elements specify the intensities of the red, green, and blue components of the color. The intensities must be in the range $[0, 1]$; for example, $[0.4 \ 0.6 \ 0.7]$.
- A hexadecimal color code is a character vector or a string scalar that starts with a hash symbol (#) followed by three or six hexadecimal digits, which can range from 0 to F. The values are not case sensitive. Thus, the color codes '#FF8800', '#ff8800', '#F80', and '#f80' are equivalent.

Alternatively, you can specify some common colors by name. This table lists the named color options, the equivalent RGB triplets, and hexadecimal color codes.

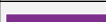
Color Name	Short Name	RGB Triplet	Hexadecimal Color Code	Appearance
'red'	'r'	[1 0 0]	'#FF0000'	
'green'	'g'	[0 1 0]	'#00FF00'	
'blue'	'b'	[0 0 1]	'#0000FF'	
'cyan'	'c'	[0 1 1]	'#00FFFF'	
'magenta'	'm'	[1 0 1]	'#FF00FF'	
'yellow'	'y'	[1 1 0]	'#FFFF00'	
'black'	'k'	[0 0 0]	'#000000'	
'white'	'w'	[1 1 1]	'#FFFFFF'	
'none'	Not applicable	Not applicable	Not applicable	No color

Here are the RGB triplets and hexadecimal color codes for the default colors MATLAB uses in many types of plots.



RGB Triplet	Hexadecimal Color Code	Appearance
[0 0.4470 0.7410]	'#0072BD'	
[0.8500 0.3250 0.0980]	'#D95319'	
[0.9290 0.6940 0.1250]	'#EDB120'	
[0.4940 0.1840 0.5560]	'#7E2F8E'	
[0.4660 0.6740 0.1880]	'#77AC30'	
[0.3010 0.7450 0.9330]	'#4DBEEE'	
[0.6350 0.0780 0.1840]	'#A2142F'	

LineStyle – Line style

'-' (default) | '--' | ':' | '-.' | 'none'

Line style, specified as one of the options listed in this table.

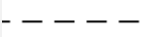
Line Style	Description	Resulting Line
'-'	Solid line	

Line Style	Description	Resulting Line
'--'	Dashed line	
':'	Dotted line	
'-.'	Dash-dotted line	
'none'	No line	No line

LineWidth – Line width

0.5 (default) | positive value

Line width, specified as a positive value in points, where 1 point = 1/72 of an inch. If the line has markers, then the line width also affects the marker edges.

The line width cannot be thinner than the width of a pixel. If you set the line width to a value that is less than the width of a pixel on your system, the line displays as one pixel wide.

Output Arguments

fc – One or more function contour objects

scalar | vector

One or more function contour objects, returned as a scalar or a vector. These objects are unique identifiers, which you can use to query and modify the properties of a specific contour plot. For details, see Function Contour.

Algorithms

fcontour assigns the symbolic variables in f to the x axis, then the y axis, and `symvar` determines the order of the variables to be assigned. Therefore, variable and axis names might not correspond. To force `fcontour` to assign x or y to its corresponding axis, create the symbolic function to plot, then pass the symbolic function to `fcontour`.

For example, the following code plots the contour of the surface $f(x,y) = \sin(y)$ in two ways. The first way forces the waves to oscillate with respect to the y axis. The second way assigns y to the x axis because it is the first (and only) variable in the symbolic function.

```
syms x y;
f(x,y) = sin(y);

figure;
subplot(2,1,1)
fcontour(f);
subplot(2,1,2)
fcontour(f(x,y)); % Or fcontour(sin(y));
```

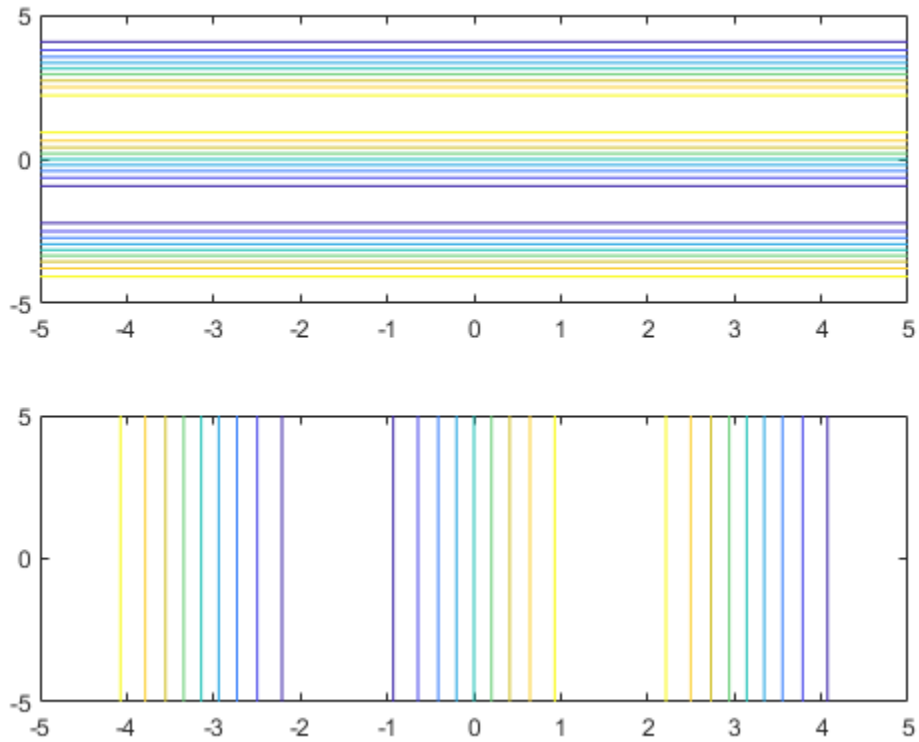

See Also

Functions

`fimplicit` | `fimplicit3` | `fmesh` | `fplot` | `fplot3` | `fsurf`

Properties

Function Contour

Topics

“Create Plots” on page 2-229

Introduced in R2016a

feval

(Not recommended) Evaluate MuPAD expressions specifying their arguments

Note `feval(symengine,...)` is not recommended. Use equivalent Symbolic Math Toolbox™ functions that replace MuPAD® functions instead. For more information, see “Compatibility Considerations”.

Syntax

```
result = feval(symengine,F,x1,...,xn)
[result,status] = feval(symengine,F,x1,...,xn)
```

Description

`result = feval(symengine,F,x1,...,xn)` evaluates `F`, which is either a MuPAD function name or a symbolic object, with arguments `x1,...,xn`. Here, the returned value `result` is a symbolic object. If `F` with the arguments `x1,...,xn` throws an error in MuPAD, then this syntax throws an error in MATLAB.

`[result,status] = feval(symengine,F,x1,...,xn)` lets you catch errors thrown by MuPAD. This syntax returns the error status in `status`, and the error message in `result` if `status` is nonzero. If `status` is 0, `result` is a symbolic object. Otherwise, `result` is a character vector.

Examples

Perform MuPAD Command

```
syms a b c x
p = a*x^2+b*x+c;
feval(symengine,'polylib::discrim', p, x)
```

```
ans =
b^2 - 4*a*c
```

Alternatively, the same calculation based on variables not defined in the MATLAB workspace is:

```
feval(symengine,'polylib::discrim', 'a*x^2 + b*x + c', 'x')
```

```
ans =
b^2 - 4*a*c
```

Input Arguments

F — Input

MuPAD function name | symbolic object

Input specified as a MuPAD function name or symbolic object.

x_1, \dots, x_n — Arguments

symbolic expression

Arguments specified as symbolic expressions.

Output Arguments**result — Computation result**

character vector | symbolic object

Computation result returned as a symbolic object or character vector containing a MuPAD error message.

status — Error status

integer

Error status returned as an integer. If F with the arguments x_1, \dots, x_n executes without errors, the error status is 0.

Tips

- Results returned by `feval` can differ from the results that you get using a MuPAD notebook directly. The reason is that `feval` sets a lower level of evaluation to achieve better performance.
- `feval` does not open a MuPAD notebook, and therefore, you cannot use this function to access MuPAD graphics capabilities.

Compatibility Considerations**`feval(symengine, ...)` is not recommended***Not recommended starting in R2018b*

Symbolic Math Toolbox includes operations and functions for symbolic math expressions that parallel MATLAB functionality for numeric values. Unlike MuPAD functionality, Symbolic Math Toolbox functions enable you to work in familiar interfaces, such as the MATLAB Command Window or Live Editor, which offer a smooth workflow and are optimized for usability.

Therefore, instead of passing MuPAD expressions to `feval`, use the equivalent Symbolic Math Toolbox functionality to work with symbolic math expressions. For a list of available functions, see [Symbolic Math Toolbox functions list](#).

To convert a MuPAD notebook file to a MATLAB live script file, see `convertMuPADNotebook`.

If you cannot find the Symbolic Math Toolbox equivalent for MuPAD functionality, contact MathWorks Technical Support.

Although the use of `feval` is not recommended, there are no plans to remove it at this time.

Introduced in R2008b

fibonacci

Fibonacci numbers

Syntax

```
fibonacci(n)
```

Description

`fibonacci(n)` returns the n^{th} “Fibonacci Number” on page 4-488.

Examples

Find Fibonacci Numbers

Find the sixth Fibonacci number by using `fibonacci`.

```
fibonacci(6)
```

```
ans =  
      8
```

Find the first 10 Fibonacci numbers.

```
n = 1:10;  
fibonacci(n)
```

```
ans =  
      1      1      2      3      5      8     13     21     34     55
```

Fibonacci Sequence Approximates Golden Ratio

The ratio of successive Fibonacci numbers converges to the golden ratio 1.61803... Show this convergence by plotting this ratio against the golden ratio for the first 10 Fibonacci numbers.

```
n = 2:10;  
ratio = fibonacci(n)./fibonacci(n-1);
```

```
plot(n,ratio,'--o')  
hold on
```

```
line(xlim,[1.618 1.618])  
hold off
```

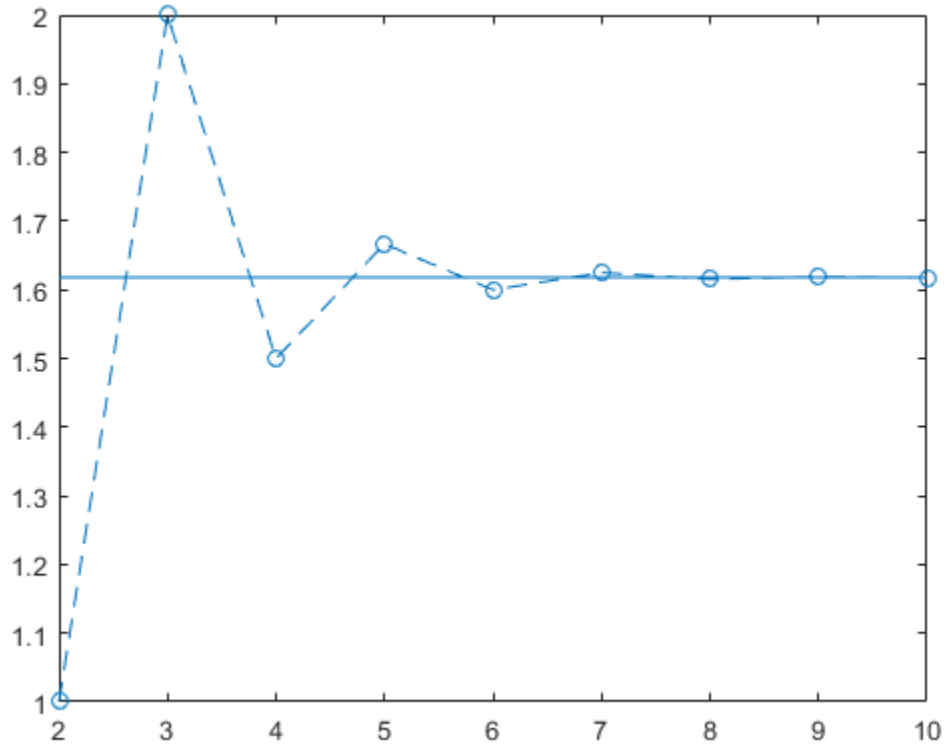

Symbolically Represent Fibonacci Numbers

Use Fibonacci numbers in symbolic calculations by representing them with symbolic input. `fibonacci` returns the input.

Represent the n^{th} Fibonacci number.

```
syms n
fibonacci(n)
```

```
ans =
fibonacci(n)
```

Find Large Fibonacci Numbers

Find large Fibonacci numbers by specifying the input symbolically using `sym`. Symbolic input returns exact symbolic output instead of double output. Convert symbolic numbers to double by using the `double` function.

Find the 300th Fibonacci number.

```
num = sym(300);
fib300 = fibonacci(num)
```

```
fib300 =
22232244629420445529739893461909967206666939096499764990979600
```

Convert `fib300` to double. The result is a floating-point approximation.

```
double(fib300)

ans =
    2.2223e+62
```

For more information on symbolic and double arithmetic, see “Choose Numeric or Symbolic Arithmetic” on page 2-124.

Golden Spiral Using Fibonacci Numbers

The Fibonacci numbers are commonly visualized by plotting the Fibonacci spiral. The Fibonacci spiral approximates the golden spiral.

Approximate the golden spiral for the first 8 Fibonacci numbers. Define the four cases for the right, top, left, and bottom squares in the plot by using a `switch` statement. Form the spiral by defining the equations of arcs through the squares in `eqnArc`. Draw the squares and arcs by using `rectangle` and `fimplicit` respectively.

```
x = 0;
y = 1;
syms v u

axis off
hold on

for n = 1:8

    a = fibonacci(n);

    % Define squares and arcs
    switch mod(n,4)
        case 0
            y = y - fibonacci(n-2);
            x = x - a;
            eqnArc = (u-(x+a))^2 + (v-y)^2 == a^2;
        case 1
            y = y - a;
            eqnArc = (u-(x+a))^2 + (v-(y+a))^2 == a^2;
        case 2
            x = x + fibonacci(n-1);
            eqnArc = (u-x)^2 + (v-(y+a))^2 == a^2;
        case 3
            x = x - fibonacci(n-2);
            y = y + fibonacci(n-1);
            eqnArc = (u-x)^2 + (v-y)^2 == a^2;
    end

    % Draw square
    pos = [x y a a];
    rectangle('Position', pos)

    % Add Fibonacci number
    xText = (x+x+a)/2;
    yText = (y+y+a)/2;
    text(xText, yText, num2str(a))
```

```

% Draw arc
interval = [x x+a y y+a];
fimplicit(eqnArc, interval, 'b')

```

```
end
```

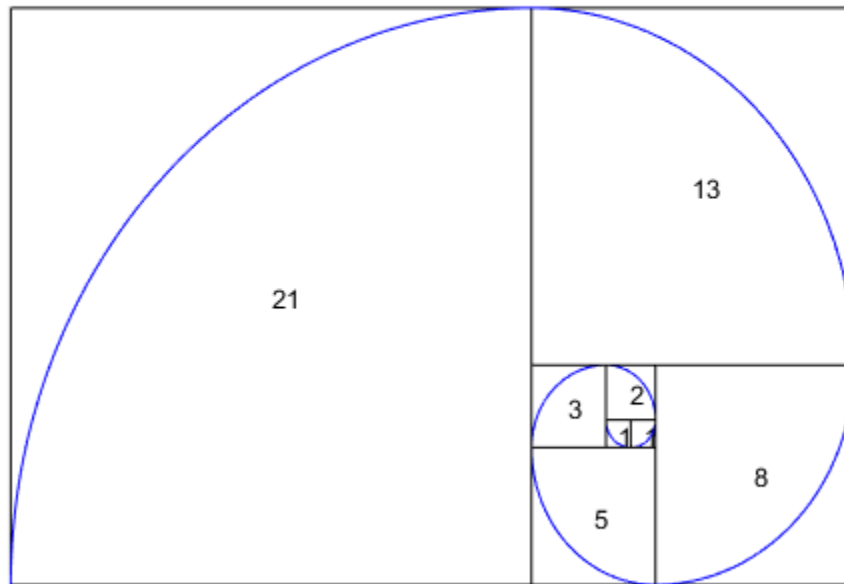

Input Arguments

n – Input

number | vector | matrix | multidimensional array | symbolic number | symbolic variable | symbolic vector | symbolic matrix | symbolic multidimensional array | symbolic function | symbolic expression

Input, specified as a number, vector, matrix or multidimensional array, or a symbolic number, variable, vector, matrix, multidimensional array, function, or expression.

More About

Fibonacci Number

The Fibonacci numbers are the sequence 0, 1, 1, 2, 3, 5, 8, 13, 21....

Given that the first two numbers are 0 and 1, the n^{th} Fibonacci number is

$$F_n = F_{n-1} + F_{n-2}.$$

Applying this formula repeatedly generates the Fibonacci numbers.

Introduced in R2017a

fimplicit

Plot implicit symbolic equation or function

Syntax

```
fimplicit(f)
fimplicit(f,[min max])
fimplicit(f,[xmin xmax ymin ymax])
```

```
fimplicit( ___,LineStyle)
fimplicit( ___,Name,Value)
fimplicit(ax, ___)
fi = fimPLICIT( ___)
```

Description

`fimplicit(f)` plots the implicit symbolic equation or function `f` over the default interval `[-5 5]` for `x` and `y`.

`fimplicit(f,[min max])` plots `f` over the interval `min < x < max` and `min < y < max`.

`fimplicit(f,[xmin xmax ymin ymax])` plots `f` over the interval `xmin < x < xmax` and `ymin < y < ymax`. The `fimplicit` function uses `symvar` to order the variables and assign intervals.

`fimplicit(___,LineStyle)` uses `LineStyle` to set the line style, marker symbol, and line color.

`fimplicit(___,Name,Value)` specifies line properties using one or more `Name,Value` pair arguments. Use this option with any of the input argument combinations in the previous syntaxes. `Name,Value` pair settings apply to all the lines plotted. To set options for individual lines, use the objects returned by `fimplicit`.

`fimplicit(ax, ___)` plots into the axes specified by `ax` instead of the current axes `gca`.

`fi = fimPLICIT(___)` returns an implicit function line object. Use the object to query and modify properties of a specific line. For details, see [Implicit Function Line](#).

Examples

Plot Implicit Symbolic Equation

Plot the hyperbola $x^2 - y^2 = 1$ by using `fimplicit`. The `fimplicit` function uses the default interval of `[-5,5]` for `x` and `y`.

```
syms x y
fimplicit(x^2 - y^2 == 1)
```

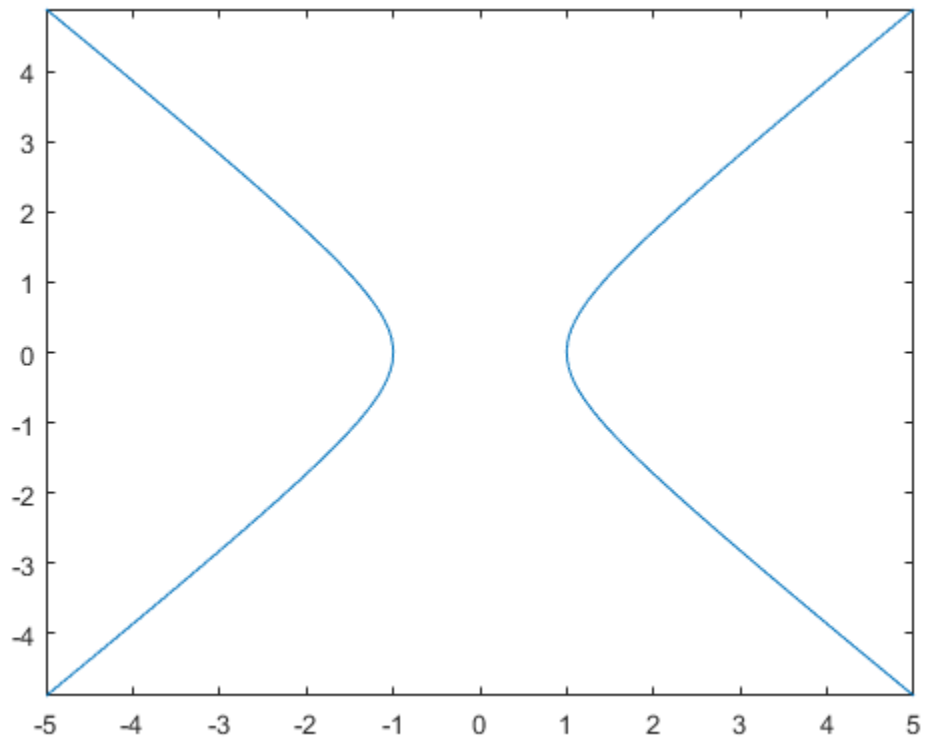
Plot Implicit Symbolic Function

Plot the hyperbola described by the function $f(x, y) = x^2 - y^2 - 1$ by first declaring the symbolic function $f(x, y)$ using `syms`. The `fimplicit` function uses the default interval of $[-5, 5]$ for x and y .

```
syms f(x,y)
f(x,y) = x^2 - y^2 - 1;
fimplicit(f)
```

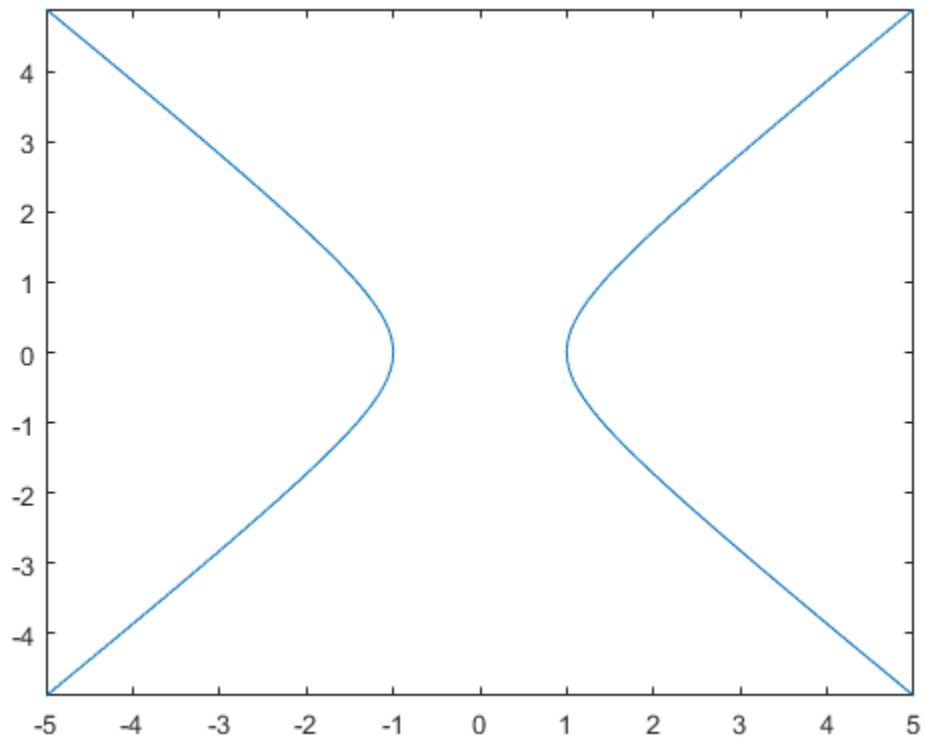

Specify Plotting Interval

Plot half of the circle $x^2 + y^2 = 3$ by using the intervals $-4 < x < 0$ and $-2 < y < 2$. Specify the plotting interval as the second argument of `fimplicit`.

```
syms x y
circle = x^2 + y^2 == 3;
fimplicit(circle, [-4 0 -2 2])
```

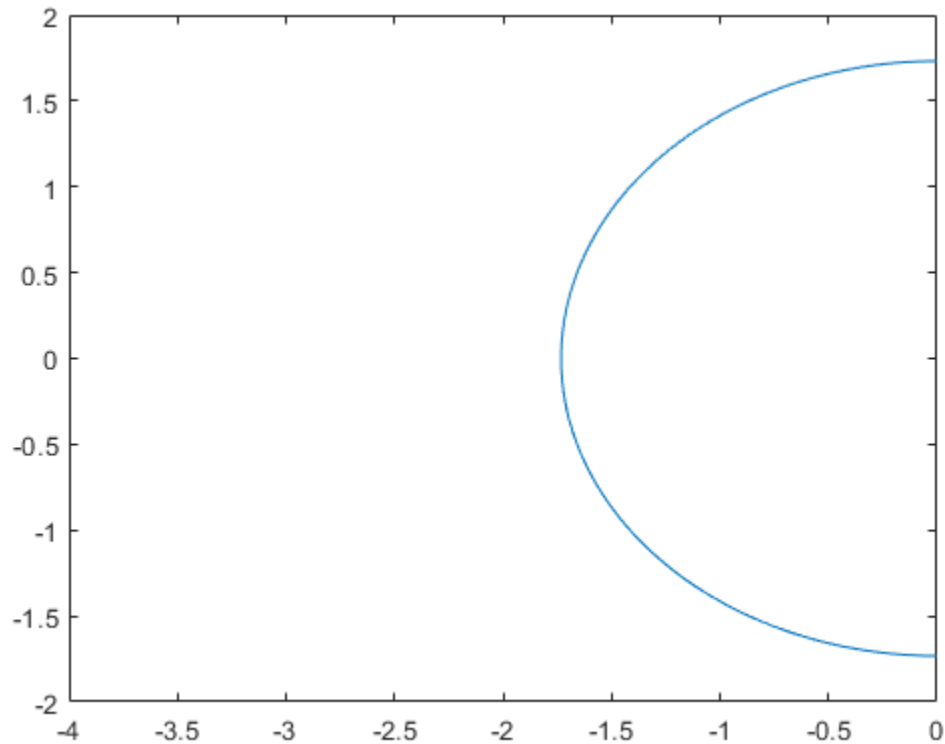

Plot Multiple Implicit Equations

You can plot multiple equations either by passing the inputs as a vector or by using `hold on` to successively plot on the same figure. If you specify `LineStyle` and Name-Value arguments, they apply to all lines. To set options for individual plots, use the function handles returned by `fimplicit`.

Divide a figure into two subplots by using `subplot`. On the first subplot, plot $x^2 + y^2 = 1$ and $x^2 + y^2 = 3$ using vector input. On the second subplot, plot the same inputs by using `hold on`.

```
syms x y
circle1 = x^2 + y^2 == 1;
circle2 = x^2 + y^2 == 3;

subplot(2,1,1)
fimplicit([circle1 circle2])
title('Multiple Equations Using Vector Input')

subplot(2,1,2)
fimplicit(circle1)
hold on
fimplicit(circle2)
title('Multiple Equations Using hold on Command')

hold off
```

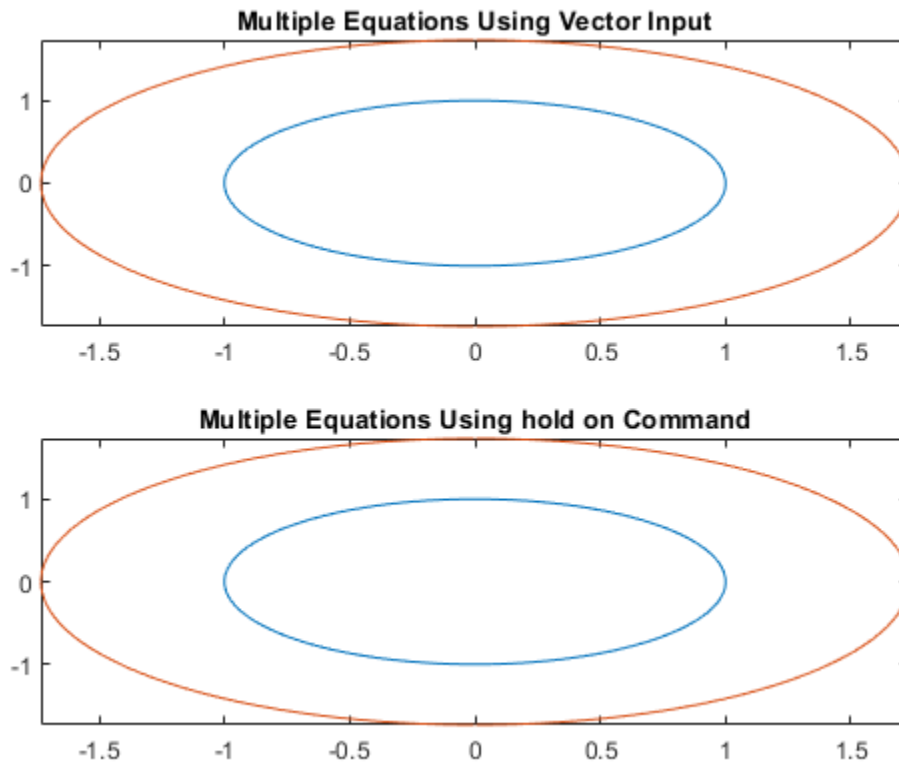

Change Line Properties and Display Markers

Plot three concentric circles of increasing diameter. For the first line, use a linewidth of 2. For the second, specify a dashed red line style with circle markers. For the third, specify a cyan, dash-dot line style with asterisk markers. Display the legend.

```
syms x y
circle = x^2 + y^2;
fimplicit(circle == 1, 'Linewidth', 2)
hold on
fimplicit(circle == 2, '--or')
fimplicit(circle == 3, '-.*c')
legend('show', 'Location', 'best')
hold off
```

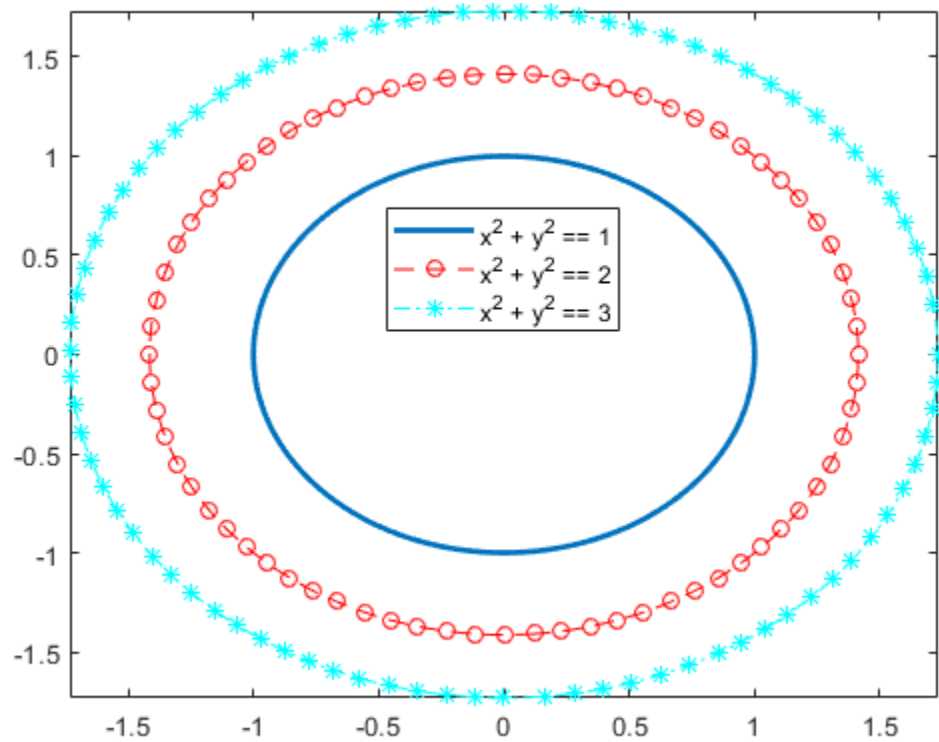

Modify Implicit Plot After Creation

Plot $y\sin(x) + x\cos(y) = 1$. Specify an output to make `fimplicit` return the plot object.

```
syms x y
eqn = y*sin(x) + x*cos(y) == 1;
fi = fimplicit(eqn)
```

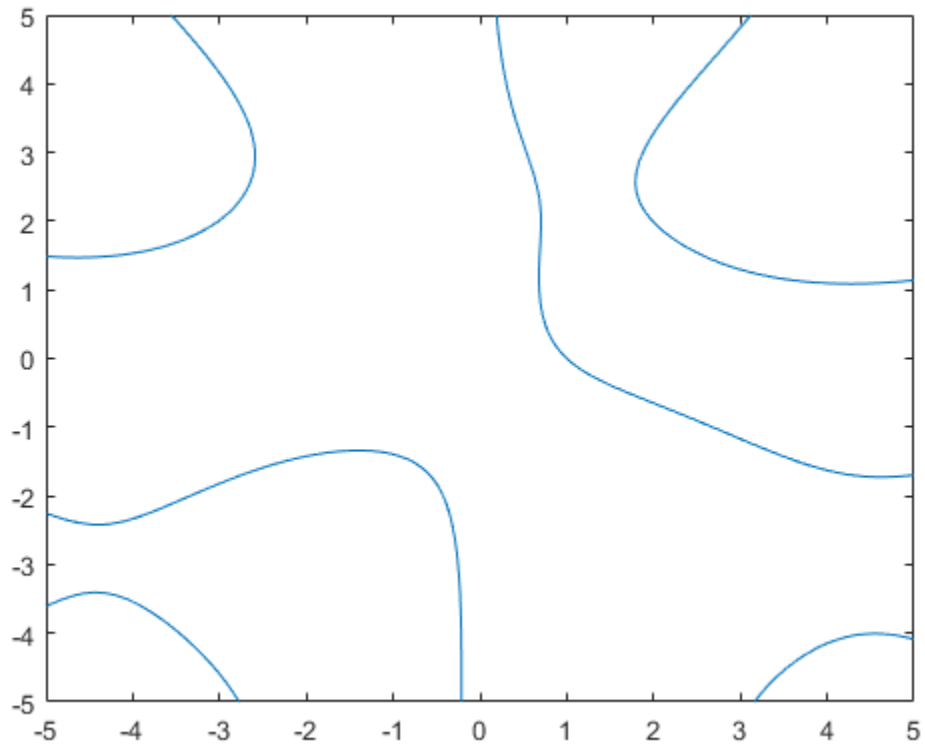

```
fi =
  ImplicitFunctionLine with properties:

    Function: [1x1 sym]
    Color: [0 0.4470 0.7410]
    LineStyle: '-'
    LineWidth: 0.5000

  Show all properties
```

Change the plotted equation to $x\cos(y) + y\sin(x) = 0$ by using dot notation to set properties. Similarly, change the line color to red and line style to a dash-dot line. The horizontal and vertical lines in the output are artifacts that should be ignored.

```
fi.Function = x/cos(y) + y/sin(x) == 0;
fi.Color = 'r';
fi.LineStyle = '-.';
```

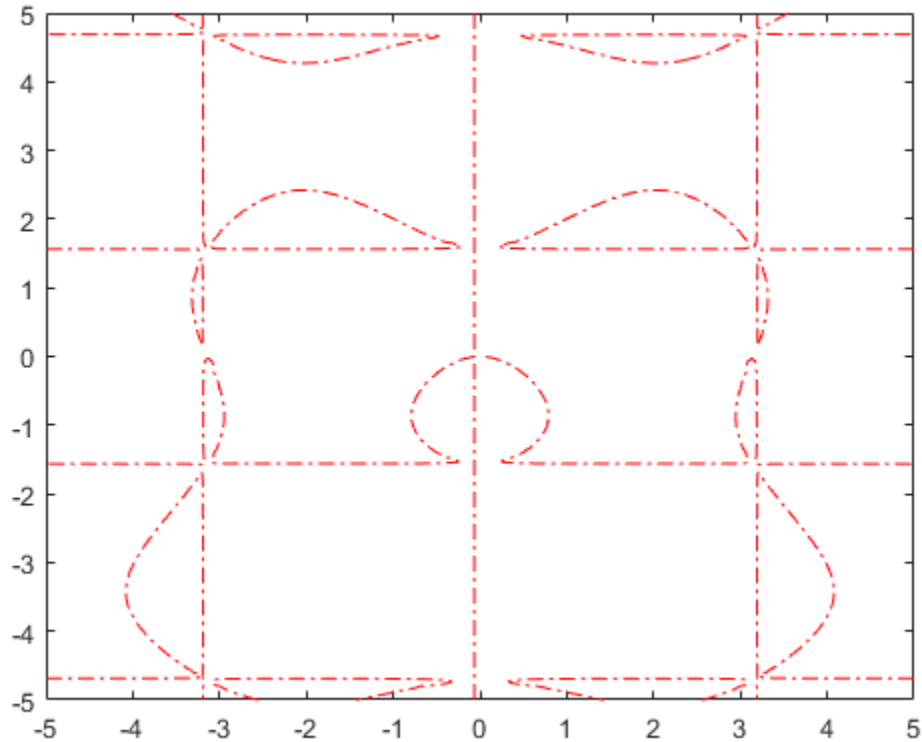

Add Title and Axis Labels and Format Ticks

Plot $x\cos(y) + y\sin(x) = 1$ over the interval $-2\pi < x < 2\pi$ and $-2\pi < y < 2\pi$. Add a title and axis labels. Create the x-axis ticks by spanning the x-axis limits at intervals of $\pi/2$. Display these ticks by using the `XTick` property. Create x-axis labels by using `arrayfun` to apply `textlabel` to `S`. Display these labels by using the `XTickLabel` property. Repeat these steps for the y-axis.

To use LaTeX in plots, see `latex`.

```
syms x y
eqn = x*cos(y) + y*sin(x) == 1;
fimplicit(eqn, [-2*pi 2*pi])
grid on
title('x cos(y) + y sin(x) for -2\pi < x < 2\pi and -2\pi < y < 2\pi')
xlabel('x')
ylabel('y')
ax = gca;

S = sym(ax.XLim(1):pi/2:ax.XLim(2));
ax.XTick = double(S);
ax.XTickLabel = arrayfun(@textlabel, S, 'UniformOutput', false);

S = sym(ax.YLim(1):pi/2:ax.YLim(2));
ax.YTick = double(S);
ax.YTickLabel = arrayfun(@textlabel, S, 'UniformOutput', false);
```

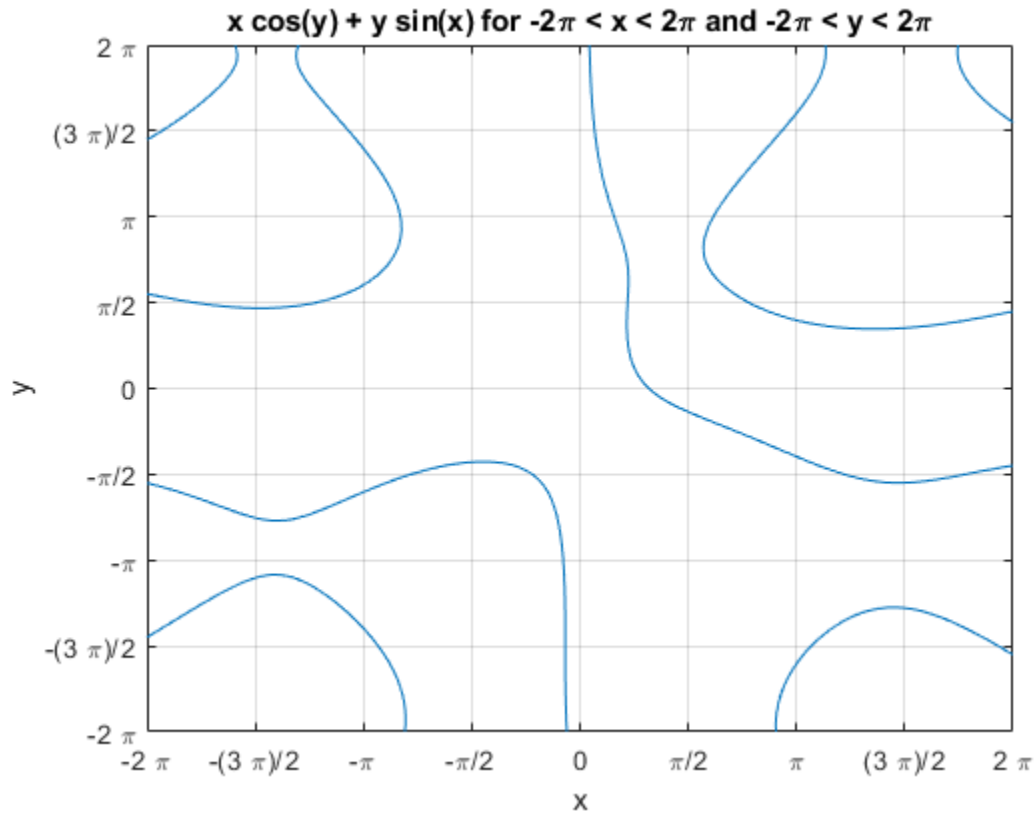

Re-evaluation on Zoom

When you zoom into a plot, `fimplicit` re-evaluates the plot automatically. This re-evaluation on zoom can reveal hidden detail at smaller scales.

Divide a figure into two by using `subplot`. Plot $x\cos(y) + y\sin(1/x) = 0$ in both the first and second subplots. Zoom into the second subplot by using `zoom`. The zoomed subplot shows detail that is not visible in the first subplot.

```
syms x y
eqn = x*cos(y) + y*sin(1/x) == 0;

subplot(2,1,1)
fimplicit(eqn)

subplot(2,1,2)
fimplicit(eqn)
zoom(2)
```

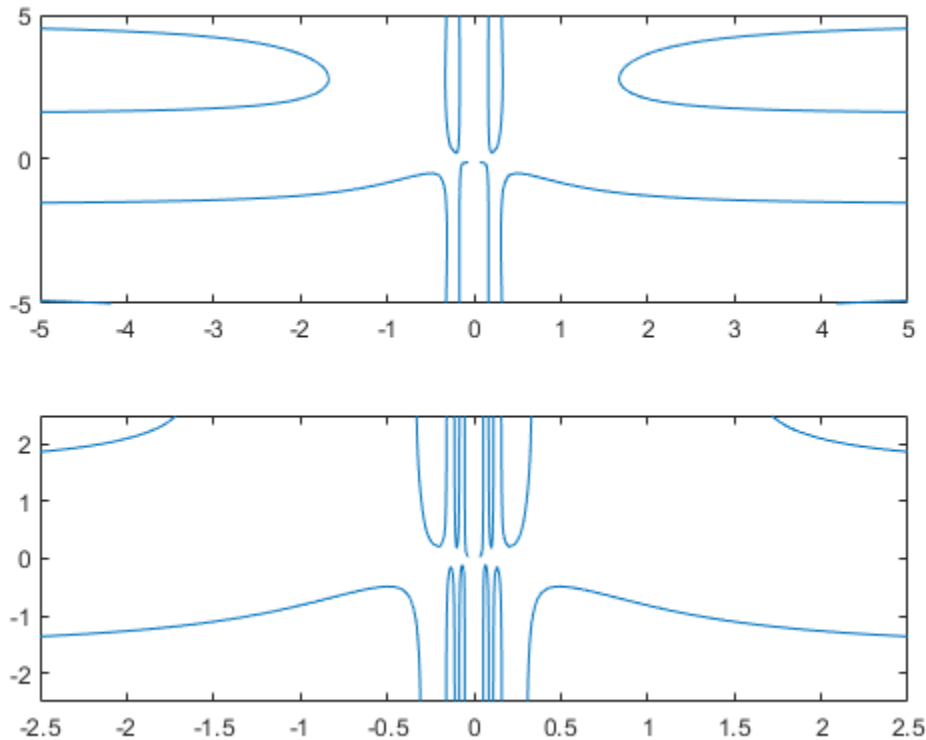
Input Arguments

f — Implicit equation or function to plot

symbolic equation | symbolic expression | symbolic function

Implicit equation or function to plot, specified as a symbolic equation, expression, or function. If the right-hand side is not specified, then it is assumed to be 0.

[min max] — Plotting range for x and y

[-5 5] (default) | vector of two numbers

Plotting range for x and y, specified as a vector of two numbers. The default range is [-5 5].

[xmin xmax ymin ymax] — Plotting range for x and y

[-5 5 -5 5] (default) | vector of four numbers

Plotting range for x and y, specified as a vector of four numbers. The default range is [-5 5 -5 5].

ax — Axes object

axes object

Axes object. If you do not specify an axes object, then `fimplicit` uses the current axes `gca`.

LineStyle — Line specification

character vector | string

Line specification, specified as a character vector or string with a line style, marker, and color. The elements can appear in any order, and you can omit one or more options. To show only markers with no connecting lines, specify a marker and omit the line style.

Example: 'r--o' specifies a red color, a dashed line, and circle markers

Line Style Specifier	Description
-	Solid line (default)
--	Dashed line
:	Dotted line
-. .	Dash-dot line

Marker Specifier	Description
o	Circle
+	Plus sign
*	Asterisk
.	Point
x	Cross
s	Square
d	Diamond
^	Upward-pointing triangle
v	Downward-pointing triangle
>	Right-pointing triangle
<	Left-pointing triangle
p	Pentagram
h	Hexagram

Color Specifier	Description
y	yellow
m	magenta
c	cyan
r	red
g	green
b	blue
w	white
k	black

Name-Value Pair Arguments

Specify optional comma-separated pairs of **Name**, **Value** arguments. **Name** is the argument name and **Value** is the corresponding value. **Name** must appear inside quotes. You can specify several name and value pair arguments in any order as **Name1, Value1, . . . , NameN, ValueN**.

The function line properties listed here are only a subset. For a complete list, see Implicit Function Line.

Example: 'Marker', 'o', 'MarkerFaceColor', 'red'

MeshDensity — Number of evaluation points per direction

151 (default) | number

Number of evaluation points per direction, specified as a number. The default is 151.

Color — Line color







[0 0.4470 0.7410] (default) | RGB triplet | hexadecimal color code | 'r' | 'g' | 'b' | ...

Line color, specified as an RGB triplet, a hexadecimal color code, a color name, or a short name.





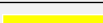

For a custom color, specify an RGB triplet or a hexadecimal color code.

- An RGB triplet is a three-element row vector whose elements specify the intensities of the red, green, and blue components of the color. The intensities must be in the range [0, 1]; for example, [0.4 0.6 0.7].
- A hexadecimal color code is a character vector or a string scalar that starts with a hash symbol (#) followed by three or six hexadecimal digits, which can range from 0 to F. The values are not case sensitive. Thus, the color codes '#FF8800', '#ff8800', '#F80', and '#f80' are equivalent.

Alternatively, you can specify some common colors by name. This table lists the named color options, the equivalent RGB triplets, and hexadecimal color codes.

Color Name	Short Name	RGB Triplet	Hexadecimal Color Code	Appearance
'red'	'r'	[1 0 0]	'#FF0000'	
'green'	'g'	[0 1 0]	'#00FF00'	
'blue'	'b'	[0 0 1]	'#0000FF'	
'cyan'	'c'	[0 1 1]	'#00FFFF'	
'magenta'	'm'	[1 0 1]	'#FF00FF'	
'yellow'	'y'	[1 1 0]	'#FFFF00'	
'black'	'k'	[0 0 0]	'#000000'	
'white'	'w'	[1 1 1]	'#FFFFFF'	

Here are the RGB triplets and hexadecimal color codes for the default colors MATLAB uses in many types of plots.

RGB Triplet	Hexadecimal Color Code	Appearance
[0 0.4470 0.7410]	'#0072BD'	
[0.8500 0.3250 0.0980]	'#D95319'	
[0.9290 0.6940 0.1250]	'#EDB120'	
[0.4940 0.1840 0.5560]	'#7E2F8E'	
[0.4660 0.6740 0.1880]	'#77AC30'	
[0.3010 0.7450 0.9330]	'#4DBEEE'	

RGB Triplet	Hexadecimal Color Code	Appearance
[0.6350 0.0780 0.1840]	'#A2142F'	

Example: 'blue'

Example: [0 0 1]

Example: '#0000FF'

LineStyle – Line style

'-' (default) | '--' | ':' | '-.' | 'none'

Line style, specified as one of the options listed in this table.

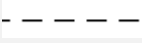
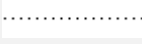
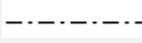
Line Style	Description	Resulting Line
'-'	Solid line	
'--'	Dashed line	
':'	Dotted line	
'-.'	Dash-dotted line	
'none'	No line	No line

LineWidth – Line width

0.5 (default) | positive value

Line width, specified as a positive value in points, where 1 point = 1/72 of an inch. If the line has markers, then the line width also affects the marker edges.

The line width cannot be thinner than the width of a pixel. If you set the line width to a value that is less than the width of a pixel on your system, the line displays as one pixel wide.

Marker – Marker symbol

'none' (default) | 'o' | '+' | '*' | '.' | 'x' | 's' | 'd' | ...

Marker symbol, specified as one of the values in this table. By default, a line does not have markers. Add markers at selected points along the line by specifying a marker.

Value	Description
'o'	Circle
'+'	Plus sign
'*'	Asterisk
'.'	Point
'x'	Cross
'square' or 's'	Square
'diamond' or 'd'	Diamond
'^'	Upward-pointing triangle

Value	Description
'v'	Downward-pointing triangle
'>'	Right-pointing triangle
'<'	Left-pointing triangle
'pentagram' or 'p'	Five-pointed star (pentagram)
'hexagram' or 'h'	Six-pointed star (hexagram)
'none'	No markers

MarkerEdgeColor — Marker outline color







'auto' (default) | RGB triplet | hexadecimal color code | 'r' | 'g' | 'b' | ...

Marker outline color, specified as 'auto', an RGB triplet, a hexadecimal color code, a color name, or a short name. The default value of 'auto' uses the same color as the Color property.



For a custom color, specify an RGB triplet or a hexadecimal color code.

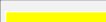



- An RGB triplet is a three-element row vector whose elements specify the intensities of the red, green, and blue components of the color. The intensities must be in the range $[0, 1]$; for example, $[0.4 \ 0.6 \ 0.7]$.
- A hexadecimal color code is a character vector or a string scalar that starts with a hash symbol (#) followed by three or six hexadecimal digits, which can range from 0 to F. The values are not case sensitive. Thus, the color codes '#FF8800', '#ff8800', '#F80', and '#f80' are equivalent.

Alternatively, you can specify some common colors by name. This table lists the named color options, the equivalent RGB triplets, and hexadecimal color codes.

Color Name	Short Name	RGB Triplet	Hexadecimal Color Code	Appearance
'red'	'r'	[1 0 0]	'#FF0000'	
'green'	'g'	[0 1 0]	'#00FF00'	
'blue'	'b'	[0 0 1]	'#0000FF'	
'cyan'	'c'	[0 1 1]	'#00FFFF'	
'magenta'	'm'	[1 0 1]	'#FF00FF'	
'yellow'	'y'	[1 1 0]	'#FFFF00'	
'black'	'k'	[0 0 0]	'#000000'	
'white'	'w'	[1 1 1]	'#FFFFFF'	
'none'	Not applicable	Not applicable	Not applicable	No color

Here are the RGB triplets and hexadecimal color codes for the default colors MATLAB uses in many types of plots.

RGB Triplet	Hexadecimal Color Code	Appearance
[0 0.4470 0.7410]	'#0072BD'	
[0.8500 0.3250 0.0980]	'#D95319'	

RGB Triplet	Hexadecimal Color Code	Appearance
[0.9290 0.6940 0.1250]	'#EDB120'	
[0.4940 0.1840 0.5560]	'#7E2F8E'	
[0.4660 0.6740 0.1880]	'#77AC30'	
[0.3010 0.7450 0.9330]	'#4DBEEE'	
[0.6350 0.0780 0.1840]	'#A2142F'	

MarkerFaceColor — Marker fill color







'none' (default) | 'auto' | RGB triplet | hexadecimal color code | 'r' | 'g' | 'b' | ...

Marker fill color, specified as 'auto', an RGB triplet, a hexadecimal color code, a color name, or a short name. The 'auto' value uses the same color as the MarkerEdgeColor property.

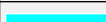

For a custom color, specify an RGB triplet or a hexadecimal color code.

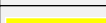



- An RGB triplet is a three-element row vector whose elements specify the intensities of the red, green, and blue components of the color. The intensities must be in the range [0, 1]; for example, [0.4 0.6 0.7].
- A hexadecimal color code is a character vector or a string scalar that starts with a hash symbol (#) followed by three or six hexadecimal digits, which can range from 0 to F. The values are not case sensitive. Thus, the color codes '#FF8800', '#ff8800', '#F80', and '#f80' are equivalent.

Alternatively, you can specify some common colors by name. This table lists the named color options, the equivalent RGB triplets, and hexadecimal color codes.

Color Name	Short Name	RGB Triplet	Hexadecimal Color Code	Appearance
'red'	'r'	[1 0 0]	'#FF0000'	
'green'	'g'	[0 1 0]	'#00FF00'	
'blue'	'b'	[0 0 1]	'#0000FF'	
'cyan'	'c'	[0 1 1]	'#00FFFF'	
'magenta'	'm'	[1 0 1]	'#FF00FF'	
'yellow'	'y'	[1 1 0]	'#FFFF00'	
'black'	'k'	[0 0 0]	'#000000'	
'white'	'w'	[1 1 1]	'#FFFFFF'	
'none'	Not applicable	Not applicable	Not applicable	No color

Here are the RGB triplets and hexadecimal color codes for the default colors MATLAB uses in many types of plots.

RGB Triplet	Hexadecimal Color Code	Appearance
[0 0.4470 0.7410]	'#0072BD'	
[0.8500 0.3250 0.0980]	'#D95319'	
[0.9290 0.6940 0.1250]	'#EDB120'	

RGB Triplet	Hexadecimal Color Code	Appearance
[0.4940 0.1840 0.5560]	'#7E2F8E'	
[0.4660 0.6740 0.1880]	'#77AC30'	
[0.3010 0.7450 0.9330]	'#4DBEEE'	
[0.6350 0.0780 0.1840]	'#A2142F'	

Example: [0.3 0.2 0.1]

Example: 'green'

Example: '#D2F9A7'

MarkerSize – Marker size

6 (default) | positive value

Marker size, specified as a positive value in points, where 1 point = 1/72 of an inch.

Output Arguments

fi – One or more implicit function line objects

scalar | vector

One or more implicit function line objects, returned as a scalar or a vector. You can use these objects to query and modify properties of a specific line. For a list of properties, see Implicit Function Line.

Algorithms

fimplicit assigns the symbolic variables in f to the x axis, then the y axis, and `symvar` determines the order of the variables to be assigned. Therefore, variable and axis names might not correspond. To force `fimplicit` to assign x or y to its corresponding axis, create the symbolic function to plot, then pass the symbolic function to `fimplicit`.

For example, the following code plots the roots of the implicit function $f(x,y) = \sin(y)$ in two ways. The first way forces the waves to oscillate with respect to the y axis. The second way assigns y to the x axis because it is the first (and only) variable in the symbolic function.

```
syms x y;
f(x,y) = sin(y);
intvl = [-6 6]*pi;

figure;
subplot(2,1,1)
fimplicit(f,intvl);
subplot(2,1,2)
fimplicit(f(x,y),intvl); % Or fimplicit(sin(y) == 0,intvl);
```

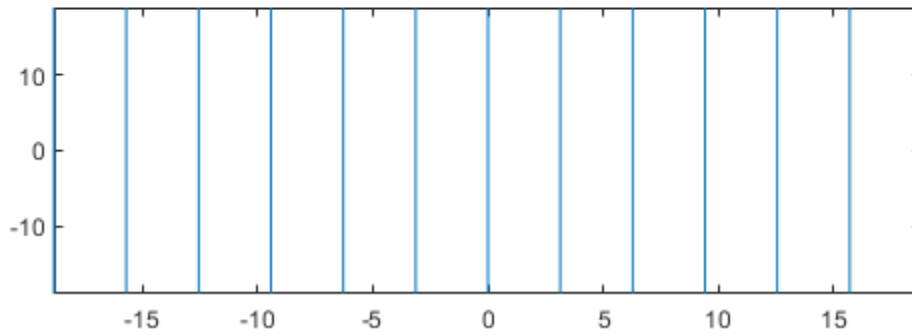
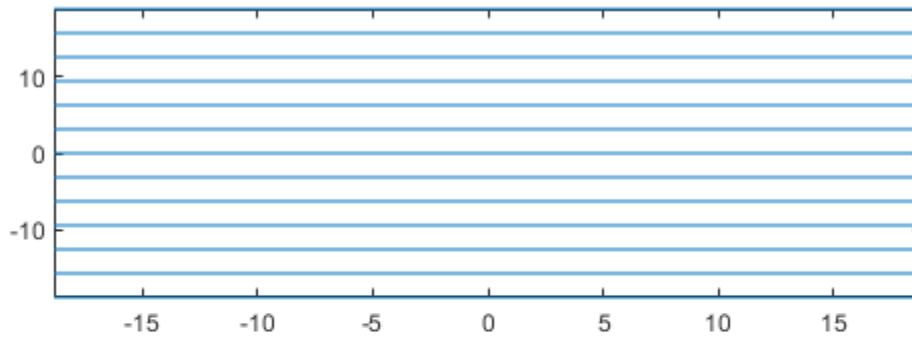

See Also

Functions

`fcontour` | `fimplicit3` | `fmesh` | `fplot` | `fplot3` | `fsurf`

Properties

Implicit Function Line

Topics

“Create Plots” on page 2-229

Introduced in R2016b

fimplicit3

Plot 3-D implicit equation or function

Syntax

```
fimplicit3(f)
fimplicit3(f,[min max])
fimplicit3(f,[xmin xmax ymin ymax zmin zmax])

fimplicit3(___,LineStyle)
fimplicit3(___,Name,Value)
fimplicit3(ax,___)
fi = fimplicit3(___)
```

Description

`fimplicit3(f)` plots the 3-D implicit equation or function $f(x,y,z)$ over the default interval $[-5, 5]$ for x , y , and z .

`fimplicit3(f,[min max])` plots $f(x,y,z)$ over the interval $[min\ max]$ for x , y , and z .

`fimplicit3(f,[xmin xmax ymin ymax zmin zmax])` plots $f(x,y,z)$ over the interval $[xmin\ xmax]$ for x , $[ymin\ ymax]$ for y , and $[zmin\ zmax]$ for z . The `fimplicit3` function uses `symvar` to order the variables and assign intervals.

`fimplicit3(___,LineStyle)` uses `LineStyle` to set the line style, marker symbol, and face color.

`fimplicit3(___,Name,Value)` specifies line properties using one or more `Name,Value` pair arguments. Use this option with any of the input argument combinations in the previous syntaxes.

`fimplicit3(ax,___)` plots into the axes with the object `ax` instead of the current axes object `gca`.

`fi = fimplicit3(___)` returns an implicit function surface object. Use the object to query and modify properties of a specific surface. For details, see [Implicit Function Surface](#).

Examples

Plot 3-D Implicit Symbolic Equation

Plot the hyperboloid $x^2 + y^2 - z^2 = 0$ by using `fimplicit3`. The `fimplicit3` function plots over the default interval of $[-5, 5]$ for x , y , and z .

```
syms x y z
fimplicit3(x^2 + y^2 - z^2)
```

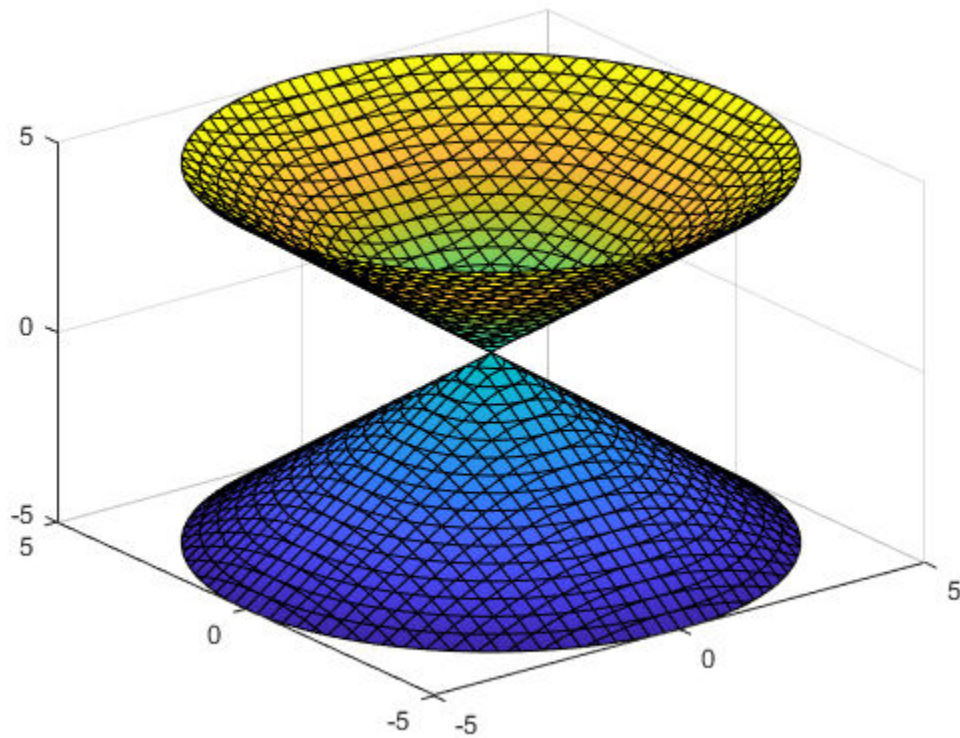

Plot 3-D Implicit Symbolic Function

Plot the hyperboloid specified by the function $f(x, y, z) = x^2 + y^2 - z^2$. The `fimplicit3` function plots over the default interval of $[-5, 5]$ for x , y , and z .

```
syms f(x,y,z)
f(x,y,z) = x^2 + y^2 - z^2;
fimplicit3(f)
```

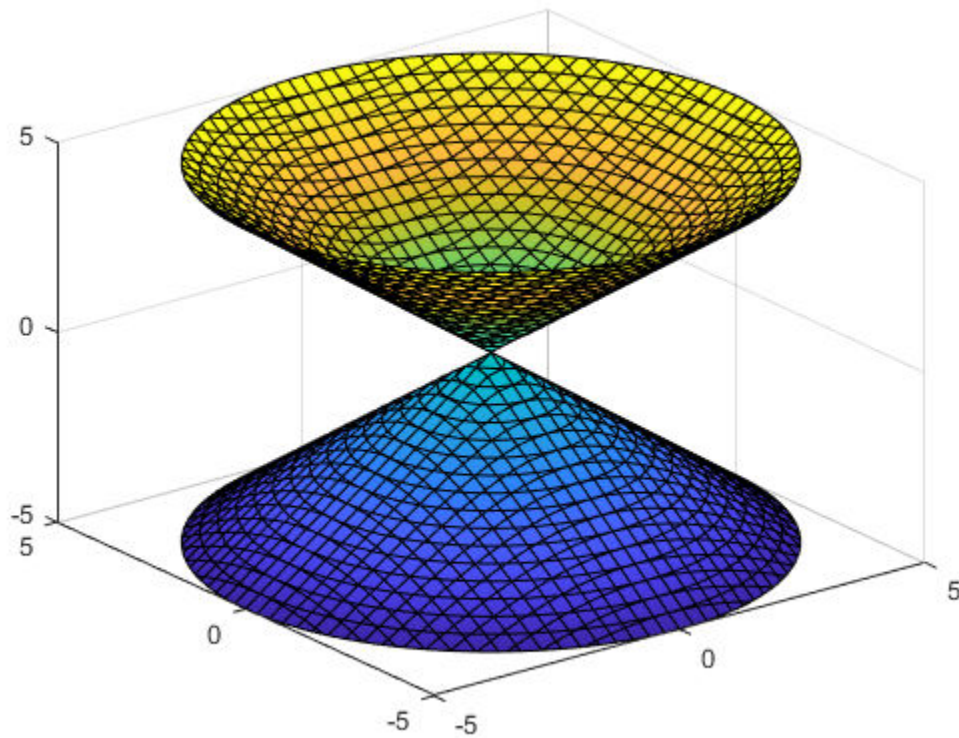

Specify Plotting Interval

Specify the plotting interval by specifying the second argument to `fimplicit3`. Plot the upper half of the hyperboloid $x^2 + y^2 - z^2 = 0$ by specifying the interval $0 < z < 5$. For x and y , use the default interval $[-5, 5]$.

```
syms x y z
f = x^2 + y^2 - z^2;
interval = [-5 5 -5 5 0 5];
fimplicit3(f, interval)
```

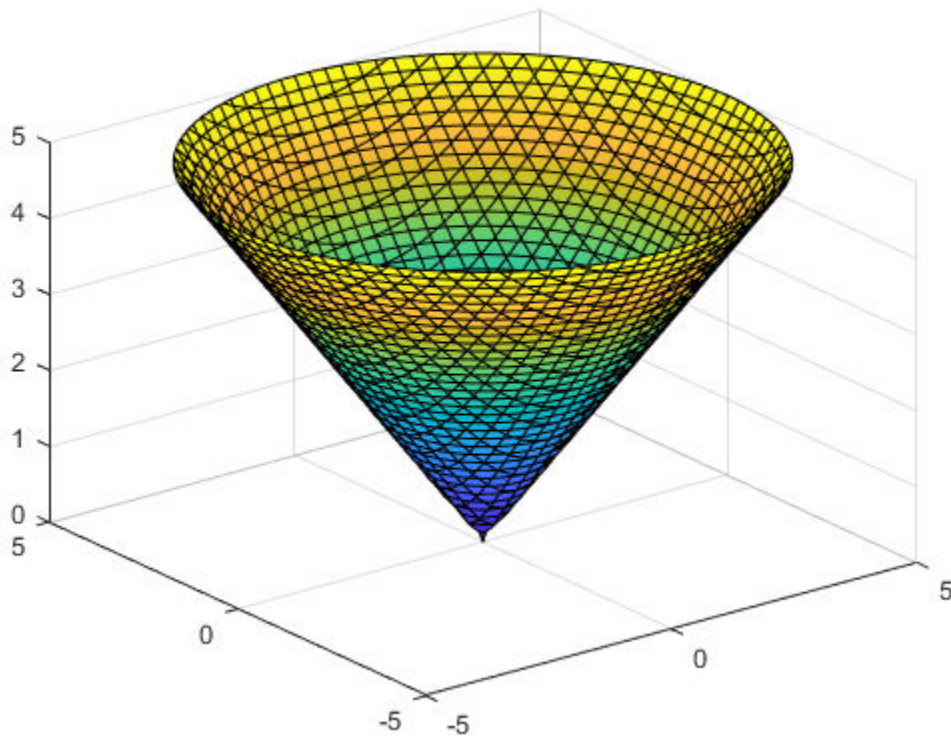

Add Title and Axis Labels and Format Ticks

Plot the implicit equation $x\sin(y) + z\cos(x) = 0$ over the interval $(-2\pi, 2\pi)$ for all axes.

Create the x-axis ticks by spanning the x-axis limits at intervals of $\pi/2$. Convert the axis limits to precise multiples of $\pi/2$ by using `round` and get the symbolic tick values in `S`. Display these ticks by using the `XTick` property. Create x-axis labels by using `arrayfun` to apply `texlabel` to `S`. Display these labels by using the `XTickLabel` property. Repeat these steps for the y-axis.

To use LaTeX in plots, see `latex`.

```
syms x y z
eqn = x*sin(y) + z*cos(x);
fimplicit3(eqn,[-2*pi 2*pi])
title('xsin(y) + zcos(x) for -2\pi < x < 2\pi and -2\pi < y < 2\pi')
xlabel('x')
ylabel('y')
ax = gca;

S = sym(ax.XLim(1):pi/2:ax.XLim(2));
S = sym(round(vpa(S/pi*2))*pi/2);
ax.XTick = double(S);
ax.XTickLabel = arrayfun(@texlabel,S,'UniformOutput',false);
```

```
S = sym(ax.YLim(1):pi/2:ax.YLim(2));
S = sym(round(vpa(S/pi*2))*pi/2);
ax.YTick = double(S);
ax.YTickLabel = arrayfun(@texlabel, S, 'UniformOutput', false);
```

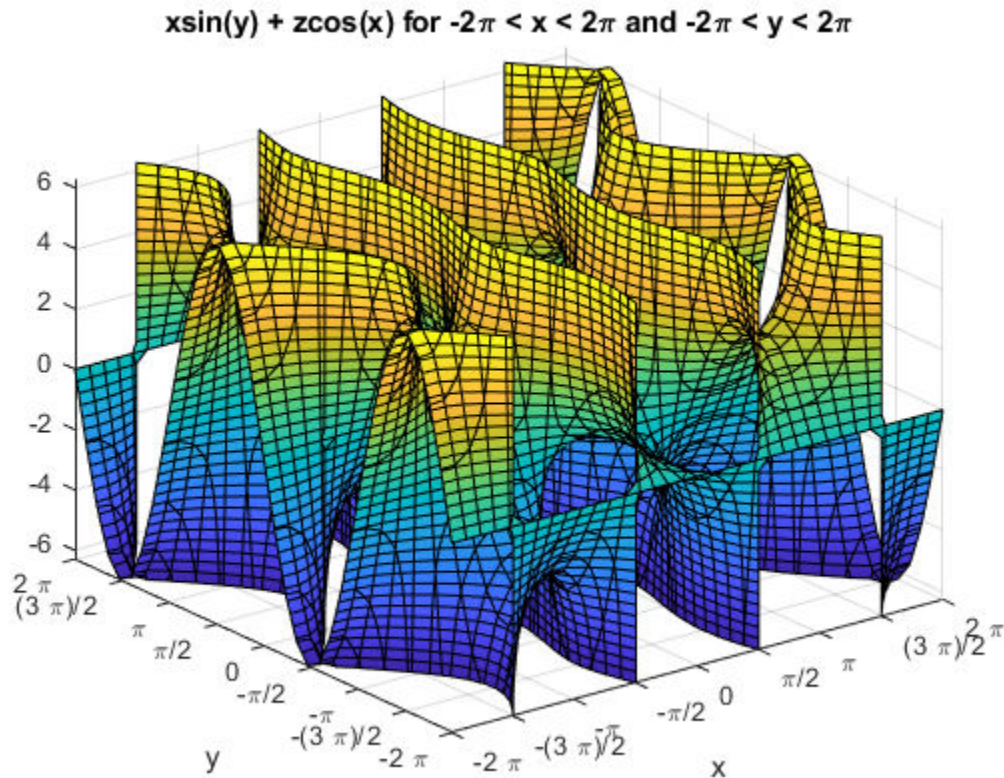

Line Style and Width for Implicit Surface Plot

Plot the implicit surface $x^2 + y^2 - z^2 = 0$ with different line styles for different values of z . For $-5 < z < -2$, use a dashed line with green dot markers. For $-2 < z < 2$, use a LineWidth of 1 and a green face color. For $2 < z < 5$, turn off the lines by setting EdgeColor to none.

```
syms x y z
f = x^2 + y^2 - z^2;
fimplicit3(f,[-5 5 -5 5 -5 -2], '--.', 'MarkerEdgeColor', 'g')
hold on
fimplicit3(f,[-5 5 -5 5 -2 2], 'LineWidth', 1, 'FaceColor', 'g')
fimplicit3(f,[-5 5 -5 5 2 5], 'EdgeColor', 'none')
```

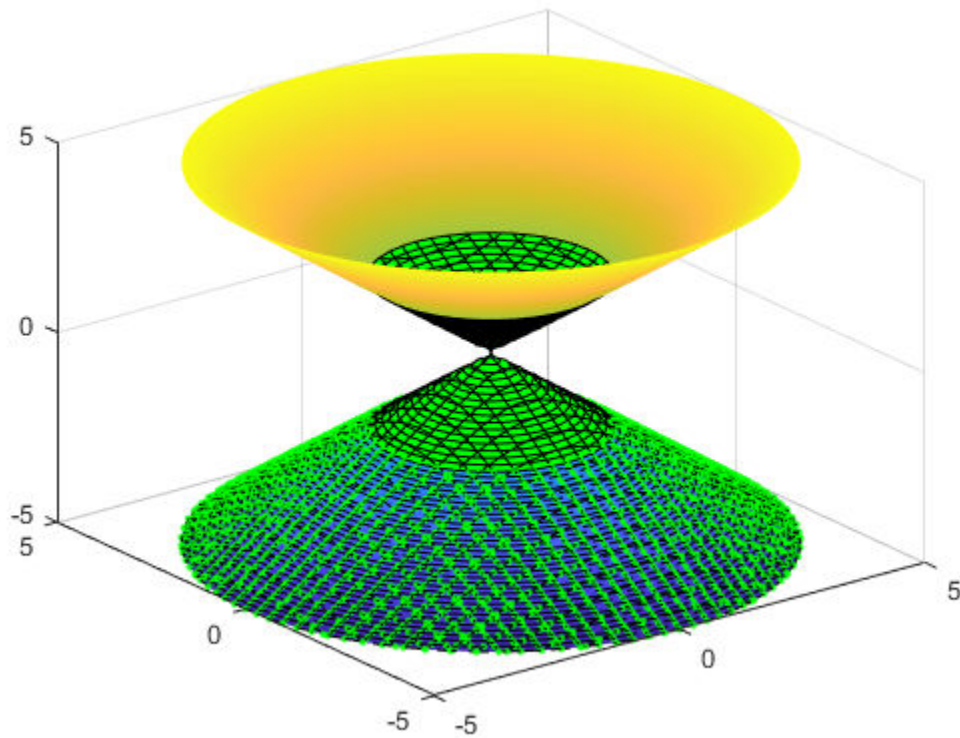

Modify Implicit Surface After Creation

Plot the implicit surface $1/x^2 - 1/y^2 + 1/z^2 = 0$. Specify an output to make `fimplicit3` return the plot object.

```
syms x y z
f = 1/x^2 - 1/y^2 + 1/z^2;
fi = fimplicit3(f)
```

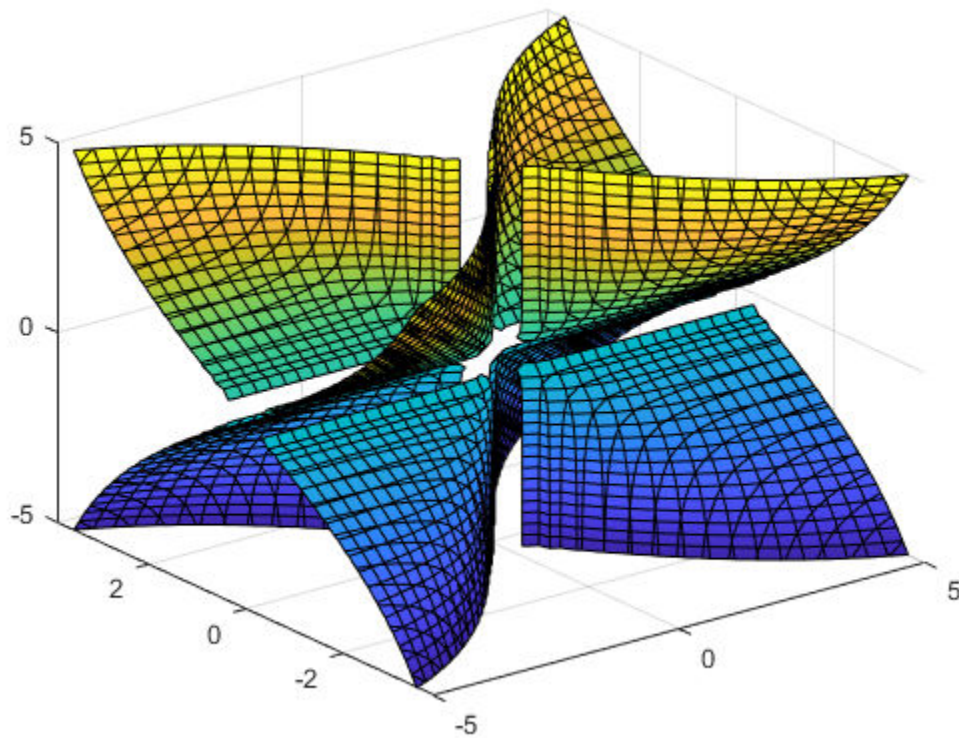

```
fi =  
  ImplicitFunctionSurface with properties:  
  
    Function: [1x1 sym]  
    EdgeColor: [0 0 0]  
    LineStyle: '-'  
    FaceColor: 'interp'  
  
  Show all properties
```

Show only the positive x-axis by setting the `XRange` property of `fi` to `[0 5]`. Remove the lines by setting the `EdgeColor` property to `'none'`. Visualize the hidden surfaces by making the plot transparent by setting the `FaceAlpha` property to `0.8`.

```
fi.XRange = [0 5];  
fi.EdgeColor = 'none';  
fi.FaceAlpha = 0.8;
```

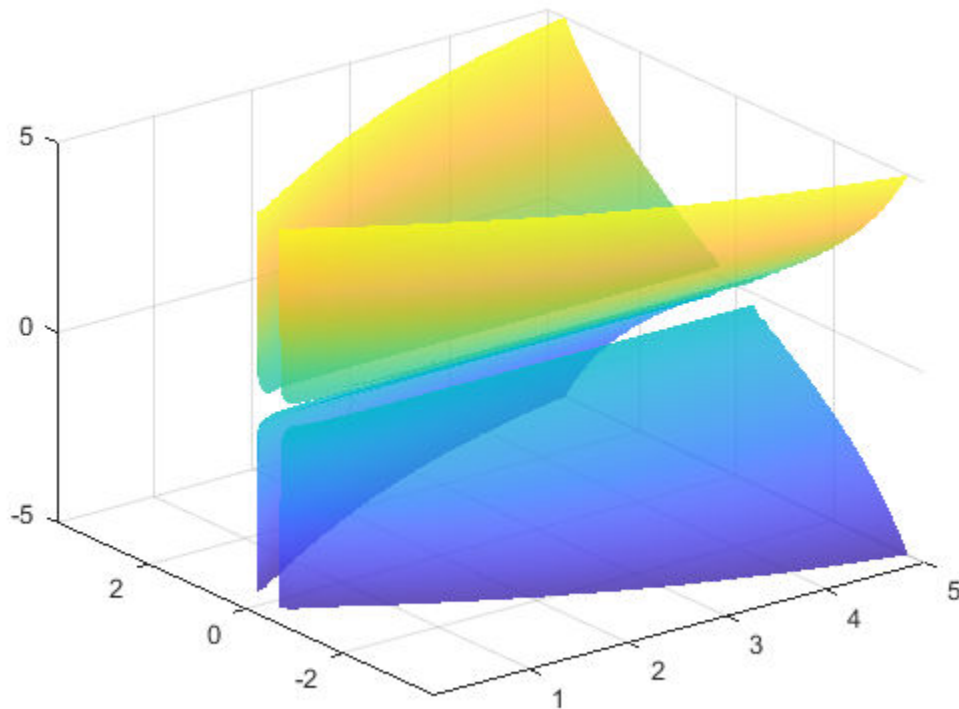

Control Resolution of Implicit Surface Plot

Control the resolution of an implicit surface plot by using the 'MeshDensity' option. Increasing 'MeshDensity' can make smoother, more accurate plots while decreasing 'MeshDensity' can increase plotting speed.

Divide a figure into two by using `subplot`. In the first subplot, plot the implicit surface $\sin(1/(xyz))$. The surface has large gaps. Fix this issue by increasing the 'MeshDensity' to 40 in the second subplot. `fimplicit3` fills the gaps showing that by increasing 'MeshDensity' you increased the resolution of the plot.

```
syms x y z
f = sin(1/(x*y*z));

subplot(2,1,1)
fimplicit3(f)
title('Default MeshDensity = 35')

subplot(2,1,2)
fimplicit3(f, 'MeshDensity', 40)
title('Increased MeshDensity = 40')
```

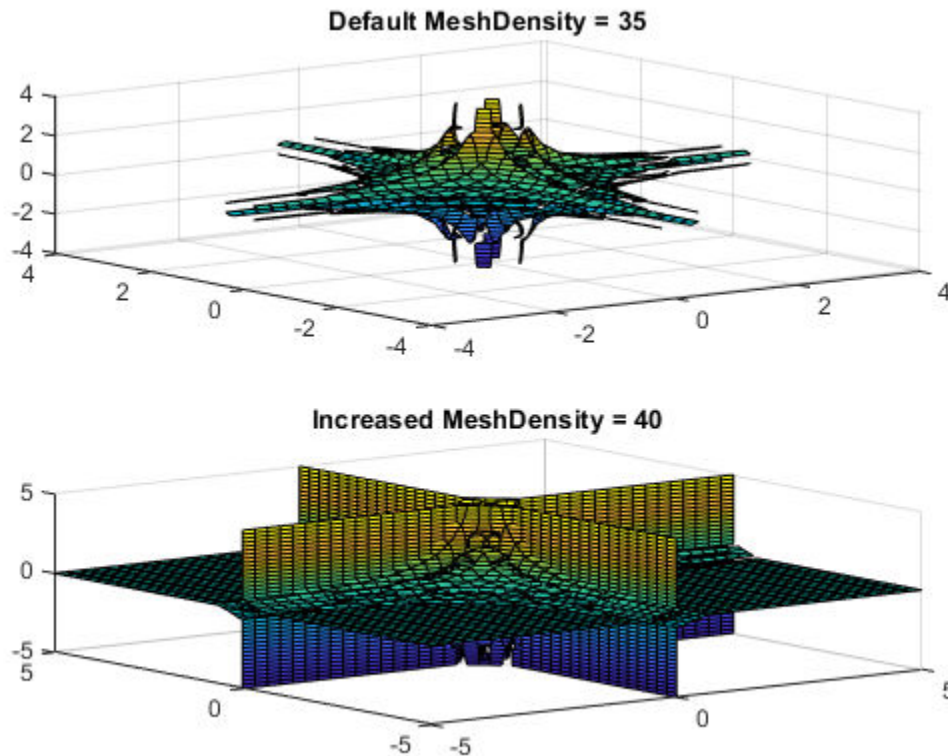
Apply Rotation and Translation to Implicit Surface Plot

Apply rotation and translation to the implicit surface plot of a torus.

A torus can be defined by an implicit equation in Cartesian coordinates as

$$f(x, y, z) = (x^2 + y^2 + z^2 + R^2 - a^2)^2 - 4R^2(x^2 + y^2)$$

where

- a is the radius of the tube
- R is the distance from the center of the tube to the center of the torus

Define the values for a and R as 1 and 5, respectively. Plot the torus using `fimplicit3`.

```
syms x y z
a = 1;
R = 4;
f(x,y,z) = (x^2+y^2+z^2+R^2-a^2)^2 - 4*R^2*(x^2+y^2);
fimplicit3(f)
hold on
```

Apply rotation to the torus around the x -axis. Define the rotation matrix. Rotate the torus by 90 degrees or $\pi/2$ radians. Shift the center of the torus by 5 along the x -axis.

```

alpha = pi/2;
Rx = [1 0 0;
      0 cos(alpha) sin(alpha);
      0 -sin(alpha) cos(alpha)];
r = [x; y; z];
r_90 = Rx*r;
g = subs(f,[x,y,z],[r_90(1)-5,r_90(2),r_90(3)]);

```

Add a second plot of the rotated and translated torus to the existing graph.

```

fimplicit3(g)
axis([-5 10 -5 10 -5 5])
hold off

```

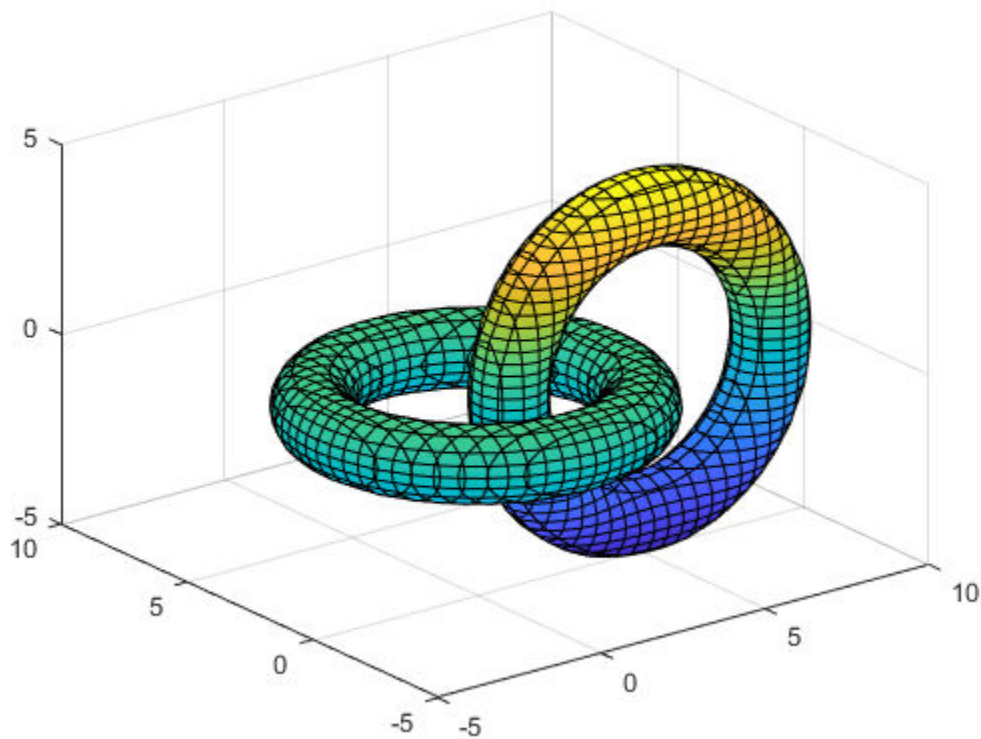

Input Arguments

f — 3-D implicit equation or function to plot

symbolic equation | symbolic expression | symbolic function

3-D implicit equation or function to plot, specified as a symbolic equation, expression, or function. If an expression or function is specified, then `fimplicit3` assumes the right-hand side to be 0.

[min max] — Plotting interval for x-, y- and z- axes

[-5 5] (default) | vector of two numbers

Plotting interval for x-, y- and z- axes, specified as a vector of two numbers. The default is [-5 5].

[xmin xmax ymin ymax zmin zmax] — Plotting interval for x-, y- and z- axes

[-5 5 -5 5 -5 5] (default) | vector of six numbers

Plotting interval for x-, y- and z- axes, specified as a vector of six numbers. The default is [-5 5 -5 5 -5 5].

ax — Axes object

axes object

Axes object. If you do not specify an axes object, then `fimplicit3` uses the current axes.

LineStyle — Line style, marker symbol, and face color

character vector

Line style, marker symbol, and face color, specified as a character vector. The elements of the character vector can appear in any order, and you can omit one or more options from the character vector specifier.

Example: `'--or'` is a red surface with circle markers and dashed lines

Specifier	Line Style
-	Solid line (default)
--	Dashed line
:	Dotted line
-. .	Dash-dot line

Specifier	Marker
o	Circle
+	Plus sign
*	Asterisk
.	Point
x	Cross
s	Square
d	Diamond
^	Upward-pointing triangle
v	Downward-pointing triangle
>	Right-pointing triangle
<	Left-pointing triangle
p	Pentagram
h	Hexagram

Specifier	Color
y	yellow
m	magenta
c	cyan

Specifier	Color
r	red
g	green
b	blue
w	white
k	black

Name-Value Pair Arguments

Specify optional comma-separated pairs of `Name`, `Value` arguments. `Name` is the argument name and `Value` is the corresponding value. `Name` must appear inside quotes. You can specify several name and value pair arguments in any order as `Name1, Value1, ..., NameN, ValueN`.

Example: `'Marker', 'o', 'MarkerFaceColor', 'red'`

The properties listed here are only a subset. For a complete list, see `Implicit Function Surface`.

MeshDensity — Number of evaluation points per direction

35 (default) | number

Number of evaluation points per direction, specified as a number. The default is 35.

Example: 100

EdgeColor — Line color





[0 0 0] (default) | 'interp' | RGB triplet | hexadecimal color code | 'r' | 'g' | 'b' | ...

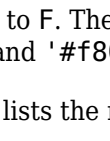

Line color, specified as `'interp'`, an RGB triplet, a hexadecimal color code, a color name, or a short name. The default RGB triplet value of [0 0 0] corresponds to black. The `'interp'` value colors the edges based on the `ZData` values.

For a custom color, specify an RGB triplet or a hexadecimal color code.

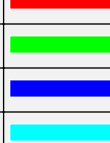
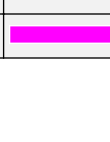



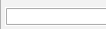

- An RGB triplet is a three-element row vector whose elements specify the intensities of the red, green, and blue components of the color. The intensities must be in the range [0, 1]; for example, [0.4 0.6 0.7].
- A hexadecimal color code is a character vector or a string scalar that starts with a hash symbol (#) followed by three or six hexadecimal digits, which can range from 0 to F. The values are not case sensitive. Thus, the color codes '#FF8800', '#ff8800', '#F80', and '#f80' are equivalent.

Alternatively, you can specify some common colors by name. This table lists the named color options, the equivalent RGB triplets, and hexadecimal color codes.

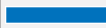
Color Name	Short Name	RGB Triplet	Hexadecimal Color Code	Appearance
'red'	'r'	[1 0 0]	'#FF0000'	
'green'	'g'	[0 1 0]	'#00FF00'	
'blue'	'b'	[0 0 1]	'#0000FF'	
'cyan'	'c'	[0 1 1]	'#00FFFF'	
'magenta'	'm'	[1 0 1]	'#FF00FF'	

Color Name	Short Name	RGB Triplet	Hexadecimal Color Code	Appearance
'yellow'	'y'	[1 1 0]	'#FFFF00'	
'black'	'k'	[0 0 0]	'#000000'	
'white'	'w'	[1 1 1]	'#FFFFFF'	
'none'	Not applicable	Not applicable	Not applicable	No color

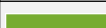

Here are the RGB triplets and hexadecimal color codes for the default colors MATLAB uses in many types of plots.

RGB Triplet	Hexadecimal Color Code	Appearance
[0 0.4470 0.7410]	'#0072BD'	
[0.8500 0.3250 0.0980]	'#D95319'	
[0.9290 0.6940 0.1250]	'#EDB120'	
[0.4940 0.1840 0.5560]	'#7E2F8E'	
[0.4660 0.6740 0.1880]	'#77AC30'	
[0.3010 0.7450 0.9330]	'#4DBEEE'	
[0.6350 0.0780 0.1840]	'#A2142F'	

LineStyle – Line style

'-' (default) | '--' | ':' | '-.' | 'none'

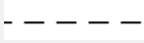
Line style, specified as one of the options listed in this table.

Line Style	Description	Resulting Line
'-'	Solid line	
'--'	Dashed line	
':'	Dotted line	
'-.'	Dash-dotted line	
'none'	No line	No line

LineWidth – Line width

0.5 (default) | positive value

Line width, specified as a positive value in points, where 1 point = 1/72 of an inch. If the line has markers, then the line width also affects the marker edges.

The line width cannot be thinner than the width of a pixel. If you set the line width to a value that is less than the width of a pixel on your system, the line displays as one pixel wide.

Marker – Marker symbol

'none' (default) | 'o' | '+' | '*' | '.' | 'x' | 's' | 'd' | ...

Marker symbol, specified as one of the values in this table. By default, a line does not have markers. Add markers at selected points along the line by specifying a marker.

Value	Description
'o'	Circle
'+'	Plus sign
'*'	Asterisk
'.'	Point
'x'	Cross
'square' or 's'	Square
'diamond' or 'd'	Diamond
'^'	Upward-pointing triangle
'v'	Downward-pointing triangle
'>'	Right-pointing triangle
'<'	Left-pointing triangle
'pentagram' or 'p'	Five-pointed star (pentagram)
'hexagram' or 'h'	Six-pointed star (hexagram)
'none'	No markers

MarkerEdgeColor — Marker outline color







'auto' (default) | RGB triplet | hexadecimal color code | 'r' | 'g' | 'b' | ...

Marker outline color, specified as 'auto', an RGB triplet, a hexadecimal color code, a color name, or a short name. The default value of 'auto' uses the same color as the EdgeColor property.

For a custom color, specify an RGB triplet or a hexadecimal color code.





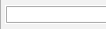

- An RGB triplet is a three-element row vector whose elements specify the intensities of the red, green, and blue components of the color. The intensities must be in the range [0, 1]; for example, [0.4 0.6 0.7].
- A hexadecimal color code is a character vector or a string scalar that starts with a hash symbol (#) followed by three or six hexadecimal digits, which can range from 0 to F. The values are not case sensitive. Thus, the color codes '#FF8800', '#ff8800', '#F80', and '#f80' are equivalent.

Alternatively, you can specify some common colors by name. This table lists the named color options, the equivalent RGB triplets, and hexadecimal color codes.

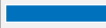
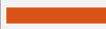
Color Name	Short Name	RGB Triplet	Hexadecimal Color Code	Appearance
'red'	'r'	[1 0 0]	'#FF0000'	
'green'	'g'	[0 1 0]	'#00FF00'	
'blue'	'b'	[0 0 1]	'#0000FF'	
'cyan'	'c'	[0 1 1]	'#00FFFF'	
'magenta'	'm'	[1 0 1]	'#FF00FF'	
'yellow'	'y'	[1 1 0]	'#FFFF00'	

Color Name	Short Name	RGB Triplet	Hexadecimal Color Code	Appearance
'black'	'k'	[0 0 0]	'#000000'	
'white'	'w'	[1 1 1]	'#FFFFFF'	
'none'	Not applicable	Not applicable	Not applicable	No color

Here are the RGB triplets and hexadecimal color codes for the default colors MATLAB uses in many types of plots.

RGB Triplet	Hexadecimal Color Code	Appearance
[0 0.4470 0.7410]	'#0072BD'	
[0.8500 0.3250 0.0980]	'#D95319'	
[0.9290 0.6940 0.1250]	'#EDB120'	
[0.4940 0.1840 0.5560]	'#7E2F8E'	
[0.4660 0.6740 0.1880]	'#77AC30'	
[0.3010 0.7450 0.9330]	'#4DBEEE'	
[0.6350 0.0780 0.1840]	'#A2142F'	

Example: [0.5 0.5 0.5]

Example: 'blue'

Example: '#D2F9A7'

MarkerFaceColor — Marker fill color



'none' (default) | 'auto' | RGB triplet | hexadecimal color code | 'r' | 'g' | 'b' | ...



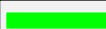

Marker fill color, specified as 'auto', an RGB triplet, a hexadecimal color code, a color name, or a short name. The 'auto' value uses the same color as the MarkerEdgeColor property.

For a custom color, specify an RGB triplet or a hexadecimal color code.







- An RGB triplet is a three-element row vector whose elements specify the intensities of the red, green, and blue components of the color. The intensities must be in the range [0, 1]; for example, [0.4 0.6 0.7].
- A hexadecimal color code is a character vector or a string scalar that starts with a hash symbol (#) followed by three or six hexadecimal digits, which can range from 0 to F. The values are not case sensitive. Thus, the color codes '#FF8800', '#ff8800', '#F80', and '#f80' are equivalent.

Alternatively, you can specify some common colors by name. This table lists the named color options, the equivalent RGB triplets, and hexadecimal color codes.

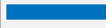
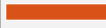
Color Name	Short Name	RGB Triplet	Hexadecimal Color Code	Appearance
'red'	'r'	[1 0 0]	'#FF0000'	
'green'	'g'	[0 1 0]	'#00FF00'	
'blue'	'b'	[0 0 1]	'#0000FF'	

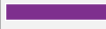
Color Name	Short Name	RGB Triplet	Hexadecimal Color Code	Appearance
'cyan'	'c'	[0 1 1]	'#00FFFF'	
'magenta'	'm'	[1 0 1]	'#FF00FF'	
'yellow'	'y'	[1 1 0]	'#FFFF00'	
'black'	'k'	[0 0 0]	'#000000'	
'white'	'w'	[1 1 1]	'#FFFFFF'	
'none'	Not applicable	Not applicable	Not applicable	No color

Here are the RGB triplets and hexadecimal color codes for the default colors MATLAB uses in many types of plots.

RGB Triplet	Hexadecimal Color Code	Appearance
[0 0.4470 0.7410]	'#0072BD'	
[0.8500 0.3250 0.0980]	'#D95319'	
[0.9290 0.6940 0.1250]	'#EDB120'	
[0.4940 0.1840 0.5560]	'#7E2F8E'	
[0.4660 0.6740 0.1880]	'#77AC30'	
[0.3010 0.7450 0.9330]	'#4DBEEE'	
[0.6350 0.0780 0.1840]	'#A2142F'	

Example: [0.3 0.2 0.1]

Example: 'green'

Example: '#D2F9A7'

MarkerSize — Marker size

6 (default) | positive value

Marker size, specified as a positive value in points, where 1 point = 1/72 of an inch.

Output Arguments

fi — One or more objects

scalar | vector

One or more objects, returned as a scalar or a vector. The object is an implicit function surface object. You can use these objects to query and modify properties of a specific line. For details, see Implicit Function Surface.

Algorithms

`fimplicit3` assigns the symbolic variables in `f` to the `x` axis, the `y` axis, then the `z` axis, and `symvar` determines the order of the variables to be assigned. Therefore, variable and axis names might not correspond. To force `fimplicit3` to assign `x`, `y`, or `z` to its corresponding axis, create the symbolic function to plot, then pass the symbolic function to `fimplicit3`.

For example, the following code plots the roots of the implicit function $f(x,y,z) = x + z$ in two ways. The first way forces `fimplicit3` to assign x and z to their corresponding axes. In the second way, `fimplicit3` defers to `symvar` to determine variable order and axis assignment: `fimplicit3` assigns x and z to the x and y axes, respectively.

```
syms x y z;
f(x,y,z) = x + z;

figure;
subplot(2,1,1)
fimplicit3(f);
view(-38,71);
subplot(2,1,2)
fimplicit3(f(x,y,z)); % Or fimplicit3(x + z);
```

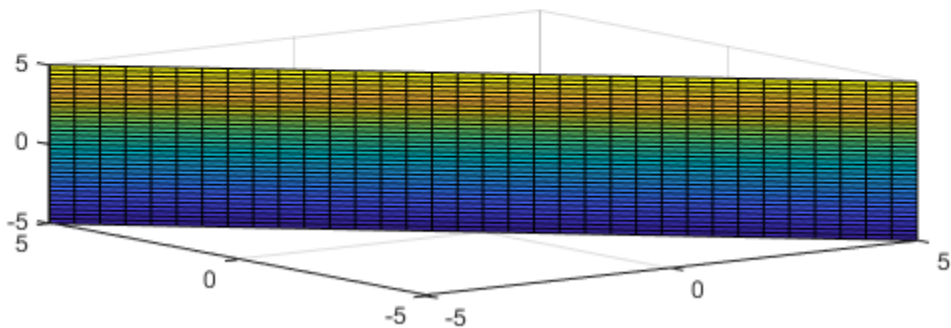
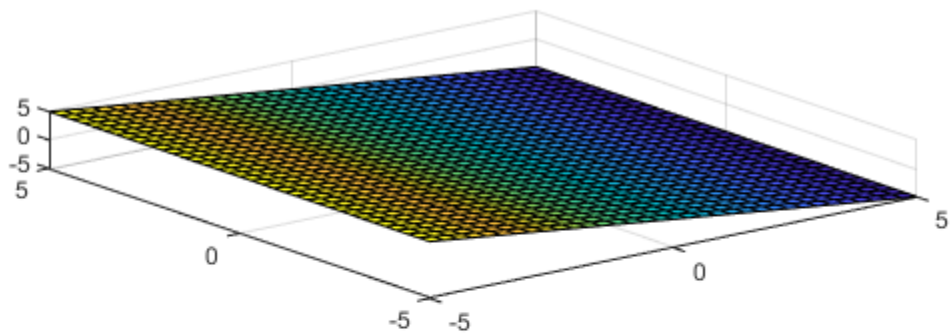

See Also

Functions

[fcontour](#) | [fimplicit](#) | [fmesh](#) | [fplot](#) | [fplot3](#) | [fsurf](#)

Properties

Implicit Function Surface

Topics

“Create Plots” on page 2-229

Introduced in R2016b

findDecoupledBlocks

Search for decoupled blocks in systems of equations

Syntax

```
[eqsBlocks, varsBlocks] = findDecoupledBlocks(eqs, vars)
```

Description

`[eqsBlocks, varsBlocks] = findDecoupledBlocks(eqs, vars)` identifies subsets (blocks) of equations that can be used to define subsets of variables. The number of variables `vars` must coincide with the number of equations `eqs`.

The i th block is the set of equations determining the variables in `vars(varsBlocks{i})`. The variables in `vars([varsBlocks{1}, ..., varsBlocks{i-1}])` are determined recursively by the previous blocks of equations. After you solve the first block of equations for the first block of variables, the second block of equations, given by `eqs(eqsBlocks{2})`, defines a decoupled subset of equations containing only the subset of variables given by the second block of variables, `vars(varsBlock{2})`, plus the variables from the first block (these variables are known at this time). Thus, if a nontrivial block decomposition is possible, you can split the solution process for a large system of equations involving many variables into several steps, where each step involves a smaller subsystem.

The number of blocks `length(eqsBlocks)` coincides with `length(varsBlocks)`. If `length(eqsBlocks) = length(varsBlocks) = 1`, then a nontrivial block decomposition of the equations is not possible.

Examples

Block Lower Triangular Decomposition of DAE System

Compute a block lower triangular decomposition (BLT decomposition) of a symbolic system of differential algebraic equations (DAEs).

Create the following system of four differential algebraic equations. Here, the symbolic function calls `x1(t)`, `x2(t)`, `x3(t)`, and `x4(t)` represent the state variables of the system. The system also contains symbolic parameters `c1`, `c2`, `c3`, `c4`, and functions `f(t, x, y)` and `g(t, x, y)`.

```
syms x1(t) x2(t) x3(t) x4(t)
syms c1 c2 c3 c4
syms f(t,x,y) g(t,x,y)

eqs = [c1*diff(x1(t),t)+c2*diff(x3(t),t)==c3*f(t,x1(t),x3(t));...
       c2*diff(x1(t),t)+c1*diff(x3(t),t)==c4*g(t,x3(t),x4(t));...
       x1(t)==g(t,x1(t),x3(t));...
       x2(t)==f(t,x3(t),x4(t))];

vars = [x1(t), x2(t), x3(t), x4(t)];
```

Use `findDecoupledBlocks` to find the block structure of the system.

```
[eqsBlocks, varsBlocks] = findDecoupledBlocks(eqs, vars)
```

```
eqsBlocks =
  1×3 cell array
    {1×2 double}    {[2]}    {[4]}
varsBlocks =
  1×3 cell array
    {1×2 double}    {[4]}    {[2]}
```

The first block contains two equations in two variables.

```
eqs(eqsBlocks{1})
```

```
ans =
  c1*diff(x1(t), t) + c2*diff(x3(t), t) == c3*f(t, x1(t), x3(t))
  x1(t) == g(t, x1(t), x3(t))
```

```
vars(varsBlocks{1})
```

```
ans =
  [ x1(t), x3(t)]
```

After you solve this block for the variables $x_1(t)$, $x_3(t)$, you can solve the next block of equations. This block consists of one equation.

```
eqs(eqsBlocks{2})
```

```
ans =
  c2*diff(x1(t), t) + c1*diff(x3(t), t) == c4*g(t, x3(t), x4(t))
```

The block involves one variable.

```
vars(varsBlocks{2})
```

```
ans =
  x4(t)
```

After you solve the equation from block 2 for the variable $x_4(t)$, the remaining block of equations, `eqs(eqsBlocks{3})`, defines the remaining variable, `vars(varsBlocks{3})`.

```
eqs(eqsBlocks{3})
vars(varsBlocks{3})
```

```
ans =
  x2(t) == f(t, x3(t), x4(t))
```

```
ans =
  x2(t)
```

Find the permutations that convert the system to a block lower triangular form.

```
eqsPerm = [eqsBlocks{:}]
varsPerm = [varsBlocks{:}]
```

```
eqsPerm =
  1    3    2    4
```

```
varsPerm =
  1    3    4    2
```

Convert the system to a block lower triangular system of equations.

```
eqs = eqs(eqsPerm)
vars = vars(varsPerm)

eqs =
  c1*diff(x1(t), t) + c2*diff(x3(t), t) == c3*f(t, x1(t), x3(t))
                                     x1(t) == g(t, x1(t), x3(t))
  c2*diff(x1(t), t) + c1*diff(x3(t), t) == c4*g(t, x3(t), x4(t))
                                     x2(t) == f(t, x3(t), x4(t))

vars =
[ x1(t), x3(t), x4(t), x2(t)]
```

Find the incidence matrix of the resulting system. The incidence matrix shows that the system of permuted equations has three diagonal blocks of size 2-by-2, 1-by-1, and 1-by-1.

```
incidenceMatrix(eqs, vars)
```

```
ans =
     1     1     0     0
     1     1     0     0
     1     1     1     0
     0     1     1     1
```

BLT Decomposition and Solution of Linear System

Find blocks of equations in a linear algebraic system, and then solve the system by sequentially solving each block of equations starting from the first one.

Create the following system of linear algebraic equations.

```
syms x1 x2 x3 x4 x5 x6 c1 c2 c3

eqs = [c1*x1 + x3 + x5 == c1 + c2 + 1;...
       x1 + x3 + x4 + 2*x6 == 4 + c2;...
       x1 + 2*x3 + c3*x5 == 1 + 2*c2 + c3;...
       x2 + x3 + x4 + x5 == 2 + c2;...
       x1 - c2*x3 + x5 == 2 - c2^2;...
       x1 - x3 + x4 - x6 == 1 - c2];
```

```
vars = [x1, x2, x3, x4, x5, x6];
```

Use `findDecoupledBlocks` to convert the system to a lower triangular form. For this system, `findDecoupledBlocks` identifies three blocks of equations and corresponding variables.

```
[eqsBlocks, varsBlocks] = findDecoupledBlocks(eqs, vars)
```

```
eqsBlocks =
  1×3 cell array
    {1×3 double}    {1×2 double}    {[4]}
varsBlocks =
  1×3 cell array
    {1×3 double}    {1×2 double}    {[2]}
```

Identify the variables in the first block. This block consists of three equations in three variables.

```
vars(varsBlocks{1})
```

```
ans =  
[ x1, x3, x5]
```

Solve the first block of equations for the first block of variables assigning the solutions to the corresponding variables.

```
[x1,x3,x5] = solve(eqs(eqsBlocks{1}), vars(varsBlocks{1}))
```

```
x1 =  
1
```

```
x3 =  
c2
```

```
x5 =  
1
```

Identify the variables in the second block. This block consists of two equations in two variables.

```
vars(varsBlocks{2})
```

```
ans =  
[ x4, x6]
```

Solve this block of equations assigning the solutions to the corresponding variables.

```
[x4, x6] = solve(eqs(eqsBlocks{2}), vars(varsBlocks{2}))
```

```
x4 =  
x3/3 - x1 - c2/3 + 2
```

```
x6 =  
(2*c2)/3 - (2*x3)/3 + 1
```

Use `subs` to evaluate the result for the already known values of variables `x1`, `x3`, and `x5`.

```
x4 = subs(x4)  
x6 = subs(x6)
```

```
x4 =  
1
```

```
x6 =  
1
```

Identify the variables in the third block. This block consists of one equation in one variable.

```
vars(varsBlocks{3})
```

```
ans =  
x2
```

Solve this equation assigning the solution to `x2`.

```
x2 = solve(eqs(eqsBlocks{3}), vars(varsBlocks{3}))
```

```
x2 =  
c2 - x3 - x4 - x5 + 2
```

Use `subs` to evaluate the result for the already known values of all other variables of this system.

```
x2 = subs(x2)
```

```
x2 =
0
```

Alternatively, you can rewrite this example using the `for`-loop. This approach lets you use the example for larger systems of equations.

```
syms x1 x2 x3 x4 x5 x6 c1 c2 c3
```

```
eqs = [c1*x1 + x3 + x5 == c1 + c2 + 1;...
       x1 + x3 + x4 + 2*x6 == 4 + c2;...
       x1 + 2*x3 + c3*x5 == 1 + 2*c2 + c3;...
       x2 + x3 + x4 + x5 == 2 + c2;...
       x1 - c2*x3 + x5 == 2 - c2^2
       x1 - x3 + x4 - x6 == 1 - c2];
```

```
vars = [x1, x2, x3, x4, x5, x6];
```

```
[eqsBlocks, varsBlocks] = findDecoupledBlocks(eqs, vars);
```

```
vars_sol = vars;
```

```
for i = 1:numel(eqsBlocks)
    sol = solve(eqs(eqsBlocks{i}), vars(varsBlocks{i}));
    vars_sol_per_block = subs(vars(varsBlocks{i}), sol);
    for k=1:i-1
        vars_sol_per_block = subs(vars_sol_per_block, vars(varsBlocks{k}),...
                                   vars_sol(varsBlocks{k}));
    end
    vars_sol(varsBlocks{i}) = vars_sol_per_block
end
```

```
vars_sol =
[ 1, x2, c2, x4, 1, x6]
```

```
vars_sol =
[ 1, x2, c2, 1, 1, 1]
```

```
vars_sol =
[ 1, 0, c2, 1, 1, 1]
```

Input Arguments

eqs — System of equations

vector of symbolic equations | vector of symbolic expressions

System of equations, specified as a vector of symbolic equations or expressions.

vars — Variables

vector of symbolic variables | vector of symbolic functions | vector of symbolic function calls

Variables, specified as a vector of symbolic variables, functions, or function calls, such as $x(t)$.

Example: $[x(t), y(t)]$ or $[x(t); y(t)]$

Output Arguments

eqsBlocks — Indices defining blocks of equations

cell array

Indices defining blocks of equations, returned as a cell array. Each block of indices is a row vector of double-precision integer numbers. The i th block of equations consists of the equations `eqs(eqsBlocks{i})` and involves only the variables in `vars(varsBlocks{1:i})`.

varsBlocks — Indices defining blocks of variables

cell array

Indices defining blocks of variables, returned as a cell array. Each block of indices is a row vector of double-precision integer numbers. The i th block of equations consists of the equations `eqs(eqsBlocks{i})` and involves only the variables in `vars(varsBlocks{1:i})`.

Tips

- The implemented algorithm requires that for each variable in `vars` there must be at least one matching equation in `eqs` involving this variable. The same equation cannot also be matched to another variable. If the system does not satisfy this condition, then `findDecoupledBlocks` throws an error. In particular, `findDecoupledBlocks` requires that `length(eqs) = length(vars)`.
- Applying the permutations `e = [eqsBlocks{:}]` to the vector `eqs` and `v = [varsBlocks{:}]` to the vector `vars` produces an incidence matrix `incidenceMatrix(eqs(e), vars(v))` that has a block lower triangular sparsity pattern.

See Also

`daeFunction` | `decic` | `diag` | `incidenceMatrix` | `isLowIndexDAE` | `massMatrixForm` | `odeFunction` | `reduceDAEIndex` | `reduceDAEToODE` | `reduceDifferentialOrder` | `reduceRedundancies` | `tril` | `triu`

Introduced in R2014b

findSymType

Find symbolic subobjects of specific type

Syntax

```
X = findSymType(symObj,type)
X = findSymType(symObj,funType,vars)
```

Description

`X = findSymType(symObj,type)` returns a vector of symbolic subobjects of type `type` from the symbolic object `symObj`. The input `type` must be a case-sensitive string scalar or character vector, and it can include a logical expression.

- If `symObj` does not contain a symbolic subobject of type `type`, then `findSymType` returns an empty scalar.
- If `symObj` contains several subexpressions of type `type`, then `findSymType` returns the largest matching subexpression.

`X = findSymType(symObj,funType,vars)` returns a vector of unassigned symbolic functions that depend on the variables `vars` from the symbolic input `symObj`.

You can set the function type `funType` to `'symfunOf'` or `'symfunDependingOn'`. For example, `syms f(x); findSymType(f,'symfunOf',x)` returns `f(x)`.

Examples

Symbolic Number and Constant

Find and return specific symbolic numbers and constants in a symbolic expression.

Create a symbolic expression.

```
expr = sym('1/2')*pi + vpa(pi)
expr =
     $\frac{\pi}{2} + 3.1415926535897932384626433832795$ 
```

Find symbolic numbers of type `'integer'`.

```
X = findSymType(expr,'integer')
```

```
X = (1 2)
```

Find symbolic numbers of type `'integer | real'`.

```
X = findSymType(expr,'integer | real')
```

```
X =
```

$$\left(\frac{1}{2} 3.1415926535897932384626433832795\right)$$

Find symbolic numbers of type 'vpereal'.

```
X = findSymType(expr, 'vpereal')
```

```
X = 3.1415926535897932384626433832795
```

Find symbolic numbers of type 'complex'.

```
X = findSymType(expr, 'complex')
```

```
X =
```

```
Empty sym: 1-by-0
```

The `findSymType` function returns an empty scalar since the expression `expr` does not contain any complex numbers.

Now find symbolic constant of type 'constant'.

```
X = findSymType(expr, 'constant')
```

```
X =
```

$$\frac{\pi}{2} + 3.1415926535897932384626433832795$$

When there are several subexpressions of type 'constant', `findSymType` returns the largest matching subexpression.

Symbolic Variable and Function

Find and return symbolic variables and functions in a symbolic equation.

Create a symbolic equation.

```
syms y(t) k
eq = diff(y) + k*y == sin(y)
```

```
eq(t) =
```

$$\frac{\partial}{\partial t} y(t) + k y(t) = \sin(y(t))$$

Find symbolic variables of type 'variable' in the equation.

```
X = findSymType(eq, 'variable')
```

```
X = (k t)
```

Find an unassigned symbolic function of type 'symfun' in the equation.

```
X = findSymType(eq, 'symfun')
```

```
X = y(t)
```

Find a symbolic math function of type 'diff' in the equation.

```
X = findSymType(eq, 'diff')
```

```
X =
 $\frac{\partial}{\partial t} y(t)$ 
```

Symbolic Function of Specific Variables

Find and return symbolic functions with specific variable dependencies in an expression.

Create a symbolic expression.

```
syms n f(x) g(x) y(x,t)
expr = x + f(x^n) + g(x) + y(x,t)
```

```
expr = x + f(x^n) + g(x) + y(x,t)
```

Find unassigned symbolic functions of type 'symfun' in the expression.

```
X = findSymType(expr, 'symfun')
```

```
X = (f(x^n) g(x) y(x,t))
```

Find symbolic functions that depend on the exact sequence of variables [x t] using 'symfunOf'.

```
X = findSymType(expr, 'symfunOf', [x t])
```

```
X = y(x,t)
```

Find symbolic functions that have a dependency on the variable x using 'symfunDependingOn'.

```
X = findSymType(expr, 'symfunDependingOn', x)
```

```
X = (g(x) y(x,t))
```

Input Arguments

symObj — Symbolic objects

symbolic expressions | symbolic functions | symbolic variables | symbolic numbers | symbolic units

Symbolic objects, specified as symbolic expressions, symbolic functions, symbolic variables, symbolic numbers, or symbolic units.

type — Symbolic types

scalar string | character vector

Symbolic types, specified as a case-sensitive scalar string or character vector. The input type can contain a logical expression. The value options follow.

Symbolic Type Category	String Values
numbers	<ul style="list-style-type: none"> 'integer' — integer numbers 'rational' — rational numbers 'vpareal' — variable-precision floating-point real numbers 'complex' — complex numbers 'real' — real numbers, including 'integer', 'rational', and 'vpareal' 'number' — numbers, including 'integer', 'rational', 'vpareal', 'complex', and 'real'
constants	'constant' — symbolic constants, including 'number'
symbolic math functions	'vpa', 'sin', 'exp', and so on — symbolic math functions in symbolic expressions
unassigned symbolic functions	<ul style="list-style-type: none"> 'F', 'g', and so on — function name of an unassigned symbolic function 'symfun' — unassigned symbolic functions
arithmetic operators	<ul style="list-style-type: none"> 'plus' — addition operator + and subtraction operator - 'times' — multiplication operator * and division operator / 'power' — power or exponentiation operator ^ and square root operator sqrt
variables	'variable' — symbolic variables
units	'units' — symbolic units
expressions	'expression' — symbolic expressions, including all of the preceding symbolic types
logical expressions	<ul style="list-style-type: none"> 'or' — logical OR operator 'and' — logical AND operator & 'not' — logical NOT operator ~ 'xor' — logical exclusive-OR operator xor 'logicalexpression' — logical expressions, including 'or', 'and', 'not', and 'xor'
equations and inequalities	<ul style="list-style-type: none"> 'eq' — equality operator == 'ne' — inequality operator ~= 'lt' — less-than operator < or greater-than operator > 'le' — less-than-or-equal-to operator <= or greater-than-or-equal-to operator >= 'equation' — symbolic equations and inequalities, including 'eq', 'ne', 'lt', and 'le'
unsupported symbolic types	'unsupported' — unsupported symbolic types

If `symObj` contains several subexpressions of type `type`, then `findSymType` returns the largest matching subexpression (topmost matching node in a tree data structure).

funType – Function type`'symfunOf' | 'symfunDependingOn'`

Function type, specified as `'symfunOf'` or `'symfunDependingOn'`.

- `'symfunOf'` finds and returns the unassigned symbolic functions that depend on the exact sequence of variables specified by the array `vars`. For example, `syms f(x,y); findSymType(f,'symfunOf',[x y])` returns `f(x,y)`.
- `'symfunDependingOn'` finds and returns the unassigned symbolic functions that have a dependency on the variables specified by the array `vars`. For example, `syms f(x,y); findSymType(f,'symfunDependingOn',x)` returns `f(x,y)`.

vars – Input variables`symbolic variables | symbolic array`

Input variables, specified as symbolic variables or a symbolic array.

See Also`hasSymType | isSymType | mapSymType | sym | symFunType | symType | syms`**Introduced in R2019a**

findUnits

Find units in input

Syntax

```
U = findUnits(expr)
```

Description

`U = findUnits(expr)` returns a row vector of units in the symbolic expression `expr`.

Examples

Find Units in Expression

Find the units in an expression by using `findUnits`.

```
u = symunit;
syms x
units = findUnits(x*u.m + 2*u.N)
```

```
units =
[ [N], [m]]
```

Find Units in Array of Equations or Expressions

Find the units in an array of equations or expressions by using `findUnits`. The `findUnits` function concatenates all units found in the input to return a row vector of units. `findUnits` returns only base units.

```
u = symunit;
array = [2*u.m + 3*u.K, 1*u.N == 1*u.kg/(u.m*u.s^2)];
units = findUnits(array)
```

```
units =
[ [K], [N], [kg], [m], [s]]
```

Input Arguments

`expr` — Input

symbolic number | symbolic variable | symbolic vector | symbolic matrix | symbolic multidimensional array | symbolic function | symbolic expression

Input, specified as a symbolic number, variable, vector, matrix, multidimensional array, function, or expression.

See Also

`checkUnits` | `isUnit` | `newUnit` | `separateUnits` | `str2symunit` | `symunit` | `symunit2str` | `unitConversionFactor`

Topics

“Units of Measurement Tutorial” on page 2-19

“Unit Conversions and Unit Systems” on page 2-39

“Units and Unit Systems List” on page 2-25

External Websites

The International System of Units (SI)

Introduced in R2017a

finverse

Functional inverse

Syntax

```
g = finverse(f)
g = finverse(f,var)
```

Description

`g = finverse(f)` returns the inverse of function `f`, such that $f(g(x)) = x$. If `f` contains more than one variable, use the next syntax to specify the independent variable.

`g = finverse(f,var)` uses the symbolic variable `var` as the independent variable, such that $f(g(var)) = var$.

Examples

Compute Functional Inverse

Compute functional inverse for this trigonometric function.

```
syms x
f(x) = 1/tan(x);
g = finverse(f)
```

```
g(x) =
atan(1/x)
```

Compute functional inverse for this exponential function by specifying the independent variable.

```
syms u v
finverse(exp(u-2*v), u)
```

```
ans =
2*v + log(u)
```

Input Arguments

f – Input

symbolic expression | symbolic function

Input, specified as a symbolic expression or function.

var – Independent variable

symbolic variable

Independent variable, specified as a symbolic variable.

Tips

- `finverse` does not issue a warning when the inverse is not unique.

See Also

`compose` | `syms`

Introduced before R2006a

fmesh

Plot 3-D mesh

Syntax

```
fmesh(f)
fmesh(f,[min max])
fmesh(f,[xmin xmax ymin ymax])

fmesh(funx,funy,funz)
fmesh(funx,funy,funz,[uvmin uvmax])
fmesh(funx,funy,funz,[umin umax vmin vmax])

fmesh( ____,LineStyle)
fmesh( ____,Name,Value)
fmesh(ax, ____)
obj = fmesh( ____)
```

Description

`fmesh(f)` creates a mesh plot of the symbolic expression $f(x, y)$ over the default interval $[-5 \ 5]$ for x and y .

`fmesh(f,[min max])` plots $f(x, y)$ over the interval $[min \ max]$ for x and y .

`fmesh(f,[xmin xmax ymin ymax])` plots $f(x, y)$ over the interval $[xmin \ xmax]$ for x and $[ymin \ ymax]$ for y . The `fmesh` function uses `symvar` to order the variables and assign intervals.

`fmesh(funx,funy,funz)` plots the parametric mesh $x = x(u, v)$, $y = y(u, v)$, $z = z(u, v)$ over the interval $[-5 \ 5]$ for u and v .

`fmesh(funx,funy,funz,[uvmin uvmax])` plots the parametric mesh $x = x(u, v)$, $y = y(u, v)$, $z = z(u, v)$ over the interval $[uvmin \ uvmax]$ for u and v .

`fmesh(funx,funy,funz,[umin umax vmin vmax])` plots the parametric mesh $x = x(u, v)$, $y = y(u, v)$, $z = z(u, v)$ over the interval $[umin \ umax]$ for u and $[vmin \ vmax]$ for v . The `fmesh` function uses `symvar` to order the parametric variables and assign intervals.

`fmesh(____,LineStyle)` uses the `LineStyle` to set the line style, marker symbol, and plot color.

`fmesh(____,Name,Value)` specifies surface properties using one or more `Name, Value` pair arguments. Use this option with any of the input argument combinations in the previous syntaxes.

`fmesh(ax, ____)` plots into the axes with the object `ax` instead of the current axes object `gca`.

`obj = fmesh(____)` returns a function surface object or a parameterized function surface object. Use the object to query and modify properties of a specific mesh.

Examples

Additional Examples: See fsurf Page

Note For additional examples, follow the fsurf page because fmesh and fsurf share the same syntax. All examples on the fsurf page apply to fmesh.

3-D Mesh Plot of Symbolic Expression

Plot a mesh of the input $\sin(x) + \cos(y)$ over the default range $-5 < x < 5$ and $-5 < y < 5$.

```
syms x y
fmesh(sin(x)+cos(y))
```

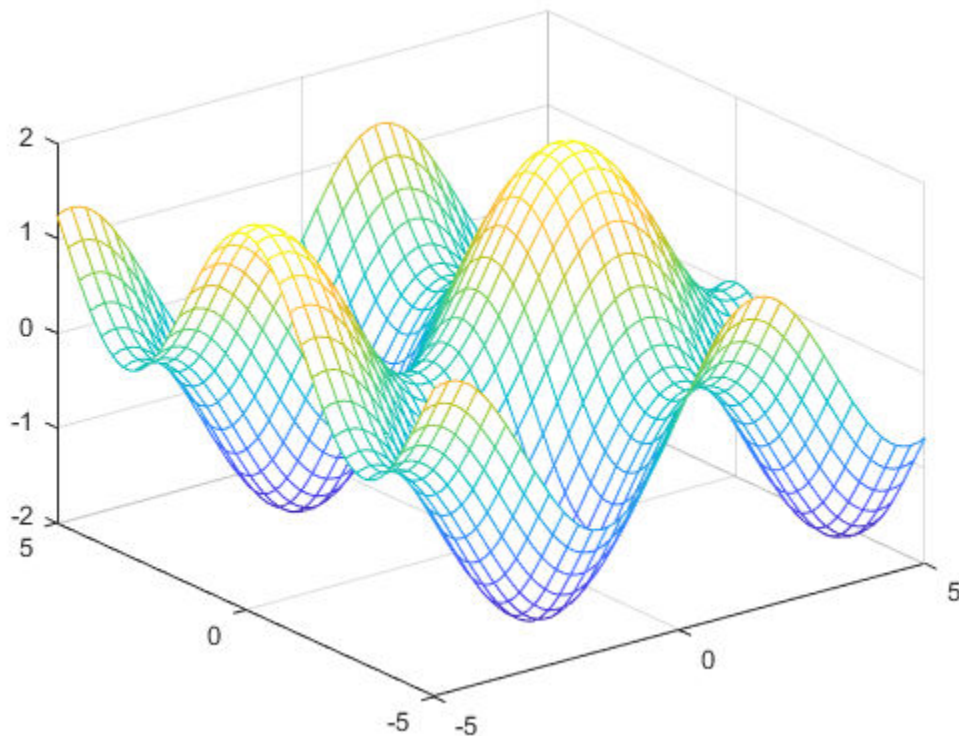

3-D Mesh Plot of Symbolic Function

Plot a 3-D mesh of the real part of $\tan^{-1}(x + iy)$ over the default range $-5 < x < 5$ and $-5 < y < 5$.

```
syms f(x,y)
f(x,y) = real(atan(x + i*y));
fmesh(f)
```

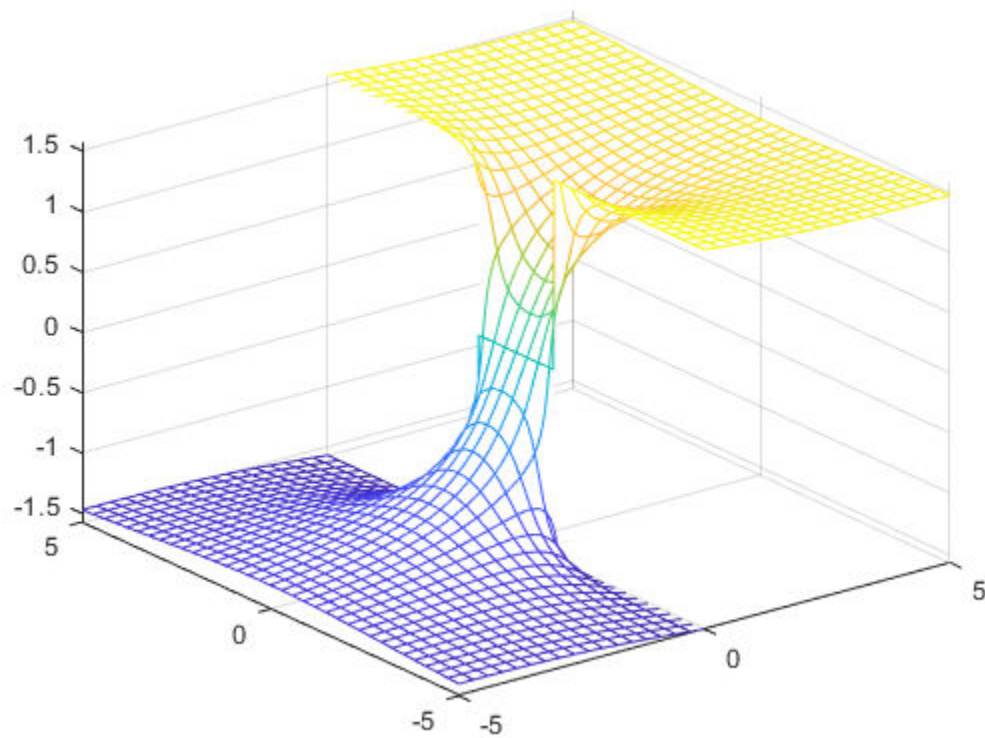

Specify Plotting Interval of Mesh Plot

Plot $\sin(x) + \cos(y)$ over $-\pi < x < \pi$ and $-5 < y < 5$ by specifying the plotting interval as the second argument of `fmesh`.

```
syms x y
f = sin(x) + cos(y);
fmesh(f, [-pi pi -5 5])
```

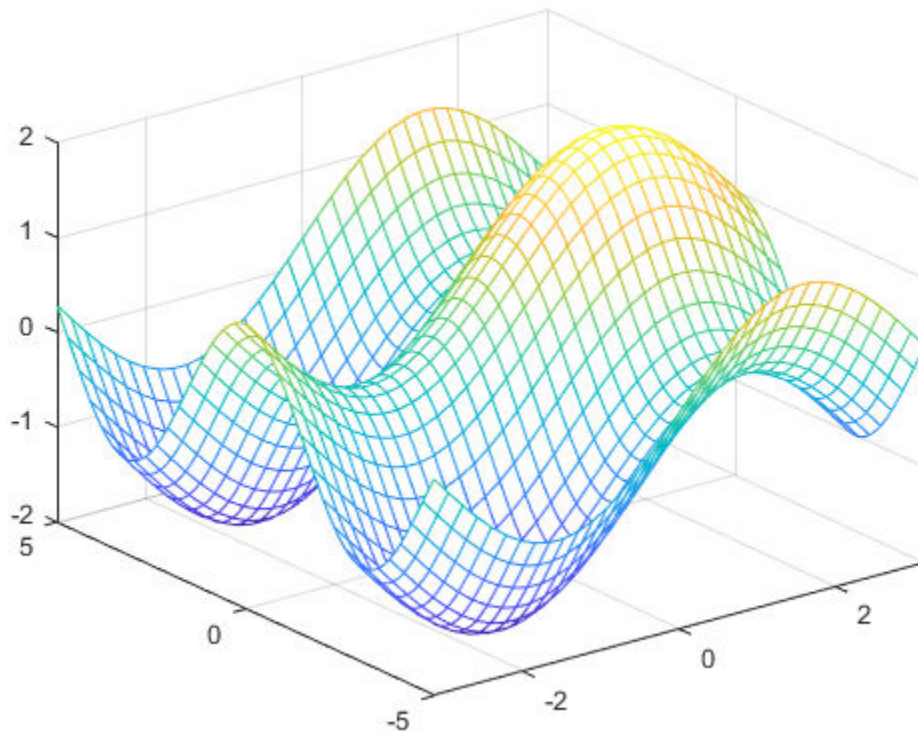

Parameterized Mesh Plot

Plot the parameterized mesh

$$x = r \cos(s) \sin(t)$$

$$y = r \sin(s) \sin(t)$$

$$z = r \cos(t)$$

$$\text{where } r = 8 + \sin(7s + 5t)$$

for $0 < s < 2\pi$ and $0 < t < \pi$. Make the aspect ratio of the axes equal using `axis equal`. See the entire mesh by making the mesh partially transparent using `alpha`.

```
syms s t
r = 8 + sin(7*s + 5*t);
x = r*cos(s)*sin(t);
y = r*sin(s)*sin(t);
z = r*cos(t);
fmesh(x, y, z, [0 2*pi 0 pi], 'Linewidth', 2)
axis equal
```

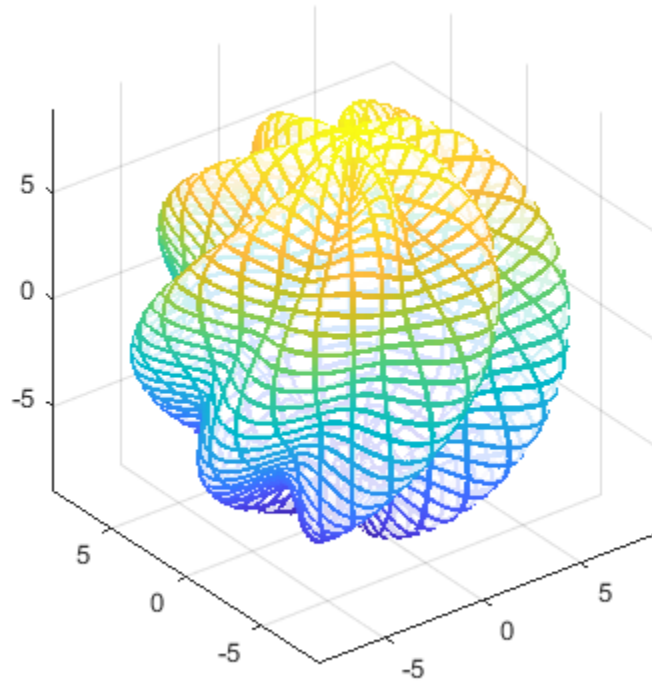

`alpha(0.8)`

Additional Examples: See [fsurf Page](#)

Note For additional examples, follow the [fsurf](#) page because `fmesh` and `fsurf` share the same syntax. All examples on the [fsurf](#) page apply to `fmesh`.

Input Arguments

f — 3-D expression or function to be plotted

symbolic expression | symbolic function

Expression or function to be plotted, specified as a symbolic expression or function.

[min max] — Plotting interval for x- and y-axes

`[-5 5]` (default) | vector of two numbers

Plotting interval for x- and y-axes, specified as a vector of two numbers. The default is `[-5 5]`.

[xmin xmax ymin ymax] — Plotting interval for x- and y-axes

`[-5 5 -5 5]` (default) | vector of four numbers

Plotting interval for x- and y-axes, specified as a vector of four numbers. The default is `[-5 5 -5 5]`.

funx, funy, funz — Parametric functions of u and v

symbolic expressions | symbolic functions

Parametric functions of u and v , specified as a symbolic expression or function.

[uvmin uvmax] — Plotting interval for u and v

[-5 5] (default) | vector of two numbers

Plotting interval for u and v axes, specified as a vector of two numbers. The default is [-5 5].

[umin umax vmin vmax] — Plotting interval for u and v

[-5 5 -5 5] (default) | vector of four numbers

Plotting interval for u and v , specified as a vector of four numbers. The default is [-5 5 -5 5].

ax — Axes object

axes object

Axes object. If you do not specify an axes object, then `fmesh` uses the current axes.

LineStyle — Line style, marker symbol, and line color

character vector

Line style, marker symbol, and line color, specified as a character vector. The elements of the character vector can appear in any order, and you can omit one or more options from the character vector specifier.

Example: '- -or' is a red mesh with circle markers

Specifier	Line Style
-	Solid line (default)
--	Dashed line
:	Dotted line
-.	Dash-dot line

Specifier	Marker
o	Circle
+	Plus sign
*	Asterisk
.	Point
x	Cross
s	Square
d	Diamond
^	Upward-pointing triangle
v	Downward-pointing triangle
>	Right-pointing triangle
<	Left-pointing triangle

Specifier	Marker
p	Pentagram
h	Hexagram

Specifier	Color
y	yellow
m	magenta
c	cyan
r	red
g	green
b	blue
w	white
k	black

Name-Value Pair Arguments

Specify optional comma-separated pairs of `Name`, `Value` arguments. `Name` is the argument name and `Value` is the corresponding value. `Name` must appear inside quotes. You can specify several name and value pair arguments in any order as `Name1, Value1, ..., NameN, ValueN`.

Example: `'Marker', 'o', 'MarkerFaceColor', 'red'`

MeshDensity — Number of evaluation points per direction

35 (default) | number

Number of evaluation points per direction, specified as a number. The default is 35. Because `fmesh` objects use adaptive evaluation, the actual number of evaluation points is greater.

Example: 100

ShowContours — Display contour plot under plot

'off' (default) | on/off logical value

Display contour plot under plot, specified as `'on'` or `'off'`, or as numeric or logical 1 (`true`) or 0 (`false`). A value of `'on'` is equivalent to `true`, and `'off'` is equivalent to `false`. Thus, you can use the value of this property as a logical value. The value is stored as an on/off logical value of type `matlab.lang.OnOffSwitchState`.

EdgeColor — Line color

'interp' (default) | RGB triplet | hexadecimal color code | 'r' | 'g' | 'b' | ...







Line color, specified as `'interp'`, an RGB triplet, a hexadecimal color code, a color name, or a short name. The default value of `'interp'` colors the edges based on the `ZData` property values.

For a custom color, specify an RGB triplet or a hexadecimal color code.

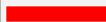

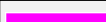
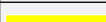

- An RGB triplet is a three-element row vector whose elements specify the intensities of the red, green, and blue components of the color. The intensities must be in the range `[0, 1]`; for example, `[0.4 0.6 0.7]`.

- A hexadecimal color code is a character vector or a string scalar that starts with a hash symbol (#) followed by three or six hexadecimal digits, which can range from 0 to F. The values are not case sensitive. Thus, the color codes '#FF8800', '#ff8800', '#F80', and '#f80' are equivalent.

Alternatively, you can specify some common colors by name. This table lists the named color options, the equivalent RGB triplets, and hexadecimal color codes.

Color Name	Short Name	RGB Triplet	Hexadecimal Color Code	Appearance
'red'	'r'	[1 0 0]	'#FF0000'	
'green'	'g'	[0 1 0]	'#00FF00'	
'blue'	'b'	[0 0 1]	'#0000FF'	
'cyan'	'c'	[0 1 1]	'#00FFFF'	
'magenta'	'm'	[1 0 1]	'#FF00FF'	
'yellow'	'y'	[1 1 0]	'#FFFF00'	
'black'	'k'	[0 0 0]	'#000000'	
'white'	'w'	[1 1 1]	'#FFFFFF'	
'none'	Not applicable	Not applicable	Not applicable	No color

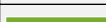
Here are the RGB triplets and hexadecimal color codes for the default colors MATLAB uses in many types of plots.

RGB Triplet	Hexadecimal Color Code	Appearance
[0 0.4470 0.7410]	'#0072BD'	
[0.8500 0.3250 0.0980]	'#D95319'	
[0.9290 0.6940 0.1250]	'#EDB120'	
[0.4940 0.1840 0.5560]	'#7E2F8E'	
[0.4660 0.6740 0.1880]	'#77AC30'	
[0.3010 0.7450 0.9330]	'#4DBEEE'	
[0.6350 0.0780 0.1840]	'#A2142F'	

Example: 'blue'

Example: [0 0 1]



Example: '#0000FF'

LineStyle – Line style

'-' (default) | '--' | ':' | '-.' | 'none'

Line style, specified as one of the options listed in this table.

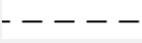
Line Style	Description	Resulting Line
'-'	Solid line	

Line Style	Description	Resulting Line
'--'	Dashed line	
':'	Dotted line	
'-.'	Dash-dotted line	
'none'	No line	No line

LineWidth — Line width

0.5 (default) | positive value

Line width, specified as a positive value in points, where 1 point = 1/72 of an inch. If the line has markers, then the line width also affects the marker edges.

The line width cannot be thinner than the width of a pixel. If you set the line width to a value that is less than the width of a pixel on your system, the line displays as one pixel wide.

Marker — Marker symbol

'none' (default) | 'o' | '+' | '*' | '.' | 'x' | 's' | 'd' | ...

Marker symbol, specified as one of the values in this table. By default, a line does not have markers. Add markers at selected points along the line by specifying a marker.

Value	Description
'o'	Circle
'+'	Plus sign
'*'	Asterisk
'.'	Point
'x'	Cross
'square' or 's'	Square
'diamond' or 'd'	Diamond
'^'	Upward-pointing triangle
'v'	Downward-pointing triangle
'>'	Right-pointing triangle
'<'	Left-pointing triangle
'pentagram' or 'p'	Five-pointed star (pentagram)
'hexagram' or 'h'	Six-pointed star (hexagram)
'none'	No markers

MarkerEdgeColor — Marker outline color





'auto' (default) | RGB triplet | hexadecimal color code | 'r' | 'g' | 'b' | ...

Marker outline color, specified as 'auto', an RGB triplet, a hexadecimal color code, a color name, or a short name. The default value of 'auto' uses the same color as the EdgeColor property.



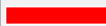
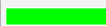

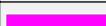
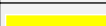
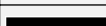

For a custom color, specify an RGB triplet or a hexadecimal color code.

- An RGB triplet is a three-element row vector whose elements specify the intensities of the red, green, and blue components of the color. The intensities must be in the range $[0, 1]$; for example, $[0.4 \ 0.6 \ 0.7]$.
- A hexadecimal color code is a character vector or a string scalar that starts with a hash symbol (#) followed by three or six hexadecimal digits, which can range from 0 to F. The values are not case sensitive. Thus, the color codes '#FF8800', '#ff8800', '#F80', and '#f80' are equivalent.

Alternatively, you can specify some common colors by name. This table lists the named color options, the equivalent RGB triplets, and hexadecimal color codes.

Color Name	Short Name	RGB Triplet	Hexadecimal Color Code	Appearance
'red'	'r'	[1 0 0]	'#FF0000'	
'green'	'g'	[0 1 0]	'#00FF00'	
'blue'	'b'	[0 0 1]	'#0000FF'	
'cyan'	'c'	[0 1 1]	'#00FFFF'	
'magenta'	'm'	[1 0 1]	'#FF00FF'	
'yellow'	'y'	[1 1 0]	'#FFFF00'	
'black'	'k'	[0 0 0]	'#000000'	
'white'	'w'	[1 1 1]	'#FFFFFF'	
'none'	Not applicable	Not applicable	Not applicable	No color

Here are the RGB triplets and hexadecimal color codes for the default colors MATLAB uses in many types of plots.

RGB Triplet	Hexadecimal Color Code	Appearance
[0 0.4470 0.7410]	'#0072BD'	
[0.8500 0.3250 0.0980]	'#D95319'	
[0.9290 0.6940 0.1250]	'#EDB120'	
[0.4940 0.1840 0.5560]	'#7E2F8E'	
[0.4660 0.6740 0.1880]	'#77AC30'	
[0.3010 0.7450 0.9330]	'#4DBEEE'	
[0.6350 0.0780 0.1840]	'#A2142F'	

Example: `[0.5 0.5 0.5]`

Example: `'blue'`

Example: `'#D2F9A7'`

MarkerFaceColor — Marker fill color







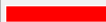

'none' (default) | 'auto' | RGB triplet | hexadecimal color code | 'r' | 'g' | 'b' | ...

Marker fill color, specified as 'auto', an RGB triplet, a hexadecimal color code, a color name, or a short name. The 'auto' value uses the same color as the MarkerEdgeColor property.



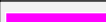



For a custom color, specify an RGB triplet or a hexadecimal color code.

- An RGB triplet is a three-element row vector whose elements specify the intensities of the red, green, and blue components of the color. The intensities must be in the range $[0, 1]$; for example, $[0.4 \ 0.6 \ 0.7]$.
- A hexadecimal color code is a character vector or a string scalar that starts with a hash symbol (#) followed by three or six hexadecimal digits, which can range from 0 to F. The values are not case sensitive. Thus, the color codes '#FF8800', '#ff8800', '#F80', and '#f80' are equivalent.

Alternatively, you can specify some common colors by name. This table lists the named color options, the equivalent RGB triplets, and hexadecimal color codes.

Color Name	Short Name	RGB Triplet	Hexadecimal Color Code	Appearance
'red'	'r'	[1 0 0]	'#FF0000'	
'green'	'g'	[0 1 0]	'#00FF00'	
'blue'	'b'	[0 0 1]	'#0000FF'	
'cyan'	'c'	[0 1 1]	'#00FFFF'	
'magenta'	'm'	[1 0 1]	'#FF00FF'	
'yellow'	'y'	[1 1 0]	'#FFFF00'	
'black'	'k'	[0 0 0]	'#000000'	
'white'	'w'	[1 1 1]	'#FFFFFF'	
'none'	Not applicable	Not applicable	Not applicable	No color

Here are the RGB triplets and hexadecimal color codes for the default colors MATLAB uses in many types of plots.

RGB Triplet	Hexadecimal Color Code	Appearance
[0 0.4470 0.7410]	'#0072BD'	
[0.8500 0.3250 0.0980]	'#D95319'	
[0.9290 0.6940 0.1250]	'#EDB120'	
[0.4940 0.1840 0.5560]	'#7E2F8E'	
[0.4660 0.6740 0.1880]	'#77AC30'	
[0.3010 0.7450 0.9330]	'#4DBEEE'	
[0.6350 0.0780 0.1840]	'#A2142F'	

Example: $[0.3 \ 0.2 \ 0.1]$

Example: 'green'

Example: '#D2F9A7'

MarkerSize — Marker size

6 (default) | positive value

Marker size, specified as a positive value in points, where 1 point = 1/72 of an inch.

Output Arguments

obj — One or more objects

scalar | vector

One or more objects, returned as a scalar or a vector. The object is either a function surface object or parameterized mesh object, depending on the type of plot. You can use these objects to query and modify properties of a specific line. For details, see [Function Surface](#) and [Parameterized Function Surface](#).

Algorithms

`fmesh` assigns the symbolic variables in `f` to the `x` axis, then the `y` axis, and `symvar` determines the order of the variables to be assigned. Therefore, variable and axis names might not correspond. To force `fmesh` to assign `x` or `y` to its corresponding axis, create the symbolic function to plot, then pass the symbolic function to `fmesh`.

For example, the following code plots the mesh of $f(x,y) = \sin(y)$ in two ways. The first way forces the waves to oscillate with respect to the `y` axis. The second way assigns `y` to the `x` axis because it is the first (and only) variable in the symbolic function.

```
syms x y;  
f(x,y) = sin(y);  
  
figure;  
subplot(2,1,1)  
fmesh(f);  
subplot(2,1,2)  
fmesh(f(x,y)); % Or fmesh(sin(y));
```

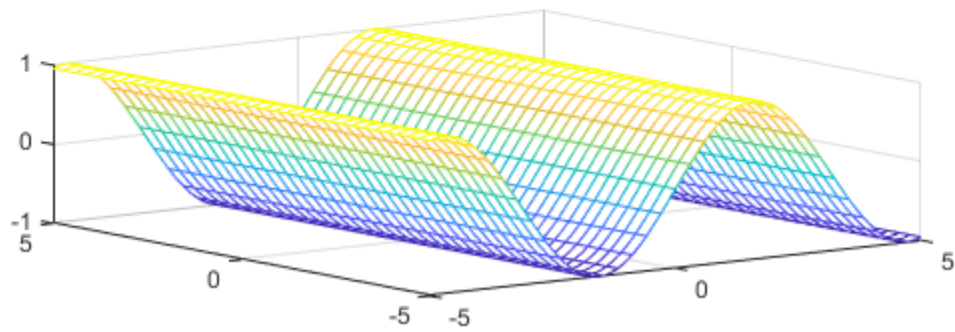
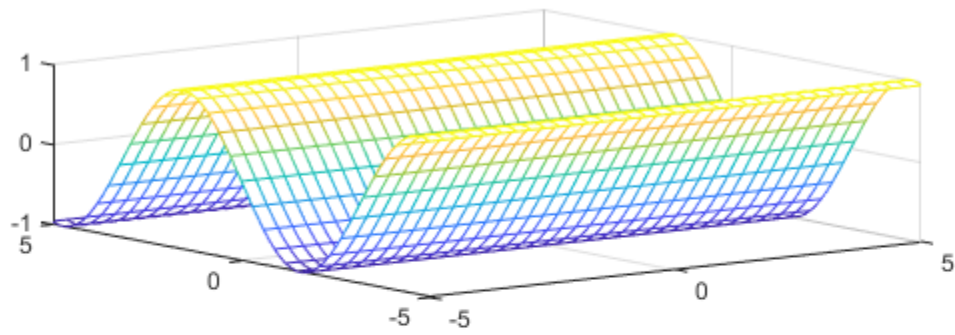

See Also

Functions

`fcontour` | `fimplicit` | `fimplicit3` | `fplot` | `fplot3` | `fsurf`

Properties

Function Surface | Parameterized Function Surface

Topics

“Create Plots” on page 2-229

Introduced in R2016a

fold

Combine (fold) vector using function

Syntax

```
fold(fun,v)
fold(fun,v,defaultVal)
```

Description

`fold(fun,v)` folds `v` by using `fun`. That is, `fold` calls `fun` on the first two elements of `v`, and then repeatedly calls `fun` on the result and the next element till the last element is combined. Programmatically, the fold operation is `fold(fun,v) = fun(fold(fun,v(1:end-1)),v(end))`.

`fold(fun,v,defaultVal)` returns the value `defaultVal` if `v` is empty.

Examples

Fold Vector Using Function

Fold a vector of symbolic variables using the power function. The output shows how `fold` combines elements of the vector from left to right by using the specified function.

```
syms a b c d e
fold(@power, [a b c d e])
```

```
ans =
((a^b)^c)^d)^e
```

Assume Variable Belongs to Set of Values

Assume the variable `x` belongs to the set of values 1, 2, ..., 10 by applying `or` to the conditions `x == 1, ..., x == 10` using `fold`. Check that the assumption is set by using `assumptions`.

```
syms x
cond = fold(@or, x == 1:10);
assume(cond)
assumptions
```

```
ans =
x == 1 | x == 2 | x == 3 | x == 4 | x == 5 | ...
x == 6 | x == 7 | x == 8 | x == 9 | x == 10
```

Specify Default Value of Fold Operation

Specify the default value of `fold` when the input is empty by specifying the third argument. If the third argument is not specified and the input is empty, then `fold` throws an error.

When creating a function to sum a vector, specify a default value of `0`, such that the function returns `0` when the vector is empty.

```
sumVector = @(x) fold(@plus, x, 0);  
sumVector([])
```

```
ans =  
    0
```

Input Arguments

fun — Function used to fold vector

function handle

Function used to fold vector, specified as a function handle.

Example: @or

v — Vector to fold

vector | symbolic vector | cell vector

Vector to fold, specified as a vector, symbolic vector, or cell vector. If an element of **v** is a symbolic function, then the formula of the symbolic function is used by calling `formula`.

defaultVal — Default value of fold operation

number | vector | matrix | multidimensional array | symbolic number | symbolic variable | symbolic vector | symbolic matrix | symbolic multidimensional array | symbolic function | symbolic expression

Default value of fold operation, specified as a number, vector, matrix, or multidimensional array, or a symbolic number, variable, vector, matrix, multidimensional array, function, or expression.

See Also

prod | sum

Introduced in R2016b

formula

Return body of symbolic function

Syntax

```
formula(f)
```

Description

`formula(f)` returns the body, or definition, of the symbolic function `f`.

Examples

Return Body of Symbolic Function

Return the body, or definition, of a symbolic function by using `formula`.

```
syms x y
f(x,y) = x + y;
formula(f)
```

```
ans =
x + y
```

If the symbolic function does not have a definition, `formula` returns the symbolic function.

```
syms g(x,y)
formula(g)
```

```
ans =
g(x, y)
```

Input Arguments

f — Input

symbolic function

Input specified as a symbolic function.

See Also

`argnames` | `sym` | `syms` | `symvar`

Introduced in R2012a

fortran

Fortran representation of symbolic expression

Syntax

```
fortran(f)
fortran(f,Name,Value)
```

Description

`fortran(f)` returns Fortran code for the symbolic expression `f`.

`fortran(f,Name,Value)` uses additional options specified by one or more `Name,Value` pair arguments.

Examples

Generate Fortran Code from Symbolic Expression

Generate Fortran code from the symbolic expression $\log(1+x)$.

```
syms x
f = log(1+x);
fortran(f)

ans =
'      t0 = log(x+1.0D0)'
```

Generate Fortran code for the 3-by-3 Hilbert matrix.

```
H = sym(hilb(3));
fortran(H)

ans =
'      H(1,1) = 1.0D0
      H(1,2) = 1.0D0/2.0D0
      H(1,3) = 1.0D0/3.0D0
      H(2,1) = 1.0D0/2.0D0
      H(2,2) = 1.0D0/3.0D0
      H(2,3) = 1.0D0/4.0D0
      H(3,1) = 1.0D0/3.0D0
      H(3,2) = 1.0D0/4.0D0
      H(3,3) = 1.0D0/5.0D0'
```

Write Fortran Code to File with Comments

Write generated Fortran code to a file by specifying the `File` option. When writing to a file, `fortran` optimizes the code using intermediate variables named `t0`, `t1`, Include comments in the file by using the `Comments` option.

```
syms x
f = diff(tan(x));
fortran(f, 'File', 'fortrantest')
```

```
t0 = tan(x)**2+1.0D0
```

Include the comment `Version: 1.1`. Comment lines must be shorter than 71 characters to conform with Fortran 77.

```
fortran(f, 'File', 'fortrantest', 'Comments', 'Version: 1.1')
```

```
*Version: 1.1
t0 = tan(x)**2+1.0D0
```

Input Arguments

f — Symbolic input

symbolic expression

Symbolic input, specified as a symbolic expression.

Name-Value Pair Arguments

Specify optional comma-separated pairs of `Name`, `Value` arguments. `Name` is the argument name and `Value` is the corresponding value. `Name` must appear inside quotes. You can specify several name and value pair arguments in any order as `Name1, Value1, ..., NameN, ValueN`.

Example: `fortran(x^2, 'File', 'fortrancode', 'Comments', 'V1.2')`

File — File to write to

character vector | string

File to write to, specified as a character vector or string. When writing to a file, `fortran` optimizes the code using intermediate variables named `t0`, `t1`,

Comments — Comments to include in file header

character vector | cell array of character vectors | string vector

Comments to include in the file header, specified as a character vector, cell array of character vectors, or string vector. Comment lines must be shorter than 71 characters to conform with Fortran 77.

Tips

- MATLAB is left-associative while Fortran is right-associative. If ambiguity exists in an expression, the `fortran` function must follow MATLAB to create an equivalent representation. For example, `fortran` represents a^b^c in MATLAB as $(a**b)**c$ in Fortran.

See Also

`ccode` | `latex` | `matlabFunction`

Introduced before R2006a

fourier

Fourier transform

Syntax

```
fourier(f)
fourier(f,transVar)
fourier(f,var,transVar)
```

Description

`fourier(f)` returns the “Fourier Transform” on page 4-562 of `f`. By default, the function `symvar` determines the independent variable, and `w` is the transformation variable.

`fourier(f,transVar)` uses the transformation variable `transVar` instead of `w`.

`fourier(f,var,transVar)` uses the independent variable `var` and the transformation variable `transVar` instead of `symvar` and `w`, respectively.

Examples

Fourier Transform of Common Inputs

Compute the Fourier transform of common inputs. By default, the transform is in terms of `w`.

Function	Input and Output
Rectangular pulse	<pre>syms a b t f = rectangularPulse(a,b,t); f_FT = fourier(f)</pre> $f_{FT} = \frac{-(\sin(a*w) + \cos(a*w)*1i)/w + (\sin(b*w) + \cos(b*w)*1i)/w}{w}$
Unit impulse (Dirac delta)	<pre>f = dirac(t); f_FT = fourier(f)</pre> $f_{FT} = 1$
Absolute value	<pre>f = a*abs(t); f_FT = fourier(f)</pre> $f_{FT} = -(2*a)/w^2$
Step (Heaviside)	<pre>f = heaviside(t); f_FT = fourier(f)</pre> $f_{FT} = \pi*i*\text{dirac}(w) - 1i/w$

Function	Input and Output
Constant	<pre>f = a; f_FT = fourier(a) f_FT = pi*dirac(1, w)*2i</pre>
Cosine	<pre>f = a*cos(b*t); f_FT = fourier(f) f_FT = pi*a*(dirac(b + w) + dirac(b - w))</pre>
Sine	<pre>f = a*sin(b*t); f_FT = fourier(f) f_FT = pi*a*(dirac(b + w) - dirac(b - w))*1i</pre>
Sign	<pre>f = sign(t); f_FT = fourier(f) f_FT = -2i/w</pre>
Triangle	<pre>syms c f = triangularPulse(a,b,c,t); f_FT = fourier(f) f_FT = -(a*exp(-b*w*1i) - b*exp(-a*w*1i) - a*exp(-c*w*1i) + ... c*exp(-a*w*1i) + b*exp(-c*w*1i) - c*exp(-b*w*1i))/ ... (w^2*(a - b)*(b - c))</pre>
Right-sided exponential	<p>Also calculate transform with condition $a > 0$. Clear assumptions.</p> <pre>f = exp(-t*abs(a))*heaviside(t); f_FT = fourier(f) assume(a > 0) f_FT_condition = fourier(f) assume(a,'clear') f_FT = 1/(abs(a) + w*1i) - (sign(abs(a))/2 - 1/2)*fourier(exp(-t*abs(a)),t,w) f_FT_condition = 1/(a + w*1i)</pre>
Double-sided exponential	<p>Assume $a > 0$. Clear assumptions.</p> <pre>assume(a > 0) f = exp(-a*t^2); f_FT = fourier(f) assume(a,'clear') f_FT = (pi^(1/2)*exp(-w^2/(4*a)))/a^(1/2)</pre>

Function	Input and Output
Gaussian	<p>Assume b and c are real. Simplify result and clear assumptions.</p> <pre> assume([b c], 'real') f = a*exp(-(t-b)^2/(2*c^2)); f_FT = fourier(f) f_FT_simplify = simplify(f_FT) assume([b c], 'clear') f_FT = (a*pi^(1/2)*exp(-(c^2*(w + (b*1i)/c^2)^2)/2 - b^2/(2*c^2)))/ ... (1/(2*c^2))^(1/2) f_FT_simplify = 2^(1/2)*a*pi^(1/2)*exp(-(w*(w*c^2 + b*2i))/2)*abs(c) </pre>
Bessel of first kind with $\nu = 1$	<p>Simplify the result.</p> <pre> syms x f = besselj(1,x); f_FT = fourier(f); f_FT = simplify(f_FT) f_FT = (2*w*(heaviside(w - 1)*1i - heaviside(w + 1)*1i))/(1 - w^2)^(1/2) </pre>

Specify Independent Variable and Transformation Variable

Compute the Fourier transform of $\exp(-t^2 - x^2)$. By default, `symvar` determines the independent variable, and w is the transformation variable. Here, `symvar` chooses x .

```

syms t x
f = exp(-t^2-x^2);
fourier(f)

ans =
pi^(1/2)*exp(- t^2 - w^2/4)

```

Specify the transformation variable as y . If you specify only one variable, that variable is the transformation variable. `symvar` still determines the independent variable.

```

syms y
fourier(f,y)

ans =
pi^(1/2)*exp(- t^2 - y^2/4)

```

Specify both the independent and transformation variables as t and y in the second and third arguments, respectively.

```

fourier(f,t,y)

ans =
pi^(1/2)*exp(- x^2 - y^2/4)

```

Fourier Transforms Involving Dirac and Heaviside Functions

Compute the following Fourier transforms. The results are in terms of the Dirac and Heaviside functions.

```
syms t w
fourier(t^3, t, w)
```

```
ans =
-pi*dirac(3, w)*2i
```

```
syms t0
fourier heaviside(t - t0), t, w)
```

```
ans =
exp(-t0*w*1i)*(pi*dirac(w) - 1i/w)
```

Specify Fourier Transform Parameters

Specify parameters of the Fourier transform.

Compute the Fourier transform of f using the default values of the Fourier parameters $c = 1$, $s = -1$. For details, see “Fourier Transform” on page 4-562.

```
syms t w
f = t*exp(-t^2);
fourier(f, t, w)
```

```
ans =
-(w*pi^(1/2)*exp(-w^2/4)*1i)/2
```

Change the Fourier parameters to $c = 1$, $s = 1$ by using `sympref`, and compute the transform again. The result changes.

```
sympref('FourierParameters', [1 1]);
fourier(f, t, w)
```

```
ans =
(w*pi^(1/2)*exp(-w^2/4)*1i)/2
```

Change the Fourier parameters to $c = 1/(2\pi)$, $s = 1$. The result changes.

```
sympref('FourierParameters', [1/(2*sym(pi)), 1]);
fourier(f, t, w)
```

```
ans =
(w*exp(-w^2/4)*1i)/(4*pi^(1/2))
```

Preferences set by `sympref` persist through your current and future MATLAB sessions. Restore the default values of c and s by setting `FourierParameters` to `'default'`.

```
sympref('FourierParameters', 'default');
```

Fourier Transform of Array Inputs

Find the Fourier transform of the matrix M . Specify the independent and transformation variables for each matrix entry by using matrices of the same size. When the arguments are nonscalars, `fourier` acts on them element-wise.

```
syms a b c d w x y z
M = [exp(x) 1; sin(y) i*z];
vars = [w x; y z];
transVars = [a b; c d];
fourier(M, vars, transVars)
```

```
ans =
 [ 2*pi*exp(x)*dirac(a), 2*pi*dirac(b)]
 [ -pi*(dirac(c - 1) - dirac(c + 1))*1i, -2*pi*dirac(1, d)]
```

If `fourier` is called with both scalar and nonscalar arguments, then it expands the scalars to match the nonscalars by using scalar expansion. Nonscalar arguments must be the same size.

```
fourier(x,vars,transVars)
```

```
ans =
 [ 2*pi*x*dirac(a), pi*dirac(1, b)*2i]
 [ 2*pi*x*dirac(c), 2*pi*x*dirac(d)]
```

If Fourier Transform Cannot Be Found

If `fourier` cannot transform the input then it returns an unevaluated call.

```
syms f(t) w
F = fourier(f,t,w)
```

```
F =
fourier(f(t), t, w)
```

Return the original expression by using `ifourier`.

```
ifourier(F,w,t)
```

```
ans =
f(t)
```

Input Arguments

f — Input

symbolic expression | symbolic function | symbolic vector | symbolic matrix

Input, specified as a symbolic expression, function, vector, or matrix.

var — Independent variable

x (default) | symbolic variable

Independent variable, specified as a symbolic variable. This variable is often called the "time variable" or the "space variable." If you do not specify the variable, then `fourier` uses the function `symvar` to determine the independent variable.

transVar — Transformation variable

w (default) | v | symbolic variable | symbolic expression | symbolic vector | symbolic matrix

Transformation variable, specified as a symbolic variable, expression, vector, or matrix. This variable is often called the "frequency variable." By default, `fourier` uses `w`. If `w` is the independent variable of `f`, then `fourier` uses `v`.

More About

Fourier Transform

The Fourier transform of the expression $f = f(x)$ with respect to the variable `x` at the point `w` is

$$F(w) = c \int_{-\infty}^{\infty} f(x)e^{iswx}dx.$$

c and s are parameters of the Fourier transform. The `fourier` function uses $c = 1$, $s = -1$.

Tips

- If any argument is an array, then `fourier` acts element-wise on all elements of the array.
- If the first argument contains a symbolic function, then the second argument must be a scalar.
- To compute the inverse Fourier transform, use `ifourier`.
- `fourier` does not transform piecewise. Instead, try to rewrite piecewise by using the functions `heaviside`, `rectangularPulse`, or `triangularPulse`.

References

- [1] Oberhettinger F, "Tables of Fourier Transforms and Fourier Transforms of Distributions." Springer, 1990.

See Also

`ifourier` | `ilaplace` | `iztrans` | `laplace` | `sympref` | `ztrans`

Topics

"Fourier and Inverse Fourier Transforms" on page 2-214

Introduced before R2006a

fplot

Plot symbolic expression or function

Syntax

```
fplot(f)
fplot(f,[xmin xmax])

fplot(xt,yt)
fplot(xt,yt,[tmin tmax])

fplot( ____,LineStyle)
fplot( ____,Name,Value)
fplot(ax, ____)
fp = fplot( ____)
```

Description

`fplot(f)` plots symbolic input `f` over the default interval `[-5 5]`.

`fplot(f,[xmin xmax])` plots `f` over the interval `[xmin xmax]`.

`fplot(xt,yt)` plots $xt = x(t)$ and $yt = y(t)$ over the default range of `t`, which is `[-5 5]`.

`fplot(xt,yt,[tmin tmax])` plots $xt = x(t)$ and $yt = y(t)$ over the specified range `[tmin tmax]`.

`fplot(____,LineStyle)` uses `LineStyle` to set the line style, marker symbol, and line color.

`fplot(____,Name,Value)` specifies line properties using one or more `Name,Value` pair arguments. Use this option with any of the input argument combinations in the previous syntaxes. `Name,Value` pair settings apply to all the lines plotted. To set options for individual lines, use the objects returned by `fplot`.

`fplot(ax, ____)` plots into the axes specified by `ax` instead of the current axes `gca`.

`fp = fplot(____)` returns a function line object or parameterized line object, depending on the type of plot. Use the object to query and modify properties of a specific line. For details, see [Function Line](#) and [Parameterized Function Line](#).

Examples

Plot Symbolic Expression

Plot $\tan(x)$ over the default range of `[-5 5]`. `fplot` shows poles by default. For details, see the `ShowPoles` argument in “Name-Value Pair Arguments” on page 4-578.

```
syms x
fplot(tan(x))
```

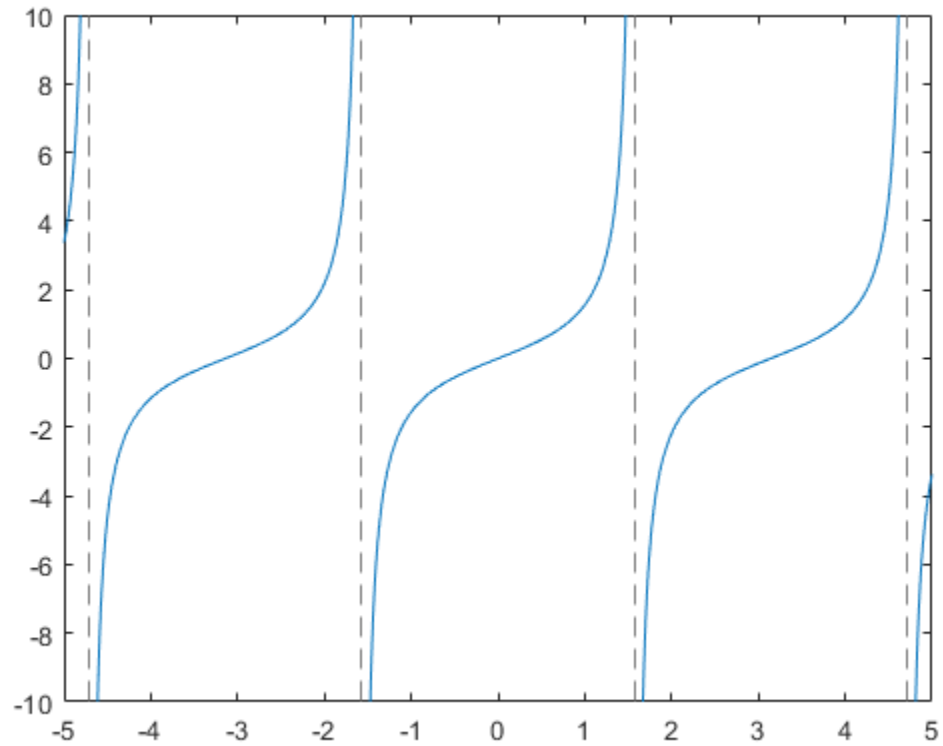

Plot Symbolic Function

Plot the symbolic function $f(x) = \cos(x)$ over the default range $[-5 \ 5]$.

```
syms f(x)
f(x) = cos(x);
fplot(f)
```

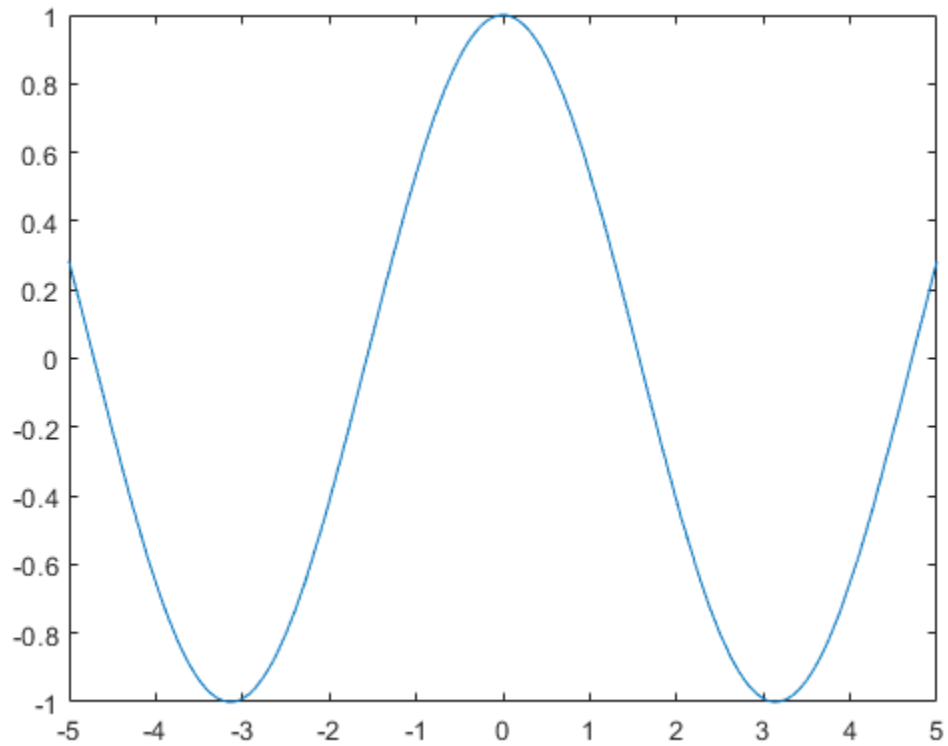

Plot Parametric Curve

Plot the parametric curve $x = \cos(3t)$ and $y = \sin(2t)$.

```
syms t
x = cos(3*t);
y = sin(2*t);
fplot(x,y)
```

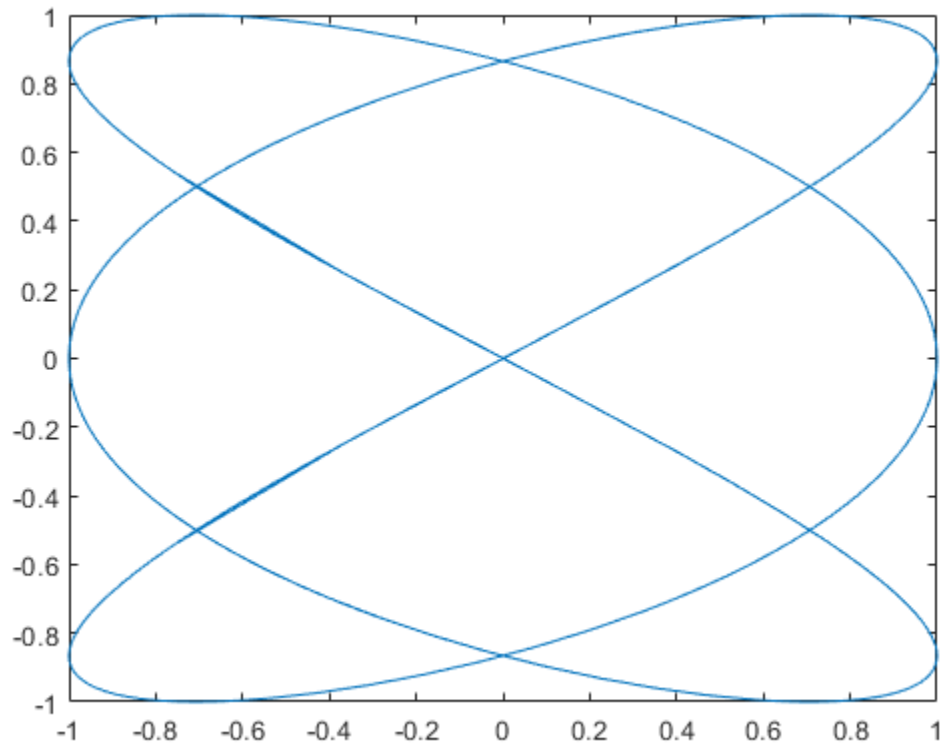

Specify Plotting Interval

Plot $\sin(x)$ over $[-\pi/2, \pi/2]$ by specifying the plotting interval as the second input to `fplot`.

```
syms x  
fplot(sin(x),[-pi/2 pi/2])
```

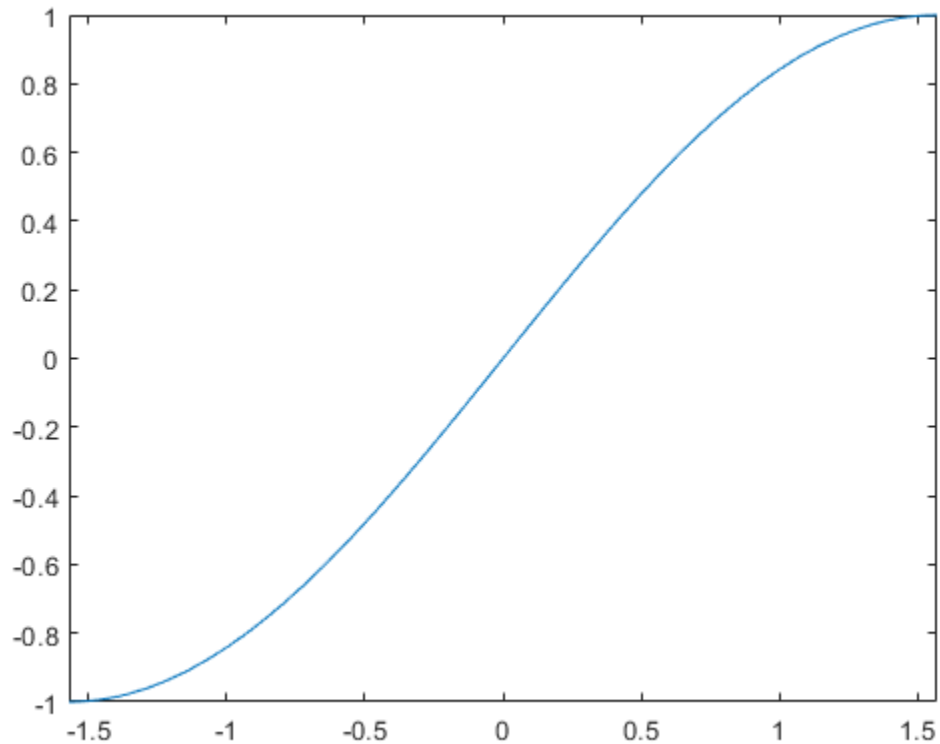

Plot Multiple Lines on Same Figure

You can plot multiple lines either by passing the inputs as a vector or by using `hold on` to successively plot on the same figure. If you specify `LineStyle` and Name-Value arguments, they apply to all lines. To set options for individual plots, use the function handles returned by `fplot`.

Divide a figure into two subplots using `subplot`. On the first subplot, plot $\sin(x)$ and $\cos(x)$ using vector input. On the second subplot, plot $\sin(x)$ and $\cos(x)$ using `hold on`.

```
syms x
subplot(2,1,1)
fplot([sin(x) cos(x)])
title('Multiple Lines Using Vector Inputs')

subplot(2,1,2)
fplot(sin(x))
hold on
fplot(cos(x))
title('Multiple Lines Using hold on Command')

hold off
```

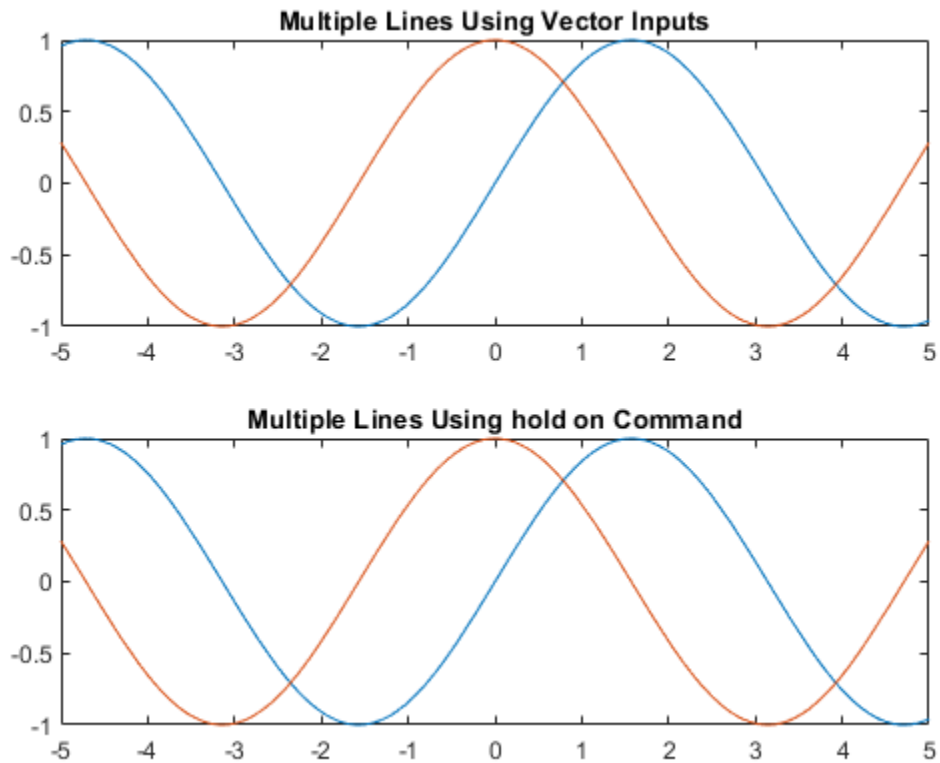

Change Line Properties and Display Markers

Plot three sine curves with a phase shift between each line. For the first line, use a linewidth of 2. For the second, specify a dashed red line style with circle markers. For the third, specify a cyan, dash-dot line style with asterisk markers. Display the legend.

```
syms x
fplot(sin(x+pi/5),'Linewidth',2)
hold on
fplot(sin(x-pi/5),'--or')
fplot(sin(x),'-.*c')
legend('show','Location','best')
hold off
```

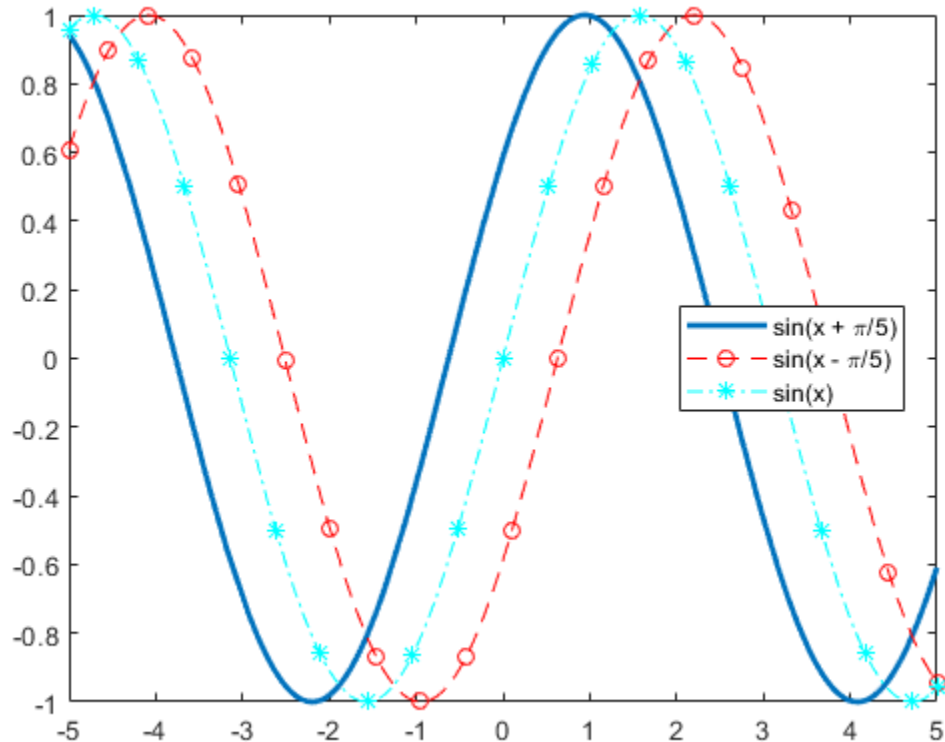

Control Resolution of Plot

Control the resolution of a plot by using the `MeshDensity` option. Increasing `MeshDensity` can make smoother, more accurate plots, while decreasing it can increase plotting speed.

Divide a figure into two by using `subplot`. In the first subplot, plot a step function from $x = 2.1$ to $x = 2.15$. The plot's resolution is too low to detect the step function. Fix this issue by increasing `MeshDensity` to 39 in the second subplot. The plot now detects the step function and shows that by increasing `MeshDensity` you increased the plot's resolution.

```
syms x
stepFn = rectangularPulse(2.1, 2.15, x);

subplot(2,1,1)
fplot(stepFn);
title('Default MeshDensity = 23')

subplot(2,1,2)
fplot(stepFn, 'MeshDensity', 39);
title('Increased MeshDensity = 39')
```

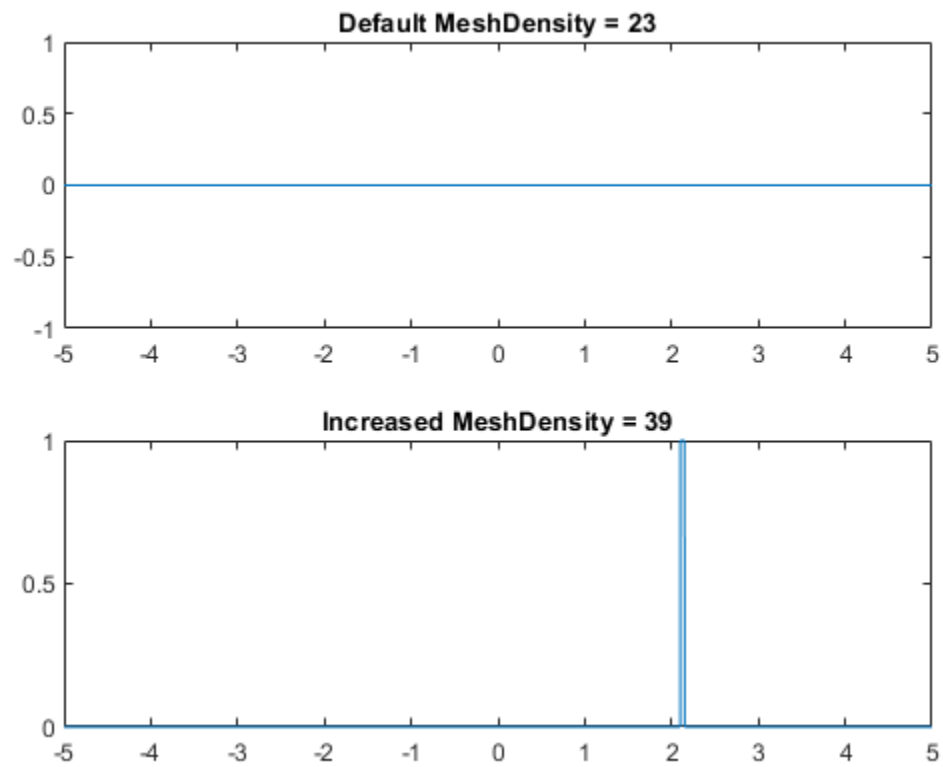
Modify Plot After Creation

Plot $\sin(x)$. Specify an output to make `fplot` return the plot object.

```
syms x  
h = fplot(sin(x))
```

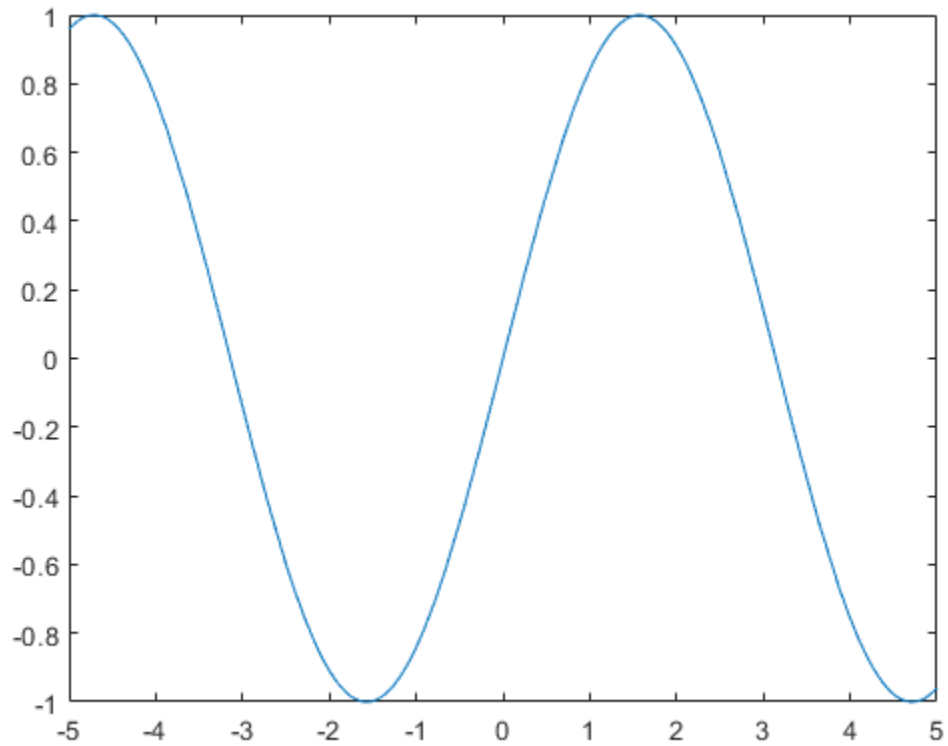

```
h =  
FunctionLine with properties:  
  
    Function: [1x1 sym]  
      Color: [0 0.4470 0.7410]  
LineStyle: '-'  
  LineWidth: 0.5000  
  
Show all properties
```

Change the default blue line to a dashed red line by using dot notation to set properties. Similarly, add 'x' markers and set the marker color to blue.

```
h.LineStyle = '--';  
h.Color = 'r';  
h.Marker = 'x';  
h.MarkerEdgeColor = 'b';
```

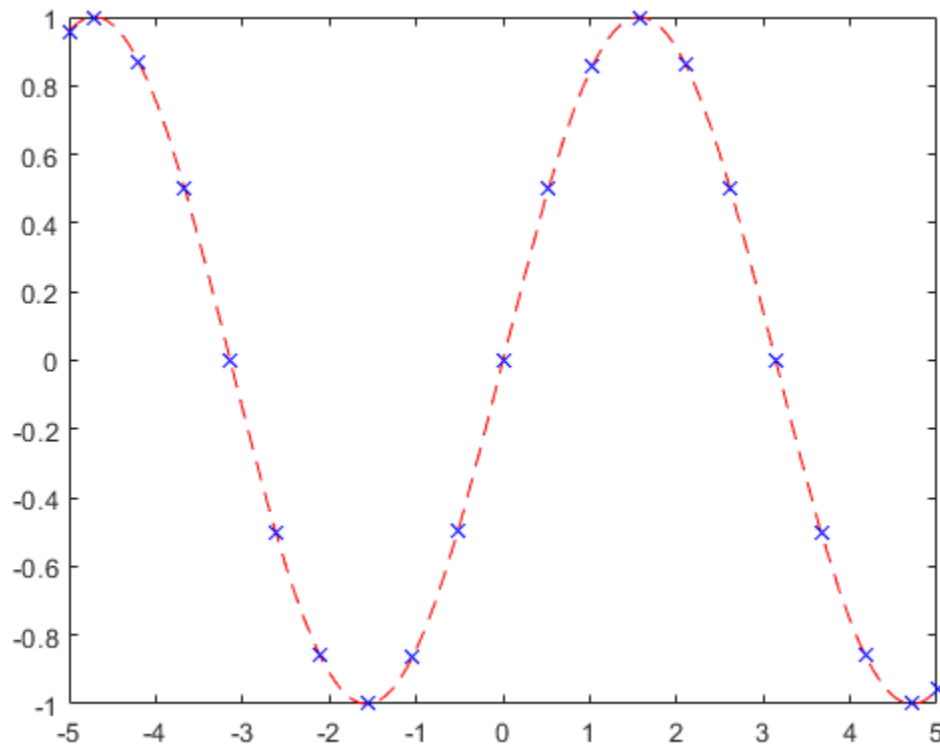

Add Title and Axis Labels and Format Ticks

For x from -2π to 2π , plot $\sin(x)$. Add a title and axis labels. Create the x-axis ticks by spanning the x-axis limits at intervals of $\pi/2$. Display these ticks by using the `XTick` property. Create x-axis labels by using `arrayfun` to apply `texlabel` to `S`. Display these labels by using the `XTickLabel` property.

To use LaTeX in plots, see `latex`.

```
syms x
fplot(sin(x),[-2*pi 2*pi])
grid on
title('sin(x) from -2\pi to 2\pi')
xlabel('x')
ylabel('y')

ax = gca;
S = sym(ax.XLim(1):pi/2:ax.XLim(2));
ax.XTick = double(S);
ax.XTickLabel = arrayfun(@texlabel,S,'UniformOutput',false);
```

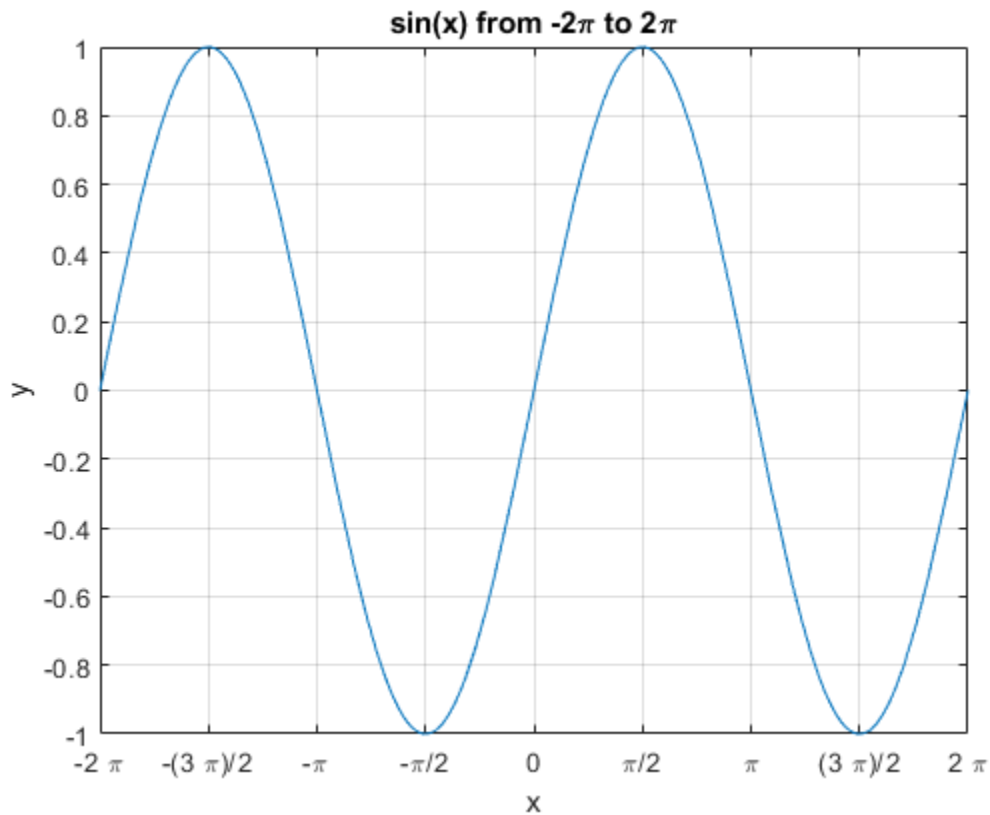

Re-evaluation on Zoom

When you zoom into a plot, `fplot` re-evaluates the plot automatically. This re-evaluation on zoom reveals hidden detail at smaller scales.

Plot $x^3 \sin(1/x)$ for $-2 < x < 2$ and $-0.02 < y < 0.02$. Zoom in on the plot using `zoom` and redraw the plot using `drawnow`. Because of re-evaluation on zoom, `fplot` reveals smaller-scale detail. Repeat the zoom 6 times to view smaller-scale details. To play the animation, click the image.

```
syms x
fplot(x^3*sin(1/x));
axis([-2 2 -0.02 0.02]);
for i=1:6
    zoom(1.7)
    pause(0.5)
end
```

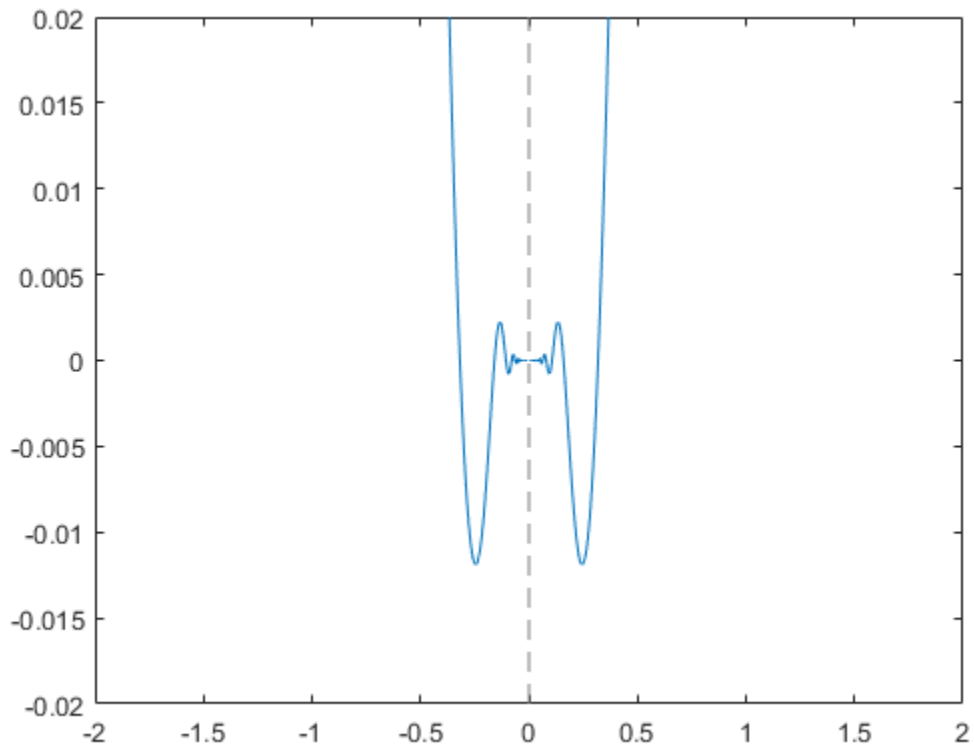

Create Animations

Create animations by changing the displayed expression using the `Function`, `XFunction`, and `YFunction` properties and then by using `drawnow` to update the plot. To export to GIF, see `imwrite`.

By varying the variable i from 0.1 to 3, animate the parametric curve

$$x = it\sin(it)$$

$$y = it\cos(it).$$

To play the animation, click the image.

```
syms t
fp = fplot(t, t);
axis([-15 15 -15 15])
for i=0.1:0.05:3
    fp.XFunction = i.*t.*sin(i*t);
    fp.YFunction = i.*t.*cos(i*t);
    drawnow
end
```

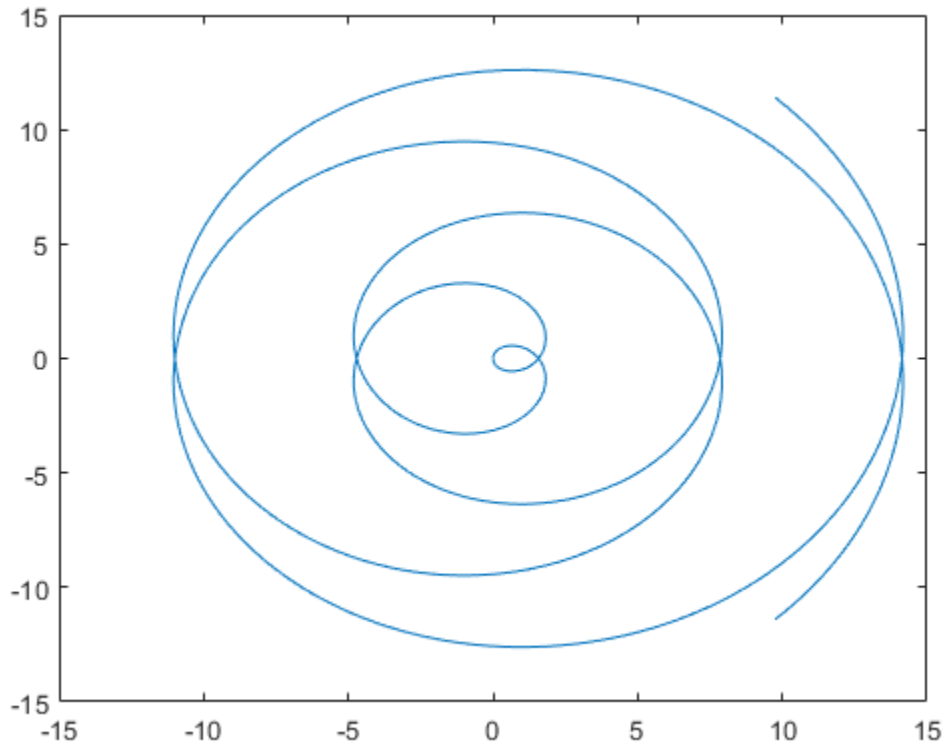

Input Arguments

f — Expression or function to plot

symbolic expression | symbolic function

Expression or function to plot, specified as a symbolic expression or function.

[xmin xmax] — Plotting interval for x-coordinates

[-5 5] (default) | vector of two numbers

Plotting interval for x-coordinates, specified as a vector of two numbers. The default range is [-5 5]. However, if `fplot` detects a finite number of discontinuities in `f`, then `fplot` expands the range to show them.

xt — Parametric input for x-coordinates

symbolic expression | symbolic function

Parametric input for x-coordinates, specified as a symbolic expression or function. `fplot` uses `symvar` to find the parameter.

yt — Parametric input for y-axis

symbolic expression | symbolic function

Parametric input for y-axis, specified as a symbolic expression or function. `fplot` uses `symvar` to find the parameter.

[tmin tmax] – Range of values of parameter t

[-5 5] (default) | vector of two numbers

Range of values of parameter `t`, specified as a vector of two numbers. The default range is [-5 5].

ax – Axes object

axes object

Axes object. If you do not specify an axes object, then `fplot` uses the current axes `gca`.

LineStyleSpec – Line specification

character vector | string

Line specification, specified as a character vector or string with a line style, marker, and color. The elements can appear in any order, and you can omit one or more options. To show only markers with no connecting lines, specify a marker and omit the line style.

Example: 'r - - o' specifies a red color, a dashed line, and circle markers

Line Style Specifier	Description
-	Solid line (default)
--	Dashed line
:	Dotted line
-. .	Dash-dot line

Marker Specifier	Description
o	Circle
+	Plus sign
*	Asterisk
.	Point
x	Cross
s	Square
d	Diamond
^	Upward-pointing triangle
v	Downward-pointing triangle
>	Right-pointing triangle
<	Left-pointing triangle
p	Pentagram
h	Hexagram

Color Specifier	Description
y	yellow
m	magenta
c	cyan
r	red

Color Specifier	Description
g	green
b	blue
w	white
k	black

Name-Value Pair Arguments

Specify optional comma-separated pairs of `Name`, `Value` arguments. `Name` is the argument name and `Value` is the corresponding value. `Name` must appear inside quotes. You can specify several name and value pair arguments in any order as `Name1, Value1, ..., NameN, ValueN`.

The function line properties listed here are only a subset. For a complete list, see `Function Line`.

Example: `'Marker', 'o', 'MarkerFaceColor', 'red'`

MeshDensity — Number of evaluation points

23 (default) | number

Number of evaluation points, specified as a number. The default is 23. Because `fplot` uses adaptive evaluation, the actual number of evaluation points is greater.

ShowPoles — Display asymptotes at poles

'on' (default) | on/off logical value

Display asymptotes at poles, specified as `'on'` or `'off'`, or as numeric or logical 1 (`true`) or 0 (`false`). A value of `'on'` is equivalent to `true`, and `'off'` is equivalent to `false`. Thus, you can use the value of this property as a logical value. The value is stored as an on/off logical value of type `matlab.lang.OnOffSwitchState`.

The asymptotes display as gray, dashed vertical lines. `fplot` displays asymptotes only with the `fplot(f)` syntax or variants, and not with the `fplot(xt, yt)` syntax.

Color — Line color







[0 0.4470 0.7410] (default) | RGB triplet | hexadecimal color code | 'r' | 'g' | 'b' | ...

Line color, specified as an RGB triplet, a hexadecimal color code, a color name, or a short name.





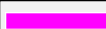
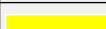

For a custom color, specify an RGB triplet or a hexadecimal color code.

- An RGB triplet is a three-element row vector whose elements specify the intensities of the red, green, and blue components of the color. The intensities must be in the range `[0, 1]`; for example, `[0.4 0.6 0.7]`.
- A hexadecimal color code is a character vector or a string scalar that starts with a hash symbol (`#`) followed by three or six hexadecimal digits, which can range from 0 to F. The values are not case sensitive. Thus, the color codes `'#FF8800'`, `'#ff8800'`, `'#F80'`, and `'#f80'` are equivalent.

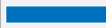
Alternatively, you can specify some common colors by name. This table lists the named color options, the equivalent RGB triplets, and hexadecimal color codes.

Color Name	Short Name	RGB Triplet	Hexadecimal Color Code	Appearance
'red'	'r'	[1 0 0]	'#FF0000'	
'green'	'g'	[0 1 0]	'#00FF00'	
'blue'	'b'	[0 0 1]	'#0000FF'	
'cyan'	'c'	[0 1 1]	'#00FFFF'	
'magenta'	'm'	[1 0 1]	'#FF00FF'	
'yellow'	'y'	[1 1 0]	'#FFFF00'	
'black'	'k'	[0 0 0]	'#000000'	
'white'	'w'	[1 1 1]	'#FFFFFF'	

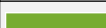
Here are the RGB triplets and hexadecimal color codes for the default colors MATLAB uses in many types of plots.

RGB Triplet	Hexadecimal Color Code	Appearance
[0 0.4470 0.7410]	'#0072BD'	
[0.8500 0.3250 0.0980]	'#D95319'	
[0.9290 0.6940 0.1250]	'#EDB120'	
[0.4940 0.1840 0.5560]	'#7E2F8E'	
[0.4660 0.6740 0.1880]	'#77AC30'	
[0.3010 0.7450 0.9330]	'#4DBEEE'	
[0.6350 0.0780 0.1840]	'#A2142F'	

Example: 'blue'





Example: [0 0 1]

Example: '#0000FF'

LineStyle – Line style

'-' (default) | '--' | ':' | '-.' | 'none'

Line style, specified as one of the options listed in this table.

Line Style	Description	Resulting Line
'-'	Solid line	
'--'	Dashed line	
':'	Dotted line	
'-.'	Dash-dotted line	
'none'	No line	No line

LineWidth – Line width

0.5 (default) | positive value

Line width, specified as a positive value in points, where 1 point = 1/72 of an inch. If the line has markers, then the line width also affects the marker edges.

The line width cannot be thinner than the width of a pixel. If you set the line width to a value that is less than the width of a pixel on your system, the line displays as one pixel wide.

Marker — Marker symbol

'none' (default) | 'o' | '+' | '*' | '.' | 'x' | 's' | 'd' | ...

Marker symbol, specified as one of the values in this table. By default, a line does not have markers. Add markers at selected points along the line by specifying a marker.

Value	Description
'o'	Circle
'+'	Plus sign
'*'	Asterisk
'.'	Point
'x'	Cross
'square' or 's'	Square
'diamond' or 'd'	Diamond
'^'	Upward-pointing triangle
'v'	Downward-pointing triangle
'>'	Right-pointing triangle
'<'	Left-pointing triangle
'pentagram' or 'p'	Five-pointed star (pentagram)
'hexagram' or 'h'	Six-pointed star (hexagram)
'none'	No markers

MarkerEdgeColor — Marker outline color







'auto' (default) | RGB triplet | hexadecimal color code | 'r' | 'g' | 'b' | ...

Marker outline color, specified as 'auto', an RGB triplet, a hexadecimal color code, a color name, or a short name. The default value of 'auto' uses the same color as the Color property.





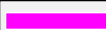
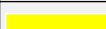

For a custom color, specify an RGB triplet or a hexadecimal color code.

- An RGB triplet is a three-element row vector whose elements specify the intensities of the red, green, and blue components of the color. The intensities must be in the range [0, 1]; for example, [0.4 0.6 0.7].
- A hexadecimal color code is a character vector or a string scalar that starts with a hash symbol (#) followed by three or six hexadecimal digits, which can range from 0 to F. The values are not case sensitive. Thus, the color codes '#FF8800', '#ff8800', '#F80', and '#f80' are equivalent.

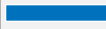
Alternatively, you can specify some common colors by name. This table lists the named color options, the equivalent RGB triplets, and hexadecimal color codes.

Color Name	Short Name	RGB Triplet	Hexadecimal Color Code	Appearance
'red'	'r'	[1 0 0]	'#FF0000'	
'green'	'g'	[0 1 0]	'#00FF00'	
'blue'	'b'	[0 0 1]	'#0000FF'	
'cyan'	'c'	[0 1 1]	'#00FFFF'	
'magenta'	'm'	[1 0 1]	'#FF00FF'	
'yellow'	'y'	[1 1 0]	'#FFFF00'	
'black'	'k'	[0 0 0]	'#000000'	
'white'	'w'	[1 1 1]	'#FFFFFF'	
'none'	Not applicable	Not applicable	Not applicable	No color

Here are the RGB triplets and hexadecimal color codes for the default colors MATLAB uses in many types of plots.

RGB Triplet	Hexadecimal Color Code	Appearance
[0 0.4470 0.7410]	'#0072BD'	
[0.8500 0.3250 0.0980]	'#D95319'	
[0.9290 0.6940 0.1250]	'#EDB120'	
[0.4940 0.1840 0.5560]	'#7E2F8E'	
[0.4660 0.6740 0.1880]	'#77AC30'	
[0.3010 0.7450 0.9330]	'#4DBEEE'	
[0.6350 0.0780 0.1840]	'#A2142F'	

MarkerFaceColor — Marker fill color







'none' (default) | 'auto' | RGB triplet | hexadecimal color code | 'r' | 'g' | 'b' | ...

Marker fill color, specified as 'auto', an RGB triplet, a hexadecimal color code, a color name, or a short name. The 'auto' value uses the same color as the MarkerEdgeColor property.



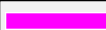
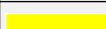

For a custom color, specify an RGB triplet or a hexadecimal color code.

- An RGB triplet is a three-element row vector whose elements specify the intensities of the red, green, and blue components of the color. The intensities must be in the range [0, 1]; for example, [0.4 0.6 0.7].
- A hexadecimal color code is a character vector or a string scalar that starts with a hash symbol (#) followed by three or six hexadecimal digits, which can range from 0 to F. The values are not case sensitive. Thus, the color codes '#FF8800', '#ff8800', '#F80', and '#f80' are equivalent.

Alternatively, you can specify some common colors by name. This table lists the named color options, the equivalent RGB triplets, and hexadecimal color codes.

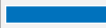
Color Name	Short Name	RGB Triplet	Hexadecimal Color Code	Appearance
'red'	'r'	[1 0 0]	'#FF0000'	
'green'	'g'	[0 1 0]	'#00FF00'	
'blue'	'b'	[0 0 1]	'#0000FF'	
'cyan'	'c'	[0 1 1]	'#00FFFF'	
'magenta'	'm'	[1 0 1]	'#FF00FF'	
'yellow'	'y'	[1 1 0]	'#FFFF00'	
'black'	'k'	[0 0 0]	'#000000'	
'white'	'w'	[1 1 1]	'#FFFFFF'	
'none'	Not applicable	Not applicable	Not applicable	No color

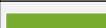
Here are the RGB triplets and hexadecimal color codes for the default colors MATLAB uses in many types of plots.

RGB Triplet	Hexadecimal Color Code	Appearance
[0 0.4470 0.7410]	'#0072BD'	
[0.8500 0.3250 0.0980]	'#D95319'	
[0.9290 0.6940 0.1250]	'#EDB120'	
[0.4940 0.1840 0.5560]	'#7E2F8E'	
[0.4660 0.6740 0.1880]	'#77AC30'	
[0.3010 0.7450 0.9330]	'#4DBEEE'	
[0.6350 0.0780 0.1840]	'#A2142F'	

Example: [0.3 0.2 0.1]

Example: 'green'

Example: '#D2F9A7'

MarkerSize – Marker size

6 (default) | positive value

Marker size, specified as a positive value in points, where 1 point = 1/72 of an inch.

Output Arguments

fp – One or more function or parameterized line objects

scalar | vector

One or more function or parameterized function line objects, returned as a scalar or a vector.

- If you use the `fplot(f)` syntax or a variation of this syntax, then `fplot` returns function line objects.
- If you use the `fplot(xt,yt)` syntax or a variation of this syntax, then `fplot` returns parameterized line objects.

You can use these objects to query and modify properties of a specific line. For a list of properties, see [Function Line](#) and [Parameterized Function Line](#).

Tips

- If `fplot` detects a finite number of discontinuities in `f`, then `fplot` expands the range to show them.

See Also

Functions

[fcontour](#) | [fimplicit](#) | [fimplicit3](#) | [fmesh](#) | [fplot3](#) | [fsurf](#)

Properties

[Function Line](#) | [Parameterized Function Line](#)

Topics

“Create Plots” on page 2-229

Introduced in R2016a

fplot3

Plot 3-D parametric curve

Syntax

```
fplot3(xt,yt,zt)
fplot3(xt,yt,zt,[tmin tmax])
```

```
fplot3( ___,LineStyle)
fplot3( ___,Name,Value)
fplot3(ax, ___)
fp = fplot3( ___)
```

Description

`fplot3(xt,yt,zt)` plots the parametric curve $xt = x(t)$, $yt = y(t)$, and $zt = z(t)$ over the default interval $-5 < t < 5$.

`fplot3(xt,yt,zt,[tmin tmax])` plots $xt = x(t)$, $yt = y(t)$, and $zt = z(t)$ over the interval $tmin < t < tmax$.

`fplot3(___,LineStyle)` uses `LineStyle` to set the line style, marker symbol, and line color.

`fplot3(___,Name,Value)` specifies line properties using one or more `Name,Value` pair arguments. Use this option with any of the input argument combinations in the previous syntaxes. `Name,Value` pair settings apply to all the lines plotted. To set options for individual lines, use the objects returned by `fplot3`.

`fplot3(ax, ___)` plots into the axes object `ax` instead of the current axes `gca`.

`fp = fplot3(___)` returns a parameterized function line object. Use the object to query and modify properties of a specific parameterized line. For details, see [Parameterized Function Line](#).

Examples

Plot 3-D Parametric Line

Plot the 3-D parametric line

$$\begin{aligned}x &= \sin(t) \\ y &= \cos(t) \\ z &= t\end{aligned}$$

over the default parameter range `[-5 5]`.

```
syms t
xt = sin(t);
yt = cos(t);
zt = t;
fplot3(xt,yt,zt)
```

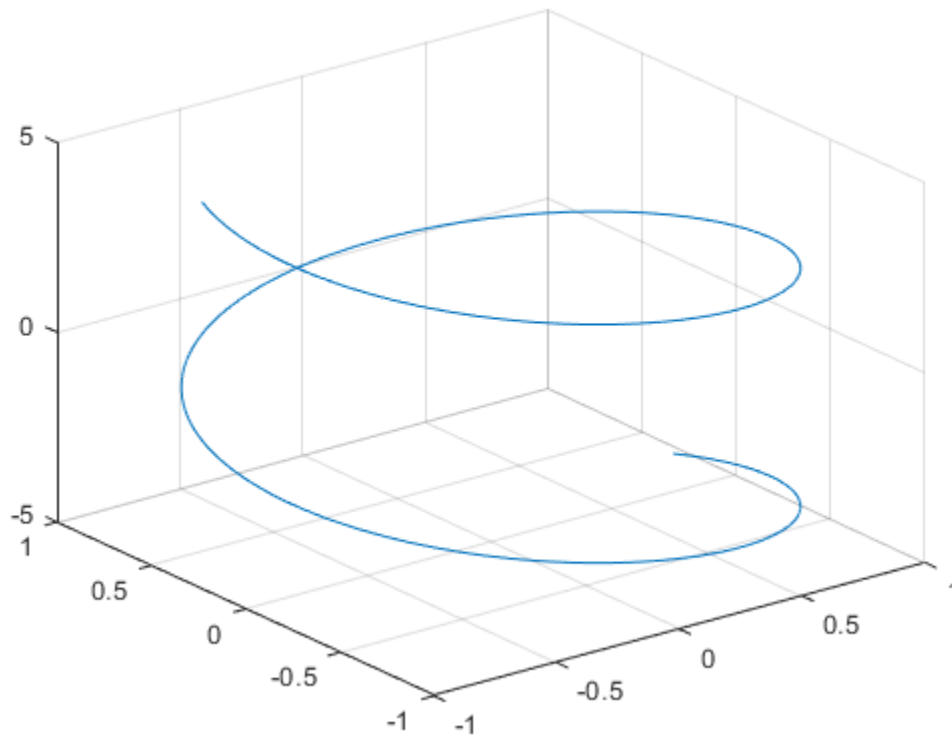

Specify Parameter Range

Plot the parametric line

$$x = e^{-t/10} \sin(5t)$$

$$y = e^{-t/10} \cos(5t)$$

$$z = t$$

over the parameter range $[-10 \ 10]$ by specifying the fourth argument of `fplot3`.

```
syms t
xt = exp(-t/10).*sin(5*t);
yt = exp(-t/10).*cos(5*t);
zt = t;
fplot3(xt,yt,zt,[-10 10])
```

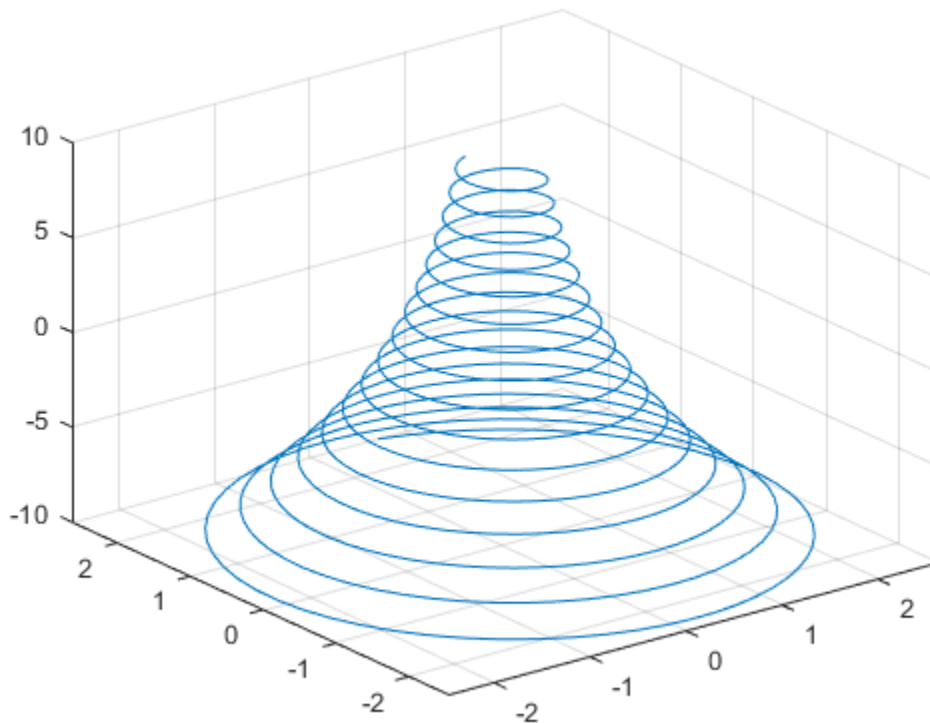

Change Line Properties and Display Markers

Plot the same 3-D parametric curve three times over different intervals of the parameter. For the first curve, use a linewidth of 2. For the second, specify a dashed red line style with circle markers. For the third, specify a cyan, dash-dot line style with asterisk markers.

```
syms t
fplot3(sin(t), cos(t), t, [0 2*pi], 'LineWidth', 2)
hold on
fplot3(sin(t), cos(t), t, [2*pi 4*pi], '--or')
fplot3(sin(t), cos(t), t, [4*pi 6*pi], '-.*c')
```

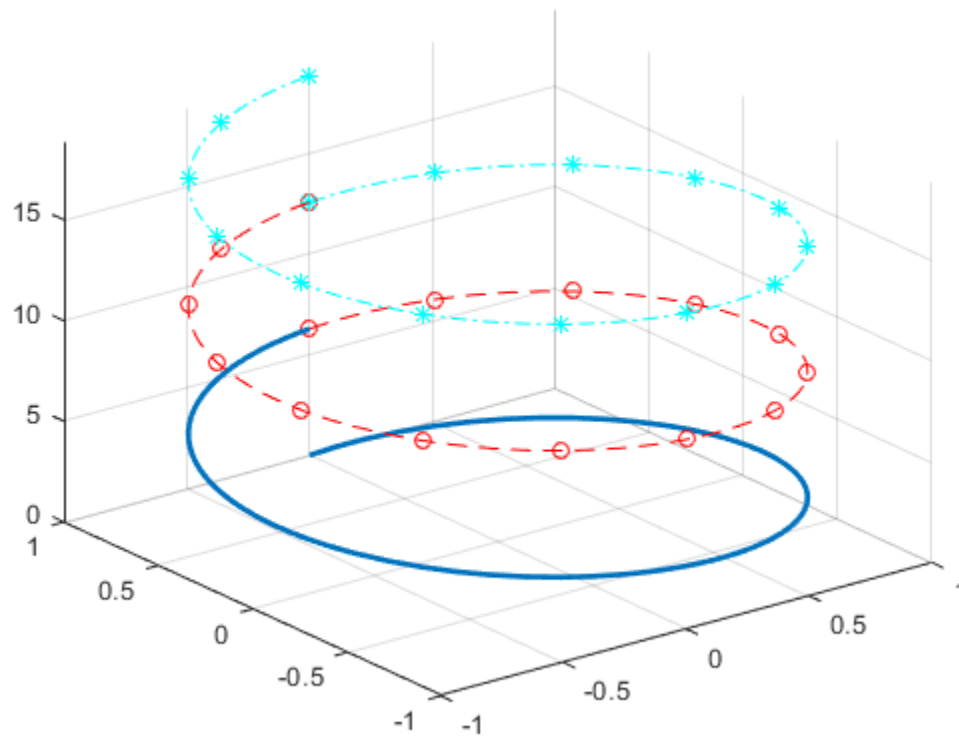
Plot 3-D Parametric Line Using Symbolic Functions

Plot the 3-D parametric line

$$x(t) = \sin(t)$$

$$y(t) = \cos(t)$$

$$z(t) = \cos(2t).$$

```
syms x(t) y(t) z(t)
x(t) = sin(t);
y(t) = cos(t);
z(t) = cos(2*t);
fplot3(x,y,z)
```

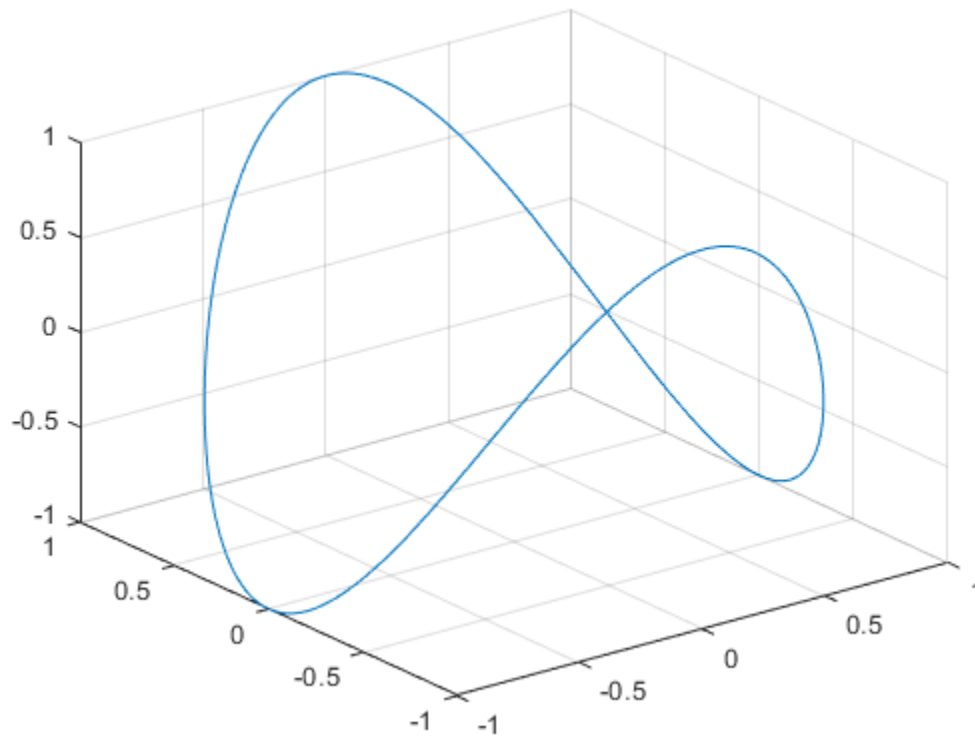

Plot Multiple Lines on Same Figure

Plot multiple lines either by passing the inputs as a vector or by using `hold on` to successively plot on the same figure. If you specify `LineStyle` and Name-Value arguments, they apply to all lines. To set options for individual lines, use the function handles returned by `fplot3`.

Divide a figure into two subplots using `subplot`. On the first subplot, plot two parameterized lines using vector input. On the second subplot, plot the same lines using `hold on`.

```
syms t
subplot(2,1,1)
fplot3([t -t], t, [t -t])
title('Multiple Lines Using Vector Inputs')

subplot(2,1,2)
fplot3(t, t, t)
hold on
fplot3(-t, t, -t)
title('Multiple Lines Using Hold On Command')

hold off
```

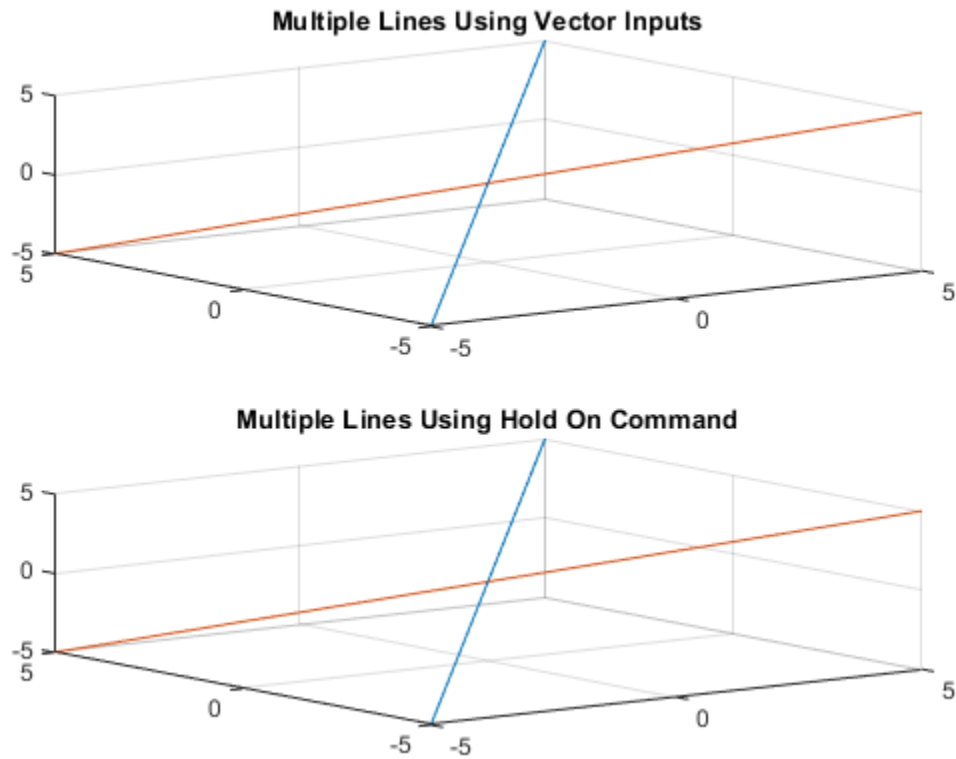

Modify 3-D Parametric Line After Creation

Plot the parametric line

$$x = e^{-|t|/10} \sin(5|t|)$$

$$y = e^{-|t|/10} \cos(5|t|)$$

$$z = t.$$

Provide an output to make `fplot` return the plot object.

```
syms t
xt = exp(-abs(t)/10).*sin(5*abs(t));
yt = exp(-abs(t)/10).*cos(5*abs(t));
zt = t;
fp = fplot3(xt,yt,zt)
```

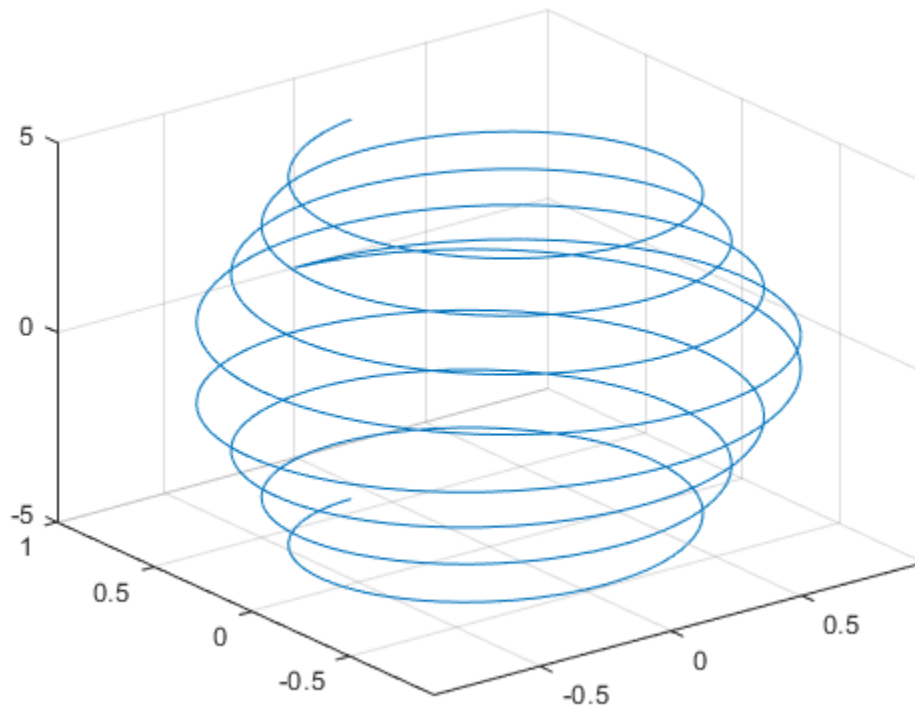

```
fp =  
ParameterizedFunctionLine with properties:  
  
XFunction: [1x1 sym]  
YFunction: [1x1 sym]  
ZFunction: [1x1 sym]  
Color: [0 0.4470 0.7410]  
LineStyle: '-'  
LineWidth: 0.5000
```

Show all properties

Change the range of parameter values to $[-10\ 10]$ and the line color to red by using the `TRange` and `Color` properties of `fp` respectively.

```
fp.TRange = [-10 10];  
fp.Color = 'r';
```

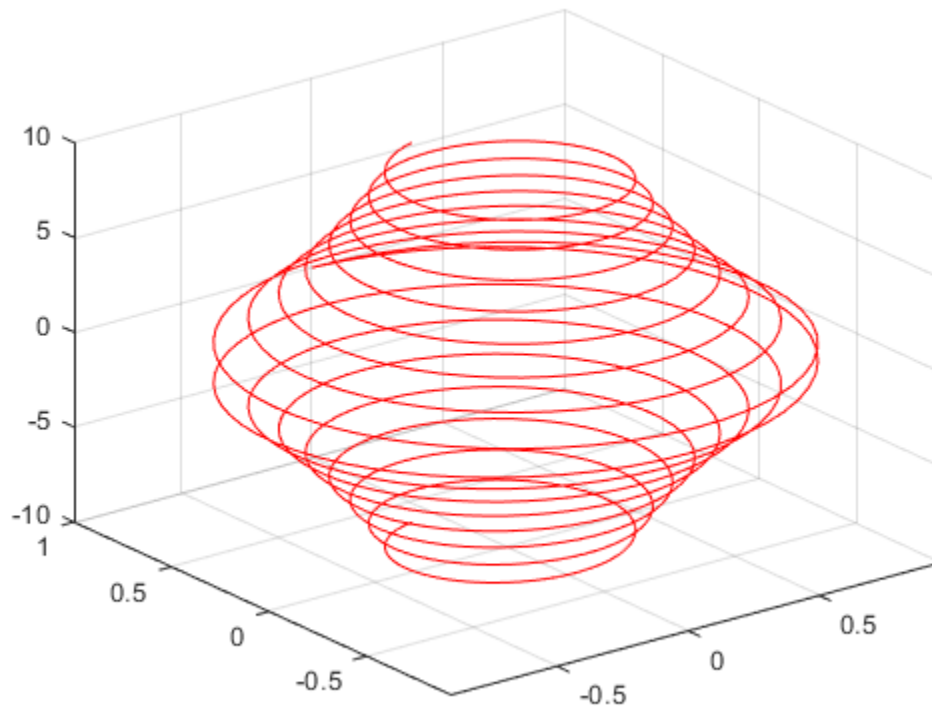

Add Title and Axis Labels and Format Ticks

For t values in the range -2π to 2π , plot the parametric line

$$\begin{aligned}x &= t \\y &= t/2 \\z &= \sin(6t).\end{aligned}$$

Add a title and axis labels. Create the x-axis ticks by spanning the x-axis limits at intervals of $\pi/2$. Display these ticks by using the `XTick` property. Create x-axis labels by using `arrayfun` to apply `textlabel` to `S`. Display these labels by using the `XTickLabel` property. Repeat these steps for the y-axis.

To use LaTeX in plots, see `latex`.

```
syms t
xt = t;
yt = t/2;
zt = sin(6*t);
fplot3(xt,yt,zt,[-2*pi 2*pi], 'MeshDensity',30)
view(52.5,30)
xlabel('x')
ylabel('y')
title('x=t, y=t/2, z=sin(6t) for -2\pi < t < 2\pi')
ax = gca;
```

```

S = sym(ax.XLim(1):pi/2:ax.XLim(2));
ax.XTick = double(S);
ax.XTickLabel = arrayfun(@texlabel, S, 'UniformOutput', false);

S = sym(ax.YLim(1):pi/2:ax.YLim(2));
ax.YTick = double(S);
ax.YTickLabel = arrayfun(@texlabel, S, 'UniformOutput', false);

```

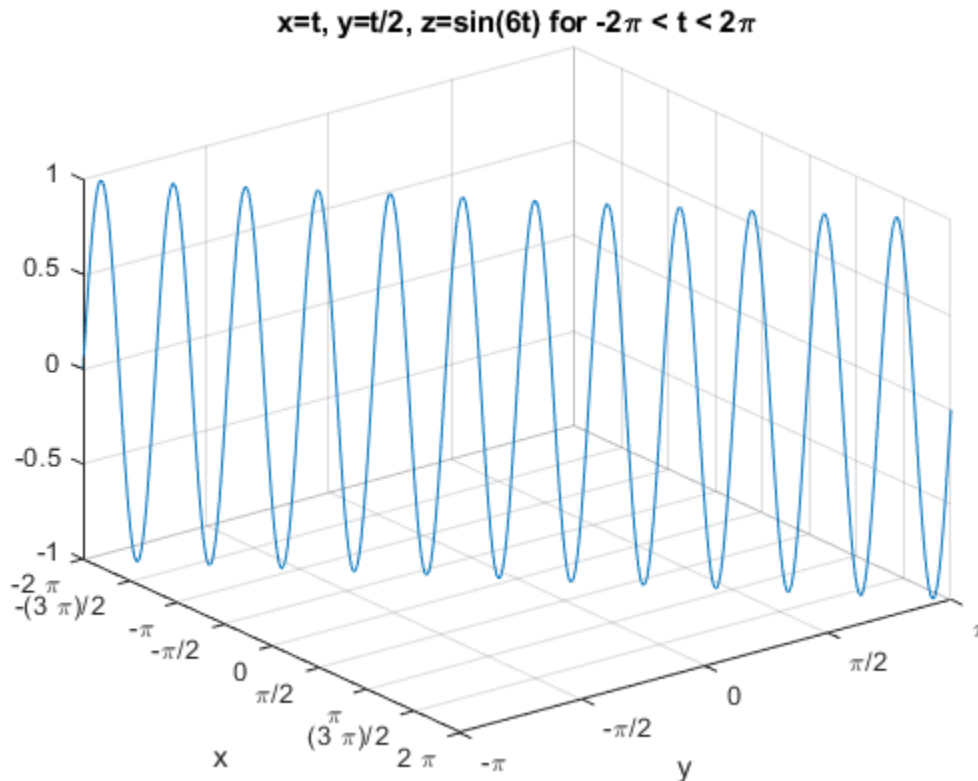

Create Animations

Create animations by changing the displayed expression using the `XFunction`, `YFunction`, and `ZFunction` properties and then by using `drawnow` to update the plot. To export to GIF, see `imwrite`.

By varying the variable i from 0 to 4π , animate the parametric curve

$$\begin{aligned}
 x &= t + \sin(40t) \\
 y &= -t + \cos(40t) \\
 z &= \sin(t + i).
 \end{aligned}$$

To play the animation, click the image.

```

syms t
fp = fplot3(t+sin(40*t), -t+cos(40*t), sin(t));
for i=0:pi/10:4*pi
    fp.ZFunction = sin(t+i);

```

```
drawnow
end
```

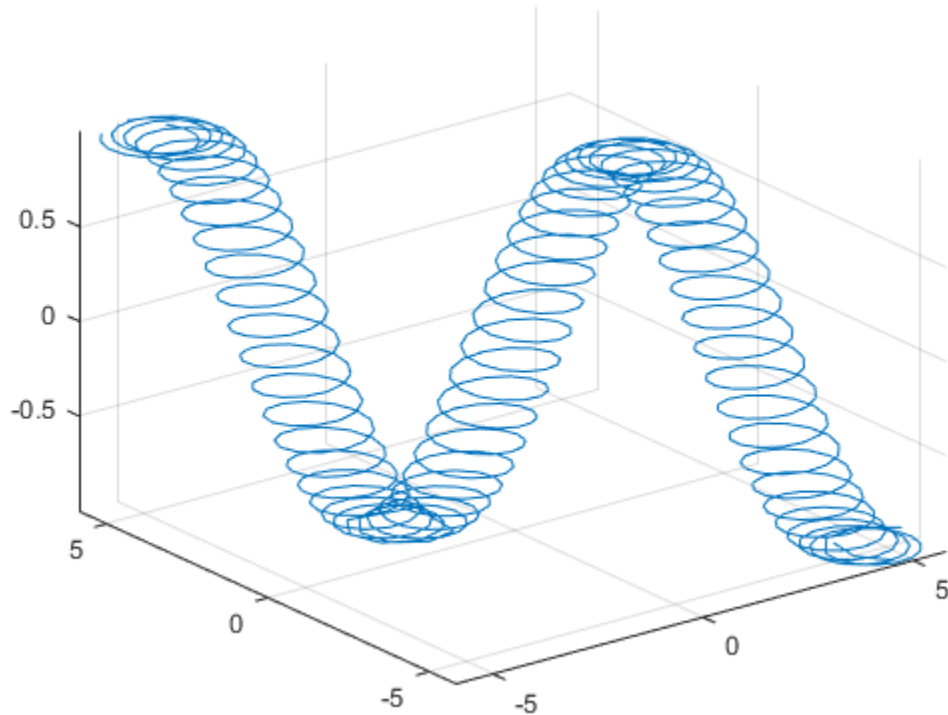

Input Arguments

xt — Parametric input for x-axis

symbolic expression | symbolic function

Parametric input for x-axis, specified as a symbolic expression or function. `fplot3` uses `symvar` to find the parameter.

yt — Parametric input for y-axis

symbolic expression | symbolic function

Parametric input for y-axis, specified as a symbolic expression or function. `fplot3` uses `symvar` to find the parameter.

zt — Parametric input for z-axis

symbolic expression | symbolic function

Parametric input for z-axis, specified as a symbolic expression or function. `fplot3` uses `symvar` to find the parameter.

[tmin tmax] — Range of values of parameter

[-5 5] (default) | vector of two numbers

Range of values of parameter, specified as a vector of two numbers. The default range is [-5 5].

ax — Axes object

axes object

Axes object. If you do not specify an axes object, then `fplot3` uses the current axes.

LineStyle — Line specification

character vector | string

Line specification, specified as a character vector or string with a line style, marker, and color. The elements can appear in any order, and you can omit one or more options. To show only markers with no connecting lines, specify a marker and omit the line style.

Example: 'r--o' specifies a red color, a dashed line, and circle markers

Line Style Specifier	Description
-	Solid line (default)
--	Dashed line
:	Dotted line
-. .	Dash-dot line

Marker Specifier	Description
o	Circle
+	Plus sign
*	Asterisk
.	Point
x	Cross
s	Square
d	Diamond
^	Upward-pointing triangle
v	Downward-pointing triangle
>	Right-pointing triangle
<	Left-pointing triangle
p	Pentagram
h	Hexagram

Color Specifier	Description
y	yellow
m	magenta
c	cyan
r	red
g	green
b	blue

Color Specifier	Description
w	white
k	black

Name-Value Pair Arguments

Specify optional comma-separated pairs of `Name`, `Value` arguments. `Name` is the argument name and `Value` is the corresponding value. `Name` must appear inside quotes. You can specify several name and value pair arguments in any order as `Name1, Value1, ..., NameN, ValueN`.

Example: `'Marker', 'o', 'MarkerFaceColor', 'red'`

The properties listed here are only a subset. For a complete list, see [Parameterized Function Line](#).

MeshDensity — Number of evaluation points

23 (default) | number

Number of evaluation points, specified as a number. The default is 23. Because `fplot3` uses adaptive evaluation, the actual number of evaluation points is greater.

Color — Line color







[0 0.4470 0.7410] (default) | RGB triplet | hexadecimal color code | 'r' | 'g' | 'b' | ...

Line color, specified as an RGB triplet, a hexadecimal color code, a color name, or a short name.





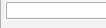

For a custom color, specify an RGB triplet or a hexadecimal color code.

- An RGB triplet is a three-element row vector whose elements specify the intensities of the red, green, and blue components of the color. The intensities must be in the range `[0, 1]`; for example, `[0.4 0.6 0.7]`.
- A hexadecimal color code is a character vector or a string scalar that starts with a hash symbol (`#`) followed by three or six hexadecimal digits, which can range from `0` to `F`. The values are not case sensitive. Thus, the color codes `'#FF8800'`, `'#ff8800'`, `'#F80'`, and `'#f80'` are equivalent.

Alternatively, you can specify some common colors by name. This table lists the named color options, the equivalent RGB triplets, and hexadecimal color codes.

Color Name	Short Name	RGB Triplet	Hexadecimal Color Code	Appearance
'red'	'r'	[1 0 0]	'#FF0000'	
'green'	'g'	[0 1 0]	'#00FF00'	
'blue'	'b'	[0 0 1]	'#0000FF'	
'cyan'	'c'	[0 1 1]	'#00FFFF'	
'magenta'	'm'	[1 0 1]	'#FF00FF'	
'yellow'	'y'	[1 1 0]	'#FFFF00'	
'black'	'k'	[0 0 0]	'#000000'	
'white'	'w'	[1 1 1]	'#FFFFFF'	

Here are the RGB triplets and hexadecimal color codes for the default colors MATLAB uses in many types of plots.

RGB Triplet	Hexadecimal Color Code	Appearance
[0 0.4470 0.7410]	'#0072BD'	
[0.8500 0.3250 0.0980]	'#D95319'	
[0.9290 0.6940 0.1250]	'#EDB120'	
[0.4940 0.1840 0.5560]	'#7E2F8E'	
[0.4660 0.6740 0.1880]	'#77AC30'	
[0.3010 0.7450 0.9330]	'#4DBEEE'	
[0.6350 0.0780 0.1840]	'#A2142F'	

Example: 'blue'





Example: [0 0 1]

Example: '#0000FF'

LineStyle – Line style

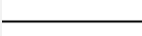
'-' (default) | '--' | ':' | '- .' | 'none'

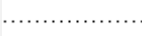
Line style, specified as one of the options listed in this table.

Line Style	Description	Resulting Line
'-'	Solid line	
'--'	Dashed line	
':'	Dotted line	
'- .'	Dash-dotted line	
'none'	No line	No line

LineWidth – Line width

0.5 (default) | positive value

Line width, specified as a positive value in points, where 1 point = 1/72 of an inch. If the line has markers, then the line width also affects the marker edges.

The line width cannot be thinner than the width of a pixel. If you set the line width to a value that is less than the width of a pixel on your system, the line displays as one pixel wide.

Marker – Marker symbol

'none' (default) | 'o' | '+' | '*' | '.' | 'x' | 's' | 'd' | ...

Marker symbol, specified as one of the values in this table. By default, a line does not have markers. Add markers at selected points along the line by specifying a marker.

Value	Description
'o'	Circle
'+'	Plus sign

Value	Description
'*'	Asterisk
'.'	Point
'x'	Cross
'square' or 's'	Square
'diamond' or 'd'	Diamond
'^'	Upward-pointing triangle
'v'	Downward-pointing triangle
'>'	Right-pointing triangle
'<'	Left-pointing triangle
'pentagram' or 'p'	Five-pointed star (pentagram)
'hexagram' or 'h'	Six-pointed star (hexagram)
'none'	No markers

MarkerEdgeColor — Marker outline color







'auto' (default) | RGB triplet | hexadecimal color code | 'r' | 'g' | 'b' | ...

Marker outline color, specified as 'auto', an RGB triplet, a hexadecimal color code, a color name, or a short name. The default value of 'auto' uses the same color as the Color property.

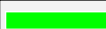

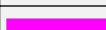



For a custom color, specify an RGB triplet or a hexadecimal color code.

- An RGB triplet is a three-element row vector whose elements specify the intensities of the red, green, and blue components of the color. The intensities must be in the range $[0, 1]$; for example, $[0.4 \ 0.6 \ 0.7]$.
- A hexadecimal color code is a character vector or a string scalar that starts with a hash symbol (#) followed by three or six hexadecimal digits, which can range from 0 to F. The values are not case sensitive. Thus, the color codes '#FF8800', '#ff8800', '#F80', and '#f80' are equivalent.

Alternatively, you can specify some common colors by name. This table lists the named color options, the equivalent RGB triplets, and hexadecimal color codes.

Color Name	Short Name	RGB Triplet	Hexadecimal Color Code	Appearance
'red'	'r'	[1 0 0]	'#FF0000'	
'green'	'g'	[0 1 0]	'#00FF00'	
'blue'	'b'	[0 0 1]	'#0000FF'	
'cyan'	'c'	[0 1 1]	'#00FFFF'	
'magenta'	'm'	[1 0 1]	'#FF00FF'	
'yellow'	'y'	[1 1 0]	'#FFFF00'	
'black'	'k'	[0 0 0]	'#000000'	
'white'	'w'	[1 1 1]	'#FFFFFF'	
'none'	Not applicable	Not applicable	Not applicable	No color

Here are the RGB triplets and hexadecimal color codes for the default colors MATLAB uses in many types of plots.

RGB Triplet	Hexadecimal Color Code	Appearance
[0 0.4470 0.7410]	'#0072BD'	
[0.8500 0.3250 0.0980]	'#D95319'	
[0.9290 0.6940 0.1250]	'#EDB120'	
[0.4940 0.1840 0.5560]	'#7E2F8E'	
[0.4660 0.6740 0.1880]	'#77AC30'	
[0.3010 0.7450 0.9330]	'#4DBEEE'	
[0.6350 0.0780 0.1840]	'#A2142F'	

MarkerFaceColor — Marker fill color







'none' (default) | 'auto' | RGB triplet | hexadecimal color code | 'r' | 'g' | 'b' | ...

Marker fill color, specified as 'auto', an RGB triplet, a hexadecimal color code, a color name, or a short name. The 'auto' value uses the same color as the MarkerEdgeColor property.





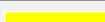

For a custom color, specify an RGB triplet or a hexadecimal color code.

- An RGB triplet is a three-element row vector whose elements specify the intensities of the red, green, and blue components of the color. The intensities must be in the range [0, 1]; for example, [0.4 0.6 0.7].
- A hexadecimal color code is a character vector or a string scalar that starts with a hash symbol (#) followed by three or six hexadecimal digits, which can range from 0 to F. The values are not case sensitive. Thus, the color codes '#FF8800', '#ff8800', '#F80', and '#f80' are equivalent.

Alternatively, you can specify some common colors by name. This table lists the named color options, the equivalent RGB triplets, and hexadecimal color codes.

Color Name	Short Name	RGB Triplet	Hexadecimal Color Code	Appearance
'red'	'r'	[1 0 0]	'#FF0000'	
'green'	'g'	[0 1 0]	'#00FF00'	
'blue'	'b'	[0 0 1]	'#0000FF'	
'cyan'	'c'	[0 1 1]	'#00FFFF'	
'magenta'	'm'	[1 0 1]	'#FF00FF'	
'yellow'	'y'	[1 1 0]	'#FFFF00'	
'black'	'k'	[0 0 0]	'#000000'	
'white'	'w'	[1 1 1]	'#FFFFFF'	
'none'	Not applicable	Not applicable	Not applicable	No color

Here are the RGB triplets and hexadecimal color codes for the default colors MATLAB uses in many types of plots.

RGB Triplet	Hexadecimal Color Code	Appearance
[0 0.4470 0.7410]	'#0072BD'	
[0.8500 0.3250 0.0980]	'#D95319'	
[0.9290 0.6940 0.1250]	'#EDB120'	
[0.4940 0.1840 0.5560]	'#7E2F8E'	
[0.4660 0.6740 0.1880]	'#77AC30'	
[0.3010 0.7450 0.9330]	'#4DBEEE'	
[0.6350 0.0780 0.1840]	'#A2142F'	

Example: [0.3 0.2 0.1]

Example: 'green'

Example: '#D2F9A7'

MarkerSize – Marker size

6 (default) | positive value

Marker size, specified as a positive value in points, where 1 point = 1/72 of an inch.

Output Arguments

fp – One or more parameterized function line objects

scalar | vector

One or more parameterized line objects, returned as a scalar or a vector. You can use these objects to query and modify properties of a specific parameterized line. For details, see Parameterized Function Line.

See Also

Functions

fcontour | fimplicit | fimplicit3 | fmesh | fplot | fsurf

Properties

Parameterized Function Line

Topics

“Create Plots” on page 2-229

Introduced in R2016a

fresnelc

Fresnel cosine integral function

Syntax

`fresnelc(z)`

Description

`fresnelc(z)` returns the Fresnel cosine integral on page 4-603 of *z*.

Examples

Fresnel Cosine Integral Function for Numeric and Symbolic Input Arguments

Find the Fresnel cosine integral function for these numbers. Since these are not symbolic objects, you receive floating-point results.

```
fresnelc([-2 0.001 1.22+0.31i])

ans =
-0.4883 + 0.0000i    0.0010 + 0.0000i    0.8617 - 0.2524i
```

Find the Fresnel cosine integral function symbolically by converting the numbers to symbolic objects:

```
y = fresnelc(sym([-2 0.001 1.22+0.31i]))

y =
[ -fresnelc(2), fresnelc(1/1000), fresnelc(61/50 + 31i/100)]
```

Use `vpa` to approximate results:

```
vpa(y)

ans =
[ -0.48825340607534075450022350335726, 0.00099999999999975325988997279422003, ...
 0.86166573430841730950055370401908 - 0.25236540291386150167658349493972i]
```

Fresnel Cosine Integral Function for Special Values

Find the Fresnel cosine integral function for special values:

```
fresnelc([0 Inf -Inf i*Inf -i*Inf])

ans =
0.0000 + 0.0000i    0.5000 + 0.0000i    -0.5000 + 0.0000i...
 0.0000 + 0.5000i    0.0000 - 0.5000i
```

Fresnel Cosine Integral for Symbolic Functions

Find the Fresnel cosine integral for the function $\exp(x) + 2*x$:

```
syms f(x)
f = exp(x)+2*x;
fresnelc(f)

ans =
fresnelc(2*x + exp(x))
```

Fresnel Cosine Integral for Symbolic Vectors and Arrays

Find the Fresnel cosine integral for elements of vector V and matrix M:

```
syms x
V = [sin(x) 2i -7];
M = [0 2; i exp(x)];
fresnelc(V)
fresnelc(M)

ans =
[ fresnelc(sin(x)), fresnelc(2i), -fresnelc(7)]
ans =
[          0,          fresnelc(2)]
[ fresnelc(1i), fresnelc(exp(x))]
```

Plot Fresnel Cosine Integral Function

Plot the Fresnel cosine integral function from $x = -5$ to $x = 5$.

```
syms x
fplot(fresnelc(x),[-5 5])
grid on
```

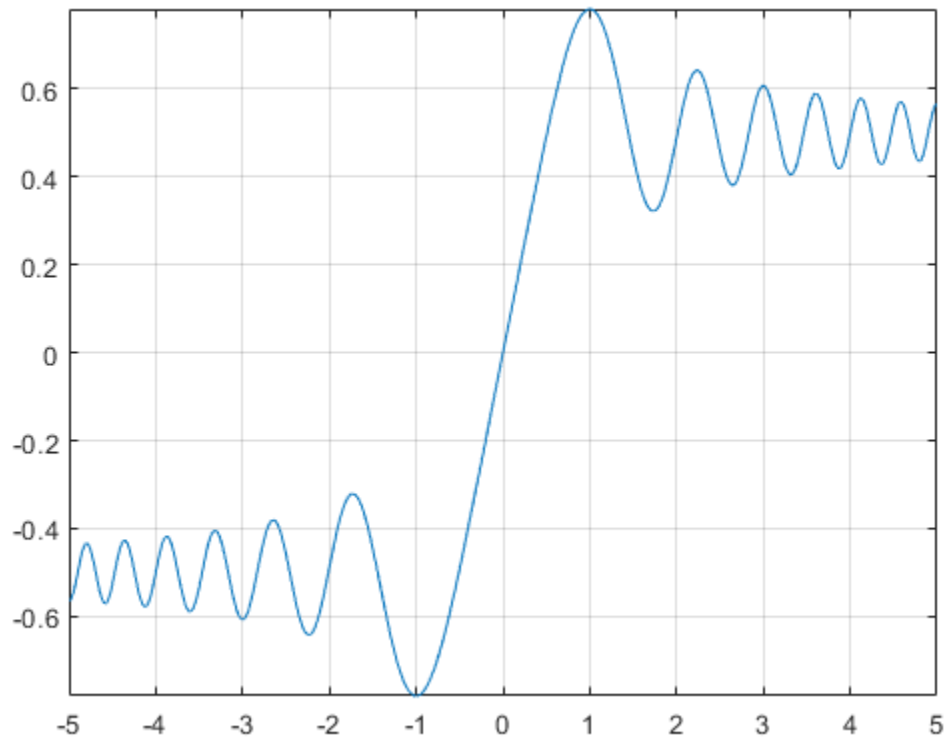

Differentiate and Find Limits of Fresnel Cosine Integral

The functions `diff` and `limit` handle expressions containing `fresnelc`.

Find the third derivative of the Fresnel cosine integral function:

```
syms x
diff(fresnelc(x),x,3)

ans =
- pi*sin((pi*x^2)/2) - x^2*pi^2*cos((pi*x^2)/2)
```

Find the limit of the Fresnel cosine integral function as x tends to infinity:

```
syms x
limit(fresnelc(x),Inf)

ans =
1/2
```

Taylor Series Expansion of Fresnel Cosine Integral

Use `taylor` to expand the Fresnel cosine integral in terms of the Taylor series:

```
syms x
taylor(fresnelc(x))
```



```
ans =
x - (x^5*pi^2)/40
```

Simplify Expressions Containing fresnelc

Use `simplify` to simplify expressions:

```
syms x
simplify(3*fresnelc(x)+2*fresnelc(-x))

ans =
fresnelc(x)
```

Input Arguments

z — Upper limit on Fresnel cosine integral

numeric value | vector | matrix | multidimensional array | symbolic variable | symbolic expression | symbolic vector | symbolic matrix | symbolic function

Upper limit on the Fresnel cosine integral, specified as a numeric value, vector, matrix, or as a multidimensional array, or a symbolic variable, expression, vector, matrix, or function.

More About

Fresnel Cosine Integral

The Fresnel cosine integral of z is

$$\text{fresnelc}(z) = \int_0^z \cos\left(\frac{\pi t^2}{2}\right) dt.$$

Algorithms

`fresnelc` is analytic throughout the complex plane. It satisfies $\text{fresnelc}(-z) = -\text{fresnelc}(z)$, $\text{conj}(\text{fresnelc}(z)) = \text{fresnelc}(\text{conj}(z))$, and $\text{fresnelc}(i*z) = i*\text{fresnelc}(z)$ for all complex values of z .

`fresnelc` returns special values for $z = 0$, $z = \pm\infty$, and $z = \pm i\infty$ which are 0, ± 5 , and $\pm 0.5i$. `fresnelc(z)` returns symbolic function calls for all other symbolic values of z .

See Also

`erf` | `fresnels`

Introduced in R2014a

fresnels

Fresnel sine integral function

Syntax

```
fresnels(z)
```

Description

`fresnels(z)` returns the Fresnel sine integral on page 4-606 of *z*.

Examples

Fresnel Sine Integral Function for Numeric and Symbolic Arguments

Find the Fresnel sine integral function for these numbers. Since these are not symbolic objects, you receive floating-point results.

```
fresnels([-2 0.001 1.22+0.31i])

ans =
-0.3434 + 0.0000i   0.0000 + 0.0000i   0.7697 + 0.2945i
```

Find the Fresnel sine integral function symbolically by converting the numbers to symbolic objects:

```
y = fresnels(sym([-2 0.001 1.22+0.31i]))

y =
[ -fresnels(2), fresnels(1/1000), fresnels(61/50 + 31i/100)]
```

Use `vpa` to approximate the results:

```
vpa(y)

ans =
[ -0.34341567836369824219530081595807, 0.00000000052359877559820659249174920261227, ...
 0.76969209233306959998384249252902 + 0.29449530344285433030167256417637i]
```

Fresnel Sine Integral for Special Values

Find the Fresnel sine integral function for special values:

```
fresnels([0 Inf -Inf i*Inf -i*Inf])

ans =
0.0000 + 0.0000i   0.5000 + 0.0000i  -0.5000 + 0.0000i   0.0000 - 0.5000i...
0.0000 + 0.5000i
```

Fresnel Sine Integral for Symbolic Functions

Find the Fresnel sine integral for the function $\exp(x) + 2*x$:

```
syms x
f = symfun(exp(x)+2*x,x);
fresnels(f)
```

```
ans(x) =
fresnels(2*x + exp(x))
```

Fresnel Sine Integral for Symbolic Vectors and Arrays

Find the Fresnel sine integral for elements of vector V and matrix M:

```
syms x
V = [sin(x) 2i -7];
M = [0 2; i exp(x)];
fresnels(V)
fresnels(M)

ans =
[ fresnels(sin(x)), fresnels(2i), -fresnels(7)]
ans =
[      0,      fresnels(2)]
[ fresnels(1i), fresnels(exp(x))]
```

Plot Fresnel Sine Integral Function

Plot the Fresnel sine integral function from $x = -5$ to $x = 5$.

```
syms x
fplot(fresnels(x),[-5 5])
grid on
```

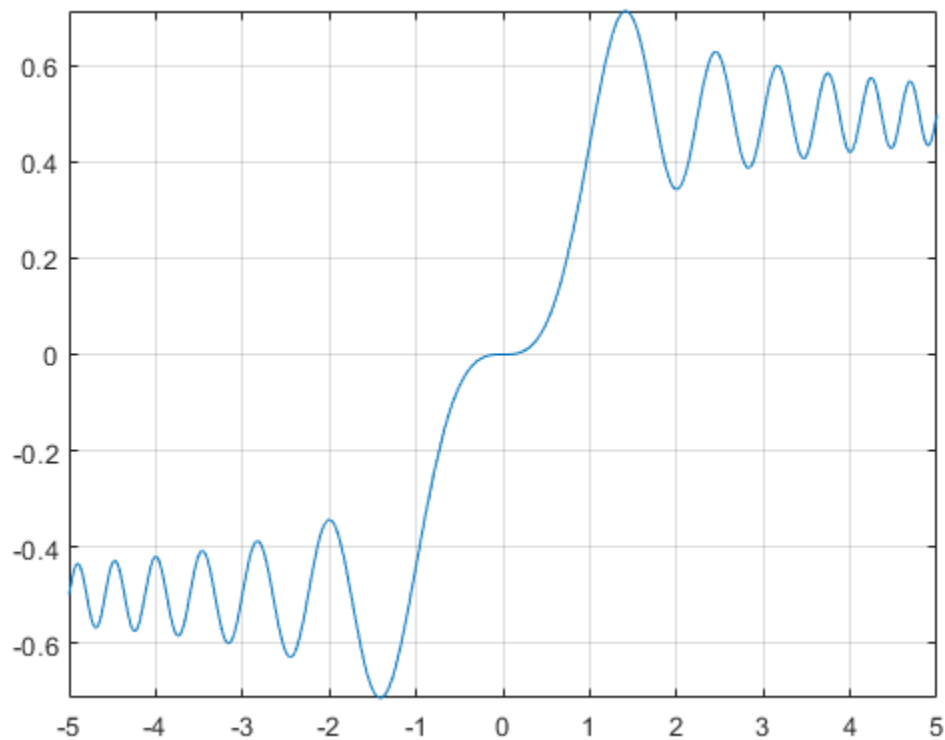

Differentiate and Find Limits of Fresnel Sine Integral

The functions `diff` and `limit` handle expressions containing `fresnels`.

Find the fourth derivative of the Fresnel sine integral function:

```
syms x
diff(fresnels(x),x,4)

ans =
- 3*x*pi^2*sin((pi*x^2)/2) - x^3*pi^3*cos((pi*x^2)/2)
```

Find the limit of the Fresnel sine integral function as x tends to infinity:

```
syms x
limit(fresnels(x),Inf)

ans =
1/2
```

Taylor Series Expansion of Fresnel Sine Integral

Use `taylor` to expand the Fresnel sine integral in terms of the Taylor series:

```
syms x
taylor(fresnels(x))

ans =
(pi*x^3)/6
```

Simplify Expressions Containing fresnels

Use `simplify` to simplify expressions:

```
syms x
simplify(3*fresnels(x)+2*fresnels(-x))

ans =
fresnels(x)
```

Input Arguments

z — Upper limit on the Fresnel sine integral

numeric value | vector | matrix | multidimensional array | symbolic variable | symbolic expression | symbolic vector | symbolic matrix | symbolic function

Upper limit on the Fresnel sine integral, specified as a numeric value, vector, matrix, or a multidimensional array or as a symbolic variable, expression, vector, matrix, or function.

More About

Fresnel Sine Integral

The Fresnel sine integral of z is

$$\text{fresnels}(z) = \int_0^z \sin\left(\frac{\pi t^2}{2}\right) dt$$

Algorithms

The `fresnels(z)` function is analytic throughout the complex plane. It satisfies $\text{fresnels}(-z) = -\text{fresnels}(z)$, $\text{conj}(\text{fresnels}(z)) = \text{fresnels}(\text{conj}(z))$, and $\text{fresnels}(i*z) = -i*\text{fresnels}(z)$ for all complex values of z .

`fresnels(z)` returns special values for $z = 0$, $z = \pm\infty$, and $z = \pm i\infty$ which are 0 , ± 5 , and $\mp 0.5i$.
`fresnels(z)` returns symbolic function calls for all other symbolic values of z .

See Also

`erf` | `fresnelc`

Introduced in R2014a

fsurf

Plot 3-D surface

Syntax

```
fsurf(f)
fsurf(f,[min max])
fsurf(f,[xmin xmax ymin ymax])

fsurf(funx,funy,funz)
fsurf(funx,funy,funz,[uvmin uvmax])
fsurf(funx,funy,funz,[umin umax vmin vmax])

fsurf( ____,LineStyle)
fsurf( ____,Name,Value)
fsurf(ax, ____)
fs = fsurf( ____)
```

Description

`fsurf(f)` creates a surface plot of the symbolic expression $f(x,y)$ over the default interval $[-5\ 5]$ for x and y .

`fsurf(f,[min max])` plots $f(x,y)$ over the interval $[min\ max]$ for x and y .

`fsurf(f,[xmin xmax ymin ymax])` plots $f(x,y)$ over the interval $[xmin\ xmax]$ for x and $[ymin\ ymax]$ for y . The `fsurf` function uses `symvar` to order the variables and assign intervals.

`fsurf(funx,funy,funz)` plots the parametric surface $x = x(u,v)$, $y = y(u,v)$, $z = z(u,v)$ over the interval $[-5\ 5]$ for u and v .

`fsurf(funx,funy,funz,[uvmin uvmax])` plots the parametric surface $x = x(u,v)$, $y = y(u,v)$, $z = z(u,v)$ over the interval $[uvmin\ uvmax]$ for u and v .

`fsurf(funx,funy,funz,[umin umax vmin vmax])` plots the parametric surface $x = x(u,v)$, $y = y(u,v)$, $z = z(u,v)$ over the interval $[umin\ umax]$ for u and $[vmin\ vmax]$ for v . The `fsurf` function uses `symvar` to order the parametric variables and assign intervals.

`fsurf(____,LineStyle)` uses `LineStyle` to set the line style, marker symbol, and face color. Use this option after any of the previous input argument combinations.

`fsurf(____,Name,Value)` specifies line properties using one or more `Name,Value` pair arguments. Use this option after any of the input argument combinations in the previous syntaxes.

`fsurf(ax, ____)` plots into the axes with the object `ax` instead of the current axes object `gca`.

`fs = fsurf(____)` returns a function surface object or parameterized function surface object, depending on the type of surface. Use the object to query and modify properties of a specific surface. For details, see [Function Surface](#) and [Parameterized Function Surface](#).

Examples

3-D Surface Plot of Symbolic Expression

Plot the input $\sin(x) + \cos(y)$ over the default range $-5 < x < 5$ and $-5 < y < 5$.

```
syms x y
fsurf(sin(x)+cos(y))
```

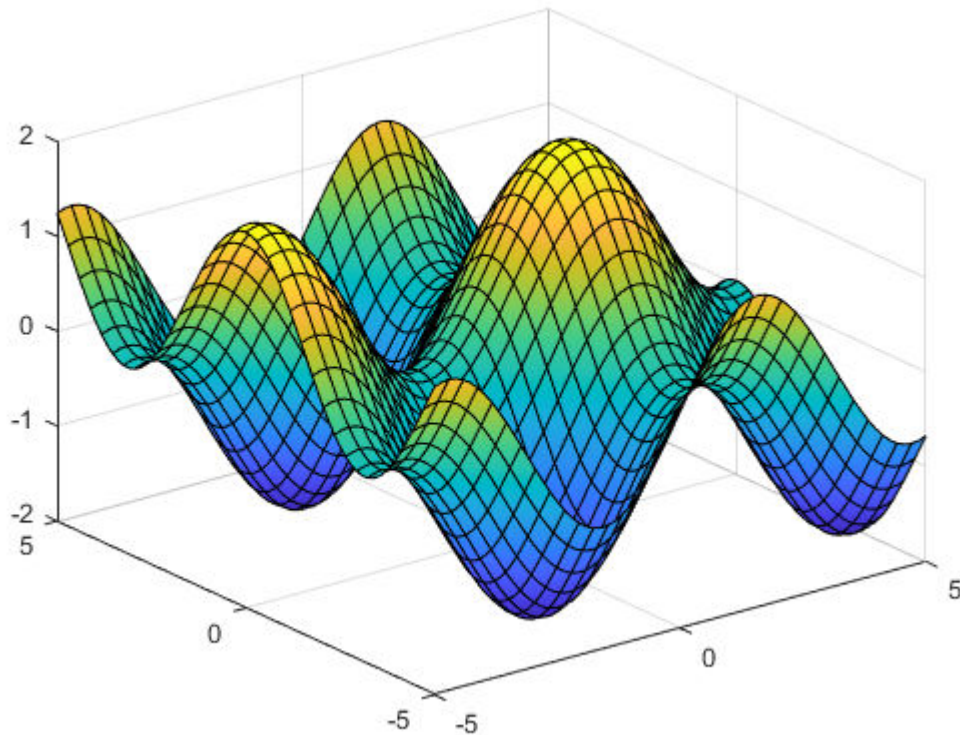

3-D Surface Plot of Symbolic Function

Plot the real part of $\tan^{-1}(x + iy)$ over the default range $-5 < x < 5$ and $-5 < y < 5$.

```
syms f(x,y)
f(x,y) = real(atan(x + i*y));
fsurf(f)
```

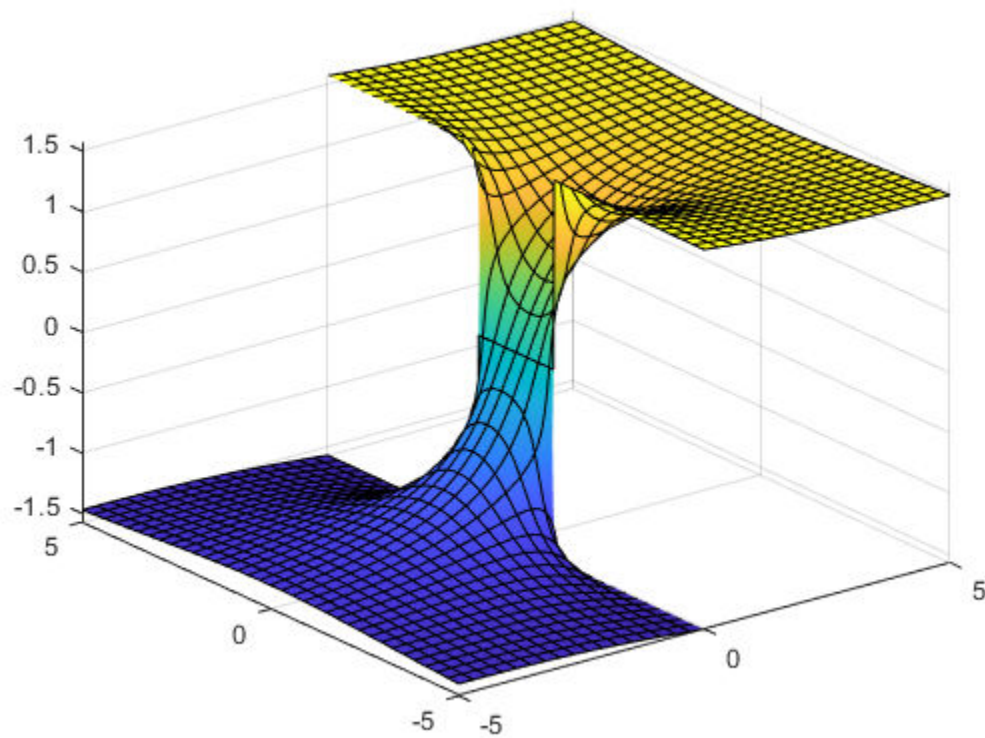

Specify Plotting Interval of Surface Plot

Plot $\sin(x) + \cos(y)$ over $-\pi < x < \pi$ and $-5 < y < 5$ by specifying the plotting interval as the second argument of `fsurf`.

```
syms x y
f = sin(x) + cos(y);
fsurf(f, [-pi pi -5 5])
```

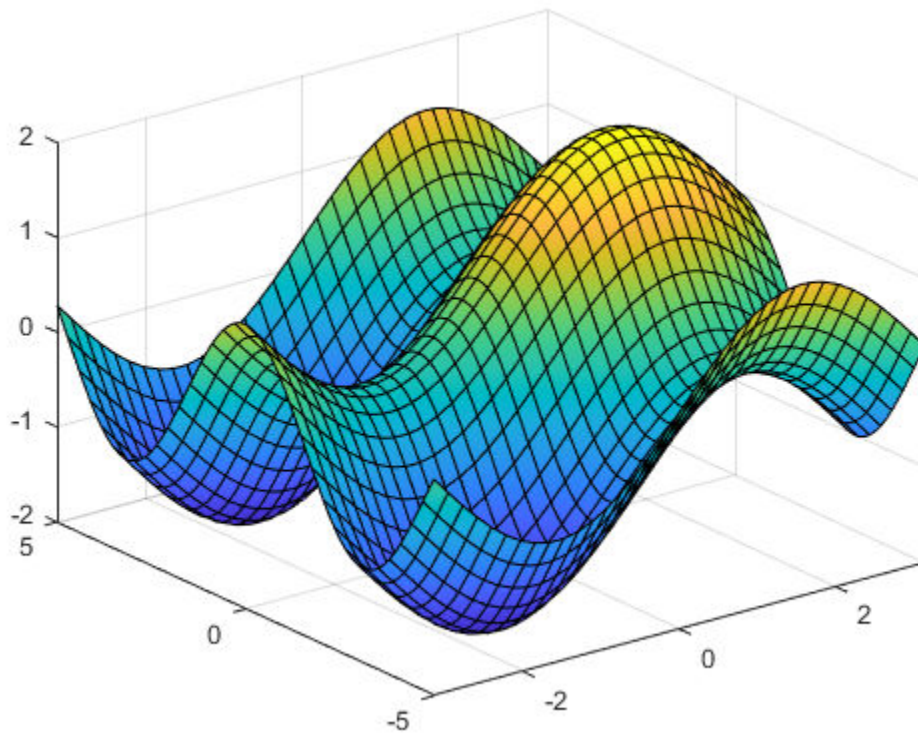
Parameterized Surface Plot

Plot the parameterized surface

$$x = r\cos(s)\sin(t)$$

$$y = r\sin(s)\sin(t)$$

$$z = r\cos(t)$$

$$\text{where } r = 2 + \sin(7s + 5t)$$

for $0 < s < 2\pi$ and $0 < t < \pi$.

Improve the plot's appearance by using `camlight`.

```
syms s t
r = 2 + sin(7*s + 5*t);
x = r*cos(s)*sin(t);
y = r*sin(s)*sin(t);
z = r*cos(t);
fsurf(x, y, z, [0 2*pi 0 pi])
camlight
view(46,52)
```

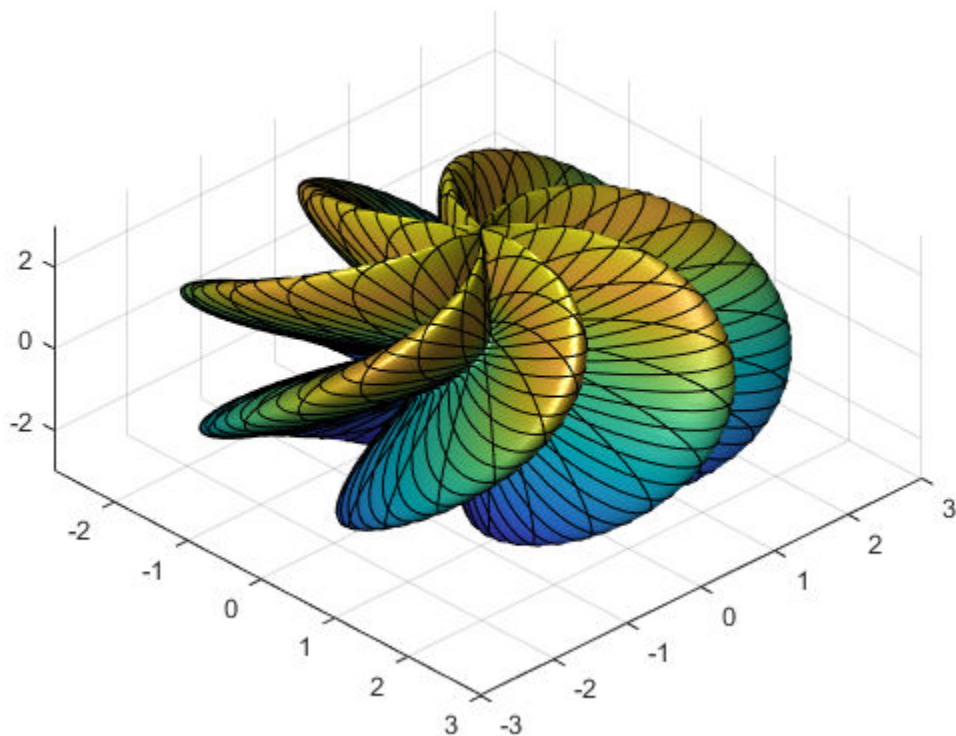

Surface Plot of Piecewise Expression

Plot the piecewise expression of the Klein bottle

$$x(u, v) = \begin{cases} -4 \cos(u) [1 + \sin(u)] - r(u) \cos(u) \cos(v) & 0 < u \leq \pi \\ -4 \cos(u) [1 + \sin(u)] + r(u) \cos(v) & \pi < u < 2\pi \end{cases}$$

$$y(u, v) = r(u) \sin(v)$$

$$z(u, v) = \begin{cases} -14 \sin(u) - r(u) \sin(u) \cos(v) & 0 < u \leq \pi \\ -14 \sin(u) & \pi < u < 2\pi \end{cases}$$

$$\text{where } r(u) = 4 - 2 \cos(u)$$

for $0 < u < 2\pi$ and $0 < v < 2\pi$.

Show that the Klein bottle has only a one-sided surface.

```
syms u v;
r = @(u) 4 - 2*cos(u);
x = piecewise(u <= pi, -4*cos(u)*(1+sin(u)) - r(u)*cos(u)*cos(v), ...
             u > pi, -4*cos(u)*(1+sin(u)) + r(u)*cos(v));
y = r(u)*sin(v);
z = piecewise(u <= pi, -14*sin(u) - r(u)*sin(u)*cos(v), ...
             u > pi, -14*sin(u));
h = fsurf(x,y,z, [0 2*pi 0 2*pi]);
```

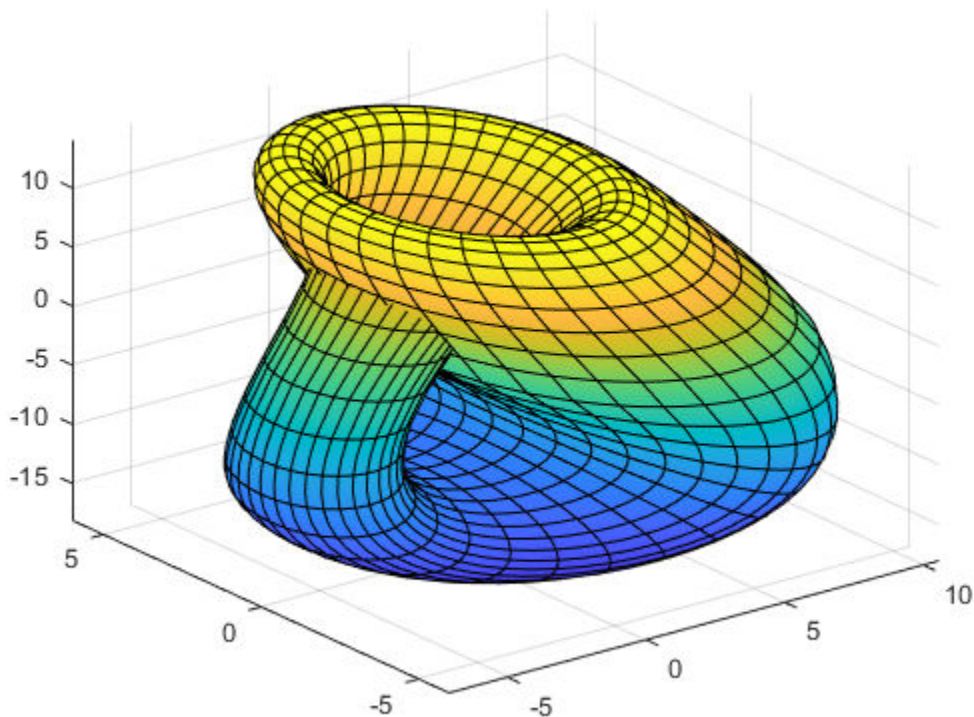

Add Title and Axis Labels and Format Ticks

For x and y from -2π to 2π , plot the 3-D surface $y\sin(x) - x\cos(y)$. Add a title and axis labels.

Create the x-axis ticks by spanning the x-axis limits at intervals of $\pi/2$. Convert the axis limits to precise multiples of $\pi/2$ by using `round` and get the symbolic tick values in `S`. Display these ticks by using the `XTick` property. Create x-axis labels by using `arrayfun` to apply `texlabel` to `S`. Display these labels by using the `XTickLabel` property. Repeat these steps for the y-axis.

To use LaTeX in plots, see `latex`.

```
syms x y
fsurf(y.*sin(x)-x.*cos(y), [-2*pi 2*pi])
title('y sin(x) - x cos(y) for x and y in [-2\pi,2\pi]')
xlabel('x')
ylabel('y')
zlabel('z')

ax = gca;
S = sym(ax.XLim(1):pi/2:ax.XLim(2));
S = sym(round(vpa(S/pi*2))*pi/2);
ax.XTick = double(S);
ax.XTickLabel = arrayfun(@texlabel,S,'UniformOutput',false);

S = sym(ax.YLim(1):pi/2:ax.YLim(2));
S = sym(round(vpa(S/pi*2))*pi/2);
```

```
ax.YTick = double(S);
ax.YTickLabel = arrayfun(@texlabel,S,'UniformOutput',false);
```

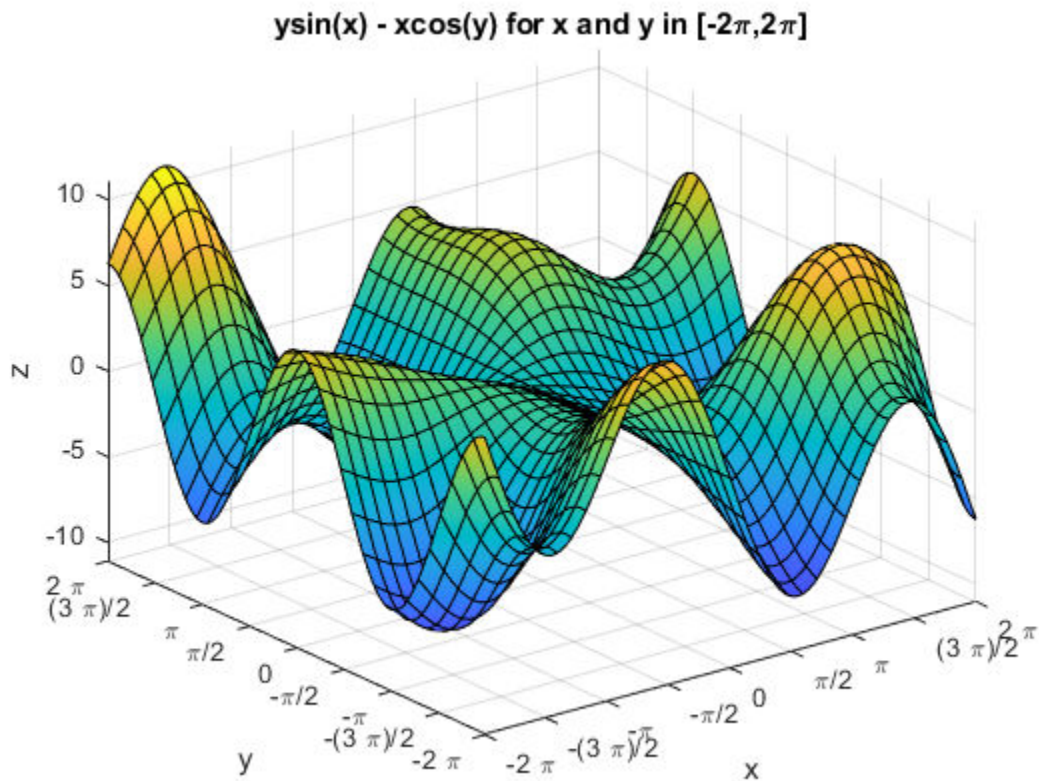

Line Style and Width for Surface Plot

Plot the parametric surface $x = s\sin(t)$, $y = -s\cos(t)$, $z = t$ with different line styles for different values of t . For $-5 < t < -2$, use a dashed line with green dot markers. For $-2 < t < 2$, use a LineWidth of 1 and a green face color. For $2 < t < 5$, turn off the lines by setting EdgeColor to none.

```
syms s t
fsurf(s*sin(t),-s*cos(t),t,[-5 5 -5 -2], '--.', 'MarkerEdgeColor','g')
hold on
fsurf(s*sin(t),-s*cos(t),t,[-5 5 -2 2], 'LineWidth',1, 'FaceColor','g')
fsurf(s*sin(t),-s*cos(t),t,[-5 5 2 5], 'EdgeColor','none')
```

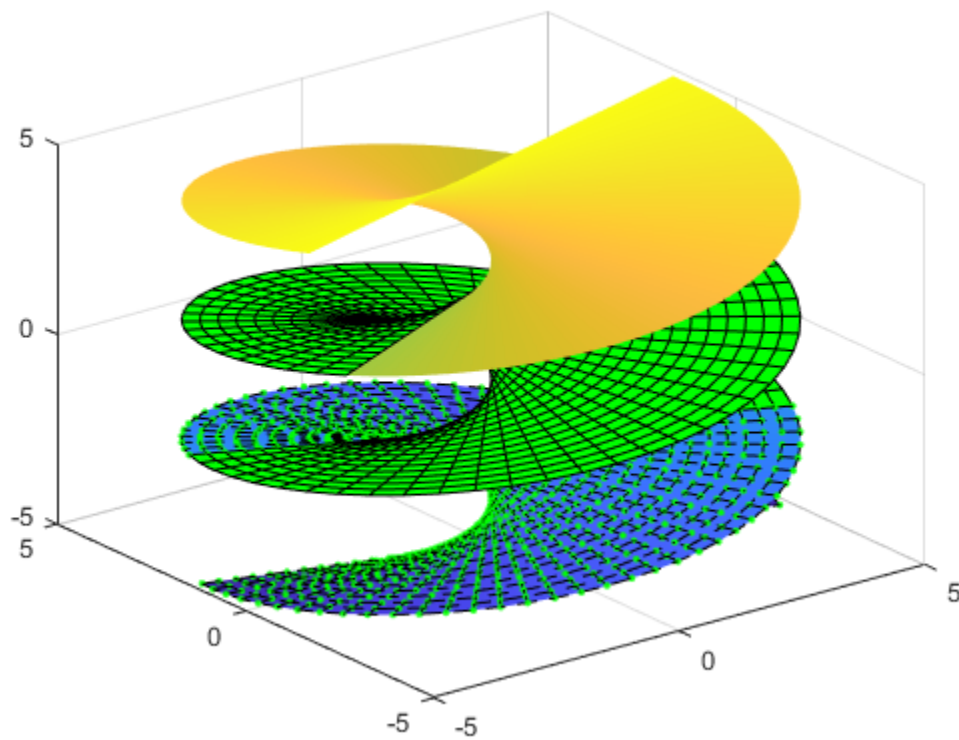

Modify Surface After Creation

Plot the parametric surface

$$x = e^{-|u|/10} \sin(5|v|)$$

$$y = e^{-|u|/10} \cos(5|v|)$$

$$z = u.$$

Specify an output to make `fcontour` return the plot object.

```
syms u v
x = exp(-abs(u)/10).*sin(5*abs(v));
y = exp(-abs(u)/10).*cos(5*abs(v));
z = u;
fs = fsurf(x,y,z)
```

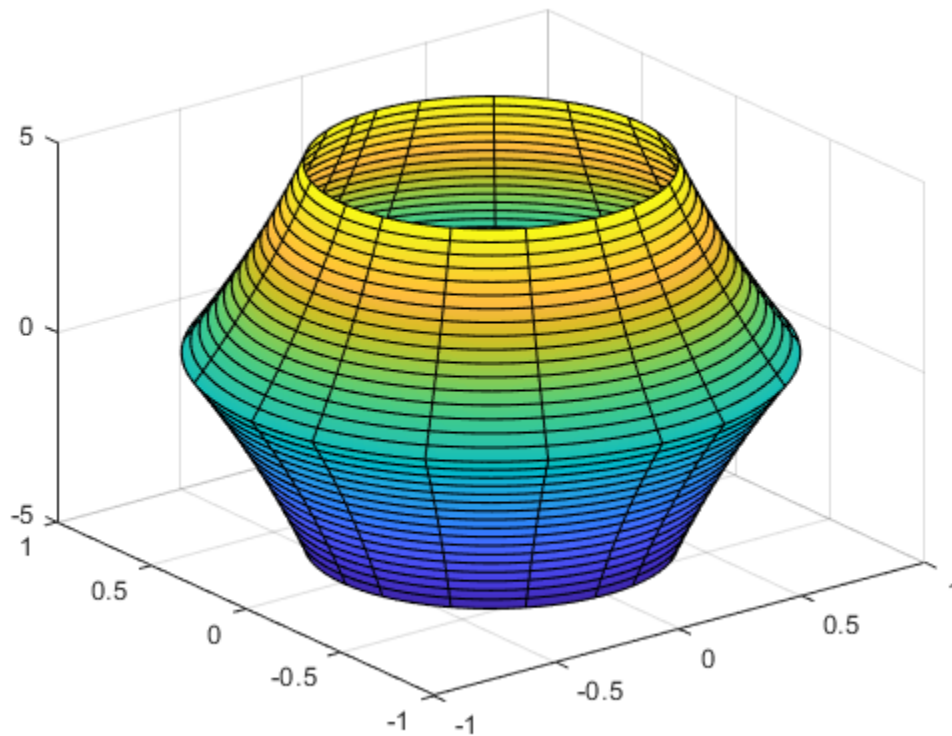

```
fs =  
  ParameterizedFunctionSurface with properties:  
  
  XFunction: [1x1 sym]  
  YFunction: [1x1 sym]  
  ZFunction: [1x1 sym]  
  EdgeColor: [0 0 0]  
  LineStyle: '-'  
  FaceColor: 'interp'
```

Show all properties

Change the range of u to $[-30\ 30]$ by using the `URange` property of `fs`. Set the line color to blue by using the `EdgeColor` property and specify white, dot markers by using the `Marker` and `MarkerEdgeColor` properties.

```
fs.URange = [-30 30];  
fs.EdgeColor = 'b';  
fs.Marker = '.';  
fs.MarkerEdgeColor = 'w';
```

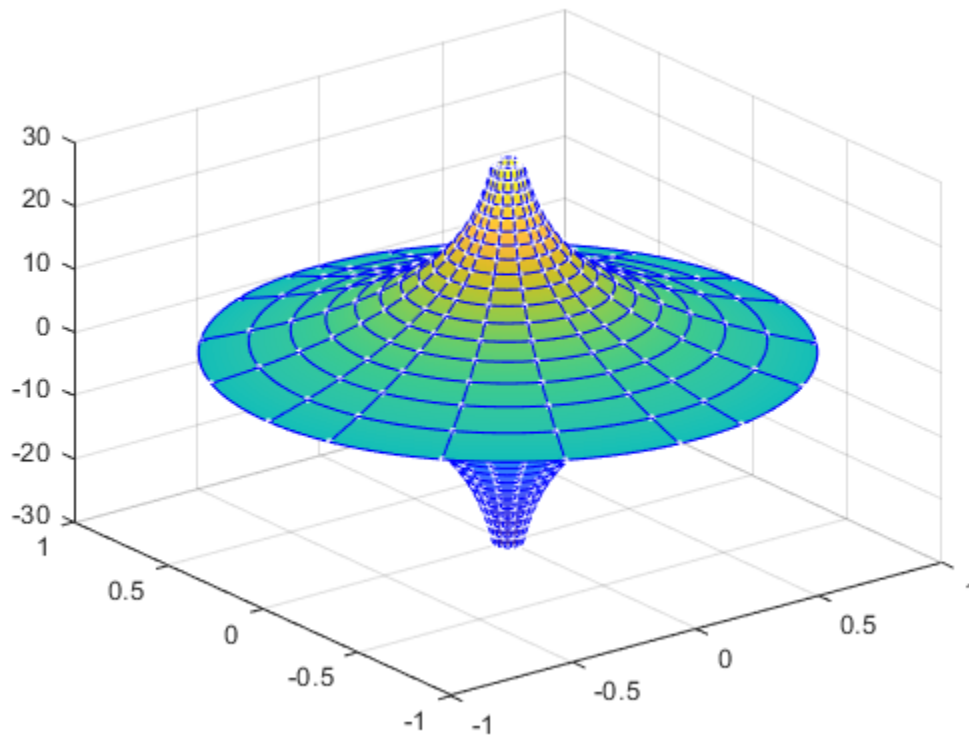

Multiple Surface Plots and Transparent Surfaces

Plot multiple surfaces using vector input to `fsurf`. Alternatively, use `hold` on to plot successively on the same figure. When displaying multiple surfaces on the same figure, transparency is useful. Adjust the transparency of surface plots by using the `FaceAlpha` property. `FaceAlpha` varies from 0 to 1, where 0 is full transparency and 1 is no transparency.

Plot the planes $x + y$ and $x - y$ using vector input to `fsurf`. Show both planes by making them half transparent using `FaceAlpha`.

```
syms x y
h = fsurf([x+y x-y]);
h(1).FaceAlpha = 0.5;
h(2).FaceAlpha = 0.5;
title('Planes (x+y) and (x-y) at half transparency')
```

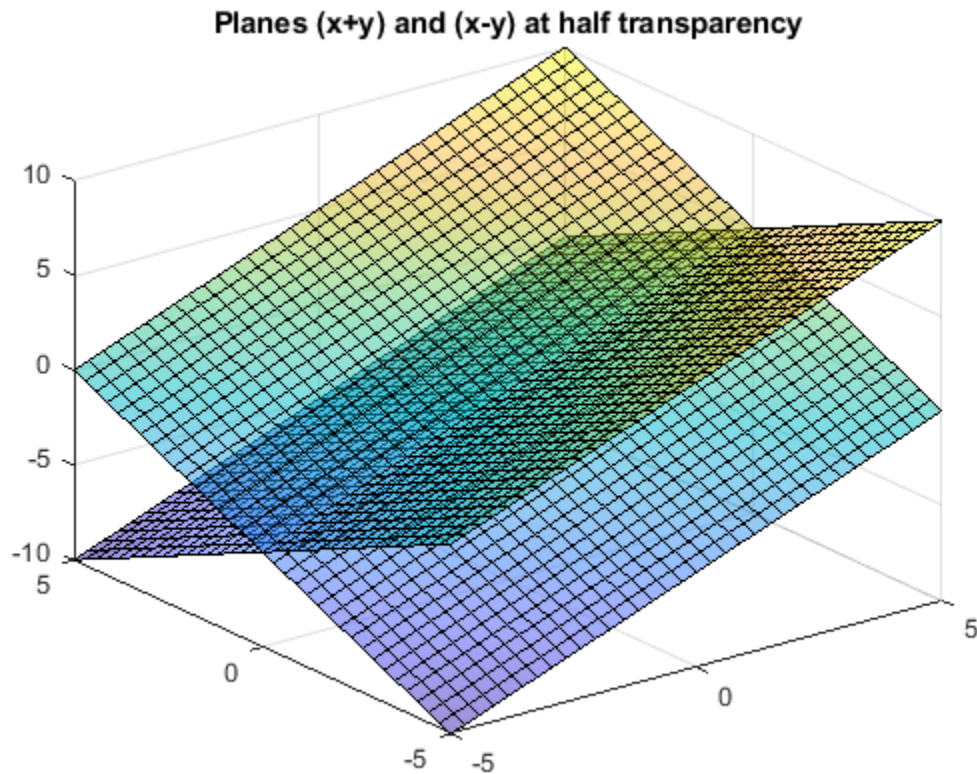

Control Resolution of Surface Plot

Control the resolution of a surface plot using the 'MeshDensity' option. Increasing 'MeshDensity' can make smoother, more accurate plots while decreasing it can increase plotting speed.

Divide a figure into two using `subplot`. In the first subplot, plot the parametric surface $x = \sin(s)$, $y = \cos(s)$, and $z = (t/10)\sin(1/s)$. The surface has a large gap. Fix this issue by increasing the 'MeshDensity' to 40 in the second subplot. `fsurf` fills the gap showing that by increasing 'MeshDensity' you increased the plot's resolution.

```
syms s t

subplot(2,1,1)
fsurf(sin(s), cos(s), t/10.*sin(1./s))
view(-172,25)
title('Default MeshDensity = 35')

subplot(2,1,2)
fsurf(sin(s), cos(s), t/10.*sin(1./s), 'MeshDensity', 40)
view(-172,25)
title('Increased MeshDensity = 40')
```

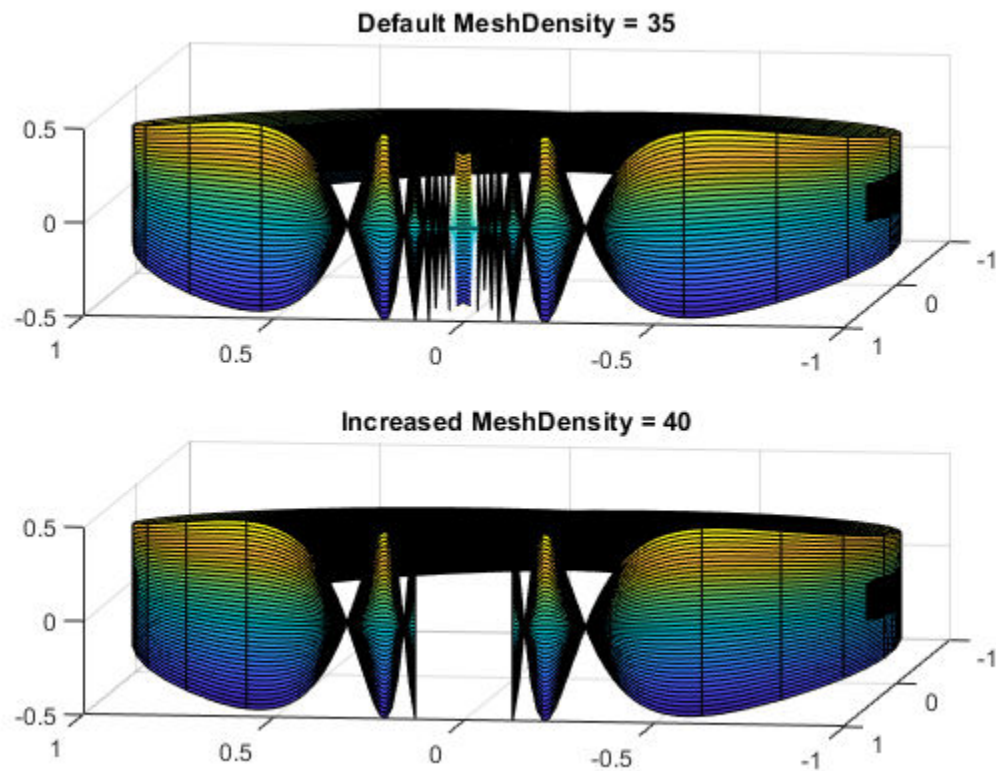
Show Contours Below Surface Plot

Show contours for the surface plot of the expression f by setting the 'ShowContours' option to 'on'.

```
syms x y
f = 3*(1-x)^2*exp(-(x^2) - (y+1)^2) ...
- 10*(x/5 - x^3 - y^5)*exp(-x^2-y^2) ...
- 1/3*exp(-(x+1)^2 - y^2);
fsurf(f, [-3 3], 'ShowContours', 'on')
```

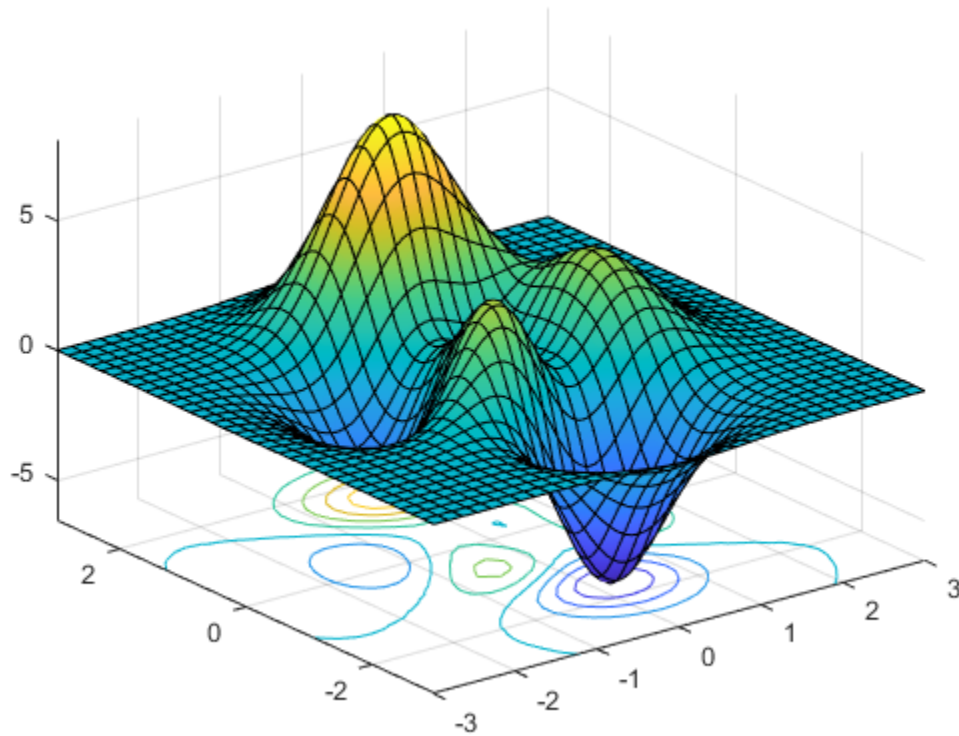

Create Animations of Surface Plots

Create animations by changing the displayed expression using the `Function`, `XFunction`, `YFunction`, and `ZFunction` properties and then by using `drawnow` to update the plot. To export to GIF, see `imwrite`.

By varying the variable i from 1 to 3, animate the parametric surface

$$\begin{aligned}x &= t \sin(s) \\y &= \cos(s) \\z &= \sin\left(\frac{i}{s}\right).\end{aligned}$$

for $-0.1 < u < 0.1$ and $0 < v < 1$. Increase plotting speed by reducing `MeshDensity` to 9.

```
syms s t
h = fsurf(t.*sin(s), cos(s), sin(1./s), [-0.1 0.1 0 1]);
h.MeshDensity = 9;
for i=1:0.05:3
    h.ZFunction = sin(i./s);
    drawnow
end
```

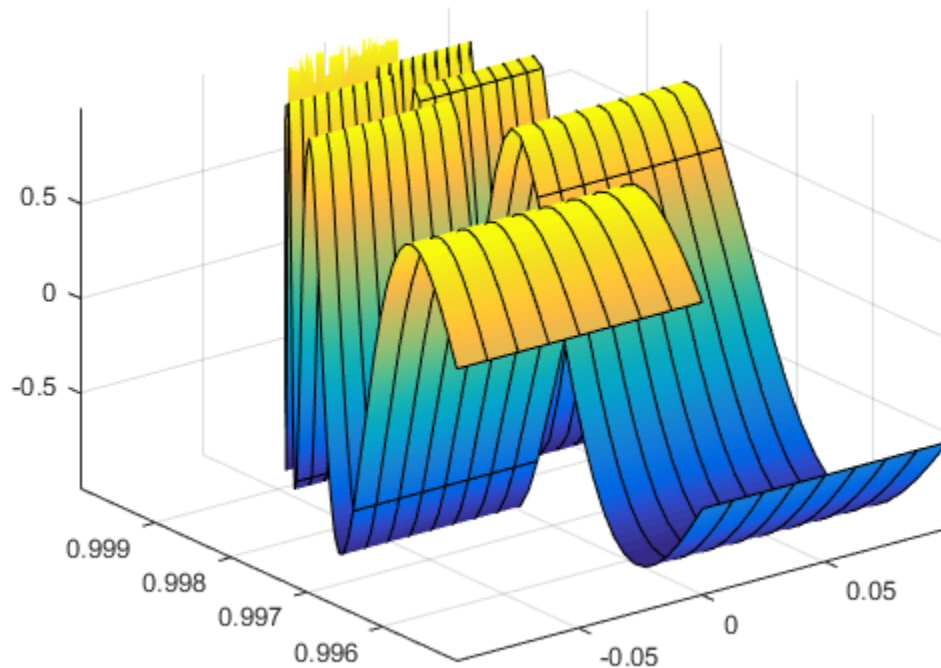

Improve Appearance of Surface Plot

Create a symbolic expression f for the function

$$f = 3(1 - x)^2 \exp(-x^2 - (y + 1)^2) - 10(x/5 - x^3 - y^5) \exp(-x^2 - y^2) - 1/3 \exp(-(x + 1)^2 - y^2).$$

Plot the expression f as a surface. Improve the appearance of the surface plot by using the properties of the handle returned by `fsurf`, the lighting properties, and the `colormap`.

Create a light by using `camlight`. Increase brightness by using `brighten`. Remove the lines by setting `EdgeColor` to `'none'`. Increase the ambient light using `AmbientStrength`. For details, see “Lighting, Transparency, and Shading” (MATLAB). Turn the axes box on. For the title, convert f to LaTeX using `latex`. Finally, to improve the appearance of the axes ticks, axes labels, and title, set `'Interpreter'` to `'latex'`.

```
syms x y
f = 3*(1-x)^2*exp(-(x^2)-(y+1)^2)...
    - 10*(x/5 - x^3 - y^5)*exp(-x^2-y^2)...
    - 1/3*exp(-(x+1)^2 - y^2);
h = fsurf(f,[-3 3]);

camlight(110,70)
brighten(0.6)
h.EdgeColor = 'none';
h.AmbientStrength = 0.4;

a = gca;
```

```

a.TickLabelInterpreter = 'latex';
a.Box = 'on';
a.BoxStyle = 'full';

xlabel('$x$', 'Interpreter', 'latex')
ylabel('$y$', 'Interpreter', 'latex')
zlabel('$z$', 'Interpreter', 'latex')
title_latex = ['$' latex(f) '$'];
title(title_latex, 'Interpreter', 'latex')

```

$$3e^{-(y+1)^2-x^2}(x-1)^2 - \frac{e^{-(x+1)^2-x^2}}{3} + e^{-x^2-y^2}(10x^3 - 2x + 10y^5)$$

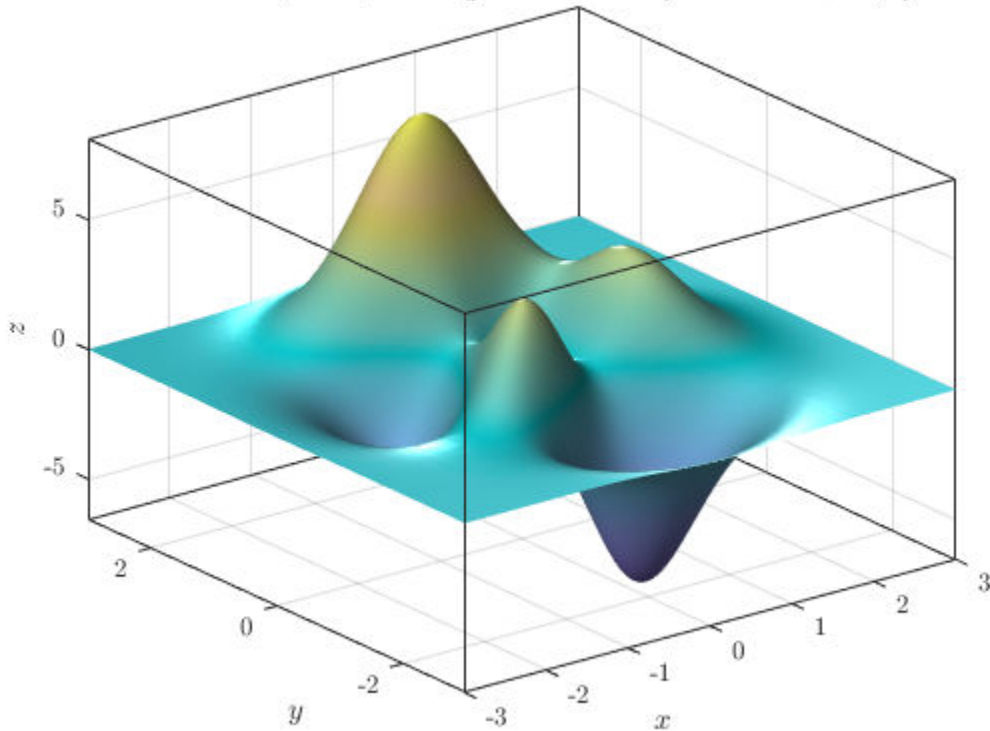

Surface Plot with Bounded Plane

Plot a cylindrical shell bounded below by the $x - y$ plane and above by the plane $z = x + 2$.

```

syms r t u
fsurf(cos(t), sin(t), u*(cos(t)+2), [0 2*pi 0 1])
hold on;

```

Add a surface plot of the plane $z = x + 2$.

```

fsurf(r*cos(t), r*sin(t), r*cos(t)+2, [0 1 0 2*pi])

```

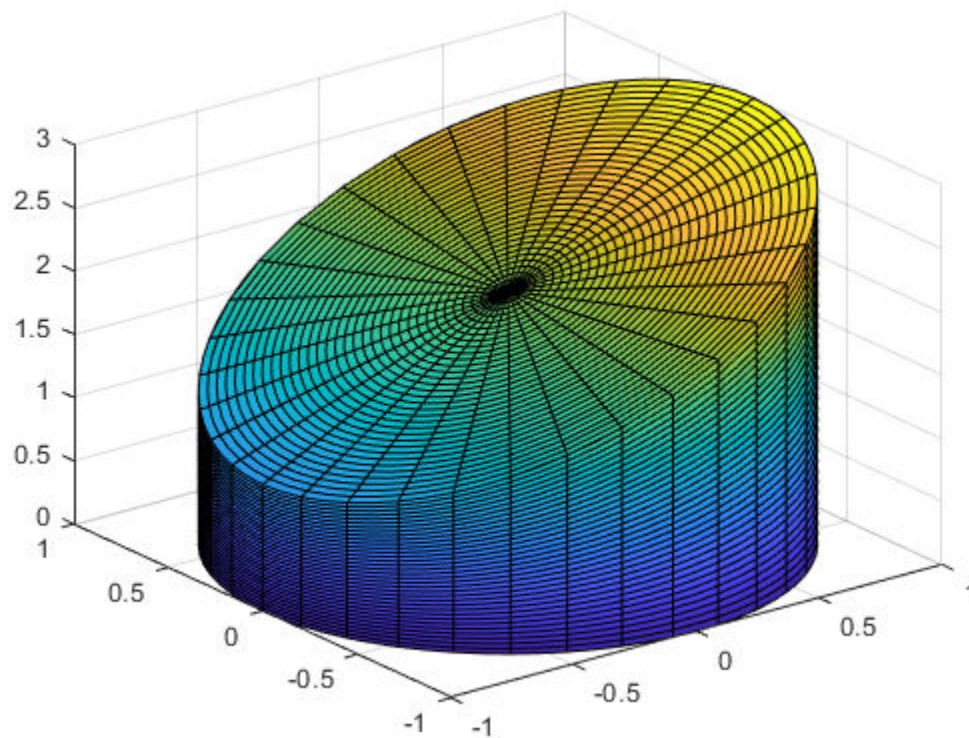

Apply Rotation and Translation to Surface Plot

Apply rotation and translation to the surface plot of a torus.

A torus can be defined parametrically by

$$x(\theta, \varphi) = (R + a \cos \theta) \cos \varphi$$

$$y(\theta, \varphi) = (R + a \cos \theta) \sin \varphi$$

$$z(\theta, \varphi) = a \sin \theta$$

where

- θ is the polar angle and φ is the azimuthal angle
- a is the radius of the tube
- R is the distance from the center of the tube to the center of the torus

Define the values for a and R as 1 and 5, respectively. Plot the torus using fsurf.

```
syms theta phi
a = 1;
R = 4;
x = (R + a*cos(theta))*cos(phi);
y = (R + a*cos(theta))*sin(phi);
z = a*sin(theta);
```

```
fsurf(x,y,z,[0 2*pi 0 2*pi])
hold on
```

Apply rotation to the torus around the x -axis. Define the rotation matrix. Rotate the torus by 90 degrees or $\pi/2$ radians.

```
alpha = pi/2;
Rx = [1 0 0;
      0 cos(alpha) -sin(alpha);
      0 sin(alpha) cos(alpha)];
r = [x; y; z];
r_90 = Rx*r;
```

Shift the center of the torus by 5 along the x -axis. Add a second plot of the rotated and translated torus to the existing graph.

```
fsurf(r_90(1)+5,r_90(2),r_90(3))
axis([-5 10 -5 10 -5 5])
hold off
```

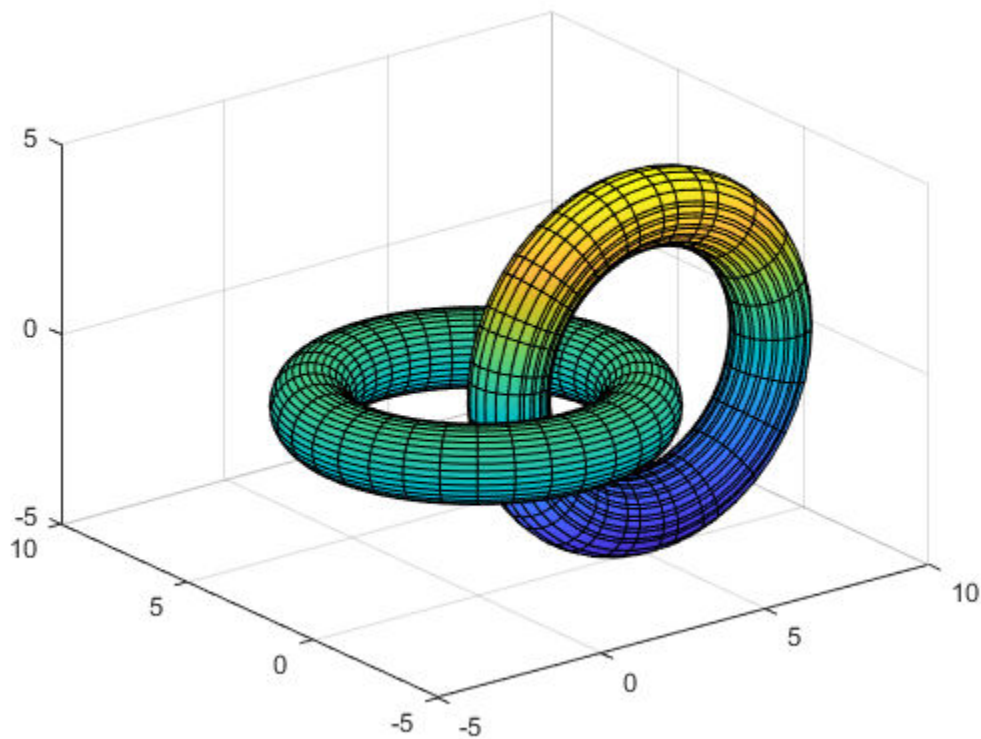

Input Arguments

f — 3-D expression or function to be plotted

symbolic expression | symbolic function

Expression or function to be plotted, specified as a symbolic expression or function.

[min max] — Plotting interval for x- and y-axes

[-5 5] (default) | vector of two numbers

Plotting interval for x- and y-axes, specified as a vector of two numbers. The default is [-5 5].

[xmin xmax ymin ymax] — Plotting interval for x- and y-axes

[-5 5 -5 5] (default) | vector of four numbers

Plotting interval for x- and y-axes, specified as a vector of four numbers. The default is [-5 5 -5 5].

funx, funy, funz — Parametric functions of u and v

symbolic expressions | symbolic functions

Parametric functions of u and v, specified as a symbolic expression or function.

[uvm in uvmax] — Plotting interval for u and v

[-5 5] (default) | vector of two numbers

Plotting interval for u and v axes, specified as a vector of two numbers. The default is [-5 5].

[umin umax vmin vmax] — Plotting interval for u and v

[-5 5 -5 5] (default) | vector of four numbers

Plotting interval for u and v, specified as a vector of four numbers. The default is [-5 5 -5 5].

ax — Axes object

axes object

Axes object. If you do not specify an axes object, then fsurf uses the current axes.

LineStyle — Line style, marker symbol, and face color

character vector

Line style, marker symbol, and color, specified as a character vector. The elements of the character vector can appear in any order, and you can omit one or more options from the character vector specifier.

Example: '- -or' is a red surface with circle markers and dashed lines

Specifier	Line Style
-	Solid line (default)
- -	Dashed line
:	Dotted line
- .	Dash-dot line

Specifier	Marker
o	Circle
+	Plus sign
*	Asterisk
.	Point
x	Cross

Specifier	Marker
s	Square
d	Diamond
^	Upward-pointing triangle
v	Downward-pointing triangle
>	Right-pointing triangle
<	Left-pointing triangle
p	Pentagram
h	Hexagram

Specifier	Color
y	yellow
m	magenta
c	cyan
r	red
g	green
b	blue
w	white
k	black

Name-Value Pair Arguments

Specify optional comma-separated pairs of `Name`, `Value` arguments. `Name` is the argument name and `Value` is the corresponding value. `Name` must appear inside quotes. You can specify several name and value pair arguments in any order as `Name1, Value1, ..., NameN, ValueN`.

Example: `'Marker', 'o', 'MarkerFaceColor', 'red'`

The properties listed here are only a subset. For a complete list, see `Function Surface`.

MeshDensity — Number of evaluation points per direction

35 (default) | number

Number of evaluation points per direction, specified as a number. The default is 35. Because `fsurf` objects use adaptive evaluation, the actual number of evaluation points is greater.

Example: 100

ShowContours — Display contour plot under plot

'off' (default) | on/off logical value

Display contour plot under plot, specified as `'on'` or `'off'`, or as numeric or logical 1 (true) or 0 (false). A value of `'on'` is equivalent to true, and `'off'` is equivalent to false. Thus, you can use the value of this property as a logical value. The value is stored as an on/off logical value of type `matlab.lang.OnOffSwitchState`.

EdgeColor — Line color









[0 0 0] (default) | 'interp' | RGB triplet | hexadecimal color code | 'r' | 'g' | 'b' | ...

Line color, specified as 'interp', an RGB triplet, a hexadecimal color code, a color name, or a short name. The default RGB triplet value of [0 0 0] corresponds to black. The 'interp' value colors the edges based on the ZData values.







For a custom color, specify an RGB triplet or a hexadecimal color code.

- An RGB triplet is a three-element row vector whose elements specify the intensities of the red, green, and blue components of the color. The intensities must be in the range [0, 1]; for example, [0.4 0.6 0.7].
- A hexadecimal color code is a character vector or a string scalar that starts with a hash symbol (#) followed by three or six hexadecimal digits, which can range from 0 to F. The values are not case sensitive. Thus, the color codes '#FF8800', '#ff8800', '#F80', and '#f80' are equivalent.

Alternatively, you can specify some common colors by name. This table lists the named color options, the equivalent RGB triplets, and hexadecimal color codes.

Color Name	Short Name	RGB Triplet	Hexadecimal Color Code	Appearance
'red'	'r'	[1 0 0]	'#FF0000'	
'green'	'g'	[0 1 0]	'#00FF00'	
'blue'	'b'	[0 0 1]	'#0000FF'	
'cyan'	'c'	[0 1 1]	'#00FFFF'	
'magenta'	'm'	[1 0 1]	'#FF00FF'	
'yellow'	'y'	[1 1 0]	'#FFFF00'	
'black'	'k'	[0 0 0]	'#000000'	
'white'	'w'	[1 1 1]	'#FFFFFF'	
'none'	Not applicable	Not applicable	Not applicable	No color



Here are the RGB triplets and hexadecimal color codes for the default colors MATLAB uses in many types of plots.

RGB Triplet	Hexadecimal Color Code	Appearance
[0 0.4470 0.7410]	'#0072BD'	
[0.8500 0.3250 0.0980]	'#D95319'	
[0.9290 0.6940 0.1250]	'#EDB120'	
[0.4940 0.1840 0.5560]	'#7E2F8E'	
[0.4660 0.6740 0.1880]	'#77AC30'	
[0.3010 0.7450 0.9330]	'#4DBEEE'	
[0.6350 0.0780 0.1840]	'#A2142F'	

LineStyle – Line style

'-' (default) | '--' | ':' | '-.' | 'none'

Line style, specified as one of the options listed in this table.

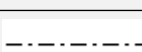
Line Style	Description	Resulting Line
'_'	Solid line	
'--'	Dashed line	
':'	Dotted line	
'-.'	Dash-dotted line	
'none'	No line	No line

LineWidth – Line width

0.5 (default) | positive value

Line width, specified as a positive value in points, where 1 point = 1/72 of an inch. If the line has markers, then the line width also affects the marker edges.

The line width cannot be thinner than the width of a pixel. If you set the line width to a value that is less than the width of a pixel on your system, the line displays as one pixel wide.

Marker – Marker symbol

'none' (default) | 'o' | '+' | '*' | '.' | 'x' | 's' | 'd' | ...

Marker symbol, specified as one of the values in this table. By default, a line does not have markers. Add markers at selected points along the line by specifying a marker.

Value	Description
'o'	Circle
'+'	Plus sign
'*'	Asterisk
'.'	Point
'x'	Cross
'square' or 's'	Square
'diamond' or 'd'	Diamond
'^'	Upward-pointing triangle
'v'	Downward-pointing triangle
'>'	Right-pointing triangle
'<'	Left-pointing triangle
'pentagram' or 'p'	Five-pointed star (pentagram)
'hexagram' or 'h'	Six-pointed star (hexagram)
'none'	No markers

MarkerEdgeColor – Marker outline color









'auto' (default) | RGB triplet | hexadecimal color code | 'r' | 'g' | 'b' | ...

Marker outline color, specified as 'auto', an RGB triplet, a hexadecimal color code, a color name, or a short name. The default value of 'auto' uses the same color as the EdgeColor property.







For a custom color, specify an RGB triplet or a hexadecimal color code.

- An RGB triplet is a three-element row vector whose elements specify the intensities of the red, green, and blue components of the color. The intensities must be in the range $[0, 1]$; for example, $[0.4 \ 0.6 \ 0.7]$.
- A hexadecimal color code is a character vector or a string scalar that starts with a hash symbol (#) followed by three or six hexadecimal digits, which can range from 0 to F. The values are not case sensitive. Thus, the color codes '#FF8800', '#ff8800', '#F80', and '#f80' are equivalent.

Alternatively, you can specify some common colors by name. This table lists the named color options, the equivalent RGB triplets, and hexadecimal color codes.

Color Name	Short Name	RGB Triplet	Hexadecimal Color Code	Appearance
'red'	'r'	[1 0 0]	'#FF0000'	
'green'	'g'	[0 1 0]	'#00FF00'	
'blue'	'b'	[0 0 1]	'#0000FF'	
'cyan'	'c'	[0 1 1]	'#00FFFF'	
'magenta'	'm'	[1 0 1]	'#FF00FF'	
'yellow'	'y'	[1 1 0]	'#FFFF00'	
'black'	'k'	[0 0 0]	'#000000'	
'white'	'w'	[1 1 1]	'#FFFFFF'	
'none'	Not applicable	Not applicable	Not applicable	No color

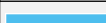
Here are the RGB triplets and hexadecimal color codes for the default colors MATLAB uses in many types of plots.

RGB Triplet	Hexadecimal Color Code	Appearance
[0 0.4470 0.7410]	'#0072BD'	
[0.8500 0.3250 0.0980]	'#D95319'	
[0.9290 0.6940 0.1250]	'#EDB120'	
[0.4940 0.1840 0.5560]	'#7E2F8E'	
[0.4660 0.6740 0.1880]	'#77AC30'	
[0.3010 0.7450 0.9330]	'#4DBEEE'	
[0.6350 0.0780 0.1840]	'#A2142F'	

Example: $[0.5 \ 0.5 \ 0.5]$

Example: 'blue'

Example: '#D2F9A7'

MarkerFaceColor — Marker fill color





'none' (default) | 'auto' | RGB triplet | hexadecimal color code | 'r' | 'g' | 'b' | ...

Marker fill color, specified as 'auto', an RGB triplet, a hexadecimal color code, a color name, or a short name. The 'auto' value uses the same color as the MarkerEdgeColor property.



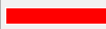

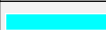
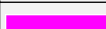
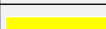

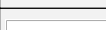
For a custom color, specify an RGB triplet or a hexadecimal color code.

- An RGB triplet is a three-element row vector whose elements specify the intensities of the red, green, and blue components of the color. The intensities must be in the range $[0, 1]$; for example, $[0.4 \ 0.6 \ 0.7]$.
- A hexadecimal color code is a character vector or a string scalar that starts with a hash symbol (#) followed by three or six hexadecimal digits, which can range from 0 to F. The values are not case sensitive. Thus, the color codes '#FF8800', '#ff8800', '#F80', and '#f80' are equivalent.

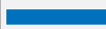
Alternatively, you can specify some common colors by name. This table lists the named color options, the equivalent RGB triplets, and hexadecimal color codes.

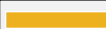
Color Name	Short Name	RGB Triplet	Hexadecimal Color Code	Appearance
'red'	'r'	[1 0 0]	'#FF0000'	
'green'	'g'	[0 1 0]	'#00FF00'	
'blue'	'b'	[0 0 1]	'#0000FF'	
'cyan'	'c'	[0 1 1]	'#00FFFF'	
'magenta'	'm'	[1 0 1]	'#FF00FF'	
'yellow'	'y'	[1 1 0]	'#FFFF00'	
'black'	'k'	[0 0 0]	'#000000'	
'white'	'w'	[1 1 1]	'#FFFFFF'	
'none'	Not applicable	Not applicable	Not applicable	No color

Here are the RGB triplets and hexadecimal color codes for the default colors MATLAB uses in many types of plots.

RGB Triplet	Hexadecimal Color Code	Appearance
[0 0.4470 0.7410]	'#0072BD'	
[0.8500 0.3250 0.0980]	'#D95319'	
[0.9290 0.6940 0.1250]	'#EDB120'	
[0.4940 0.1840 0.5560]	'#7E2F8E'	
[0.4660 0.6740 0.1880]	'#77AC30'	
[0.3010 0.7450 0.9330]	'#4DBEEE'	
[0.6350 0.0780 0.1840]	'#A2142F'	

Example: $[0.3 \ 0.2 \ 0.1]$

Example: 'green'

Example: '#D2F9A7'

MarkerSize — Marker size

6 (default) | positive value

Marker size, specified as a positive value in points, where 1 point = 1/72 of an inch.

Output Arguments

fs — One or more objects

scalar | vector

One or more objects, returned as a scalar or a vector. The object is either a function surface object or parameterized surface object, depending on the type of plot. You can use these objects to query and modify properties of a specific line. For details, see [Function Surface](#) and [Parameterized Function Surface](#).

Algorithms

`fsurf` assigns the symbolic variables in `f` to the `x` axis, then the `y` axis, and `symvar` determines the order of the variables to be assigned. Therefore, variable and axis names might not correspond. To force `fsurf` to assign `x` or `y` to its corresponding axis, create the symbolic function to plot, then pass the symbolic function to `fsurf`.

For example, the following code plots $f(x,y) = \sin(y)$ in two ways. The first way forces the waves to oscillate with respect to the `y` axis. The second way assigns `y` to the `x` axis because it is the first (and only) variable in the symbolic function.

```
syms x y;  
f(x,y) = sin(y);  
  
figure;  
subplot(2,1,1)  
fsurf(f);  
subplot(2,1,2)  
fsurf(f(x,y)); % Or fsurf(sin(y));
```

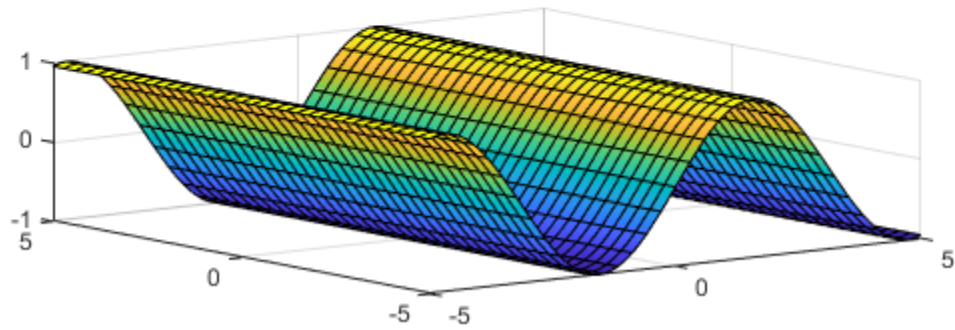
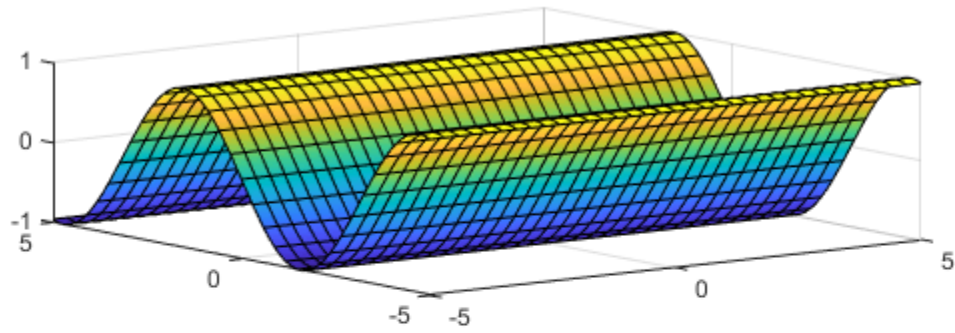

See Also

Functions

`fcontour` | `fimplicit` | `fimplicit3` | `fmesh` | `fplot` | `fplot3`

Properties

Function Surface | Parameterized Function Surface

Topics

“Create Plots” on page 2-229

Introduced in R2016a

functionalDerivative

Functional derivative

Syntax

```
D = functionalDerivative(f,y)
```

Description

`D = functionalDerivative(f,y)` returns the “Functional Derivative” on page 4-636 of the functional $F = \int f(x, y(x), y'(x)...)dx$ with respect to the function $y = y(x)$, where x represents one or more independent variables. If y is a vector of symbolic functions, `functionalDerivative` returns a vector of functional derivatives with respect to the functions in y , where all functions in y must depend on the same independent variables.

Examples

Find Functional Derivative

Find the functional derivative of the function given by $f(y) = y(x)\sin(y(x))$ with respect to the function y .

```
syms y(x)
f = y*sin(y);
D = functionalDerivative(f,y)

D(x) =
sin(y(x)) + cos(y(x))*y(x)
```

Find Functional Derivative of Vector of Functionals

Find the functional derivative of the function given by $H(u, v) = u^2 \frac{dv}{dx} + v \frac{d^2u}{dx^2}$ with respect to the functions u and v .

```
syms u(x) v(x)
H = u^2*diff(v,x)+v*diff(u,x,x);
D = functionalDerivative(H,[u v])

D(x) =
2*u(x)*diff(v(x), x) + diff(v(x), x, x)
diff(u(x), x, x) - 2*u(x)*diff(u(x), x)
```

`functionalDerivative` returns a vector of symbolic functions containing the functional derivatives of H with respect to u and v , respectively.

Find Euler-Lagrange Equation for Spring

First find the Lagrangian for a spring with mass m and spring constant k , and then derive the Euler-Lagrange equation. The Lagrangian is the difference of kinetic energy T and potential energy V which are functions of the displacement $x(t)$.

```

syms m k x(t)
T = sym(1)/2*m*diff(x,t)^2;
V = sym(1)/2*k*x^2;
L = T - V

L(t) =
(m*diff(x(t), t)^2)/2 - (k*x(t)^2)/2

```

Find the Euler-Lagrange equation by finding the functional derivative of L with respect to x , and equate it to 0 .

```

eqn = functionalDerivative(L,x) == 0

eqn(t) =
- m*diff(x(t), t, t) - k*x(t) == 0

```

$\text{diff}(x(t), t, t)$ is the acceleration. The equation eqn represents the expected differential equation that describes spring motion.

Solve eqn using `dsolve`. Obtain the expected form of the solution by assuming mass m and spring constant k are positive.

```

assume(m,'positive')
assume(k,'positive')
xSol = dsolve(eqn,x(0) == 0)

xSol =
-C3*sin((k^(1/2)*t)/m^(1/2))

```

Clear assumptions for further calculations.

```
assume([k m], 'clear')
```

Find Differential Equation for Brachistochrone Problem

The Brachistochrone problem is to find the quickest path of descent under gravity. The time for a body to move along a curve $y(x)$ under gravity is given by

$$f = \sqrt{\frac{1 + y'^2}{2gy}},$$

where g is the acceleration due to gravity.

Find the quickest path by minimizing f with respect to the path y . The condition for a minimum is

$$\frac{\delta f}{\delta y} = 0.$$

Compute this condition to obtain the differential equation that describes the Brachistochrone problem. Use `simplify` to simplify the solution to its expected form.

```

syms g y(x)
assume(g,'positive')
f = sqrt((1+diff(y)^2)/(2*g*y));
eqn = functionalDerivative(f,y) == 0;
eqn = simplify(eqn)

```



```
eqn(x) =
diff(y(x), x)^2 + 2*y(x)*diff(y(x), x, x) == -1
```

This equation is the standard differential equation for the Brachistochrone problem.

Find Minimal Surface in 3-D Space

If the function $u(x,y)$ describes a surface in 3-D space, then the surface area is found by the functional

$$F(u) = \iint f(x, y, u, u_x, u_y) dx dy = \iint \sqrt{1 + u_x^2 + u_y^2} dx dy,$$

where u_x and u_y are the partial derivatives of u with respect to x and y .

Find the equation that describes the minimal surface for a 3-D surface described by the function $u(x, y)$ by finding the functional derivative of f with respect to u .

```
syms u(x,y)
f = sqrt(1 + diff(u,x)^2 + diff(u,y)^2);
D = functionalDerivative(f,u)

D(x, y) =
-(diff(u(x, y), y)^2*diff(u(x, y), x, x)...
+ diff(u(x, y), x)^2*diff(u(x, y), y, y)...
- 2*diff(u(x, y), x)*diff(u(x, y), y)*diff(u(x, y), x, y)...
+ diff(u(x, y), x, x)...
+ diff(u(x, y), y, y))/(diff(u(x, y), x)^2...
+ diff(u(x, y), y)^2 + 1)^(3/2)
```

The solutions to this equation D describe minimal surfaces in 3-D space such as soap bubbles.

Input Arguments

f — Expression to find functional derivative of

symbolic variable | symbolic function | symbolic expression

Expression to find functional derivative of, specified as a symbolic variable, function, or expression. The argument f represents the density of the functional.

y — Differentiation function

symbolic function | vector of symbolic functions | matrix of symbolic functions | multidimensional array of symbolic functions

Differentiation function, specified as a symbolic function or a vector, matrix, or multidimensional array of symbolic functions. The argument y can be a function of one or more independent variables. If y is a vector of symbolic functions, `functionalDerivative` returns a vector of functional derivatives with respect to the functions in y , where all functions in y must depend on the same independent variables.

Output Arguments

D — Functional derivative

symbolic function | vector of symbolic functions

Functional derivative, returned as a symbolic function or a vector of symbolic functions. If input y is a vector, then D is a vector.

More About

Functional Derivative

Consider functionals

$$F(y) = \int_{\Omega} f(x, y(x), y'(x), y''(x), \dots) dx,$$

where Ω is a region in x -space.

For a small change in the value of y , δy , the change in the functional F is

$$\frac{\delta F}{\delta y} = \left. \frac{d}{d\varepsilon} \right|_{\varepsilon=0} F(y + \varepsilon \delta y) = \int_{\Omega} \frac{\delta f(x)}{\delta y} \delta y(x) dx + \text{boundary terms.}$$

The expression $\frac{\delta f(x)}{\delta y}$ is the functional derivative of f with respect to y .

See Also

`diff` | `dsolve` | `int`

Topics

“Functional Derivatives Tutorial” on page 2-51

Introduced in R2015a

funm

General matrix function

Syntax

`F = funm(A, f)`

Description

`F = funm(A, f)` computes the function $f(A)$ for the square matrix A . For details, see “Matrix Function” on page 4-640.

Examples

Matrix Cube Root

Find matrix B , such that $B^3 = A$, where A is a 3-by-3 identity matrix.

To solve $B^3 = A$, compute the cube root of the matrix A using the `funm` function. Create the symbolic function $f(x) = x^{1/3}$ and use it as the second argument for `funm`. The cube root of an identity matrix is the identity matrix itself.

```
A = sym(eye(3))
```

```
syms f(x)
f(x) = x^(1/3);
```

```
B = funm(A, f)
```

```
A =
[ 1, 0, 0]
[ 0, 1, 0]
[ 0, 0, 1]
```

```
B =
[ 1, 0, 0]
[ 0, 1, 0]
[ 0, 0, 1]
```

Replace one of the 0 elements of matrix A with 1 and compute the matrix cube root again.

```
A(1,2) = 1
B = funm(A, f)
```

```
A =
[ 1, 1, 0]
[ 0, 1, 0]
[ 0, 0, 1]
```

```
B =
[ 1, 1/3, 0]
[ 0, 1, 0]
[ 0, 0, 1]
```

Now, compute the cube root of the upper triangular matrix.

```
A(1:2,2:3) = 1
B = funm(A, f)
```

```
A =
[ 1, 1, 1]
[ 0, 1, 1]
[ 0, 0, 1]
```

```
B =
[ 1, 1/3, 2/9]
[ 0, 1, 1/3]
[ 0, 0, 1]
```

Verify that $B^3 = A$.

```
B^3
```

```
ans =
[ 1, 1, 1]
[ 0, 1, 1]
[ 0, 0, 1]
```

Matrix Lambert W Function

Find the matrix Lambert W function.

First, create a 3-by-3 matrix A using variable-precision arithmetic with five digit accuracy. In this example, using variable-precision arithmetic instead of exact symbolic numbers lets you speed up computations and decrease memory usage. Using only five digits helps the result to fit on screen.

```
savedefault = digits(5);
A = vpa(magic(3))
```

```
A =
[ 8.0, 1.0, 6.0]
[ 3.0, 5.0, 7.0]
[ 4.0, 9.0, 2.0]
```

Create the symbolic function $f(x) = \text{lambertw}(x)$.

```
syms f(x)
f(x) = lambertw(x);
```

To find the Lambert W function (W_0 branch) in a matrix sense, call `funm` using $f(x)$ as its second argument.

```
W0 = funm(A, f)
```

```
W0 =
[ 1.5335 + 0.053465i, 0.11432 + 0.47579i, 0.36208 - 0.52925i]
[ 0.21343 + 0.073771i, 1.3849 + 0.65649i, 0.41164 - 0.73026i]
[ 0.26298 - 0.12724i, 0.51074 - 1.1323i, 1.2362 + 1.2595i]
```

Verify that this result is a solution of the matrix equation $A = W_0 \cdot e^{W_0}$ within the specified accuracy.

```
W0*expm(W0)
```

```
ans =
[      8.0, 1.0 - 5.6843e-13i, 6.0 + 1.1369e-13i]
[ 3.0 - 2.2737e-13i, 5.0 - 2.8422e-14i, 7.0 - 4.1211e-13i]
[ 4.0 - 2.2737e-13i, 9.0 - 9.9476e-14i, 2.0 + 1.4779e-12i]
```

Now, create the symbolic function $f(x)$ representing the branch W_{-1} of the Lambert W function.

```
f(x) = lambertw(-1,x);
```

Find the W_{-1} branch for the matrix A.

```
Wm1 = funm(A, f)
```

```
Wm1 =
[ 0.40925 - 4.7154i, 0.54204 + 0.5947i, 0.13764 - 0.80906i]
[ 0.38028 + 0.033194i, 0.65189 - 3.8732i, 0.056763 - 1.0898i]
[ 0.2994 - 0.24756i, - 0.105 - 1.6513i, 0.89453 - 3.0309i]
```

Verify that this result is the solution of the matrix equation $A = Wm1 \cdot e^{Wm1}$ within the specified accuracy.

```
Wm1*expm(Wm1)
```

```
ans =
[ 8.0 - 8.3844e-13i, 1.0 - 3.979e-13i, 6.0 - 9.0949e-13i]
[ 3.0 - 9.6634e-13i, 5.0 + 1.684e-12i, 7.0 + 4.5475e-13i]
[ 4.0 - 1.3642e-12i, 9.0 + 1.6698e-12i, 2.0 + 1.7053e-13i]
```

Matrix Exponential, Logarithm, and Square Root

You can use `funm` with appropriate second arguments to find matrix exponential, logarithm, and square root. However, the more efficient approach is to use the functions `expm`, `logm`, and `sqrtn` for this task.

Create this square matrix and find its exponential, logarithm, and square root.

```
syms x
A = [1 -1; 0 x]
expA = expm(A)
logA = logm(A)
sqrA = sqrtn(A)

A =
[ 1, -1]
[ 0, x]

expA =
[ exp(1), (exp(1) - exp(x))/(x - 1)]
[ 0, exp(x)]

logA =
[ 0, -log(x)/(x - 1)]
[ 0, log(x)]

sqrA =
[ 1, 1/(x - 1) - x^(1/2)/(x - 1)]
[ 0, x^(1/2)]
```

Find the matrix exponential, logarithm, and square root of A using `funm`. Use the symbolic expressions `exp(x)`, `log(x)`, and `sqrt(x)` as the second argument of `funm`. The results are identical.

```
expA = funm(A,exp(x))
logA = funm(A,log(x))
sqrtA = funm(A,sqrt(x))

expA =
[ exp(1), exp(1)/(x - 1) - exp(x)/(x - 1)]
[      0,                               exp(x)]

logA =
[ 0, -log(x)/(x - 1)]
[ 0,      log(x)]

sqrtA =
[ 1, 1/(x - 1) - x^(1/2)/(x - 1)]
[ 0,                x^(1/2)]
```

Input Arguments

A — Input matrix

square matrix

Input matrix, specified as a square symbolic or numeric matrix.

f — Function

symbolic function | symbolic expression

Function, specified as a symbolic function or expression.

Output Arguments

F — Resulting matrix

symbolic matrix

Resulting function, returned as a symbolic matrix.

More About

Matrix Function

Matrix function is a scalar function that maps one matrix to another.

Suppose, $f(x)$, where x is a scalar, has a Taylor series expansion. Then the matrix function $f(A)$, where A is a matrix, is defined by the Taylor series of $f(A)$, with addition and multiplication performed in the matrix sense.

If A can be represented as $A = P \cdot D \cdot P^{-1}$, where D is a diagonal matrix, such that

$$D = \begin{pmatrix} d_1 & \cdots & 0 \\ \vdots & \ddots & \vdots \\ 0 & \cdots & d_n \end{pmatrix}$$

then the matrix function $f(A)$ can be computed as follows:

$$f(A) = P \cdot \begin{pmatrix} f(d_1) & \cdots & 0 \\ \vdots & \ddots & \vdots \\ 0 & \cdots & f(d_n) \end{pmatrix} \cdot P^{-1}$$

Non-diagonalizable matrices can be represented as $A = P \cdot J \cdot P^{-1}$, where J is a Jordan form of the matrix A . Then, the matrix function $f(A)$ can be computed by using the following definition on each Jordan block:

$$f \left(\begin{pmatrix} \lambda & 1 & 0 & \cdots & 0 \\ 0 & \ddots & \ddots & \ddots & \vdots \\ \vdots & \ddots & \ddots & \ddots & 0 \\ \vdots & \ddots & \ddots & \ddots & 1 \\ 0 & \cdots & \cdots & 0 & \lambda \end{pmatrix} \right) = \begin{pmatrix} \frac{f(\lambda)}{0!} & \frac{f'(\lambda)}{1!} & \frac{f''(\lambda)}{2!} & \cdots & \frac{f^{(n-1)}(\lambda)}{(n-1)!} \\ 0 & \ddots & \ddots & \ddots & \vdots \\ \vdots & \ddots & \ddots & \ddots & \frac{f''(\lambda)}{2!} \\ \vdots & \ddots & \ddots & \ddots & \frac{f'(\lambda)}{1!} \\ 0 & \cdots & \cdots & 0 & \frac{f(\lambda)}{0!} \end{pmatrix}$$

Tips

- For compatibility with the MATLAB `funm` function, `funm` accepts the following arguments:
 - Function handles such as `@exp` and `@sin`, as its second input argument.
 - The `options` input argument, such as `funm(A, f, options)`.
 - Additional input arguments of the function `f`, such as `funm(A, f, options, p1, p2, ...)`
 - The `exitflag` output argument, such as `[F, exitflag] = funm(A, f)`. Here, `exitflag` is 1 only if the `funm` function call errors, for example, if it encounters a division by zero. Otherwise, `exitflag` is 0.

For more details and a list of all acceptable function handles, see the MATLAB `funm` function.

- If the input matrix A is numeric (not a symbolic object) and the second argument `f` is a function handle, then the `funm` call invokes the MATLAB `funm` function.

See Also

`eig` | `expm` | `jordan` | `logm` | `sqrtn`

Introduced in R2014b

funtool

Function calculator

Description

The `funtool` app is a visual function calculator that manipulates and displays functions of one variable. At the click of a button, for example, `funtool` draws a graph representing the sum, product, difference, or ratio of two functions that you specify. `funtool` includes a function memory that allows you to store functions for later retrieval.

Open the funtool

At startup, `funtool` displays graphs of a pair of functions, $f(x) = x$ and $g(x) = 1$. The graphs plot the functions over the domain $[-2\pi, 2\pi]$. `funtool` also displays a control panel that lets you save, retrieve, redefine, combine, and transform f and g .

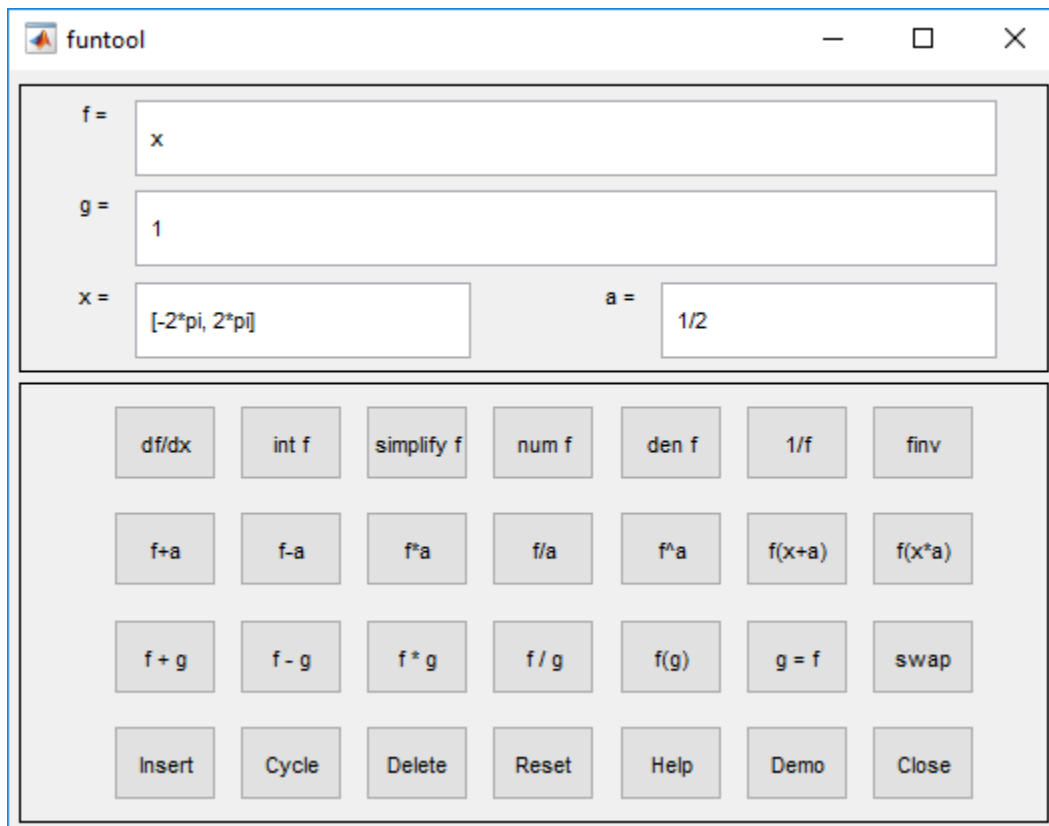

The top of the control panel contains a group of editable text fields.

f=	Displays a symbolic expression representing f . Edit this field to redefine f .
g=	Displays a symbolic expression representing g . Edit this field to redefine g .

x=	Displays the domain used to plot f and g . Edit this field to specify a different domain.
a=	Displays a constant factor used to modify f (see button descriptions in the next section). Edit this field to change the value of the constant factor.

funtool redraws f and g to reflect any changes you make to the contents of the control panel's text fields.

The bottom part of the control panel contains an array of buttons that transform f and perform other operations.

The first row of control buttons replaces f with various transformations of f .

df/dx	Derivative of f
int f	Integral of f
simplify f	Simplified form of f , if possible
num f	Numerator of f
den f	Denominator of f
1/f	Reciprocal of f

finv	Inverse of f	
	The operators int f and finv can fail if the corresponding symbolic expressions do not exist in closed form.	
	The second row of buttons translates and scales f and the domain of f by a constant factor. To specify the factor, enter its value in the field labeled a= on the calculator control panel. The operations are	
	f+a	Replaces f(x) by f(x) + a.
	f-a	Replaces f(x) by f(x) - a.
	f*a	Replaces f(x) by f(x) * a.
	f/a	Replaces f(x) by f(x) / a.
	f^a	Replaces f(x) by f(x) ^ a.
	f(x+a)	Replaces f(x) by f(x + a).
	f(x*a)	Replaces f(x) by f(x * a).
	The first four buttons of the third row replace f with a combination of f and g.	
	f+g	Replaces f(x) by f(x) + g(x).
	f-g	Replaces f(x) by f(x) - g(x).
	f*g	Replaces f(x) by f(x) * g(x).
	f/g	Replaces f(x) by f(x) / g(x).
	The remaining buttons on the third row interchange f and g.	
	g=f	Replaces g with f.
	swap	Replaces f with g and g with f.
	The first three buttons in the fourth row allow you to store and retrieve functions from the calculator's function memory.	
	Insert	Adds f to the end of the list of stored functions.
	Cycle	Replaces f with the next item on the function list.
	Delete	Deletes f from the list of stored functions.
	The other four buttons on the fourth row perform miscellaneous functions:	
Reset	Resets the calculator to its initial state.	
Help	Displays the online help for the calculator.	
Demo	Runs a short demo of the calculator.	
Close	Closes the calculator's windows.	

Examples

Display Quadratic Function and Its Derivative

Display a quadratic function by editing the text field $f = x^2 + 2x + 1$. Plot the quadratic function within the interval $x = [-5, 5]$.

The screenshot shows the 'funtool' application window. The interface is divided into two main sections. The top section contains three text input fields: 'f =' with the value $x^2 + 2x + 1$, 'g =' with the value 1, and 'x =' with the value [-5 5]. To the right of the 'x =' field is an 'a =' field with the value 1/2. The bottom section is a grid of buttons for various mathematical operations. The buttons are arranged in four rows and seven columns:

df/dx	int f	simplify f	num f	den f	1/f	finv
f+a	f-a	f*a	f/a	f^a	f(x+a)	f(x^a)
f+g	f-g	f*g	f/g	f(g)	g=f	swap
Insert	Cycle	Delete	Reset	Help	Demo	Close

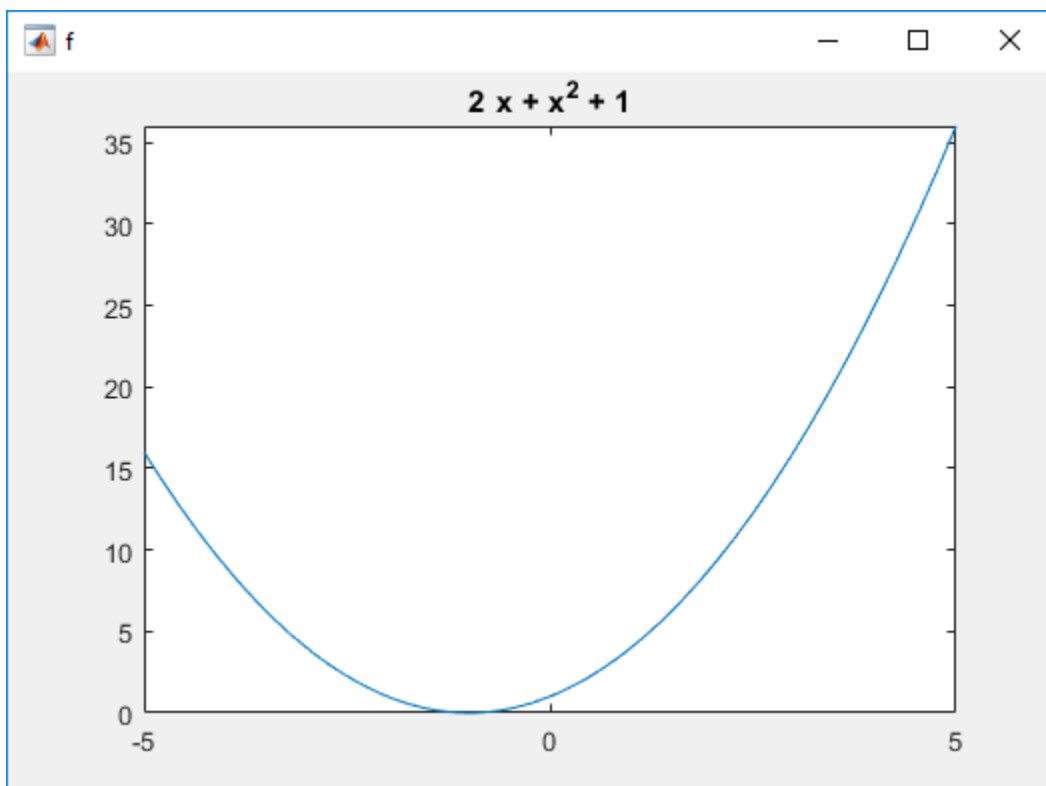

Click **df/dx** to find the derivative of the quadratic function.

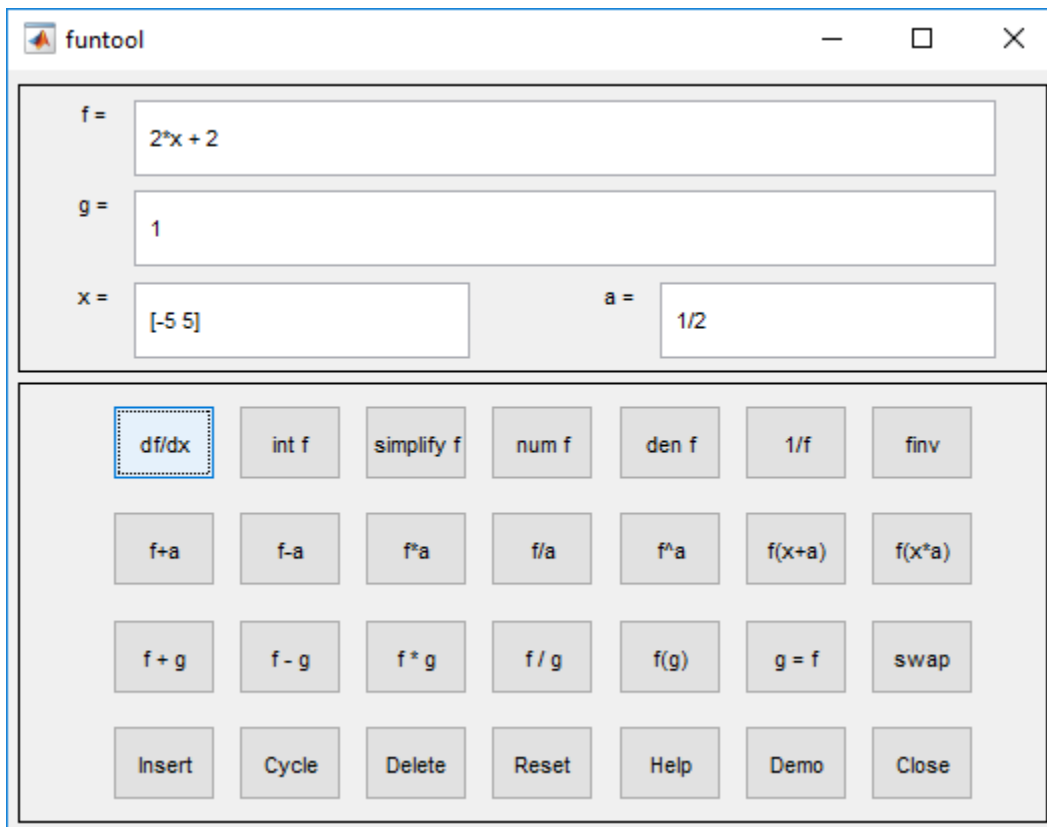

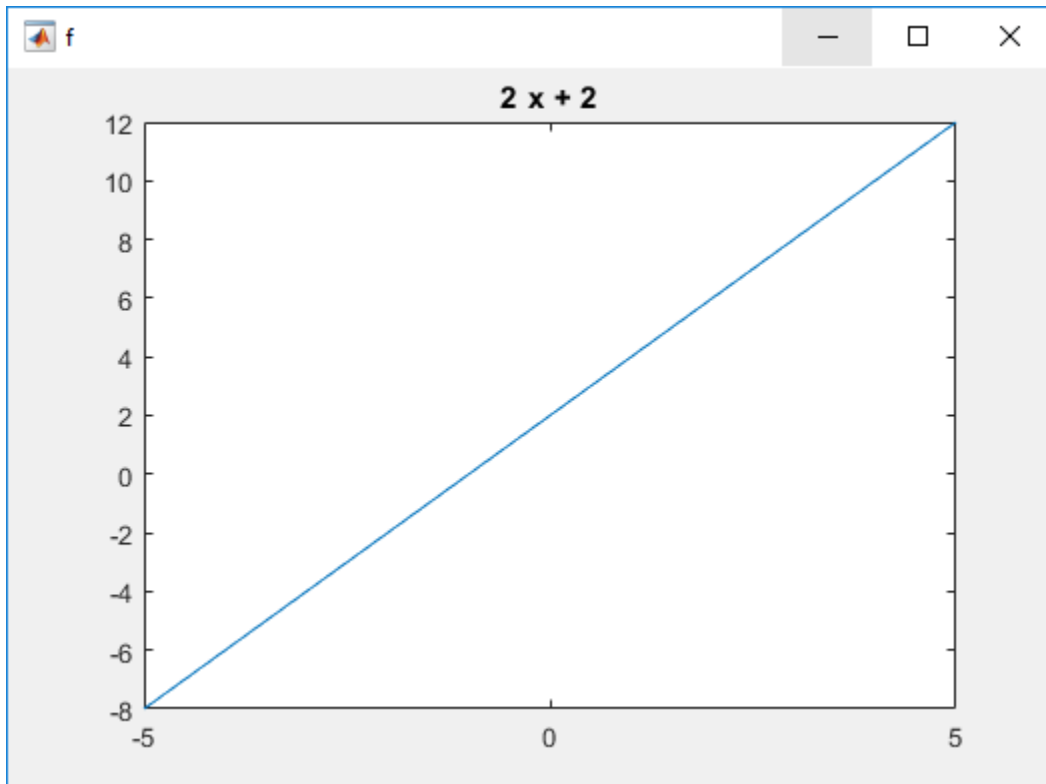

See Also

`fplot` | `rsums` | `syms` | `taylor`

Introduced before R2006a

gamma

Gamma function

Syntax

`gamma(X)`

Description

`gamma(X)` returns the gamma function on page 4-651 of a symbolic variable or symbolic expression `X`.

Examples

Gamma Function for Numeric and Symbolic Arguments

Depending on its arguments, `gamma` returns floating-point or exact symbolic results.

Compute the gamma function for these numbers. Because these numbers are not symbolic objects, you get floating-point results.

```
A = gamma([-11/3, -7/5, -1/2, 1/3, 1, 4])
```

```
A =
    0.2466    2.6593   -3.5449    2.6789    1.0000    6.0000
```

Compute the gamma function for the numbers converted to symbolic objects. For many symbolic (exact) numbers, `gamma` returns unresolved symbolic calls.

```
symA = gamma(sym([-11/3, -7/5, -1/2, 1/3, 1, 4]))
```

```
symA =
[ (27*pi^3^(1/2))/(440*gamma(2/3)), gamma(-7/5), ...
-2*pi^(1/2), (2*pi^3^(1/2))/(3*gamma(2/3)), 1, 6]
```

Use `vpa` to approximate symbolic results with floating-point numbers:

```
vpa(symA)
```

```
ans =
[ 0.24658411512650858900694446388517, ...
2.6592718728800305399898810505738, ...
-3.5449077018110320545963349666823, ...
2.6789385347077476336556929409747, ...
1.0, 6.0]
```

Plot Gamma Function

Plot the gamma function and add grid lines.

```
syms x
fplot(gamma(x))
grid on
```

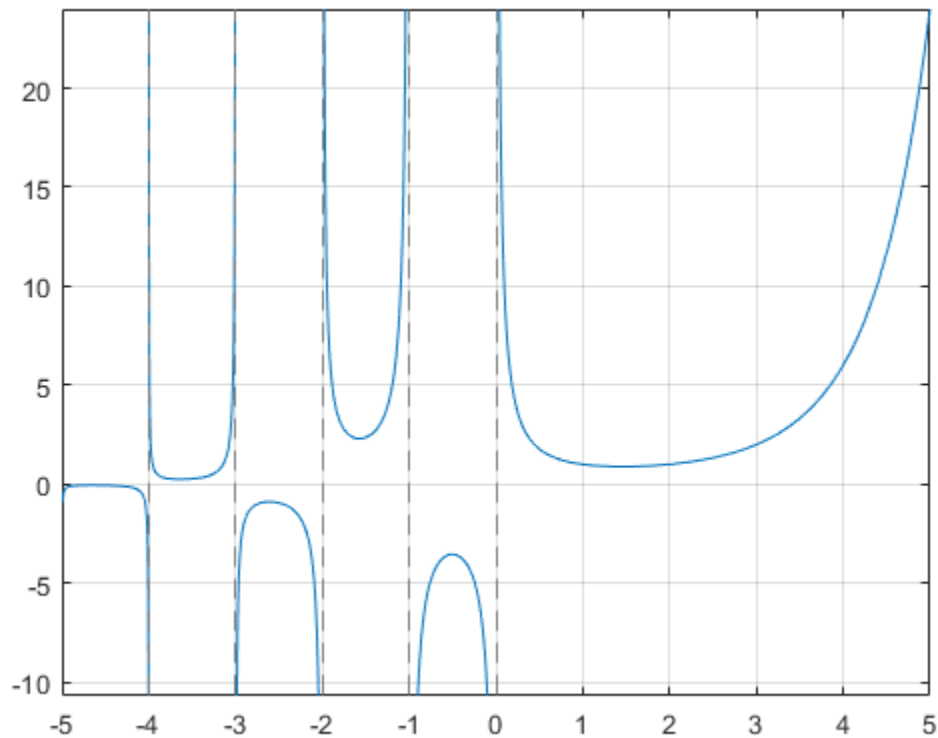

Handle Expressions Containing Gamma Function

Many functions, such as `diff`, `limit`, and `simplify`, can handle expressions containing gamma.

Differentiate the gamma function, and then substitute the variable t with the value 1:

```
syms t
u = diff(gamma(t^3 + 1))
u1 = subs(u, t, 1)

u =
3*t^2*gamma(t^3 + 1)*psi(t^3 + 1)

u1 =
3 - 3*eulergamma
```

Approximate the result using `vpa`:

```
vpa(u1)

ans =
1.2683530052954014181804637297528
```

Compute the limit of the following expression that involves the gamma function:

```
syms x
limit(x/gamma(x), x, inf)
```



```
ans =  
0
```

Simplify the following expression:

```
syms x  
simplify(gamma(x)*gamma(1 - x))
```

```
ans =  
pi/sin(pi*x)
```

Input Arguments

X — Input

symbolic number | symbolic variable | symbolic expression | symbolic function | symbolic vector | symbolic matrix

Input, specified as symbolic number, variable, expression, function, or as a vector or matrix of symbolic numbers, variables, expressions, or functions.

More About

Gamma Function

The following integral defines the gamma function:

$$\Gamma(z) = \int_0^{\infty} t^{z-1} e^{-t} dt.$$

See Also

beta | factorial | gamma|ln | igamma | nchoosek | pochhammer | psi

Introduced before R2006a

gammaln

Logarithmic gamma function

Syntax

`gammaln(X)`

Description

`gammaln(X)` returns the logarithmic gamma function for each element of X .

Examples

Logarithmic Gamma Function for Numeric and Symbolic Arguments

Depending on its arguments, `gammaln` returns floating-point or exact symbolic results.

Compute the logarithmic gamma function for these numbers. Because these numbers are not symbolic objects, you get floating-point results.

```
A = gammaln([1/5, 1/2, 2/3, 8/7, 3])
```

```
A =
    1.5241    0.5724    0.3032   -0.0667    0.6931
```

Compute the logarithmic gamma function for the numbers converted to symbolic objects. For many symbolic (exact) numbers, `gammaln` returns results in terms of the `gammaln`, `log`, and `gamma` functions.

```
symA = gammaln(sym([1/5, 1/2, 2/3, 8/7, 3]))
```

```
symA =
[ gammaln(1/5), log(pi^(1/2)), gammaln(2/3),...
  log(gamma(1/7)/7), log(2)]
```

Use `vpa` to approximate symbolic results with floating-point numbers:

```
vpa(symA)
```

```
ans =
[ 1.5240638224307845248810564939263,...
  0.57236494292470008707171367567653,...
  0.30315027514752356867586281737201,...
 -0.066740877459477468649396334098109,...
  0.69314718055994530941723212145818]
```

Definition of the Logarithmic Gamma Function on Complex Plane

`gammaln` is defined for all complex arguments, except negative infinity.

Compute the logarithmic gamma function for positive integer arguments. For such arguments, the logarithmic gamma function is defined as the natural logarithm of the gamma function, `gammaln(x) = log(gamma(x))`.

```
pos = gammaln(sym([1/4, 1/3, 1, 5, Inf]))
```

```
pos =
[ log((pi*2^(1/2))/gamma(3/4)), log((2*pi*3^(1/2))/(3*gamma(2/3))), 0, log(24), Inf]
```

Compute the logarithmic gamma function for nonpositive integer arguments. For nonpositive integers, `gammaln` returns `Inf`.

```
nonposint = gammaln(sym([0, -1, -2, -5, -10]))
```

```
nonposint =
[ Inf, Inf, Inf, Inf, Inf]
```

Compute the logarithmic gamma function for complex and negative rational arguments. For these arguments, `gammaln` returns unresolved symbolic calls.

```
complex = gammaln(sym([i, -1 + 2*i, -2/3, -10/3]))
```

```
complex =
[ gammaln(1i), gammaln(- 1 + 2i), gammaln(-2/3), gammaln(-10/3)]
```

Use `vpa` to approximate symbolic results with floating-point numbers:

```
vpa(complex)
```

```
ans =
[ - 0.65092319930185633888521683150395 - 1.8724366472624298171188533494366i,...
- 3.3739449232079248379476073664725 - 3.4755939462808110432931921583558i,...
1.3908857550359314511651871524423 - 3.1415926535897932384626433832795i,...
- 0.93719017334928727370096467598178 - 12.566370614359172953850573533118i]
```

Compute the logarithmic gamma function of negative infinity:

```
gammaln(sym(-Inf))
```

```
ans =
NaN
```

Plot Logarithmic Gamma Function

Plot the logarithmic gamma function on the interval from 0 to 10.

```
syms x
fplot(gammaln(x),[0 10])
grid on
```

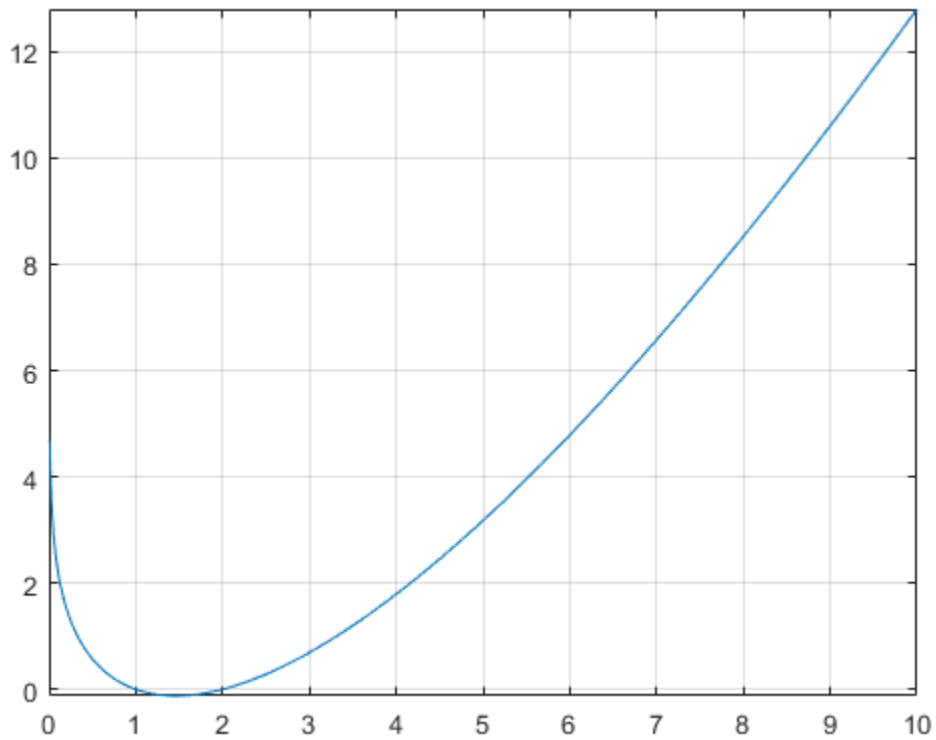

To see the negative values better, plot the same function on the interval from 1 to 2.

```
fplot(gamma ln(x), [1 2])  
grid on
```

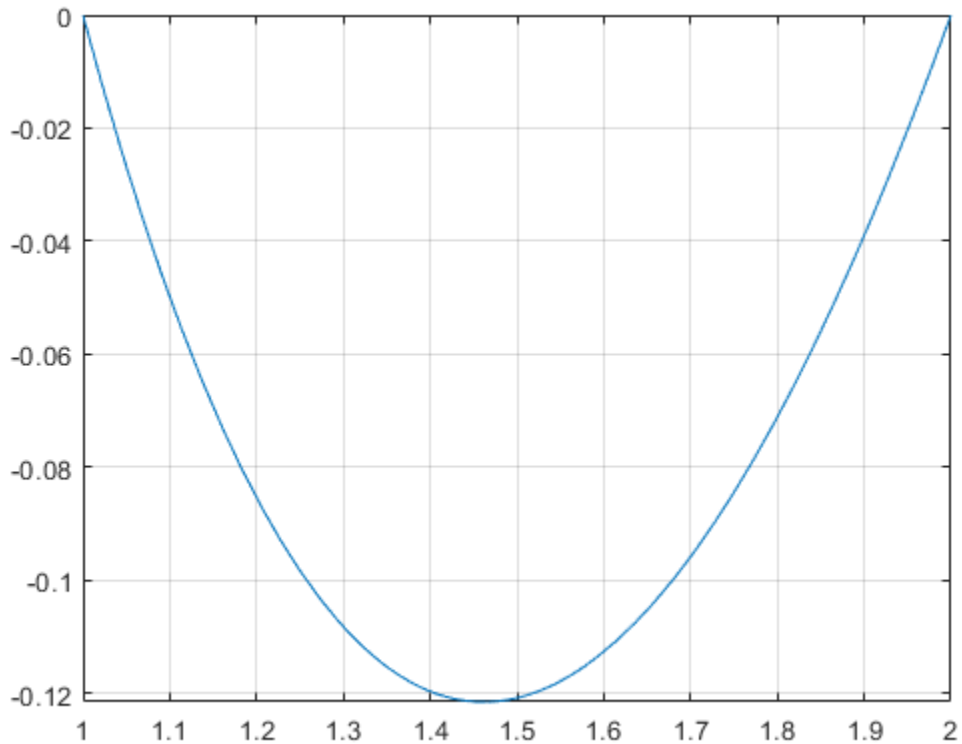

Handle Expressions Containing Logarithmic Gamma Function

Many functions, such as `diff` and `limit`, can handle expressions containing `lgamma`.

Differentiate the logarithmic gamma function:

```
syms x
diff(gammaln(x), x)
```

```
ans =
psi(x)
```

Compute the limits of these expressions containing the logarithmic gamma function:

```
syms x
limit(1/gammaln(x), x, Inf)
```

```
ans =
0
```

```
limit(gammaln(x - 1) - gammaln(x - 2), x, 0)
```

```
ans =
log(2) + pi*1i
```

Input Arguments

X — Input

symbolic number | symbolic variable | symbolic expression | symbolic function | symbolic vector | symbolic matrix

Input, specified as symbolic number, variable, expression, function, or as a vector or matrix of symbolic numbers, variables, expressions, or functions.

Algorithms

For single or double input to `gammaIn(x)`, x must be real and positive.

For symbolic input,

- `gammaIn(x)` is defined for all complex x except the singular points $0, -1, -2, \dots$.
- For positive real x , `gammaIn(x)` represents the logarithmic gamma function `log(gamma(x))`.
- For negative real x or for complex x , `gammaIn(x) = log(gamma(x)) + f(x)2πi` where $f(x)$ is some integer valued function. The integer multiples of $2\pi i$ are chosen such that `gammaIn(x)` is analytic throughout the complex plane with a branch cut along the negative real semi axis.
- For negative real x , `gammaIn(x)` is equal to the limit of `log(gamma(x))` from 'above'.

See Also

beta | gamma | log | nchoosek | psi

Introduced in R2014a

gcd

GCD of numbers and polynomials

Syntax

```
G = gcd(A)
G = gcd(A,B)
[G,M] = gcd(A)
[G,C,D] = gcd(A,B,X)
```

Description

$G = \text{gcd}(A)$ finds the greatest common divisor of all elements of A .

$G = \text{gcd}(A,B)$ finds the greatest common divisor of A and B .

$[G,M] = \text{gcd}(A)$ returns the GCD G of all elements of A , and returns in M the linear combination of A that equals G .

$[G,C,D] = \text{gcd}(A,B,X)$ finds the greatest common divisor of A and B , and also returns the Bézout coefficients, C and D , such that $G = A*C + B*D$. For multivariate expressions, specify the polynomial variable X such that it does not appear in the denominator of C and D . If you do not specify X , then `gcd` uses the default variable determined by `symvar`.

Examples

Greatest Common Divisor of Four Integers

To find the greatest common divisor of three or more values, specify those values as a symbolic vector or matrix.

Find the greatest common divisor of these four integers, specified as elements of a symbolic vector.

```
A = sym([4420, -128, 8984, -488])
gcd(A)
```

```
A =
[ 4420, -128, 8984, -488]
```

```
ans =
4
```

Alternatively, specify these values as elements of a symbolic matrix.

```
A = sym([4420, -128; 8984, -488])
gcd(A)
```

```
A =
[ 4420, -128]
[ 8984, -488]
```

```
ans =
4
```

Greatest Common Divisor of Polynomials

Find the greatest common divisor of univariate and multivariate polynomials.

Find the greatest common divisor of these univariate polynomials.

```
syms x
gcd(x^3 - 3*x^2 + 3*x - 1, x^2 - 5*x + 4)
```

```
ans =
x - 1
```

Find the greatest common divisor of these multivariate polynomials. Because there are more than two polynomials, specify them as elements of a symbolic vector.

```
syms x y
gcd([x^2*y + x^3, (x + y)^2, x^2 + x*y^2 + x*y + x + y^3 + y])
```

```
ans =
x + y
```

Greatest Common Divisor of Rational Numbers

The greatest common divisor of rational numbers a_1, a_2, \dots is a number g , such that $g/a_1, g/a_2, \dots$ are integers, and $\gcd(g/a_1, g/a_2, \dots) = 1$.

Find the greatest common divisor of these rational numbers, specified as elements of a symbolic vector.

```
gcd(sym([1/4, 1/3, 1/2, 2/3, 3/4]))
```

```
ans =
1/12
```

Greatest Common Divisor of Complex Numbers

`gcd` computes the greatest common divisor of complex numbers over the Gaussian integers (complex numbers with integer real and imaginary parts). It returns a complex number with a positive real part and a nonnegative imaginary part.

Find the greatest common divisor of these complex numbers.

```
gcd(sym([10 - 5*i, 20 - 10*i, 30 - 15*i]))
```

```
ans =
5 + 10i
```

Greatest Common Divisor of Elements of Matrices

For vectors and matrices, `gcd` finds the greatest common divisors element-wise. Nonscalar arguments must be the same size.

Find the greatest common divisors for the elements of these two matrices.

```
A = sym([309, 186; 486, 224]);
B = sym([558, 444; 1024, 1984]);
gcd(A,B)
```

```
ans =
 [ 3,  6]
 [ 2, 32]
```

Find the greatest common divisors for the elements of matrix A and the value 200. Here, gcd expands 200 into the 2-by-2 matrix with all elements equal to 200.

```
gcd(A,200)
```

```
ans =
 [ 1,  2]
 [ 2,  8]
```

GCD Is Positive Linear Combination of Inputs

A theorem in number theory states that the GCD of two numbers is the smallest positive linear combination of those numbers. Show that the GCD is a positive linear combination for 64 and 44.

```
A = sym([64 44]);
[G,M] = gcd(A)
```

```
G =
 4
M =
 [-2, 3]
```

```
isequal(G,sum(M.*A))
```

```
ans =
 logical
 1
```

Bézout Coefficients

Find the greatest common divisor and the Bézout coefficients of these polynomials. For multivariate expressions, use the third input argument to specify the polynomial variable. When computing Bézout coefficients, gcd ensures that the polynomial variable does not appear in their denominators.

Find the greatest common divisor and the Bézout coefficients of these polynomials with respect to variable x.

```
[G,C,D] = gcd(x^2*y + x^3, (x + y)^2, x)
```

```
G =
 x + y
```

```
C =
 1/y^2
```

```
D =
 1/y - x/y^2
```

Find the greatest common divisor and the Bézout coefficients of the same polynomials with respect to variable y.

```
[G,C,D] = gcd(x^2*y + x^3, (x + y)^2, y)
```

```
G =
x + y
```

```
C =
1/x^2
```

```
D =
0
```

If you do not specify the polynomial variable, then the toolbox uses `symvar` to determine the variable.

```
[G,C,D] = gcd(x^2*y + x^3, (x + y)^2)
```

```
G =
x + y
```

```
C =
1/y^2
```

```
D =
1/y - x/y^2
```

Solution to Diophantine Equation

Solve the Diophantine equation, $30x + 56y = 8$, for x and y .

Find the greatest common divisor and a pair of Bézout coefficients for 30 and 56.

```
[G,C,D] = gcd(sym(30),56)
```

```
G =
2
```

```
C =
-13
```

```
D =
7
```

$C = -13$ and $D = 7$ satisfy the Bézout's identity, $(30*(-13)) + (56*7) = 2$.

Rewrite Bézout's identity so that it looks more like the original equation. Do this by multiplying by 4. Use `==` to verify that both sides of the equation are equal.

```
isAlways((30*C*4) + (56*D*4) == G*4)
```

```
ans =
    logical
     1
```

Calculate the values of x and y that solve the Diophantine equation.

```
x = C*4
y = D*4
```

```
x =
-52
```

y =
28

Input Arguments

A — Input value

number | symbolic number | symbolic variable | symbolic expression | symbolic function | symbolic vector | symbolic matrix

Input value, specified as a number, symbolic number, variable, expression, function, or a vector or matrix of numbers, symbolic numbers, variables, expressions, or functions.

B — Input value

number | symbolic number | symbolic variable | symbolic expression | symbolic function | symbolic vector | symbolic matrix

Input value, specified as a number, symbolic number, variable, expression, function, or a vector or matrix of numbers, symbolic numbers, variables, expressions, or functions.

X — Polynomial variable

symbolic variable

Polynomial variable, specified as a symbolic variable.

Output Arguments

G — Greatest common divisor

symbolic number | symbolic variable | symbolic expression | symbolic function | symbolic vector | symbolic matrix

Greatest common divisor, returned as a symbolic number, variable, expression, function, or a vector or matrix of symbolic numbers, variables, expressions, or functions.

M — Linear combination of input

symbolic vector | symbolic matrix | symbolic array

Linear combination of input that equals GCD of input, returned as a symbolic vector, matrix, or array.

C, D — Bézout coefficients

symbolic number | symbolic variable | symbolic expression | symbolic function | symbolic vector | symbolic matrix

Bézout coefficients, returned as symbolic numbers, variables, expressions, functions, or vectors or matrices of symbolic numbers, variables, expressions, or functions.

Tips

- Calling `gcd` for numbers that are not symbolic objects invokes the MATLAB `gcd` function.
- The MATLAB `gcd` function does not accept rational or complex arguments. To find the greatest common divisor of rational or complex numbers, convert these numbers to symbolic objects by using `sym`, and then use `gcd`.

- Nonscalar arguments must be the same size. If one input argument is nonscalar, then `gcd` expands the scalar into a vector or matrix of the same size as the nonscalar argument, with all elements equal to the corresponding scalar.

See Also

`lcm`

Introduced in R2014b

ge

Define greater than or equal to condition

Syntax

```
A >= B
ge(A,B)
```

Description

A >= B creates the condition greater than or equal.

ge(A,B) is equivalent to A >= B.

Examples

Set and Use Assumption Using Greater Than Equal To

Set the assumption that x is greater than or equal to 3 by using `assume`.

```
syms x
assume(x >= 3)
```

Solve this equation involving x. The solver only returns solutions that are valid under the assumption on x.

```
eqn = (x-1)*(x-2)*(x-3)*(x-4) == 0;
solve(eqn,x)
```

```
ans =
     3
     4
```

Find Values that Satisfy Condition

Set the condition `abs(sin(x)) >= 1/2`.

```
syms x
cond = abs(sin(x)) >= 1/2;
```

Find multiples of $\pi/24$ that satisfy the condition by using a `for` loop from 0 to π .

```
for i = 0:sym(pi/12):sym(pi)
    if subs(cond,x,i)
        disp(i)
    end
end
```

```
pi/6
pi/4
pi/3
(5*pi)/12
```

```
pi/2  
(7*pi)/12  
(2*pi)/3  
(3*pi)/4  
(5*pi)/6
```

Input Arguments

A — Input

number | vector | matrix | array | symbolic number | symbolic variable | symbolic array | symbolic function | symbolic expression

Input, specified as a number, vector, matrix, or array, or a symbolic number, variable, array, function, or expression.

B — Input

number | vector | matrix | array | symbolic number | symbolic variable | symbolic array | symbolic function | symbolic expression

Input, specified as a number, vector, matrix, or array, or a symbolic number, variable, array, function, or expression.

Tips

- Calling `>=` or `ge` for non-symbolic `A` and `B` invokes the MATLAB `ge` function. This function returns a logical array with elements set to logical `1` (`true`) where `A` is greater than or equal to `B`; otherwise, it returns logical `0` (`false`).
- If both `A` and `B` are arrays, then these arrays must have the same dimensions. `A >= B` returns an array of relations `A(i,j,...) >= B(i,j,...)`
- If one input is scalar and the other an array, then the scalar input is expanded into an array of the same dimensions as the other array.
- The field of complex numbers is not an ordered field. MATLAB projects complex numbers in relations to a real axis. For example, `x >= i` becomes `x >= 0`, and `x >= 3+2*i` becomes `x >= 3`.

See Also

`eq` | `gt` | `isAlways` | `le` | `lt` | `ne`

Topics

“Set Assumptions” on page 1-24

Introduced in R2012a

gegenbauerC

Gegenbauer polynomials

Syntax

`gegenbauerC(n, a, x)`

Description

`gegenbauerC(n, a, x)` represents the n th-degree Gegenbauer (ultraspherical) polynomial on page 4-668 with parameter a at the point x .

Examples

First Four Gegenbauer Polynomials

Find the first four Gegenbauer polynomials for the parameter a and variable x .

```
syms a x
gegenbauerC([0, 1, 2, 3], a, x)

ans =
[ 1, 2*a*x, (2*a^2 + 2*a)*x^2 - a, ...
((4*a^3)/3 + 4*a^2 + (8*a)/3)*x^3 + (- 2*a^2 - 2*a)*x]
```

Gegenbauer Polynomials for Numeric and Symbolic Arguments

Depending on its arguments, `gegenbauerC` returns floating-point or exact symbolic results.

Find the value of the fifth-degree Gegenbauer polynomial for the parameter $a = 1/3$ at these points. Because these numbers are not symbolic objects, `gegenbauerC` returns floating-point results.

```
gegenbauerC(5, 1/3, [1/6, 1/4, 1/3, 1/2, 2/3, 3/4])

ans =
    0.1520    0.1911    0.1914    0.0672   -0.1483   -0.2188
```

Find the value of the fifth-degree Gegenbauer polynomial for the same numbers converted to symbolic objects. For symbolic numbers, `gegenbauerC` returns exact symbolic results.

```
gegenbauerC(5, 1/3, sym([1/6, 1/4, 1/3, 1/2, 2/3, 3/4]))

ans =
[ 26929/177147, 4459/23328, 33908/177147, 49/729, -26264/177147, -7/32]
```

Evaluate Chebyshev Polynomials with Floating-Point Numbers

Floating-point evaluation of Gegenbauer polynomials by direct calls of `gegenbauerC` is numerically stable. However, first computing the polynomial using a symbolic variable, and then substituting variable-precision values into this expression can be numerically unstable.

Find the value of the 500th-degree Gegenbauer polynomial for the parameter 4 at $1/3$ and `vpa(1/3)`. Floating-point evaluation is numerically stable.

```
gegenbauerC(500, 4, 1/3)
gegenbauerC(500, 4, vpa(1/3))
```

```
ans =
  -1.9161e+05
```

```
ans =
-191609.10250897532784888518393655
```

Now, find the symbolic polynomial $C500 = \text{gegenbauerC}(500, 4, x)$, and substitute $x = \text{vpa}(1/3)$ into the result. This approach is numerically unstable.

```
syms x
C500 = gegenbauerC(500, 4, x);
subs(C500, x, vpa(1/3))
```

```
ans =
-8.0178726380235741521208852037291e+35
```

Approximate the polynomial coefficients by using `vpa`, and then substitute $x = \text{sym}(1/3)$ into the result. This approach is also numerically unstable.

```
subs(vpa(C500), x, sym(1/3))
```

```
ans =
-8.1125412405858470246887213923167e+36
```

Plot Gegenbauer Polynomials

Plot the first five Gegenbauer polynomials for the parameter $a = 3$.

```
syms x y
fplot(gegenbauerC(0:4,3,x))
axis([-1 1 -10 10])
grid on

ylabel('G_n^3(x)')
title('Gegenbauer polynomials')
legend('G_0^3(x)', 'G_1^3(x)', 'G_2^3(x)', 'G_3^3(x)', 'G_4^3(x)', ...
       'Location', 'Best')
```

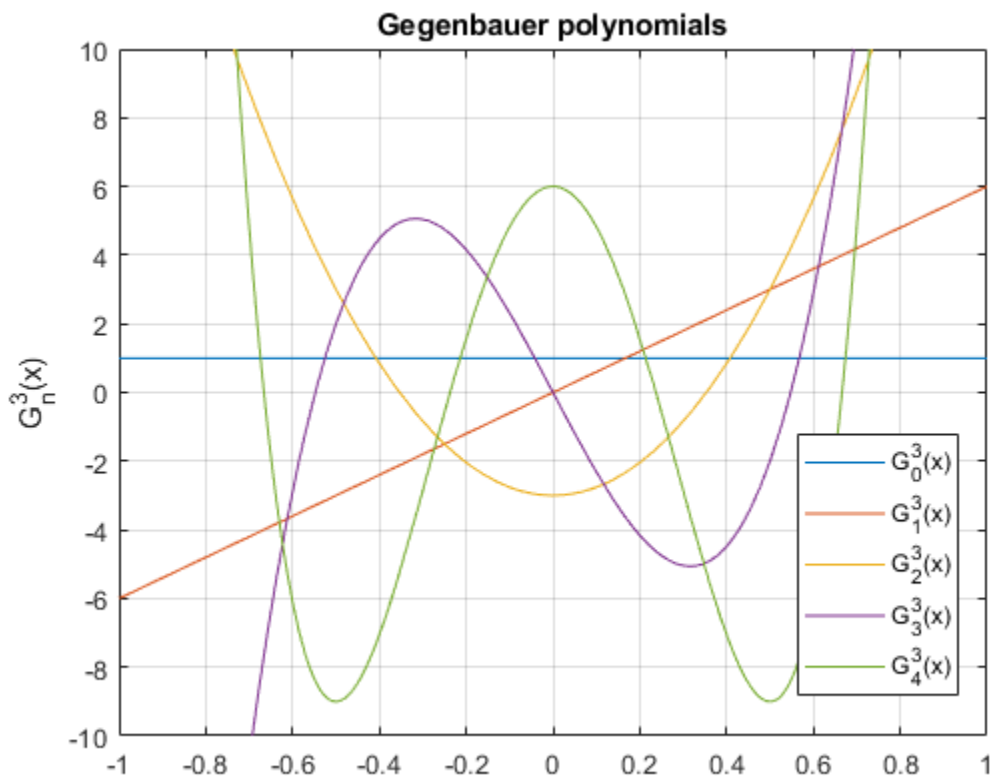
Input Arguments

n – Degree of polynomial

nonnegative integer | symbolic variable | symbolic expression | symbolic function | vector | matrix

Degree of the polynomial, specified as a nonnegative integer, symbolic variable, expression, or function, or as a vector or matrix of numbers, symbolic numbers, variables, expressions, or functions.

a – Parameter

number | symbolic number | symbolic variable | symbolic expression | symbolic function | vector | matrix

Parameter, specified as a nonnegative integer, symbolic variable, expression, or function, or as a vector or matrix of numbers, symbolic numbers, variables, expressions, or functions.

x – Evaluation point

number | symbolic number | symbolic variable | symbolic expression | symbolic function | vector | matrix

Evaluation point, specified as a number, symbolic number, variable, expression, or function, or as a vector or matrix of numbers, symbolic numbers, variables, expressions, or functions.

More About

Gegenbauer Polynomials

- Gegenbauer polynomials are defined by this recursion formula.

$$G(0, a, x) = 1, \quad G(1, a, x) = 2ax, \quad G(n, a, x) = \frac{2x(n+a-1)}{n}G(n-1, a, x) - \frac{n+2a-2}{n}G(n-2, a, x)$$

- For all real $a > -1/2$, Gegenbauer polynomials are orthogonal on the interval $-1 \leq x \leq 1$ with respect to the weight function $w(x) = (1-x^2)^{a-\frac{1}{2}}$.

$$\int_{-1}^1 G(n, a, x)G(m, a, x)(1-x^2)^{a-\frac{1}{2}} dx = \begin{cases} 0 & \text{if } n \neq m \\ \frac{\pi 2^{1-2a} \Gamma(n+2a)}{n!(n+a)(\Gamma(a))^2} & \text{if } n = m. \end{cases}$$

- Chebyshev polynomials of the first and second kinds are a special case of the Gegenbauer polynomials.

$$T(n, x) = \frac{n}{2}G(n, 0, x)$$

$$U(n, x) = G(n, 1, x)$$

- Legendre polynomials are also a special case of the Gegenbauer polynomials.

$$P(n, x) = G\left(n, \frac{1}{2}, x\right)$$

Tips

- `gegenbauerC` returns floating-point results for numeric arguments that are not symbolic objects.
- `gegenbauerC` acts element-wise on nonscalar inputs.
- All nonscalar arguments must have the same size. If one or two input arguments are nonscalar, then `gegenbauerC` expands the scalars into vectors or matrices of the same size as the nonscalar arguments, with all elements equal to the corresponding scalar.

References

- [1] Hochstrasser, U. W. "Orthogonal Polynomials." *Handbook of Mathematical Functions with Formulas, Graphs, and Mathematical Tables*. (M. Abramowitz and I. A. Stegun, eds.). New York: Dover, 1972.

See Also

`chebyshevT` | `chebyshevU` | `hermiteH` | `jacobiP` | `laguerreL` | `legendreP`

Introduced in R2014b

gradient

Gradient vector of scalar function

Syntax

`gradient(f,v)`

Description

`gradient(f,v)` finds the gradient vector of the scalar function f with respect to vector v in Cartesian coordinates.

If you do not specify v , then `gradient(f)` finds the gradient vector of the scalar function f with respect to a vector constructed from all symbolic variables found in f . The order of variables in this vector is defined by `symvar`.

Examples

Find Gradient of Function

The gradient of a function f with respect to the vector v is the vector of the first partial derivatives of f with respect to each element of v .

Find the gradient vector of $f(x, y, z)$ with respect to vector $[x, y, z]$. The gradient is a vector with these components.

```
syms x y z
f = 2*y*z*sin(x) + 3*x*sin(z)*cos(y);
gradient(f, [x, y, z])
```

```
ans =
 3*cos(y)*sin(z) + 2*y*z*cos(x)
 2*z*sin(x) - 3*x*sin(y)*sin(z)
 2*y*sin(x) + 3*x*cos(y)*cos(z)
```

Plot Gradient of Function

Find the gradient of a function $f(x, y)$, and plot it as a quiver (velocity) plot.

Find the gradient vector of $f(x, y)$ with respect to vector $[x, y]$. The gradient is vector g with these components.

```
syms x y
f = -(sin(x) + sin(y))^2;
g = gradient(f, [x, y])

g =
-2*cos(x)*(sin(x) + sin(y))
-2*cos(y)*(sin(x) + sin(y))
```

Now plot the vector field defined by these components. MATLAB provides the `quiver` plotting function for this task. The function does not accept symbolic arguments. First, replace symbolic variables in expressions for components of `g` with numeric values. Then use `quiver`:

```
[X, Y] = meshgrid(-1:.1:1,-1:.1:1);
G1 = subs(g(1), [x y], {X,Y});
G2 = subs(g(2), [x y], {X,Y});
quiver(X, Y, G1, G2)
```

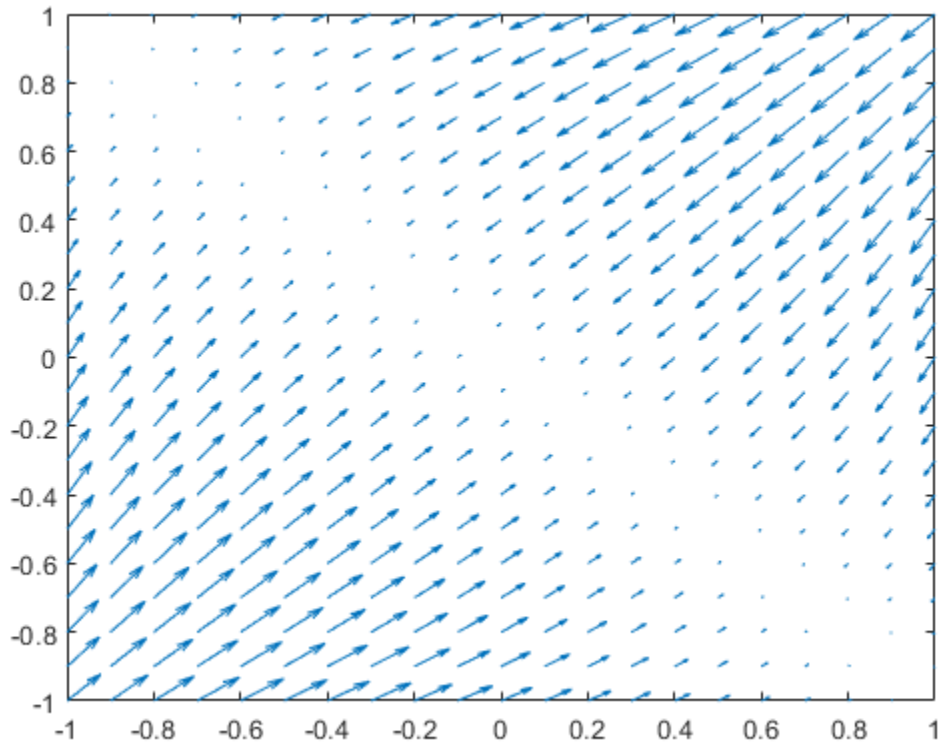

Input Arguments

f – Scalar function

symbolic expression | symbolic function

Scalar function, specified as symbolic expression or symbolic function.

v – Vector with respect to which you find gradient vector

symbolic vector

Vector with respect to which you find gradient vector, specified as a symbolic vector. By default, `v` is a vector constructed from all symbolic variables found in `f`. The order of variables in this vector is defined by `symvar`.

If `v` is a scalar, `gradient(f,v) = diff(f,v)`. If `v` is an empty symbolic object, such as `sym([])`, then `gradient` returns an empty symbolic object.

More About

Gradient Vector

The gradient vector of $f(x)$ with respect to the vector x is the vector of the first partial derivatives of f .

$$\nabla f = \left(\frac{\partial f}{\partial x_1}, \frac{\partial f}{\partial x_2}, \dots, \frac{\partial f}{\partial x_n} \right)$$

See Also

[curl](#) | [diff](#) | [divergence](#) | [hessian](#) | [jacobian](#) | [laplacian](#) | [potential](#) | [quiver](#) | [vectorPotential](#)

Introduced in R2011b

gbasis

Reduced Groebner basis

Syntax

```
gbasis(poly)
gbasis(poly,vars)
gbasis( ____, 'MonomialOrder', MonomialOrder)
```

Description

`gbasis(poly)` returns the Groebner basis of the vector of polynomials `poly`. By default, `gbasis` finds independent variables in `poly` by using `symvar`, and uses the monomial ordering `degreeInverseLexicographic`.

`gbasis(poly,vars)` also uses the independent variables `vars`.

`gbasis(____, 'MonomialOrder', MonomialOrder)` also uses the specified monomial order in addition to the input arguments in previous syntaxes. Options are `'degreeInverseLexicographic'`, `'degreeLexicographic'`, or `'lexicographic'`. By default, `gbasis` uses `'degreeInverseLexicographic'`.

Examples

Groebner Basis of Polynomials

Calculate the Groebner basis of the polynomials $x^2 - y^2$ and $x^2 + y$. By default, `gbasis` finds the independent variables by using `symvar`.

```
syms x y
p = [x^2-y^2, x^2+y];
gbasis(p)
```

```
ans =
 [ x^2 + y, y^2 + y]
```

Specify Independent Variables

Specify the independent variables as the second argument of `gbasis`.

Compute the Groebner basis of the polynomials $a*y + x^2*y + a$ and $a*x^2 + y$ with the independent variables `[x y]`.

```
syms x y a
p = [a*y + x^2*y + a, a*x^2 + y];
vars = [x y];
grobnerBasis = gbasis(p,vars)
```

```
grobnerBasis =
[ a*x^2 + y, - y^2/a + a*y + a]
```

Groebner Basis with Monomial Order

By default, `gbasis` uses the monomial order `degreeInverseLexicographic`. Change the monomial order by using the `'MonomialOrder'` name-value pair argument.

Find the Groebner basis of the polynomials $y*z^2+1$ and $y^2*x^2-y-z^3$ with lexicographic monomial order.

```
syms x y z
p = [y*z^2 + 1, y^2*x^2 - y - z^3];
grobnerBasis = gbasis(p, 'MonomialOrder', 'lexicographic')
```

```
grobnerBasis =
[ x^2 - z^7 + z^2, y*z^2 + 1]
```

Use the variables `[z y]` with `degreeLexicographic` monomial order.

```
grobnerBasis = gbasis(p, [z y], 'MonomialOrder', 'degreeLexicographic')
```

```
grobnerBasis =
[ x^2*y^2 - y - z^3, y*z^2 + 1, x^2*y^3 - y^2 + z]
```

Input Arguments

poly — Polynomials

vector of symbolic expressions

Polynomials, specified as a vector of symbolic expressions.

vars — Independent variables

vector of symbolic variables

Independent variables, specified as a vector of symbolic variables.

MonomialOrder — Monomial order

`'degreeInverseLexicographic'` (default) | `'degreeLexicographic'` | `'lexicographic'`

Monomial order, specified as the comma-separated pair of `'MonomialOrder'` and one of the values `'degreeInverseLexicographic'`, `'degreeLexicographic'`, or `'lexicographic'`. If `vars` is specified, then monomials are sorted with respect to the order of variables in `vars`.

- `lexicographic` sorts the terms of the polynomial using lexicographic ordering.
- `degreeLexicographic` sorts the terms of a polynomial according to the total degree of each term. If terms have equal total degrees, `polynomialReduce` sorts them using lexicographic ordering.
- `degreeInverseLexicographic` sorts the terms of a polynomial according to the total degree of each term. If terms have equal total degrees, `polynomialReduce` sorts them using inverse lexicographic ordering.

See Also

eliminate | solve

Topics

“Solve Algebraic Equation” on page 2-153

“Solve System of Linear Equations” on page 2-173

Introduced in R2018a

gt

Define greater than relation

Syntax

```
A > B
gt(A,B)
```

Description

$A > B$ creates a greater than relation.

`gt(A,B)` is equivalent to $A > B$.

Examples

Set and Use Assumption Using Greater Than

Use `assume` and the relational operator `>` to set the assumption that x is greater than 3:

```
syms x
assume(x > 3)
```

Solve this equation. The solver takes into account the assumption on variable x , and therefore returns this solution.

```
solve((x - 1)*(x - 2)*(x - 3)*(x - 4) == 0, x)
```

```
ans =
4
```

Find Values that Satisfy Condition

Use the relational operator `>` to set this condition on variable x :

```
syms x
cond = abs(sin(x)) + abs(cos(x)) > 7/5;

for i = 0:sym(pi/24):sym(pi)
    if subs(cond, x, i)
        disp(i)
    end
end
```

Use the `for` loop with step $\pi/24$ to find angles from 0 to π that satisfy that condition:

```
(5*pi)/24
pi/4
(7*pi)/24
(17*pi)/24
(3*pi)/4
(19*pi)/24
```

Input Arguments

A — Input

number | vector | matrix | array | symbolic number | symbolic variable | symbolic array | symbolic function | symbolic expression

Input, specified as a number, vector, matrix, or array, or a symbolic number, variable, array, function, or expression.

B — Input

number | vector | matrix | array | symbolic number | symbolic variable | symbolic array | symbolic function | symbolic expression

Input, specified as a number, vector, matrix, or array, or a symbolic number, variable, array, function, or expression.

Tips

- Calling `>` or `gt` for non-symbolic `A` and `B` invokes the MATLAB `gt` function. This function returns a logical array with elements set to logical 1 (`true`) where `A` is greater than `B`; otherwise, it returns logical 0 (`false`).
- If both `A` and `B` are arrays, then these arrays must have the same dimensions. `A > B` returns an array of relations `A(i,j,...) > B(i,j,...)`
- If one input is scalar and the other an array, then the scalar input is expanded into an array of the same dimensions as the other array. In other words, if `A` is a variable (for example, `x`), and `B` is an m -by- n matrix, then `A` is expanded into m -by- n matrix of elements, each set to `x`.
- The field of complex numbers is not an ordered field. MATLAB projects complex numbers in relations to a real axis. For example, `x > i` becomes `x > 0`, and `x > 3 + 2*i` becomes `x > 3`.

See Also

`eq` | `ge` | `isAlways` | `le` | `lt` | `ne`

Topics

“Set Assumptions” on page 1-24

Introduced in R2012a

harmonic

Harmonic function (harmonic number)

Syntax

`harmonic(x)`

Description

`harmonic(x)` returns the harmonic function on page 4-680 of `x`. For integer values of `x`, `harmonic(x)` generates harmonic numbers.

Examples

Generate Harmonic Numbers

Generate the first 10 harmonic numbers.

```
harmonic(sym(1:10))

ans =
[ 1, 3/2, 11/6, 25/12, 137/60, 49/20, 363/140, 761/280, 7129/2520, 7381/2520]
```

Harmonic Function for Numeric and Symbolic Arguments

Find the harmonic function for these numbers. Since these are not symbolic objects, you get floating-point results.

```
harmonic([2 i 13/3])

ans =
    1.5000 + 0.0000i    0.6719 + 1.0767i    2.1545 + 0.0000i
```

Find the harmonic function symbolically by converting the numbers to symbolic objects.

```
y = harmonic(sym([2 i 13/3]))

y =
[ 3/2, harmonic(1i), 8571/1820 - (pi*3^(1/2))/6 - (3*log(3))/2]
```

If the denominator of `x` is 2, 3, 4, or 6, and $|x| < 500$, then the result is expressed in terms of `pi` and `log`.

Use `vpa` to approximate the results obtained.

```
vpa(y)

ans =
[ 1.5, 0.67186598552400983787839057280431...
+ 1.07667404746858117413405079475i,...
2.1545225442213858782694336751358]
```

For $|x| > 1000$, `harmonic` returns the function call as it is. Use `vpa` to force `harmonic` to evaluate the function call.

```
harmonic(sym(1001))
vpa(harmonic(sym(1001)))

ans =
harmonic(1001)
ans =
7.4864698615493459116575172053329
```

Harmonic Function for Special Values

Find the harmonic function for special values.

```
harmonic([0 1 -1 Inf -Inf])

ans =
     0     1   Inf   Inf   NaN
```

Harmonic Function for Symbolic Functions

Find the harmonic function for the symbolic function f .

```
syms f(x)
f(x) = exp(x) + tan(x);
y = harmonic(f)

y(x) =
harmonic(exp(x) + tan(x))
```

Harmonic Function for Symbolic Vectors and Matrices

Find the harmonic function for elements of vector V and matrix M .

```
syms x
V = [x sin(x) 3*i];
M = [exp(i*x) 2; -6 Inf];
harmonic(V)
harmonic(M)

ans =
[ harmonic(x), harmonic(sin(x)), harmonic(3i)]
ans =
[ harmonic(exp(x*1i)), 3/2]
[          Inf, Inf]
```

Plot Harmonic Function

Plot the harmonic function from $x = -5$ to $x = 5$.

```
syms x
fplot(harmonic(x),[-5 5])
grid on
```

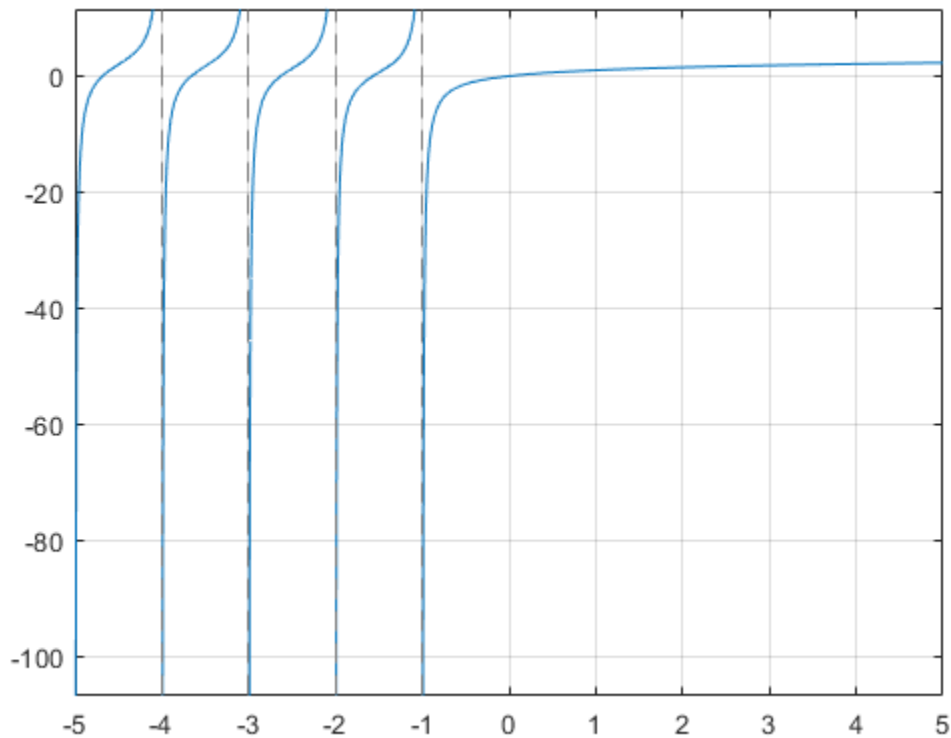

Differentiate and Find Limit of Harmonic Function

The functions `diff` and `limit` handle expressions containing harmonic.

Find the second derivative of $\text{harmonic}(x^2+1)$.

```
syms x
diff(harmonic(x^2+1),x,2)

ans =
2*psi(1, x^2 + 2) + 4*x^2*psi(2, x^2 + 2)
```

Find the limit of $\text{harmonic}(x)$ as x tends to ∞ and of $(x+1)*\text{harmonic}(x)$ as x tends to -1 .

```
syms x
limit(harmonic(x),Inf)
limit((x+1)*harmonic(x),-1)

ans =
Inf
ans =
-1
```

Taylor Series Expansion of Harmonic Function

Use `taylor` to expand the harmonic function in terms of the Taylor series.

```
syms x
taylor(harmonic(x))

ans =
(pi^6*x^5)/945 - zeta(5)*x^4 + (pi^4*x^3)/90...
- zeta(3)*x^2 + (pi^2*x)/6
```

Expand Harmonic Function

Use `expand` to expand the harmonic function.

```
syms x
expand(harmonic(2*x+3))

ans =
harmonic(x + 1/2)/2 + log(2) + harmonic(x)/2 - 1/(2*(x + 1/2))...
+ 1/(2*x + 1) + 1/(2*x + 2) + 1/(2*x + 3)
```

Input Arguments

x — Input

number | vector | matrix | multidimensional array | symbolic variable | symbolic expression | symbolic function | symbolic vector | symbolic matrix | symbolic N-D array

Input, specified as number, vector, matrix, or as a multidimensional array or symbolic variable, expression, function, vector, matrix, or multidimensional array.

More About

Harmonic Function

The harmonic function for x is defined as

$$\text{harmonic}(x) = \sum_{k=1}^x \frac{1}{k}$$

It is also defined as

$$\text{harmonic}(x) = \Psi(x + 1) + \gamma$$

where $\Psi(x)$ is the polygamma function and γ is the Euler-Mascheroni constant.

Algorithms

The harmonic function is defined for all complex arguments z except for negative integers $-1, -2, \dots$ where a singularity occurs.

If x has denominator 1, 2, 3, 4, or 6, then an explicit result is computed and returned. For other rational numbers, `harmonic` uses the functional equation $\text{harmonic}(x + 1) = \text{harmonic}(x) + \frac{1}{x}$ to obtain a result with an argument x from the interval $[0, 1]$.

expand expands harmonic using the equations $\text{harmonic}(x + 1) = \text{harmonic}(x) + \frac{1}{x}$, $\text{harmonic}(-x) = \text{harmonic}(x) - \frac{1}{x} + \pi \cot(\pi x)$, and the Gauss multiplication formula for $\text{harmonic}(kx)$, where k is an integer.

harmonic implements the following explicit formulae:

$$\text{harmonic}\left(\frac{-1}{2}\right) = -2\ln(2)$$

$$\text{harmonic}\left(-\frac{2}{3}\right) = -\frac{3}{2}\ln(3) - \frac{\sqrt{3}}{6}\pi$$

$$\text{harmonic}\left(-\frac{1}{3}\right) = -\frac{3}{2}\ln(3) + \frac{\sqrt{3}}{6}\pi$$

$$\text{harmonic}\left(\frac{-3}{4}\right) = -3\ln(2) - \frac{\pi}{2}$$

$$\text{harmonic}\left(\frac{-1}{4}\right) = -3\ln(2) + \frac{\pi}{2}$$

$$\text{harmonic}\left(\frac{-5}{6}\right) = -2\ln(2) - \frac{3}{2}\ln(3) - \frac{\sqrt{3}}{2}\pi$$

$$\text{harmonic}\left(\frac{-1}{6}\right) = -2\ln(2) - \frac{3}{2}\ln(3) + \frac{\sqrt{3}}{2}\pi$$

$$\text{harmonic}(0) = 0$$

$$\text{harmonic}\left(\frac{1}{2}\right) = 2 - 2\ln(2)$$

$$\text{harmonic}\left(\frac{1}{3}\right) = 3 - \frac{3}{2}\ln(3) - \frac{\sqrt{3}}{6}\pi$$

$$\text{harmonic}\left(\frac{2}{3}\right) = \frac{3}{2} - \frac{3}{2}\ln(3) + \frac{\sqrt{3}}{6}\pi$$

$$\text{harmonic}\left(\frac{1}{4}\right) = 4 - 3\ln(2) - \frac{\pi}{2}$$

$$\text{harmonic}\left(\frac{3}{4}\right) = \frac{4}{3} - 3\ln(2) + \frac{\pi}{2}$$

$$\text{harmonic}\left(\frac{1}{6}\right) = 6 - 2\ln(2) - \frac{3}{2}\ln(3) - \frac{\sqrt{3}}{2}\pi$$

$$\text{harmonic}\left(\frac{5}{6}\right) = \frac{6}{5} - 2\ln(2) - \frac{3}{2}\ln(3) + \frac{\sqrt{3}}{2}\pi$$

$$\text{harmonic}(1) = 1$$

$$\text{harmonic}(\infty) = \infty$$

$$\text{harmonic}(-\infty) = \text{NaN}$$

See Also

beta | factorial | gamma | gammaLn | nchoosek | zeta

Introduced in R2014a

has

Check if expression contains particular subexpression

Syntax

`has(expr, subexpr)`

Description

`has(expr, subexpr)` returns logical 1 (true) if `expr` contains `subexpr`. Otherwise, it returns logical 0 (false).

- If `expr` is an array, `has(expr, subexpr)` returns an array of the same size as `expr`. The returned array contains logical 1s (true) where the elements of `expr` contain `subexpr`, and logical 0s (false) where they do not.
- If `subexpr` is an array, `has(expr, subexpr)` checks if `expr` contains any element of `subexpr`.

Examples

Check If Expression Contains Particular Subexpression

Use the `has` function to check if an expression contains a particular variable or subexpression.

Check if these expressions contain variable `z`.

```
syms x y z
has(x + y + z, z)
```

```
ans =
    logical
     1
```

```
has(x + y, z)
```

```
ans =
    logical
     0
```

Check if `x + y + z` contains the following subexpressions. Note that `has` finds the subexpression `x + z` even though the terms `x` and `z` do not appear next to each other in the expression.

```
has(x + y + z, x + y)
has(x + y + z, y + z)
has(x + y + z, x + z)
```

```
ans =
    logical
     1
ans =
    logical
     1
ans =
```

```
logical
1
```

Check if the expression $(x + 1)^2$ contains x^2 . Although $(x + 1)^2$ is mathematically equivalent to the expression $x^2 + 2*x + 1$, the result is a logical 0 because `has` typically does not transform expressions to different forms when testing for subexpressions.

```
has((x + 1)^2, x^2)
```

```
ans =
logical
0
```

Expand the expression and then call `has` to check if the result contains x^2 . Because `expand((x + 1)^2)` transforms the original expression to $x^2 + 2*x + 1$, the `has` function finds the subexpression x^2 and returns logical 1.

```
has(expand((x + 1)^2), x^2)
```

```
ans =
logical
1
```

Check If Expression Contains Any of Specified Subexpressions

Check if a symbolic expression contains any of subexpressions specified as elements of a vector.

If an expression contains one or more of the specified subexpressions, `has` returns logical 1.

```
syms x
has(sin(x) + cos(x) + x^2, [tan(x), cot(x), sin(x), exp(x)])
```

```
ans =
logical
1
```

If an expression does not contain any of the specified subexpressions, `has` returns logical 0.

```
syms x
has(sin(x) + cos(x) + x^2, [tan(x), cot(x), exp(x)])
```

```
ans =
logical
0
```

Find Matrix Elements Containing Particular Subexpression

Using `has`, find those elements of a symbolic matrix that contain a particular subexpression.

First, create a matrix.

```
syms x y
M = [sin(x)*sin(y), cos(x*y) + 1; cos(x)*tan(x), 2*sin(x)^2]
```

```
M =
[ sin(x)*sin(y), cos(x*y) + 1]
[ cos(x)*tan(x), 2*sin(x)^2]
```

Use `has` to check which elements of `M` contain `sin(x)`. The result is a matrix of the same size as `M`, with `1s` and `0s` as its elements. For the elements of `M` containing the specified expression, `has` returns logical `1s`. For the elements that do not contain that subexpression, `has` returns logical `0s`.

```
T = has(M, sin(x))
```

```
T =
  2x2 logical array
     1     0
     0     1
```

Return only the elements that contain `sin(x)` and replace all other elements with `0` by multiplying `M` by `T` elementwise.

```
M.*T
```

```
ans =
 [ sin(x)*sin(y),          0]
 [          0, 2*sin(x)^2]
```

To check if any of matrix elements contain a particular subexpression, use `any`.

```
any(has(M(:), sin(x)))
```

```
ans =
 logical
     1
```

```
any(has(M(:), cos(y)))
```

```
ans =
 logical
     0
```

Find Vector Elements Containing Any of Specified Subexpressions

Using `has`, find those elements of a symbolic vector that contain any of the specified subexpressions.

```
syms x y z
T = has([x + 1, cos(y) + 1, y + z, 2*x*cos(y)], [x, cos(y)])
```

```
T =
  1x4 logical array
     1     1     0     1
```

Return only the elements of the original vector that contain `x` or `cos(y)` or both, and replace all other elements with `0` by multiplying the original vector by `T` elementwise.

```
[x + 1, cos(y) + 1, y + z, 2*x*cos(y)].*T
```

```
ans =
 [ x + 1, cos(y) + 1, 0, 2*x*cos(y)]
```

Use has for Symbolic Functions

If `expr` or `subexpr` is a symbolic function, `has` uses `formula(expr)` or `formula(subexpr)`. This approach lets the `has` function check if an expression defining the symbolic function `expr` contains an expression defining the symbolic function `subexpr`.

Create a symbolic function.

```
syms x
f(x) = sin(x) + cos(x);
```

Here, $\sin(x) + \cos(x)$ is an expression defining the symbolic function f .

```
formula(f)
```

```
ans =
cos(x) + sin(x)
```

Check if f and $f(x)$ contain $\sin(x)$. In both cases `has` checks if the expression $\sin(x) + \cos(x)$ contains $\sin(x)$.

```
has(f, sin(x))
has(f(x), sin(x))
```

```
ans =
    logical
     1
ans =
    logical
     1
```

Check if $f(x^2)$ contains f . For these arguments, `has` returns logical 0 (false) because it does not check if the expression $f(x^2)$ contains the letter f . This call is equivalent to `has(f(x^2), formula(f))`, which, in turn, resolves to `has(cos(x^2) + sin(x^2), cos(x) + sin(x))`.

```
has(f(x^2), f)
```

```
ans =
    logical
     0
```

Check for Calls to Particular Function

Check for calls to a particular function by specifying the function name as the second argument. Check for calls to any one of multiple functions by specifying the multiple functions as a cell array of character vectors.

Integrate $\tan(x^7)$. Determine if the integration is successful by checking the result for calls to `int`. Because `has` finds the `int` function and returns logical 1 (true), the integration is not successful.

```
syms x
f = int(tan(x^7), x);
has(f, 'int')
```

```
ans =
    logical
     1
```

Check if the solution to a differential equation contains calls to either `sin` or `cos` by specifying the second argument as `{'sin', 'cos'}`. The `has` function returns logical 0 (false), which means the solution does not contain calls to either `sin` or `cos`.

```
syms y(x) a
sol = dsolve(diff(y,x) == a*y);
has(sol, {'sin' 'cos'})
```

```
ans =  
    logical  
     0
```

Input Arguments

expr — Expression to test

symbolic expression | symbolic function | symbolic equation | symbolic inequality | symbolic vector | symbolic matrix | symbolic array

Expression to test, specified as a symbolic expression, function, equation, or inequality. Also it can be a vector, matrix, or array of symbolic expressions, functions, equations, and inequalities.

subexpr — Subexpression to check for

symbolic variable | symbolic expression | symbolic function | symbolic equation | symbolic inequality | symbolic vector | symbolic matrix | symbolic array | character vector | cell array of character vectors

Subexpression to test for, specified as a symbolic variable, expression, function, equation, or inequality, or a character vector, or a cell array of character vectors. `subexpr` can also be a vector, matrix, or array of symbolic variables, expressions, functions, equations, and inequalities.

Tips

- `has` does not transform or simplify expressions. This is why it does not find subexpressions like x^2 in expressions like $(x + 1)^2$. However, in some cases `has` might find that an expression or subexpression can be represented in a form other than its original form. For example, `has` finds that the expression $-x - 1$ can be represented as $-(x + 1)$. Thus, the call `has(-x - 1, x + 1)` returns 1.
- If `expr` is an empty symbolic array, `has` returns an empty logical array of the same size as `expr`.

See Also

`subexpr` | `subs` | `times`

Introduced in R2015b

hasSymType

Determine whether symbolic object contains specific type

Syntax

```
TF = hasSymType(symObj, type)
TF = hasSymType(symObj, funType, vars)
```

Description

`TF = hasSymType(symObj, type)` returns logical 1 (true) if the symbolic object `symObj` contains a subobject of type `type`, and logical 0 (false) otherwise. The input `type` must be a case-sensitive string scalar or character vector, and it can include a logical expression.

`TF = hasSymType(symObj, funType, vars)` checks whether `symObj` contains an unassigned symbolic function that depends on the variables `vars`.

You can set the function type `funType` to `'symfunOf'` or `'symfunDependingOn'`. For example, `syms f(x); hasSymType(f, 'symfunOf', x)` returns logical 1.

Examples

Symbolic Variable, Constant, or Number

Determine whether a symbolic expression contains a symbolic variable, constant, or number of a specific type.

Create a symbolic expression.

```
syms x;
expr = sym('1/2') + 2*pi + x
```

```
expr =
    x + 2π +  $\frac{1}{2}$ 
```

Check whether `expr` contains a symbolic variable of type `'variable'`.

```
TF = hasSymType(expr, 'variable')
```

```
TF = logical
    1
```

Check whether `expr` contains a symbolic constant of type `'constant'`.

```
TF = hasSymType(expr, 'constant')
```

```
TF = logical
    1
```

Check whether `expr` contains a symbolic number of type `'integer'`.

```
TF = hasSymType(expr, 'integer')
```

```
TF = logical
    1
```

Check whether `expr` contains a symbolic number of type `'integer | real'`.

```
TF = hasSymType(expr, 'integer | real')
```

```
TF = logical
    1
```

Check whether `expr` contains a symbolic number of type `'complex'`.

```
TF = hasSymType(expr, 'complex')
```

```
TF = logical
    0
```

Symbolic Function or Operator

Determine whether a symbolic equation contains a symbolic function or operator of a specific type.

Create a symbolic equation.

```
syms f(x) n
eq = f(x^n) + int(f(x),x) + vpa(2.7) == 1i
```

```
eq =
    f(x^n) + ∫ f(x)dx + 2.7 = i
```

Check whether `eq` contains the symbolic function `'f'`.

```
TF = hasSymType(eq, 'f')
```

```
TF = logical
    1
```

Check whether `eq` contains an unassigned symbolic function of type `'symfun'`.

```
TF = hasSymType(eq, 'symfun')
```

```
TF = logical
    1
```

Check whether `eq` contains a symbolic math function of type `'int'`.

```
TF = hasSymType(eq, 'int')
```

```
TF = logical
    1
```

Check whether eq contains an operator of type 'power'.

```
TF = hasSymType(eq, 'power')
```

```
TF = logical
    1
```

Function of Multiple Variables

Create a symbolic function of multiple variables using `syms`.

```
syms f(x,y,z)
g = f + x*y + pi
```

```
g(x, y, z) = pi + x*y + f(x,y,z)
```

Check whether g depends on the exact variable x using 'symfunOf'.

```
TF = hasSymType(g, 'symfunOf', x)
```

```
TF = logical
    0
```

Check whether g depends on the exact sequence of variables [x y z] using 'symfunOf'.

```
TF = hasSymType(g, 'symfunOf', [x y z])
```

```
TF = logical
    1
```

Check whether g has any dependency on the variables [y x] using 'symfunDependingOn'.

```
TF = hasSymType(g, 'symfunDependingOn', [y x])
```

```
TF = logical
    1
```

Input Arguments

symObj — Symbolic objects

symbolic expressions | symbolic functions | symbolic variables | symbolic numbers | symbolic units

Symbolic objects, specified as symbolic expressions, symbolic functions, symbolic variables, symbolic numbers, or symbolic units.

type — Symbolic types

scalar string | character vector

Symbolic types, specified as a case-sensitive scalar string or character vector. The input type can contain a logical expression. The value options follow.

Symbolic Type Category	String Values	Examples Returning Logical 1
numbers	<ul style="list-style-type: none"> 'integer' — integer numbers 'rational' — rational numbers 'vpareal' — variable-precision floating-point real numbers 'complex' — complex numbers 'real' — real numbers, including 'integer', 'rational', and 'vpareal' 'number' — numbers, including 'integer', 'rational', 'vpareal', 'complex', and 'real' 	<ul style="list-style-type: none"> hasSymType(sym(2), 'integer') hasSymType(sym(1/2), 'rational') hasSymType(vpa(0.5), 'vpareal') hasSymType(vpa(1i), 'complex') hasSymType([sym(1/2) vpa(0.5)], 'real') hasSymType([vpa(1i) sym(1/2)], 'number')
constants	'constant' — symbolic constants, including 'number'	hasSymType([vpa(1i) sym(pi)], 'constant')
symbolic math functions	'vpa', 'sin', 'exp', and so on — symbolic math functions in symbolic expressions	hasSymType(vpa(sym(pi)), 'vpa')
unassigned symbolic functions	<ul style="list-style-type: none"> 'F', 'g', and so on — function name of an unassigned symbolic function 'symfun' — unassigned symbolic functions 	<ul style="list-style-type: none"> syms F(x); hasSymType(F(x+2), 'F') syms g(x); hasSymType(g(x), 'symfun')
arithmetic operators	<ul style="list-style-type: none"> 'plus' — addition operator + and subtraction operator - 'times' — multiplication operator * and division operator / 'power' — power or exponentiation operator ^ and square root operator sqrt 	<ul style="list-style-type: none"> syms x y; hasSymType(2*x + y, 'plus') syms x y; hasSymType(x*y, 'times') syms x y; hasSymType(x^(y+2), 'power')
variables	'variable' — symbolic variables	hasSymType(sym('x'), 'variable')
units	'units' — symbolic units	hasSymType(symunit('m'), 'units')
expressions	'expression' — symbolic expressions, including all of the preceding symbolic types	hasSymType(sym('x') + 1, 'expression')

Symbolic Type Category	String Values	Examples Returning Logical 1
logical expressions	<ul style="list-style-type: none"> 'or' — logical OR operator 'and' — logical AND operator & 'not' — logical NOT operator ~ 'xor' — logical exclusive-OR operator xor 'logicalexpression' — logical expressions, including 'or', 'and', 'not', and 'xor' 	<ul style="list-style-type: none"> syms x y; hasSymType(x y, 'or') syms x y; hasSymType(x&y, 'and') syms x; hasSymType(~x, 'not') syms x y; hasSymType(xor(x,y), 'xor') syms x y; hasSymType(~x y, 'logicalexpression')
equations and inequalities	<ul style="list-style-type: none"> 'eq' — equality operator == 'ne' — inequality operator ~= 'lt' — less-than operator < or greater-than operator > 'le' — less-than-or-equal-to operator <= or greater-than-or-equal-to operator >= 'equation' — symbolic equations and inequalities, including 'eq', 'ne', 'lt', and 'le' 	<ul style="list-style-type: none"> syms x; hasSymType(x==2, 'eq') syms x; hasSymType(x~=1, 'ne') syms x; hasSymType(x>0, 'lt') syms x; hasSymType(x<=2, 'le') syms x; hasSymType([x>0 x~=1], 'equation')
unsupported symbolic types	'unsupported' — unsupported symbolic types	

funType — Function type

'symfunOf' | 'symfunDependingOn'

Function type, specified as 'symfunOf' or 'symfunDependingOn'.

- 'symfunOf' checks whether symObj contains an unassigned symbolic function that depends on the exact sequence of variables specified by the array vars. For example, syms f(x,y); hasSymType(f, 'symfunOf', [x y]) returns logical 1.
- 'symfunDependingOn' checks whether symObj contains an unassigned symbolic function that has a dependency on the variables specified by the array vars. For example, syms f(x,y); hasSymType(f, 'symfunDependingOn', [y x]) returns logical 1.

vars — Input variables

symbolic variables | symbolic array

Input variables, specified as symbolic variables or a symbolic array.

Tips

- To check whether a symbolic expression contains a particular subexpression, use the has function.

See Also

findSymType | has | isSymType | mapSymType | sym | symFunType | symType | syms

Introduced in R2019a

heaviside

Heaviside step function

Syntax

```
H = heaviside(x)
```

Description

`H = heaviside(x)` evaluates the Heaviside step function (also known as the unit step function) at x . The Heaviside function is a discontinuous function that returns 0 for $x < 0$, $1/2$ for $x = 0$, and 1 for $x > 0$.

Examples

Evaluate Heaviside Function for Symbolic and Numeric Arguments

The `heaviside` function returns 0, $1/2$, or 1 depending on the argument value. If the argument is a floating-point number (not a symbolic object), then `heaviside` returns floating-point results.

Evaluate the Heaviside step function for a symbolic input `sym(-3)`. The function `heaviside(x)` returns 0 for $x < 0$.

```
H = heaviside(sym(-3))
```

```
H = 0
```

Evaluate the Heaviside step function for a symbolic input `sym(3)`. The function `heaviside(x)` returns 1 for $x > 0$.

```
H = heaviside(sym(3))
```

```
H = 1
```

Evaluate the Heaviside step function for a symbolic input `sym(0)`. The function `heaviside(x)` returns $1/2$ for $x = 0$.

```
H = heaviside(sym(0))
```

```
H =  
    1  
    2
```

For a numeric input $x = 0$, the function `heaviside(x)` returns floating-point results.

```
H = heaviside(0)
```

```
H = 0.5000
```

Use Assumptions on Symbolic Variables

`heaviside` takes into account assumptions on variables.

Create a symbolic variable x and assume that it is less than 0.

```
syms x
assume(x < 0)
```

Evaluate the Heaviside step function for the symbolic input x .

```
H = heaviside(x)
```

```
H = 0
```

For further computations, clear the assumptions on x by recreating it using `syms`.

```
syms x
```

Plot Heaviside Function

Plot the Heaviside step function for x and $x - 1$.

```
syms x
fplot(heaviside(x), [-2, 2])
```

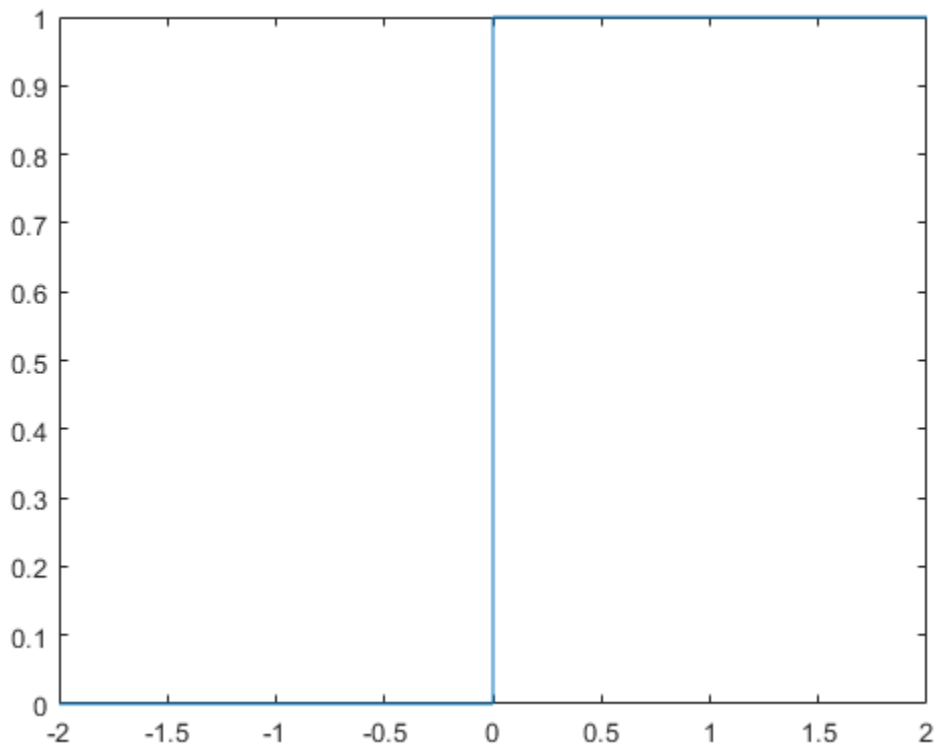

```
fplot(heaviside(x - 1), [-2, 2])
```

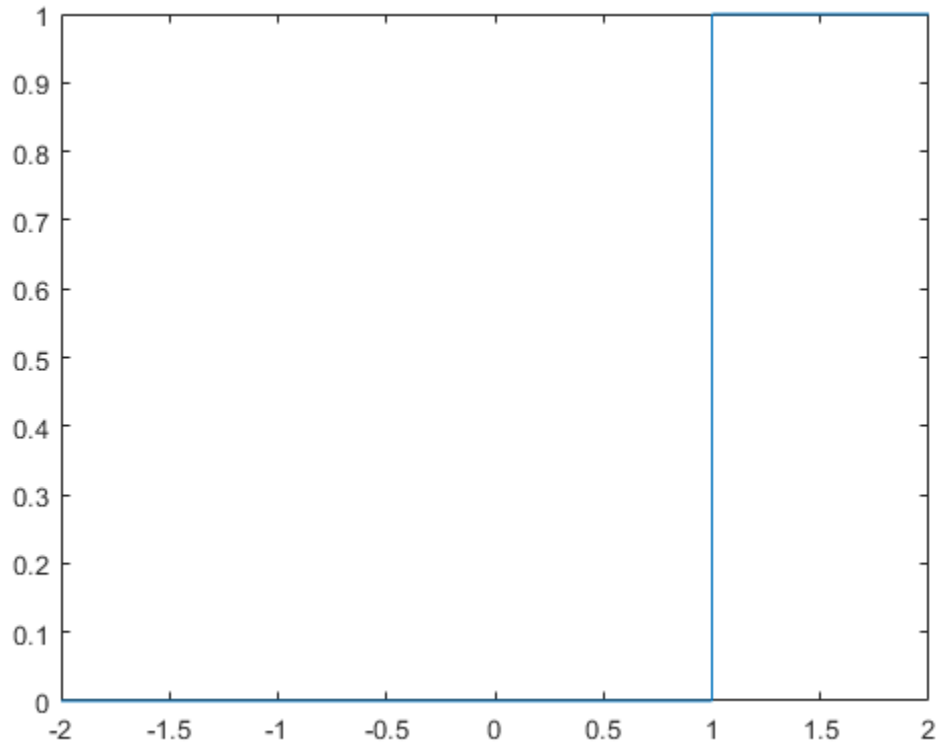

Evaluate Heaviside Function for Symbolic Matrix

Evaluate the Heaviside function for a symbolic matrix. When the input argument is a matrix, `heaviside` computes the Heaviside function for each element.

```
syms x  
H = heaviside(sym([-1 0; 1/2 x]))
```

```
H =  

$$\begin{pmatrix} 0 & \frac{1}{2} \\ 1 & \text{heaviside}(x) \end{pmatrix}$$

```

Differentiate and Integrate Expressions Involving Heaviside Function

Compute derivatives and integrals of expressions involving the Heaviside function.

Find the first derivative of the Heaviside function. The first derivative of the Heaviside function is the Dirac delta function.

```
syms x
diff_H = diff heaviside(x), x)
```

```
diff_H =  $\delta(x)$ 
```

Evaluate the integral $\int_{-\infty}^{\infty} e^{-x} H(x) dx$.

```
syms x
int_H = int(exp(-x)*heaviside(x), x, -Inf, Inf)
```

```
int_H = 1
```

Find Fourier and Laplace Transforms of Heaviside Function

Find the fourier transform of the Heaviside function.

```
syms x
F = fourier(heaviside(x))
```

```
F =
 $\pi \delta(w) - \frac{i}{w}$ 
```

Find the laplace transform of the Heaviside function.

```
syms x
L = laplace(heaviside(x))
```

```
L =
 $\frac{1}{s}$ 
```

Change Value of Heaviside Function at Origin

The default value of the Heaviside function at the origin is 1/2.

```
H = heaviside(sym(0))
```

```
H =
 $\frac{1}{2}$ 
```

Other common values for the Heaviside function at the origin are 0 and 1. To change the value of `heaviside` at the origin, use `sympref` to set the value of the 'HeavisideAtOrigin' preference. Store the previous parameter value returned by `sympref`, so that you can restore it later.

```
oldparam = sympref('HeavisideAtOrigin', 1);
```

Check the new value of `heaviside` at 0.

```
H = heaviside(sym(0))
```

```
H = 1
```

The preferences set by `sympref` persist throughout your current and future MATLAB® sessions. To restore the previous value of `heaviside` at the origin, use the value stored in `oldparam`.

```
sympref('HeavisideAtOrigin',oldparam);
```

Alternatively, you can restore the default value of `'HeavisideAtOrigin'` by using the `'default'` setting.

```
sympref('HeavisideAtOrigin','default');
```

Input Arguments

x — Input

number | symbolic number | symbolic variable | symbolic expression | symbolic function | symbolic vector | symbolic matrix

Input, specified as a number, symbolic number, variable, expression, function, vector, or matrix.

See Also

`dirac` | `laplace` | `sympref`

Introduced before R2006a

hermiteForm

Hermite form of matrix

Syntax

```
H = hermiteForm(A)
[U,H] = hermiteForm(A)
___ = hermiteForm(A,var)
```

Description

`H = hermiteForm(A)` returns the Hermite normal form on page 4-702 of a matrix `A`. The elements of `A` must be integers or polynomials in a variable determined by `symvar(A,1)`. The Hermite form `H` is an upper triangular matrix.

`[U,H] = hermiteForm(A)` returns the Hermite normal form of `A` and a unimodular transformation matrix `U`, such that $H = U*A$.

`___ = hermiteForm(A,var)` assumes that the elements of `A` are univariate polynomials in the specified variable `var`. If `A` contains other variables, `hermiteForm` treats those variables as symbolic parameters.

You can use the input argument `var` in any of the previous syntaxes.

If `A` does not contain `var`, then `hermiteForm(A)` and `hermiteForm(A,var)` return different results.

Examples

Hermite Form for Matrix of Integers

Find the Hermite form of an inverse Hilbert matrix.

```
A = sym(invhilb(5))
H = hermiteForm(A)
```

```
A =
[ 25, -300, 1050, -1400, 630]
[ -300, 4800, -18900, 26880, -12600]
[ 1050, -18900, 79380, -117600, 56700]
[ -1400, 26880, -117600, 179200, -88200]
[ 630, -12600, 56700, -88200, 44100]
```

```
H =
[ 5, 0, -210, -280, 630]
[ 0, 60, 0, 0, 0]
[ 0, 0, 420, 0, 0]
[ 0, 0, 0, 840, 0]
[ 0, 0, 0, 0, 2520]
```

Hermite Form for Matrix of Univariate Polynomials

Create a 2-by-2 matrix, the elements of which are polynomials in the variable x .

```
syms x
A = [x^2 + 3, (2*x - 1)^2; (x + 2)^2, 3*x^2 + 5]

A =
[ x^2 + 3, (2*x - 1)^2]
[ (x + 2)^2, 3*x^2 + 5]
```

Find the Hermite form of this matrix.

```
H = hermiteForm(A)

H =
[ 1, (4*x^3)/49 + (47*x^2)/49 - (76*x)/49 + 20/49]
[ 0, x^4 + 12*x^3 - 13*x^2 - 12*x - 11]
```

Hermite Form for Matrix of Multivariate Polynomials

Create a 2-by-2 matrix that contains two variables: x and y .

```
syms x y
A = [2/x + y, x^2 - y^2; 3*sin(x) + y, x]

A =
[ y + 2/x, x^2 - y^2]
[ y + 3*sin(x), x]
```

Find the Hermite form of this matrix. If you do not specify the polynomial variable, `hermiteForm` uses `symvar(A,1)` and thus determines that the polynomial variable is x . Because $3*\sin(x) + y$ is not a polynomial in x , `hermiteForm` throws an error.

```
H = hermiteForm(A)
```

```
Error using mupadengine/feval (line 163)
Cannot convert the matrix entries to integers or univariate polynomials.
```

Find the Hermite form of A specifying that all elements of A are polynomials in the variable y .

```
H = hermiteForm(A,y)

H =
[ 1, (x*y^2)/(3*x*sin(x) - 2) + (x*(x - x^2))/(3*x*sin(x) - 2)]
[ 0, 3*y^2*sin(x) - 3*x^2*sin(x) + y^3 + y*(- x^2 + x) + 2]
```

Hermite Form and Transformation Matrix

Find the Hermite form and the corresponding transformation matrix for an inverse Hilbert matrix.

```
A = sym(invhilb(3));
[U,H] = hermiteForm(A)

U =
[ 13, 9, 7]
[ 6, 4, 3]
[ 20, 15, 12]
```

```
H =
[ 3,  0, 30]
[ 0, 12,  0]
[ 0,  0, 60]
```

Verify that $H = U*A$.

```
isAlways(H == U*A)
```

```
ans =
 3x3 logical array
   1   1   1
   1   1   1
   1   1   1
```

Find the Hermite form and the corresponding transformation matrix for a matrix of polynomials.

```
syms x y
A = [2*(x - y), 3*(x^2 - y^2);
     4*(x^3 - y^3), 5*(x^4 - y^4)];
[U,H] = hermiteForm(A,x)
```

```
U =
[          1/2,  0]
[ 2*x^2 + 2*x*y + 2*y^2, -1]
```

```
H =
[ x - y,          (3*x^2)/2 - (3*y^2)/2]
[  0, x^4 + 6*x^3*y - 6*x*y^3 - y^4]
```

Verify that $H = U*A$.

```
isAlways(H == U*A)
```

```
ans =
 2x2 logical array
   1   1
   1   1
```

If You Specify Variable for Integer Matrix

If a matrix does not contain a particular variable, and you call `hermiteForm` specifying that variable as the second argument, then the result differs from what you get without specifying that variable. For example, create a matrix that does not contain any variables.

```
A = [9 -36 30; -36 192 -180; 30 -180 180]
```

```
A =
   9   -36   30
  -36   192  -180
   30  -180   180
```

Call `hermiteForm` specifying variable `x` as the second argument. In this case, `hermiteForm` assumes that the elements of `A` are univariate polynomials in `x`.

```
syms x
hermiteForm(A,x)
```

```
ans =
   1   0   0
```

$$\begin{bmatrix} 0 & 1 & 0 \\ 0 & 0 & 1 \end{bmatrix}$$

Call `hermiteForm` without specifying variables. In this case, `hermiteForm` treats A as a matrix of integers.

```
hermiteForm(A)
```

```
ans =
     3     0    30
     0    12     0
     0     0    60
```

Input Arguments

A — Input matrix

symbolic matrix

Input matrix, specified as a symbolic matrix, the elements of which are integers or univariate polynomials. If the elements of A contain more than one variable, use the `var` argument to specify a polynomial variable, and treat all other variables as symbolic parameters. If A is multivariate, and you do not specify `var`, then `hermiteForm` uses `symvar(A, 1)` to determine a polynomial variable.

var — Polynomial variable

symbolic variable

Polynomial variable, specified as a symbolic variable.

Output Arguments

H — Hermite normal form of input matrix

symbolic matrix

Hermite normal form of input matrix, returned as a symbolic matrix. The Hermite form of a matrix is an upper triangular matrix.

U — Transformation matrix

unimodular symbolic matrix

Transformation matrix, returned as a unimodular symbolic matrix. If elements of A are integers, then elements of U are also integers, and $\det(U) = 1$ or $\det(U) = -1$. If elements of A are polynomials, then elements of U are univariate polynomials, and $\det(U)$ is a constant.

More About

Hermite Normal Form

For any square n -by- n matrix A with integer coefficients, there exists an n -by- n matrix H and an n -by- n unimodular matrix U , such that $A*U = H$, where H is the Hermite normal form of A . A unimodular matrix is a real square matrix, such that its determinant equals 1 or -1. If A is a matrix of polynomials, then the determinant of U is a constant.

hermiteForm returns the Hermite normal form of a nonsingular integer square matrix A as an upper triangular matrix H , such that $H_{jj} \geq 0$ and $-\frac{H_{jj}}{2} < H_{ij} \leq \frac{H_{jj}}{2}$ for $j > i$. If A is not a square matrix or a singular matrix, the matrix H is simply an upper triangular matrix.

See Also

jordan | smithForm

Introduced in R2015b

hermiteH

Hermite polynomials

Syntax

```
hermiteH(n,x)
```

Description

`hermiteH(n,x)` represents the n th-degree Hermite polynomial at the point x .

Examples

First Five Hermite Polynomials

Find the first five Hermite polynomials for the variable x .

```
syms x
hermiteH([0 1 2 3 4], x)

ans =
[ 1, 2*x, 4*x^2 - 2, 8*x^3 - 12*x, 16*x^4 - 48*x^2 + 12]
```

Hermite Polynomials for Numeric and Symbolic Arguments

Depending on whether the input is numeric or symbolic, `hermiteH` returns numeric or exact symbolic results.

Find the value of the fifth-degree Hermite polynomial at $1/3$. Because the input is numeric, `hermiteH` returns numeric results.

```
hermiteH(5,1/3)
```

```
ans =
    34.2058
```

Find the same result for exact symbolic input. `hermiteH` returns an exact symbolic result.

```
hermiteH(5,sym(1/3))
```

```
ans =
8312/243
```

Plot Hermite Polynomials

Plot the first five Hermite polynomials.

```
syms x y
fplot(hermiteH(0:4,x))
```

```

axis([-2 2 -30 30])
grid on

ylabel('H_n(x)')
legend('H_0(x)', 'H_1(x)', 'H_2(x)', 'H_3(x)', 'H_4(x)', 'Location', 'Best')
title('Hermite polynomials')

```

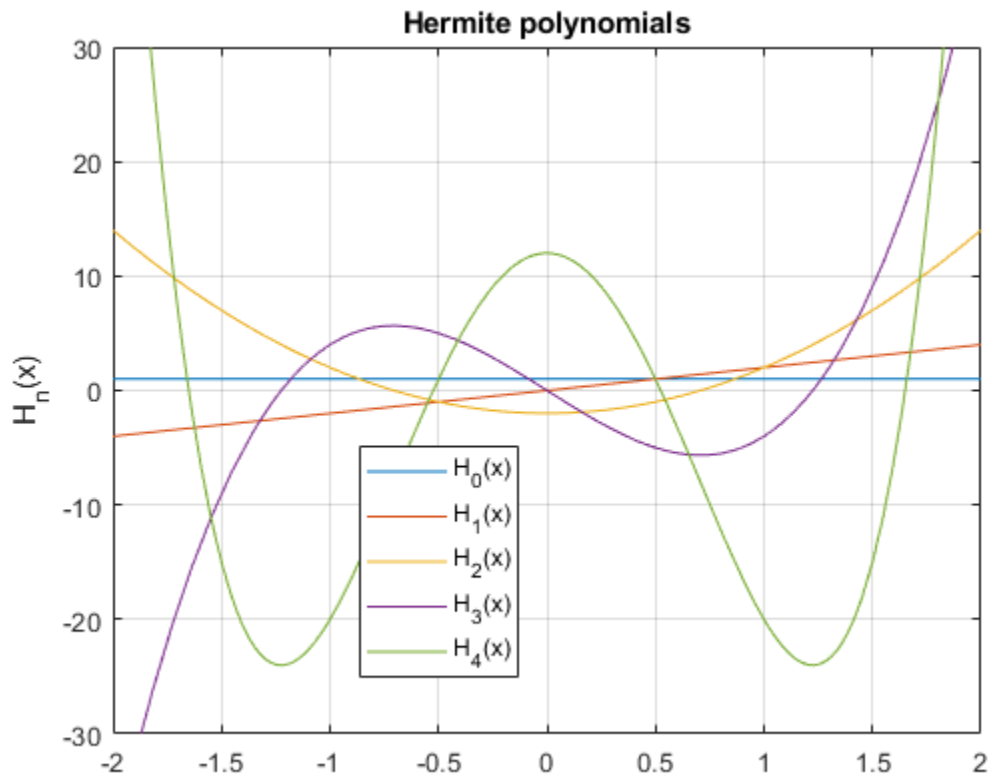

Input Arguments

n — Degree of polynomial

nonnegative integer | symbolic variable | symbolic expression | symbolic function | vector | matrix

Degree of the polynomial, specified as a nonnegative integer, symbolic variable, expression, or function, or as a vector or matrix of numbers, symbolic numbers, variables, expressions, or functions.

x — Input

number | vector | matrix | array | symbolic number | symbolic variable | symbolic array | symbolic function | symbolic expression

Input, specified as a number, vector, matrix, or array, or a symbolic number, variable, array, function, or expression.

More About

Hermite Polynomials

Hermite polynomials are defined by this recursion formula.

$$H(0, x) = 1, \quad H(1, x) = 2x, \quad H(n, x) = 2xH(n-1, x) - 2(n-1)H(n-2, x)$$

Hermite polynomials in MATLAB satisfy this normalization.

$$\int_{-\infty}^{\infty} (H_n(x))^2 e^{-x^2} dx = 2^n \sqrt{\pi} n!$$

Tips

- `hermiteH` returns floating-point results for numeric arguments that are not symbolic objects.
- `hermiteH` acts element-wise on nonscalar inputs.
- At least one input argument must be a scalar or both arguments must be vectors or matrices of the same size. If one input argument is a scalar and the other one is a vector or a matrix, then `hermiteH` expands the scalar into a vector or matrix of the same size as the other argument with all elements equal to that scalar.

References

- [1] Hochstrasser, U. W. "Orthogonal Polynomials." *Handbook of Mathematical Functions with Formulas, Graphs, and Mathematical Tables*. (M. Abramowitz and I. A. Stegun, eds.). New York: Dover, 1972.

See Also

`chebyshevT` | `chebyshevU` | `gegenbauerC` | `jacobiP` | `laguerreL` | `legendreP`

Introduced in R2014b

hessian

Hessian matrix of scalar function

Syntax

```
hessian(f,v)
```

Description

`hessian(f,v)` finds the Hessian matrix on page 4-708 of the scalar function `f` with respect to vector `v` in Cartesian coordinates.

If you do not specify `v`, then `hessian(f)` finds the Hessian matrix of the scalar function `f` with respect to a vector constructed from all symbolic variables found in `f`. The order of variables in this vector is defined by `symvar`.

Examples

Find Hessian Matrix of Scalar Function

Find the Hessian matrix of a function by using `hessian`. Then find the Hessian matrix of the same function as the Jacobian of the gradient of the function.

Find the Hessian matrix of this function of three variables:

```
syms x y z
f = x*y + 2*z*x;
hessian(f,[x,y,z])
```

```
ans =
[ 0, 1, 2]
[ 1, 0, 0]
[ 2, 0, 0]
```

Alternatively, compute the Hessian matrix of this function as the Jacobian of the gradient of that function:

```
jacobian(gradient(f))
```

```
ans =
[ 0, 1, 2]
[ 1, 0, 0]
[ 2, 0, 0]
```

Input Arguments

f — Scalar function

symbolic expression | symbolic function

Scalar function, specified as symbolic expression or symbolic function.

v – Vector with respect to which you find Hessian matrix

symbolic vector

Vector with respect to which you find Hessian matrix, specified as a symbolic vector. By default, `v` is a vector constructed from all symbolic variables found in `f`. The order of variables in this vector is defined by `symvar`.

If `v` is an empty symbolic object, such as `sym([])`, then `hessian` returns an empty symbolic object.

More About**Hessian Matrix**

The Hessian matrix of $f(x)$ is the square matrix of the second partial derivatives of $f(x)$.

$$H(f) = \begin{bmatrix} \frac{\partial^2 f}{\partial x_1^2} & \frac{\partial^2 f}{\partial x_1 \partial x_2} & \cdots & \frac{\partial^2 f}{\partial x_1 \partial x_n} \\ \frac{\partial^2 f}{\partial x_2 \partial x_1} & \frac{\partial^2 f}{\partial x_2^2} & \cdots & \frac{\partial^2 f}{\partial x_2 \partial x_n} \\ \vdots & \vdots & \ddots & \vdots \\ \frac{\partial^2 f}{\partial x_n \partial x_1} & \frac{\partial^2 f}{\partial x_n \partial x_2} & \cdots & \frac{\partial^2 f}{\partial x_n^2} \end{bmatrix}$$

See Also

`curl` | `diff` | `divergence` | `gradient` | `jacobian` | `laplacian` | `potential` | `vectorPotential`

Introduced in R2011b

horner

Horner nested polynomial representation

Syntax

```
horner(p)
horner(p, var)
```

Description

`horner(p)` returns the Horner form of the polynomial `p`.

`horner(p, var)` uses the variable in `var`.

Examples

Horner Form of Polynomial

Find the Horner representation of a polynomial.

```
syms x
p = x^3 - 6*x^2 + 11*x - 6;
horner(p)
```

```
ans =
x*(x*(x - 6) + 11) - 6
```

Specify the variable in the polynomial by using the second argument.

```
syms a b y
p = a*y*x^3 - y*x^2 - 11*b*y*x + 2;
horner(p, x)
```

```
ans =
2 - x*(11*b*y + x*(y - a*x*y))
```

```
horner(p, y)
```

```
ans =
2 - y*(- a*x^3 + x^2 + 11*b*x)
```

Input Arguments

p — Polynomial

symbolic expression | symbolic function | array of symbolic expressions | array of symbolic functions

Polynomial, specified as a symbolic expression or function, or an array of symbolic expressions or functions.

var — Variable

symbolic variable | array of symbolic variables

Variable, specified as a symbolic variable or an array of symbolic variables.

See Also

`collect` | `combine` | `expand` | `factor` | `numden` | `rewrite` | `simplify` | `simplifyFraction`

Introduced before R2006a

horzcat

Concatenate symbolic arrays horizontally

Syntax

```
horzcat(A1,...,AN)  
[A1 ... AN]
```

Description

`horzcat(A1,...,AN)` horizontally concatenates the symbolic arrays `A1,...,AN`. For vectors and matrices, all inputs must have the same number of rows. For multidimensional arrays, `horzcat` concatenates inputs along the second dimension. The remaining dimensions must match.

`[A1 ... AN]` is a shortcut for `horzcat(A1,...,AN)`.

Examples

Concatenate Two Symbolic Matrices Horizontally

Create matrices A and B.

```
A = sym('a%d%d',[2 2])  
B = sym('b%d%d',[2 2])
```

```
A =  
[ a11, a12]  
[ a21, a22]  
B =  
[ b11, b12]  
[ b21, b22]
```

Concatenate A and B.

```
horzcat(A,B)
```

```
ans =  
[ a11, a12, b11, b12]  
[ a21, a22, b21, b22]
```

Alternatively, use the shortcut `[A B]`.

```
[A B]
```

```
ans =  
[ a11, a12, b11, b12]  
[ a21, a22, b21, b22]
```

Concatenate Multiple Symbolic Arrays Horizontally

```
A = sym('a%d',[3 1]);  
B = sym('b%d%d',[3 3]);
```

```
C = sym('c%d%d',[3 2]);  
horzcat(C,A,B)
```

```
ans =  
[ c11, c12, a1, b11, b12, b13]  
[ c21, c22, a2, b21, b22, b23]  
[ c31, c32, a3, b31, b32, b33]
```

Alternatively, use the shortcut `[C A B]`.

```
[C A B]
```

```
ans =  
[ c11, c12, a1, b11, b12, b13]  
[ c21, c22, a2, b21, b22, b23]  
[ c31, c32, a3, b31, b32, b33]
```

Concatenate Multidimensional Arrays Horizontally

Create the 3-D symbolic arrays A and B.

```
A = sym('a%d%d',[2 3]);  
A(:,:,2) = -A  
B = sym('b%d%d',[2 2]);  
B(:,:,2) = -B
```

```
A(:,:,1) =  
[ a11, a12, a13]  
[ a21, a22, a23]  
A(:,:,2) =  
[ -a11, -a12, -a13]  
[ -a21, -a22, -a23]
```

```
B(:,:,1) =  
[ b11, b12]  
[ b21, b22]  
B(:,:,2) =  
[ -b11, -b12]  
[ -b21, -b22]
```

Use `horzcat` to concatenate A and B.

```
horzcat(A,B)
```

```
ans(:,:,1) =  
[ a11, a12, a13, b11, b12]  
[ a21, a22, a23, b21, b22]  
ans(:,:,2) =  
[ -a11, -a12, -a13, -b11, -b12]  
[ -a21, -a22, -a23, -b21, -b22]
```

Alternatively, use the shortcut `[A B]`.

```
[A B]
```

```
ans(:,:,1) =  
[ a11, a12, a13, b11, b12]  
[ a21, a22, a23, b21, b22]  
ans(:,:,2) =
```

```
[ -a11, -a12, -a13, -b11, -b12]  
[ -a21, -a22, -a23, -b21, -b22]
```

Input Arguments

A1, . . . , AN — Input arrays

symbolic variable | symbolic vector | symbolic matrix | symbolic multidimensional array

Input arrays, specified as symbolic variables, vectors, matrices, or multidimensional arrays.

See Also

cat | vertcat

Introduced before R2006a

htrans

Hilbert transform

Syntax

```
H = htrans(f)
H = htrans(f,transVar)
H = htrans(f,var,transVar)
```

Description

`H = htrans(f)` returns the Hilbert transform of symbolic function `f`. By default, the independent variable is `t` and the transformation variable is `x`.

`H = htrans(f,transVar)` uses the transformation variable `transVar` instead of `x`.

`H = htrans(f,var,transVar)` uses the independent variable `var` and the transformation variable `transVar` instead of `t` and `x`, respectively.

- If all input arguments are arrays of the same size, then `htrans` acts element-wise.
- If one input is a scalar and the others are arrays of the same size, then `htrans` expands the scalar into an array of the same size.
- If `f` is an array of symbolic expressions with different independent variables, then `var` must be a symbolic array with elements corresponding to the independent variables.

Examples

Transform Symbolic Expression

Compute the Hilbert transform of `sin(t)`. By default, the transform returns a function of `x`.

```
syms t;
f = sin(t);
H = htrans(f)
```

```
H = -cos(x)
```

Transform Sinc Function

Compute the Hilbert transform of the `sinc` function, which is equal to $\sin(\pi x)/\pi x$. Express the result as a function of `u`.

```
syms f(x) H(u);
f(x) = sinc(x);
H(u) = htrans(f,u)
```

```
H(u) =
```

$$\frac{\frac{\cos(\pi u)}{u} - \frac{1}{u}}{\pi}$$

Plot the sinc function and its Hilbert transform.

```
fplot(f(x),[0 6])
hold on
fplot(H(u),[0 6])
legend('sinc(x)', 'H(u)')
```

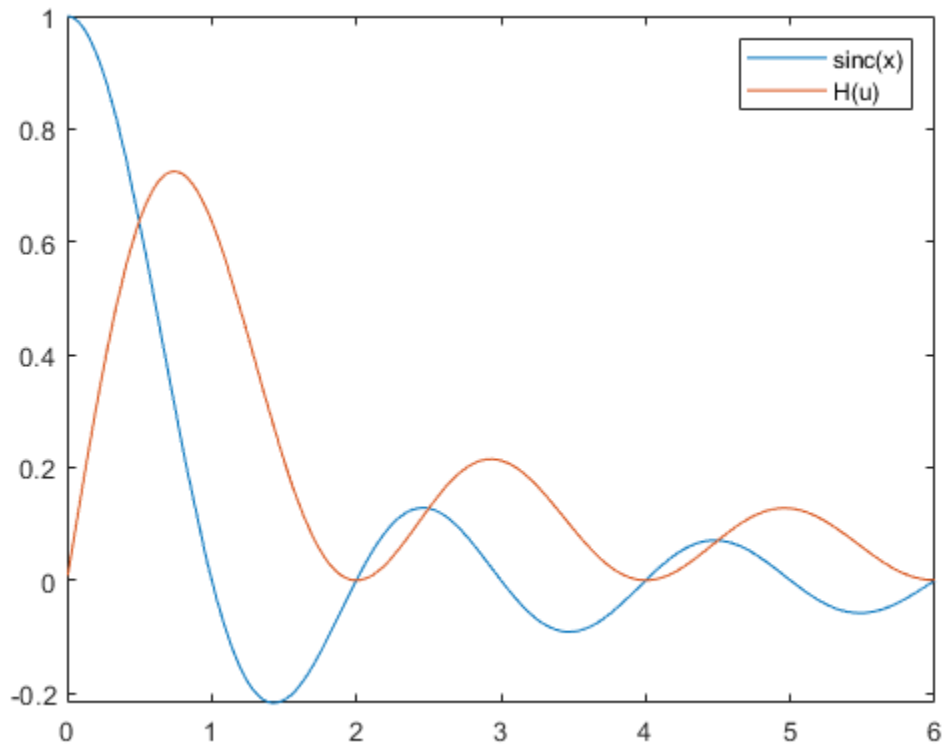

Apply Phase Shifts

Create a sine wave with a positive frequency in real space.

```
syms A x t u;
assume([x t], 'real')
y = A*sin(2*pi*10*t + 5*x)
```

$$y = A \sin(5x + 20\pi t)$$

Apply a -90-degree phase shift to the positive frequency component using the Hilbert transform. Specify the independent variable as t and the transformation variable as u.

$$H = \text{htrans}(y, t, u)$$

$$H = -A \cos(5x + 20\pi u)$$

Now create a complex signal with negative frequency. Apply a 90-degree phase shift to the negative frequency component using the Hilbert transform.

$$z = A \exp(-1i \cdot 10 \cdot t)$$

$$z = A e^{-10ti}$$

$$H = \text{htrans}(z)$$

$$H = A e^{-10xi} i$$

Calculate Instantaneous Frequency

Create a real-valued signal $f(t)$ with two frequency components, 60 Hz and 90 Hz.

```
syms t f(t) F(s)
f(t) = sin(2*pi*60*t) + sin(2*pi*90*t)
```

$$f(t) = \sin(120\pi t) + \sin(180\pi t)$$

Calculate the corresponding analytic signal $F(s)$ using the Hilbert transform.

$$F(s) = f(s) + 1i \cdot \text{htrans}(f(t), s)$$

$$F(s) = \sin(120\pi s) + \sin(180\pi s) - \cos(120\pi s) i - \cos(180\pi s) i$$

Calculate the instantaneous frequency of $F(s)$ using

$$f_{\text{instant}}(s) = \frac{1}{2\pi} \frac{d\phi(s)}{ds},$$

where $\phi(s) = \arg[F(s)]$ is the instantaneous phase of the analytic signal.

```
InstantFreq(s) = diff(angle(F(s)), s)/(2*pi);
assume(s, 'real')
simplify(InstantFreq(s))
```

$$\text{ans} = 75$$

Input Arguments

f — Input

symbolic expression | symbolic function | symbolic vector | symbolic matrix

Input, specified as a symbolic expression, symbolic function, symbolic vector, or symbolic matrix.

var — Independent variable

t (default) | symbolic variable | symbolic vector | symbolic matrix

Independent variable, specified as a symbolic variable, symbolic vector, or symbolic matrix. This variable is usually in the time domain. If you do not specify the variable, then `htrans` uses `t` by

default. If f does not contain t , then `htrans` uses the function `symvar` to determine the independent variable.

transVar — Transformation variable

`x` (default) | `v` | symbolic variable | symbolic vector | symbolic matrix

Transformation variable, specified as a symbolic variable, symbolic vector, or symbolic matrix. This variable is in the same domain as `var`. If you do not specify the variable, then `htrans` uses `x` by default. If `x` is the independent variable of `f`, then `htrans` uses the transformation variable `v`.

Output Arguments

H — Hilbert transform of f

symbolic expression | symbolic function | symbolic vector | symbolic matrix

Hilbert transform or harmonic conjugate of the input function `f`. The output `H` is a function of the variable specified by `transVar`.

When `htrans` cannot transform the input function, it returns an unevaluated call. To return the original expression, apply the inverse Hilbert transform to the output by using `ihtrans`.

More About

Hilbert Transform

The Hilbert transform $H = H(x)$ of the expression $f = f(t)$ with respect to the variable t at point x is

$$H(x) = \frac{1}{\pi} \text{p.v.} \int_{-\infty}^{\infty} \frac{f(t)}{x-t} dt.$$

Here, p.v. represents the Cauchy principal value of the integral. The function $f(t)$ can be complex, but t and x must be real.

Tips

- To compute the inverse Hilbert transform, use `ihtrans`. The Hilbert transform of a function is equal to the negative of its inverse Hilbert transform.
- For a signal in the time domain, the Hilbert transform applies a -90-degree phase shift to positive frequencies of the corresponding Fourier components. It also applies a 90-degree phase shift to negative frequencies.
- For a real-valued signal `a`, the Hilbert transform `b = htrans(a)` returns its harmonic conjugate `b`. The real signal `a = real(z)` and its Hilbert transform `b = imag(z)` form the analytic signal $z = a + 1i*b$.

See Also

`fourier` | `ifourier` | `ihtrans` | `ilaplace` | `laplace`

Introduced in R2019a

hurwitzZeta

Hurwitz zeta function

Syntax

```
Z = hurwitzZeta(s,a)
Z = hurwitzZeta(n,s,a)
```

Description

`Z = hurwitzZeta(s,a)` evaluates the Hurwitz zeta function on page 4-721 for the numeric or symbolic inputs `s` and `a`. The Hurwitz zeta function is defined only if `s` is not 1 and `a` is neither 0 nor a negative integer.

`Z = hurwitzZeta(n,s,a)` returns the `n`th derivative of `hurwitzZeta(s,a)` with respect to the variable `s`.

Examples

Numeric and Symbolic Inputs

Evaluate the Hurwitz zeta function with numeric input arguments.

```
Z = hurwitzZeta(0,1)
```

```
Z = -0.5000
```

Compute the symbolic output of `hurwitzZeta` by converting the inputs to symbolic numbers using `sym`.

```
symZ = hurwitzZeta(sym([0 2]),1)
```

```
symZ =  
 $\left(-\frac{1}{2} \frac{\pi^2}{6}\right)$ 
```

Use the `vpa` function to approximate symbolic results with the default 32 digits of precision.

```
valZ = vpa(symZ)
```

```
valZ = (-0.5 1.644934066848226436472415166646)
```

Special Values

For certain parameter values, symbolic evaluation of the Hurwitz zeta function returns special values that are related to other symbolic functions.

For `a = 1`, the Hurwitz zeta function returns the Riemann zeta function `zeta`.

```
syms s a;
Z = hurwitzZeta(s,1)
```

$$Z = \zeta(s)$$

For $s = 2$, the Hurwitz zeta function returns the first derivative of the digamma function ψ .

```
Z = hurwitzZeta(2,a)
```

$$Z = \psi'(a)$$

For nonpositive integers s , the Hurwitz zeta function returns polynomials in terms of a .

```
Z = hurwitzZeta(0,a)
```

$$Z = \frac{1}{2} - a$$

```
Z = hurwitzZeta(-1,a)
```

$$Z = -\frac{a^2}{2} + \frac{a}{2} - \frac{1}{12}$$

```
Z = hurwitzZeta(-2,a)
```

$$Z = -\frac{a^3}{3} + \frac{a^2}{2} - \frac{a}{6}$$

Differentiate Hurwitz Zeta Function

Find the first derivative of the Hurwitz zeta function with respect to the variable s .

```
syms s a
Z = hurwitzZeta(1,s,a)
```

$$Z = \zeta'(s, a)$$

Evaluate the first derivative at $s = 0$ and $a = 1$ by using the `subs` function.

```
symZ = subs(Z,[s a],[0 1])
```

$$\text{symZ} = -\frac{\log(2)}{2} - \frac{\log(\pi)}{2}$$

Use the `diff` function to find the first derivative of the Hurwitz zeta function with respect to a .

```
Z = diff(hurwitzZeta(s,a),a)
```

$$Z = -s\zeta(s+1, a)$$

Plot Hurwitz Zeta Function

Plot the Hurwitz zeta function for s within the interval $[-20\ 10]$, given $a = 0.7$.

```
fplot(@(s) hurwitzZeta(s,0.7),[-20 10])
axis([-20 10 -40 35]);
```

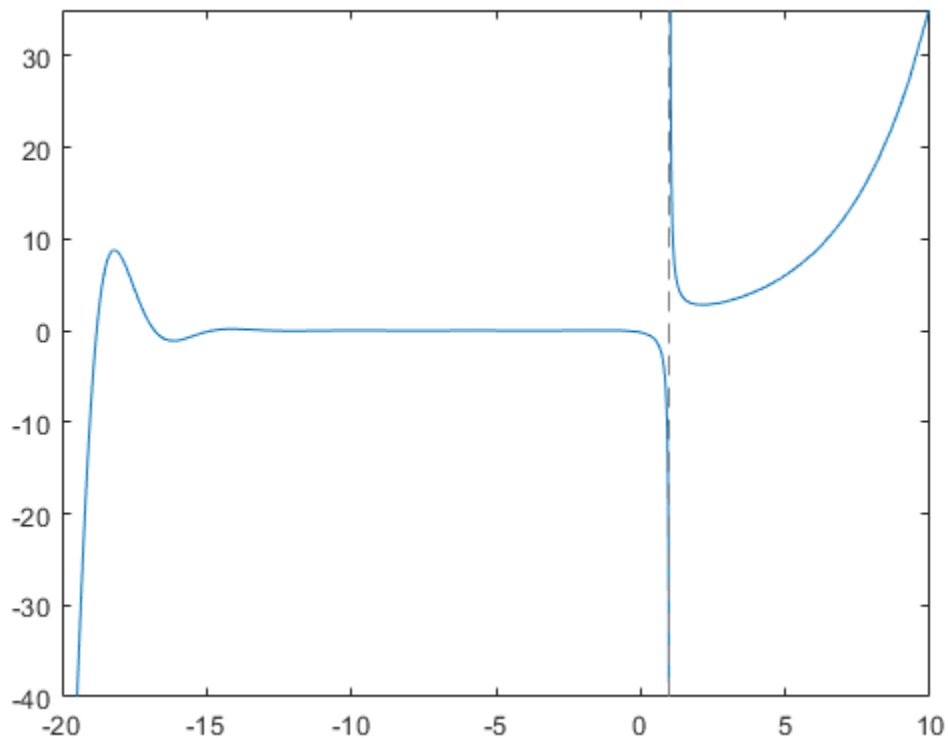

Input Arguments

s – Input

number | array | symbolic number | symbolic variable | symbolic function | symbolic expression | symbolic array

Input, specified as a number, array, symbolic number, symbolic variable, symbolic function, symbolic expression, or symbolic array. The Hurwitz zeta function is defined only for values of s not equal to 1.

Data Types: single | double | sym | symfun

Complex Number Support: Yes

a – Input

number | array | symbolic number | symbolic variable | symbolic function | symbolic expression | symbolic array

Input, specified as a number, array, symbolic number, symbolic variable, symbolic function, symbolic expression, or symbolic array. The Hurwitz zeta function is defined only for values of a not equal to 0 or a negative integer.

Data Types: `single` | `double` | `sym` | `symfun`
 Complex Number Support: Yes

n — Order of derivative

nonnegative integer

Order of derivative, specified as a nonnegative integer.

More About

Hurwitz Zeta Function

The Hurwitz zeta function is defined by the formula

$$\zeta(s, a) = \sum_{k=0}^{\infty} \frac{1}{(k+a)^s}.$$

The summation series converges only when $\text{Re}(s) > 1$ and a is neither 0 nor a negative integer. Analytic continuation extends the definition of the function to the entire complex plane, except for a simple pole at $s = 1$.

Tips

- Floating-point evaluation of the Hurwitz zeta function can be slow for complex arguments or high-precision numbers. To increase the computational speed, you can reduce the floating-point precision by using the `vpa` and `digits` functions. For more information, see “Increase Speed by Reducing Precision” on page 2-134.
- The Hurwitz zeta function is related to other special functions. For example, it can be expressed in terms of the polylogarithm $\text{Li}_s(z)$ and the gamma function $\Gamma(z)$:

$$\zeta(1-s, a) = \frac{\Gamma(s)}{(2\pi)^s} \left[e^{-i\pi s/2} \text{Li}_s(e^{2\pi i a}) + e^{i\pi s/2} \text{Li}_s(e^{-2\pi i a}) \right].$$

Here, $\text{Re}(s) > 0$ and $\text{Im}(a) > 0$, or $\text{Re}(s) > 1$ and $\text{Im}(a) = 0$.

References

- [1] Olver, F. W. J., A. B. Olde Daalhuis, D. W. Lozier, B. I. Schneider, R. F. Boisvert, C. W. Clark, B. R. Miller, and B. V. Saunders, eds., Chapter 25. Zeta and Related Functions, *NIST Digital Library of Mathematical Functions*, Release 1.0.20, Sept. 15, 2018.

See Also

`bernoulli` | `gamma` | `polylog` | `psi` | `zeta`

Introduced in R2019a

hypergeom

Hypergeometric function

Syntax

`hypergeom(a, b, z)`

Description

`hypergeom(a, b, z)` represents the generalized hypergeometric function on page 4-724.

Examples

Hypergeometric Function for Numeric and Symbolic Arguments

Depending on whether the input is floating point or symbolic, `hypergeom` returns floating point or symbolic results.

Compute the hypergeometric function for these numbers. Because these numbers are floating point, `hypergeom` returns floating-point results.

```
A = [hypergeom([1 2], 2.5, 2),...
     hypergeom(1/3, [2 3], pi),...
     hypergeom([1 1/2], 1/3, 3*i)]

A =
-1.2174 - 0.83330i   1.2091 + 0.00000i   -0.2028 + 0.2405i
```

Return exact symbolic results by converting at least one of the inputs to symbolic form by using `sym`. For most symbolic (exact) inputs, `hypergeom` returns unresolved symbolic calls.

```
symA = [hypergeom([1 2], 2.5, sym(2)),...
        hypergeom(1/3, [2 3], sym(pi)),...
        hypergeom([1 1/2], sym(1/3), 3*i)]

symA =
[ hypergeom([1, 2], 5/2, 2), hypergeom(1/3, [2, 3], pi), hypergeom([1/2, 1], 1/3, 3i)]
```

Convert the symbolic result to high-precision floating-point by using `vpa`.

```
vpa(symA)

ans =
[ -1.2174189301051728850455150601879 - 0.83304055090469367131547768563638i,...
  1.2090631887094273193917339575087,...
  -0.20275169745081962937527290365593 + 0.24050134226872040357481317881983i]
```

Special Values of Hypergeometric Function

Show that `hypergeom` returns special values for certain input values.

```
syms a b c d x
hypergeom([], [], x)
```

```
ans =
exp(x)
```

```
hypergeom([a b c d], [a b c d], x)
```

```
ans =
exp(x)
```

```
hypergeom(a, [], x)
```

```
ans =
1/(1 - x)^a
```

Show that the hypergeometric function is always 1 at 0.

```
syms a b c d
hypergeom([a b], [c d], 0)
```

```
ans =
1
```

If, after cancelling identical parameters in the first two arguments, the list of upper parameters contains 0, the resulting hypergeometric function is constant with the value 1. For details, see “Algorithms” on page 4-725.

```
hypergeom([0 0 2 3], [a 0 4], x)
```

```
ans =
1
```

If, after canceling identical parameters in the first two arguments, the upper parameters contain a negative integer larger than the largest negative integer in the lower parameters, the hypergeometric function is a polynomial.

```
hypergeom([-4 -2 3], [-3 1 4], x)
```

```
ans =
(3*x^2)/5 - 2*x + 1
```

Hypergeometric functions reduce to other special functions for certain input values.

```
hypergeom([1], [a], x)
hypergeom([a], [a, b], x)
```

```
ans =
(exp(x/2)*whittakerM(1 - a/2, a/2 - 1/2, -x))/(-x)^(a/2)
```

```
ans =
x^(1/2 - b/2)*gamma(b)*besseli(b - 1, 2*x^(1/2))
```

Handling Expressions That Contain Hypergeometric Functions

Many symbolic functions, such as `diff` and `taylor`, handle expressions containing `hypergeom`.

Differentiate this expression containing the hypergeometric function.

```

syms a b c d x
diff(1/x*hypergeom([a b],[c d],x), x)

ans =
(a*b*hypergeom([a + 1, b + 1], [c + 1, d + 1], x))/(c*d*x)...
- hypergeom([a, b], [c, d], x)/x^2

```

Compute the Taylor series of this hypergeometric function.

```

taylor(hypergeom([1 2],3,x), x)

ans =
(2*x^5)/7 + x^4/3 + (2*x^3)/5 + x^2/2 + (2*x)/3 + 1

```

Input Arguments

a — Upper parameters of hypergeometric function

number | vector | symbolic number | symbolic variable | symbolic expression | symbolic function | symbolic vector

Upper parameters of hypergeometric function, specified as a number, variable, symbolic expression, symbolic function, or vector.

b — Lower parameters of hypergeometric function

number | vector | symbolic number | symbolic variable | symbolic expression | symbolic function | symbolic vector

Lower parameters of hypergeometric function, specified as a number, variable, symbolic expression, symbolic function, or vector.

z — Input

number | vector | matrix | array | symbolic number | symbolic variable | symbolic array | symbolic function | symbolic expression

Input, specified as a number, vector, matrix, or array, or a symbolic number, variable, array, function, or expression.

More About

Generalized Hypergeometric Function

The generalized hypergeometric function of order p , q is defined as follows.

$${}_pF_q(a; b; z) = {}_pF_q(a_1, \dots, a_j, \dots, a_p; b_1, \dots, b_k, \dots, b_q; z) = \sum_{n=0}^{\infty} \left(\frac{(a_1)_n \dots (a_j)_n \dots (a_p)_n}{(b_1)_n \dots (b_k)_n \dots (b_q)_n} \right) \left(\frac{z^n}{n!} \right).$$

Here $a = [a_1, a_2, \dots, a_p]$ and $b = [b_1, b_2, \dots, b_q]$ are vectors of lengths p and q , respectively.

$(a)_k$ and $(b)_k$ are Pochhammer symbols.

For empty vectors a and b , hypergeom is defined as follows.

$${}_0F_q(; b; z) = \sum_{k=0}^{\infty} \frac{1}{(b_1)_k (b_2)_k \dots (b_q)_k} \left(\frac{z^k}{k!} \right)$$

$${}_pF_0(a; ; z) = \sum_{k=0}^{\infty} (a_1)_k (a_2)_k \dots (a_p)_k \left(\frac{z^k}{k!} \right)$$

$${}_0F_0(; ; z) = \sum_{k=0}^{\infty} \left(\frac{z^k}{k!} \right) = e^z.$$

Pochhammer Symbol

$$(x)_n = \frac{\Gamma(x+n)}{\Gamma(x)}.$$

If n is a positive integer, then $(x)_n = x(x+1)\dots(x+n-1)$.

Algorithms

The hypergeometric function is

$${}_pF_q(a; b; z) = {}_pF_q(a_1, \dots, a_j, \dots, a_p; b_1, \dots, b_k, \dots, b_q; z) = \sum_{n=0}^{\infty} \left(\frac{(a_1)_n \dots (a_j)_n \dots (a_p)_n}{(b_1)_n \dots (b_k)_n \dots (b_q)_n} \right) \left(\frac{z^n}{n!} \right).$$

- The hypergeometric function has convergence criteria:
 - Converges if $p \leq q$ and $|z| < \infty$.
 - Converges if $p = q + 1$ and $|z| < 1$. For $|z| \geq 1$, the series diverges, and is defined by analytic continuation.
 - Diverges if $p > q + 1$ and $z \neq 0$. Here, the series is defined by an asymptotic expansion of ${}_pF_q(a; b; z)$ around $z = 0$. The branch cut is the positive real axis.
- The function is a polynomial, called the hypergeometric polynomial, if any a_j is a nonpositive integer.
- The function is undefined:
 - If any b_k is a nonpositive integer such that $b_k > a_j$ where a_j is also a nonpositive integer, because division by 0 occurs
 - If any b_k is a nonpositive integer and no a_j is a nonpositive integer
- The function has reduced order when upper and lower parameter values are equal and cancel. If r values of the upper and lower parameters are equal (that is, $a = [a_1, \dots, a_{p-r}, c_1, \dots, c_r]$, $b = [b_1, \dots, b_{q-r}, c_1, \dots, c_r]$), then the order (p, q) of ${}_pF_q(a; b; z)$ is reduced to $(p-r, q-r)$:

$${}_pF_q(a_1, \dots, a_{p-r}, c_1, \dots, c_r; b_1, \dots, b_{q-r}, c_1, \dots, c_r; z) = {}_{p-r}F_{q-r}(a_1, \dots, a_{p-r}; b_1, \dots, b_{q-r}; z)$$

This rule applies even if any c_i is zero or a negative integer [2].

- ${}_pF_q(a; b; z)$ is symmetric. That is, it does not depend on the order a_1, a_2, \dots in a or b_1, b_2, \dots in b .
- $U(z) = {}_pF_q(a; b; z)$ satisfies the differential equation in z

$$[\delta(\delta + b - 1) - z(\delta + a)]U(z) = 0, \quad \delta = z \frac{\partial}{\partial z}.$$

Here, $(\delta + a)$ represents

$$\prod_{i=1}^p (\delta + a_i).$$

And $(\delta + b)$ represents

$$\prod_{j=1}^q (\delta + b_j).$$

Thus, the order of this differential equation is $\max(p, q + 1)$, and the hypergeometric function is only one of its solutions. If $p < q + 1$, this differential equation has a regular singularity at $z = 0$ and an irregular singularity at $z = \infty$. If $p = q + 1$, the points $z = 0$, $z = 1$, and $z = \infty$ are regular singularities, which explains the convergence properties of the hypergeometric series.

- The hypergeometric function has these special values:
 - ${}_pF_p(a; a; z) = {}_0F_0(; ; z) = e^z$.
 - ${}_pF_q(a; b; z) = 1$ if the list of upper parameters a contains more 0s than the list of lower parameters b .
 - ${}_pF_q(a; b; 0) = 1$.

References

- [1] Oberhettinger, F. "Hypergeometric Functions." *Handbook of Mathematical Functions with Formulas, Graphs, and Mathematical Tables*. (M. Abramowitz and I. A. Stegun, eds.). New York: Dover, 1972.
- [2] Luke, Y.L. "The Special Functions and Their Approximations", Vol. 1, Academic Press, New York, 1969.
- [3] Prudnikov, A.P., Yu.A. Brychkov, and O.I. Marichev, "Integrals and Series", Vol. 3: More Special Functions, Gordon and Breach, 1990.

See Also

kummerU | meijerG | whittakerM | whittakerW

Introduced before R2006a

ifourier

Inverse Fourier transform

Syntax

```
ifourier(F)
ifourier(F,transVar)
ifourier(F,var,transVar)
```

Description

`ifourier(F)` returns the “Inverse Fourier Transform” on page 4-730 of F . By default, the independent variable is w and the transformation variable is x . If F does not contain w , `ifourier` uses the function `symvar`.

`ifourier(F,transVar)` uses the transformation variable `transVar` instead of x .

`ifourier(F,var,transVar)` uses the independent variable `var` and the transformation variable `transVar` instead of w and x , respectively.

Examples

Inverse Fourier Transform of Symbolic Expression

Compute the inverse Fourier transform of $\exp(-w^2/4)$. By default, the inverse transform is in terms of x .

```
syms w
F = exp(-w^2/4);
ifourier(F)

ans =
exp(-x^2)/pi^(1/2)
```

Default Independent Variable and Transformation Variable

Compute the inverse Fourier transform of $\exp(-w^2 - a^2)$. By default, the independent and transformation variables are w and x , respectively.

```
syms a w t
F = exp(-w^2 - a^2);
ifourier(F)

ans =
exp(- a^2 - x^2/4)/(2*pi^(1/2))
```

Specify the transformation variable as `t`. If you specify only one variable, that variable is the transformation variable. The independent variable is still w .

```
ifourier(F,t)

ans =
exp(- a^2 - t^2/4)/(2*pi^(1/2))
```

Inverse Fourier Transforms Involving Dirac and Heaviside Functions

Compute the inverse Fourier transform of expressions in terms of Dirac and Heaviside functions.

```
syms t w
ifourier(dirac(w), w, t)

ans =
1/(2*pi)

f = 2*exp(-abs(w))-1;
ifourier(f,w,t)

ans =
-(2*pi*dirac(t) - 4/(t^2 + 1))/(2*pi)

f = exp(-w)*heaviside(w);
ifourier(f,w,t)

ans =
-1/(2*pi*(- 1 + t*1i))
```

Specify Parameters of Inverse Fourier Transform

Specify parameters of the inverse Fourier transform.

Compute the inverse Fourier transform of this expression using the default values of the Fourier parameters $c = 1$, $s = -1$. For details, see “Inverse Fourier Transform” on page 4-730.

```
syms t w
f = -(sqrt(sym(pi))*w*exp(-w^2/4)*i)/2;
ifourier(f,w,t)

ans =
t*exp(-t^2)
```

Change the Fourier parameters to $c = 1$, $s = 1$ by using `sympref`, and compute the transform again. The sign of the result changes.

```
sympref('FourierParameters',[1 1]);
ifourier(f,w,t)

ans =
-t*exp(-t^2)
```

Change the Fourier parameters to $c = 1/(2\pi)$, $s = 1$. The result changes.

```
sympref('FourierParameters',[1/(2*sym(pi)) 1]);
ifourier(f,w,t)
```

```
ans =
-2*pi*t*exp(-t^2)
```

Preferences set by `sympref` persist through your current and future MATLAB sessions. Restore the default values of `c` and `s` by setting `FourierParameters` to `'default'`.

```
sympref('FourierParameters','default');
```

Inverse Fourier Transform of Array Inputs

Find the inverse Fourier transform of the matrix `M`. Specify the independent and transformation variables for each matrix entry by using matrices of the same size. When the arguments are nonscalars, `ifourier` acts on them element-wise.

```
syms a b c d w x y z
M = [exp(x), 1; sin(y), i*z];
vars = [w, x; y, z];
transVars = [a, b; c, d];
ifourier(M,vars,transVars)

ans =
[ exp(x)*dirac(a), dirac(b)]
[ (dirac(c - 1)*1i)/2 - (dirac(c + 1)*1i)/2, dirac(1, d)]
```

If `ifourier` is called with both scalar and nonscalar arguments, then it expands the scalars to match the nonscalars by using scalar expansion. Nonscalar arguments must be the same size.

```
ifourier(x,vars,transVars)

ans =
[ x*dirac(a), -dirac(1, b)*1i]
[ x*dirac(c), x*dirac(d)]
```

If Inverse Fourier Transform Cannot Be Found

If `ifourier` cannot transform the input, then it returns an unevaluated call to `fourier`.

```
syms F(w) t
f = ifourier(F,w,t)

f =
fourier(F(w), w, -t)/(2*pi)
```

Input Arguments

F — Input

symbolic expression | symbolic function | symbolic vector | symbolic matrix

Input, specified as a symbolic expression, function, vector, or matrix.

var — Independent variable

`x` (default) | symbolic variable

Independent variable, specified as a symbolic variable. This variable is often called the "frequency variable." If you do not specify the variable, then `ifourier` uses `w`. If `F` does not contain `w`, then `ifourier` uses the function `symvar` to determine the independent variable.

transVar — Transformation variable

`x` (default) | `t` | symbolic variable | symbolic expression | symbolic vector | symbolic matrix

Transformation variable, specified as a symbolic variable, expression, vector, or matrix. It is often called the "time variable" or "space variable." By default, `ifourier` uses `x`. If `x` is the independent variable of `F`, then `ifourier` uses `t`.

More About

Inverse Fourier Transform

The inverse Fourier transform of the expression $F = F(w)$ with respect to the variable w at the point x is

$$f(x) = \frac{|s|}{2\pi c} \int_{-\infty}^{\infty} F(w) e^{-iswx} dw.$$

c and s are parameters of the inverse Fourier transform. The `ifourier` function uses $c = 1$, $s = -1$.

Tips

- If any argument is an array, then `ifourier` acts element-wise on all elements of the array.
- If the first argument contains a symbolic function, then the second argument must be a scalar.
- The toolbox computes the inverse Fourier transform via the Fourier transform:

$$\text{ifourier}(F, w, t) = \frac{1}{2\pi} \text{fourier}(F, w, -t).$$

If `ifourier` cannot find an explicit representation of the inverse Fourier transform, then it returns results in terms of the Fourier transform.

- To compute the Fourier transform, use `fourier`.

References

- [1] Oberhettinger, F. "Tables of Fourier Transforms and Fourier Transforms of Distributions." Springer, 1990.

See Also

`fourier` | `ilaplace` | `iztrans` | `laplace` | `sympref` | `ztrans`

Topics

"Fourier and Inverse Fourier Transforms" on page 2-214

Introduced before R2006a

igamma

Incomplete gamma function

Syntax

```
igamma(nu,z)
```

Description

`igamma(nu,z)` returns the incomplete gamma function.

`igamma` uses the definition of the upper incomplete gamma function on page 4-732. The MATLAB `gammainc` function uses the definition of the lower incomplete gamma function on page 4-732, $\text{gammainc}(z, \text{nu}) = 1 - \text{igamma}(\text{nu}, z)/\text{gamma}(\text{nu})$. The order of input arguments differs between these functions.

Examples

Compute Incomplete Gamma Function for Numeric and Symbolic Arguments

Depending on its arguments, `igamma` returns floating-point or exact symbolic results.

Compute the incomplete gamma function for these numbers. Because these numbers are not symbolic objects, you get floating-point results.

```
A = [igamma(0, 1), igamma(3, sqrt(2)), igamma(pi, exp(1)), igamma(3, Inf)]
```

```
A =
    0.2194    1.6601    1.1979         0
```

Compute the incomplete gamma function for the numbers converted to symbolic objects:

```
symA = [igamma(sym(0), 1), igamma(3, sqrt(sym(2))),...
        igamma(sym(pi), exp(sym(1))), igamma(3, sym(Inf))]
```

```
symA =
[ -ei(-1), exp(-2^(1/2))*(2*2^(1/2) + 4), igamma(pi, exp(1)), 0]
```

Use `vpa` to approximate symbolic results with floating-point numbers:

```
vpa(symA)
```

```
ans =
[ 0.21938393439552027367716377546012,...
  1.6601049038903044104826564373576,...
  1.1979302081330828196865548471769,...
  0]
```

Compute Lower Incomplete Gamma Function

`igamma` is implemented according to the definition of the upper incomplete gamma function. If you want to compute the lower incomplete gamma function, convert results returned by `igamma` as follows.

Compute the lower incomplete gamma function for these arguments using the MATLAB `gammainc` function:

```
A = [-5/3, -1/2, 0, 1/3];
gammainc(A, 1/3)
```

```
ans =
    1.1456 + 1.9842i    0.5089 + 0.8815i    0.0000 + 0.0000i    0.7175 + 0.0000i
```

Compute the lower incomplete gamma function for the same arguments using `igamma`:

```
1 - igamma(1/3, A)/gamma(1/3)
```

```
ans =
    1.1456 + 1.9842i    0.5089 + 0.8815i    0.0000 + 0.0000i    0.7175 + 0.0000i
```

If one or both arguments are complex numbers, use `igamma` to compute the lower incomplete gamma function. `gammainc` does not accept complex arguments.

```
1 - igamma(1/2, i)/gamma(1/2)
```

```
ans =
    0.9693 + 0.4741i
```

Input Arguments

nu — Input

symbolic number | symbolic variable | symbolic expression | symbolic function | symbolic vector | symbolic matrix

Input, specified as a symbolic number, variable, expression, or function, or as a vector or matrix of symbolic numbers, variables, expressions, or functions.

z — Input

symbolic number | symbolic variable | symbolic expression | symbolic function | symbolic vector | symbolic matrix

Input, specified as a symbolic number, variable, expression, or function, or as a vector or matrix of symbolic numbers, variables, expressions, or functions.

More About

Upper Incomplete Gamma Function

The following integral defines the upper incomplete gamma function:

$$\Gamma(\eta, z) = \int_z^{\infty} t^{\eta-1} e^{-t} dt$$

Lower Incomplete Gamma Function

The following integral defines the lower incomplete gamma function:

$$\gamma(\eta, z) = \int_0^z t^{\eta-1} e^{-t} dt$$

Tips

- The MATLAB `gammainc` function does not accept complex arguments. For complex arguments, use `igamma`.
- $\text{gammainc}(z, \text{nu}) = 1 - \text{igamma}(\text{nu}, z)/\text{gamma}(\text{nu})$ represents the lower incomplete gamma function in terms of the upper incomplete gamma function.
- $\text{igamma}(\text{nu}, z) = \text{gamma}(\text{nu})(1 - \text{gammainc}(z, \text{nu}))$ represents the upper incomplete gamma function in terms of the lower incomplete gamma function.
- $\text{gammainc}(z, \text{nu}, \text{'upper'}) = \text{igamma}(\text{nu}, z)/\text{gamma}(\text{nu})$.

See Also

`ei` | `erfc` | `factorial` | `gamma` | `gammainc` | `int`

Introduced in R2014a

ihtrans

Inverse Hilbert transform

Syntax

```
f = ihtrans(H)
f = ihtrans(H,transVar)
f = ihtrans(H,var,transVar)
```

Description

`f = ihtrans(H)` returns the inverse Hilbert transform of symbolic function `H`. By default, the independent variable is `x` and the transformation variable is `t`.

`f = ihtrans(H,transVar)` uses the transformation variable `transVar` instead of `t`.

`f = ihtrans(H,var,transVar)` uses the independent variable `var` and the transformation variable `transVar` instead of `x` and `t`, respectively.

- If all input arguments are arrays of the same size, then `ihtrans` acts element-wise.
- If one input is a scalar and the others are arrays of the same size, then `ihtrans` expands the scalar into an array of the same size.
- If `f` is an array of symbolic expressions with different independent variables, then `var` must be a symbolic array with elements corresponding to the independent variables.

Examples

Inverse Hilbert Transform of Symbolic Expression

Compute the inverse Hilbert transform of $\cos(x)$. By default, the inverse transform returns a function of `t`.

```
syms x;
f = cos(x);
H = ihtrans(f)

H = -sin(t)
```

Inverse Hilbert Transform of Sinc Function

Compute the inverse Hilbert transform of the `sinc` function, which is equal to $\sin(\pi t)/\pi t$. Express the result as a function of `s`.

```
syms H(t) f(s);
H(t) = sinc(t);
f(s) = ihtrans(H,s)
```

$$f(s) = \frac{\frac{\cos(\pi s)}{s} - \frac{1}{s}}{\pi}$$

Plot the sinc function and its inverse Hilbert transform.

```
fplot(H(t),[0 6],'b')
hold on
fplot(f(s),[0 6],'r')
legend('sinc(t)','f(s)')
```

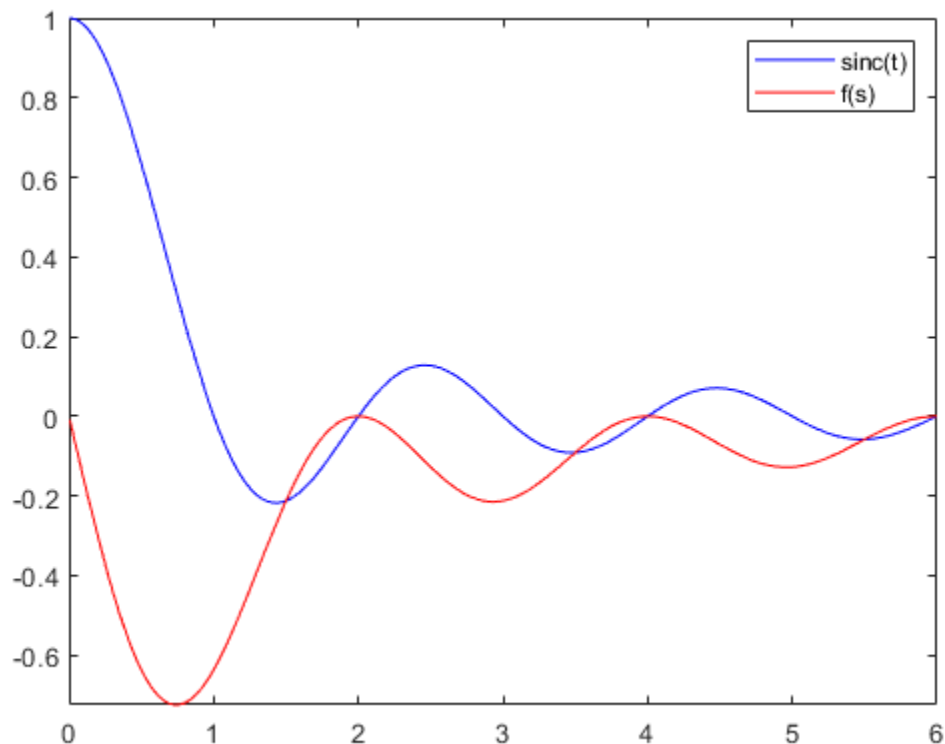

Apply Phase Shifts

Create a sine wave with a positive frequency in real space.

```
syms A x t u;
assume([x t],'real')
H = A*sin(2*pi*10*t + 5*x)
```

$$H = A \sin(5x + 20\pi t)$$

Apply a 90-degree phase shift to the positive frequency component using the inverse Hilbert transform. Specify the independent variable as x and the transformation variable as u , respectively.

```
f = ihtrans(H,x,u)
```

$$f = A \cos(5u + 20\pi t)$$

Now create a complex signal with negative frequency. Apply a -90-degree phase shift to the negative frequency component using the inverse Hilbert transform.

$$Z = A \exp(-1i \cdot 10 \cdot t)$$

$$Z = A e^{-10ti}$$

$$f = \text{ihtrans}(Z)$$

$$f = -A e^{-10ui} i$$

Calculate Instantaneous Frequency

Create a real-valued signal $f(s)$ with two frequency components, 60 Hz and 90 Hz.

```
syms s f(x) F(t)
f(s) = sin(2*pi*60*s) + sin(2*pi*90*s)
```

$$f(s) = \sin(120\pi s) + \sin(180\pi s)$$

Calculate the corresponding analytic signal $F(t)$ using the inverse Hilbert transform.

$$F(t) = \text{ihtrans}(f(s), t) + 1i \cdot f(t)$$

$$F(t) = \cos(120\pi t) + \cos(180\pi t) + \sin(120\pi t) i + \sin(180\pi t) i$$

Calculate the instantaneous frequency of $F(t)$ using

$$f_{\text{instant}}(t) = \frac{1}{2\pi} \frac{d\phi(t)}{dt},$$

where $\phi(t) = \arg[F(t)]$ is the instantaneous phase of the analytic signal.

```
InstantFreq(t) = diff(angle(F(t)), t)/(2*pi);
assume(t, 'real')
simplify(InstantFreq(t))
```

$$\text{ans} = 75$$

Input Arguments

H — Input

symbolic expression | symbolic function | symbolic vector | symbolic matrix

Input, specified as a symbolic expression, symbolic function, symbolic vector, or symbolic matrix.

var — Independent variable

x (default) | symbolic variable | symbolic vector | symbolic matrix

Independent variable, specified as a symbolic variable, symbolic vector, or symbolic matrix. This variable is usually in the time domain. If you do not specify the variable, then `ihtrans` uses `x` by

default. If H does not contain x , then `ihtrans` uses the function `symvar` to determine the independent variable.

transVar — Transformation variable

`t` (default) | `u` | symbolic variable | symbolic vector | symbolic matrix

Transformation variable, specified as a symbolic variable, symbolic vector, or symbolic matrix. This variable is in the same domain as `var`. If you do not specify the variable, then `ihtrans` uses `t` by default. If `t` is the independent variable of H , then `ihtrans` uses the transformation variable `u`.

Output Arguments

f — Inverse Hilbert transform of H

symbolic expression | symbolic function | symbolic vector | symbolic matrix

Inverse Hilbert transform of the input function H . The output `f` is a function of the variable specified by `transVar`.

When `ihtrans` cannot transform the input function, it returns an unevaluated call. To return the original expression, apply the Hilbert transform to the output by using `httrans`.

More About

Inverse Hilbert Transform

The inverse Hilbert transform $f = f(t)$ of the expression $H = H(x)$ with respect to the variable x at point t is

$$f(t) = \frac{1}{\pi} \text{p.v.} \int_{-\infty}^{\infty} \frac{H(x)}{x-t} dx.$$

Here, p.v. represents the Cauchy principal value of the integral. The function $H(x)$ can be complex, but x and t must be real.

Tips

- To compute the Hilbert transform, use `httrans`. The inverse Hilbert transform of a function is equal to the negative of its Hilbert transform.
- For a signal in the time domain, the inverse Hilbert transform applies a 90-degree phase shift to negative frequencies of the corresponding Fourier components. It also applies a -90-degree phase shift to positive frequencies.
- A real-valued signal `b` is the harmonic conjugate of its inverse Hilbert transform `a = ihtrans(b)`. The inverse Hilbert transform `a = real(z)` and the signal `b = imag(z)` form the analytic signal $z = a + 1i*b$.

See Also

`fourier` | `htrans` | `ifourier` | `ilaplace` | `laplace`

Introduced in R2019a

ilaplace

Inverse Laplace transform

Syntax

```
ilaplace(F)
ilaplace(F,transVar)
ilaplace(F,var,transVar)
```

Description

`ilaplace(F)` returns the “Inverse Laplace Transform” on page 4-741 of F. By default, the independent variable is `s` and the transformation variable is `t`. If F does not contain `s`, `ilaplace` uses the function `symvar`.

`ilaplace(F,transVar)` uses the transformation variable `transVar` instead of `t`.

`ilaplace(F,var,transVar)` uses the independent variable `var` and the transformation variable `transVar` instead of `s` and `t`, respectively.

Examples

Inverse Laplace Transform of Symbolic Expression

Compute the inverse Laplace transform of $1/s^2$. By default, the inverse transform is in terms of `t`.

```
syms s
F = 1/s^2;
ilaplace(F)

ans =
t
```

Default Independent Variable and Transformation Variable

Compute the inverse Laplace transform of $1/(s-a)^2$. By default, the independent and transformation variables are `s` and `t`, respectively.

```
syms a s
F = 1/(s-a)^2;
ilaplace(F)

ans =
t*exp(a*t)
```

Specify the transformation variable as `x`. If you specify only one variable, that variable is the transformation variable. The independent variable is still `s`.

```
syms x
ilaplace(F,x)
```

```
ans =
x*exp(a*x)
```

Specify both the independent and transformation variables as a and x in the second and third arguments, respectively.

```
ilaplace(F,a,x)
```

```
ans =
x*exp(s*x)
```

Inverse Laplace Transforms Involving Dirac and Heaviside Functions

Compute the following inverse Laplace transforms that involve the Dirac and Heaviside functions:

```
syms s t
ilaplace(1,s,t)
```

```
ans =
dirac(t)
```

```
F = exp(-2*s)/(s^2+1);
ilaplace(F,s,t)
```

```
ans =
heaviside(t - 2)*sin(t - 2)
```

Inverse Laplace Transform of Array Inputs

Find the inverse Laplace transform of the matrix M . Specify the independent and transformation variables for each matrix entry by using matrices of the same size. When the arguments are nonscalars, `ilaplace` acts on them element-wise.

```
syms a b c d w x y z
M = [exp(x) 1; sin(y) i*z];
vars = [w x; y z];
transVars = [a b; c d];
ilaplace(M,vars,transVars)
```

```
ans =
[ exp(x)*dirac(a),      dirac(b)]
[ ilaplace(sin(y), y, c), dirac(1, d)*1i]
```

If `ilaplace` is called with both scalar and nonscalar arguments, then it expands the scalars to match the nonscalars by using scalar expansion. Nonscalar arguments must be the same size.

```
syms w x y z a b c d
ilaplace(x,vars,transVars)
```

```
ans =  
[ x*dirac(a), dirac(1, b)]  
[ x*dirac(c), x*dirac(d)]
```

If Inverse Laplace Transform Cannot Be Found

If `ilaplace` cannot compute the inverse transform, then it returns an unevaluated call to `ilaplace`.

```
syms F(s) t  
F(s) = exp(s);  
f = ilaplace(F,s,t)
```

```
f =  
ilaplace(exp(s), s, t)
```

Return the original expression by using `laplace`.

```
laplace(f,t,s)
```

```
ans =  
exp(s)
```

Inverse Laplace Transform of Symbolic Function

Compute the Inverse Laplace transform of symbolic functions. When the first argument contains symbolic functions, then the second argument must be a scalar.

```
syms f1(x) f2(x) a b  
f1(x) = exp(x);  
f2(x) = x;  
ilaplace([f1 f2],x,[a b])
```

```
ans =  
[ ilaplace(exp(x), x, a), dirac(1, b)]
```

Input Arguments

F — Input

symbolic expression | symbolic function | symbolic vector | symbolic matrix

Input, specified as a symbolic expression, function, vector, or matrix.

var — Independent variable

s (default) | symbolic variable | symbolic expression | symbolic vector | symbolic matrix

Independent variable, specified as a symbolic variable, expression, vector, or matrix. This variable is often called the "complex frequency variable." If you do not specify the variable, then `ilaplace` uses `s`. If `F` does not contain `s`, then `ilaplace` uses the function `symvar` to determine the independent variable.

transVar — Transformation variable

t (default) | x | symbolic variable | symbolic expression | symbolic vector | symbolic matrix

Transformation variable, specified as a symbolic variable, expression, vector, or matrix. It is often called the "time variable" or "space variable." By default, `ilaplace` uses `t`. If `t` is the independent variable of `F`, then `ilaplace` uses `x`.

More About

Inverse Laplace Transform

The inverse Laplace transform $f = f(t)$ of $F = F(s)$ is:

$$f(t) = \frac{1}{2\pi i} \int_{c-i\infty}^{c+i\infty} F(s)e^{st} ds.$$

Here, c is a suitable complex number.

Tips

- If any argument is an array, then `ilaplace` acts element-wise on all elements of the array.
- If the first argument contains a symbolic function, then the second argument must be a scalar.
- To compute the direct Laplace transform, use `laplace`.
- For a signal $f(t)$, computing the Laplace transform (`laplace`) and then the inverse Laplace transform (`ilaplace`) of the result may not return the original signal for $t < 0$. This is because the definition of `laplace` uses the unilateral transform on page 4-879. This definition assumes that the signal $f(t)$ is only defined for all real numbers $t \geq 0$. Therefore, the inverse result does not make sense for $t < 0$ and may not match the original signal for negative t . One way to correct the problem is to multiply the result of `ilaplace` by a Heaviside step function. For example, both of these code blocks:

```
syms t;
laplace(sin(t))
```

and

```
syms t;
laplace(sin(t)*heaviside(t))
```

return $1/(s^2 + 1)$. However, the inverse Laplace transform

```
syms s;
ilaplace(1/(s^2 + 1))
```

returns $\sin(t)$, not $\sin(t)*\text{heaviside}(t)$.

See Also

`fourier` | `ifourier` | `iztrans` | `laplace` | `ztrans`

Topics

"Solve Differential Equations Using Laplace Transform" on page 2-218

Introduced before R2006a

imag

Imaginary part of complex number

Syntax

```
imag(z)
```

Description

`imag(z)` returns the imaginary part of `z`. If `z` is a matrix, `imag` acts elementwise on `z`.

Examples

Compute Imaginary Part of Numeric Inputs

Find the imaginary parts of these numbers. Because these numbers are not symbolic objects, you get floating-point results.

```
[imag(2 + 3/2*i), imag(sin(5*i)), imag(2*exp(1 + i))]  
ans =  
    1.5000    74.2032    4.5747
```

Compute Imaginary Part of Symbolic Inputs

Compute the imaginary parts of the numbers converted to symbolic objects:

```
[imag(sym(2) + 3/2*i), imag(4/(sym(1) + 3*i)), imag(sin(sym(5)*i))]  
ans =  
[ 3/2, -6/5, sinh(5)]
```

Compute the imaginary part of this symbolic expression:

```
imag(2*exp(1 + sym(i)))  
ans =  
2*exp(1)*sin(1)
```

Compute Imaginary Part of Symbolic Expressions

In general, `imag` cannot extract the entire imaginary parts from symbolic expressions containing variables. However, `imag` can rewrite and sometimes simplify the input expression:

```
syms a x y  
imag(a + 2)  
imag(x + y*i)  
ans =  
imag(a)  
ans =  
imag(x) + real(y)
```

If you assign numeric values to these variables or if you specify that these variables are real, `imag` can extract the imaginary part of the expression:

```
syms a
a = 5 + 3*i;
imag(a + 2)
```

```
ans =
     3
```

```
syms x y real
imag(x + y*i)
```

```
ans =
     y
```

Clear the assumption that `x` and `y` are real by recreating them using `syms`:

```
syms x y
```

Compute Imaginary Part for Matrix Input

Find the imaginary parts of the elements of matrix `A`:

```
syms x
A = [-1 + sym(i), sinh(x); exp(10 + sym(7)*i), exp(sym(pi)*i)];
imag(A)
```

```
ans =
 [          1, imag(sinh(x))]
 [ exp(10)*sin(7),          0]
```

Input Arguments

z — Input

number | vector | matrix | array | symbolic number | symbolic variable | symbolic array | symbolic function | symbolic expression

Input, specified as a number, vector, matrix, or array, or a symbolic number, variable, array, function, or expression.

Tips

- Calling `imag` for a number that is not a symbolic object invokes the MATLAB `imag` function.

Alternatives

You can compute the imaginary part of `z` via the conjugate: $\text{imag}(z) = (z - \text{conj}(z))/2i$.

See Also

`conj` | `in` | `real` | `sign` | `signIm`

Introduced before R2006a

in

Numeric type of symbolic input

Syntax

```
in(x, type)
```

Description

`in(x, type)` expresses the logical condition that `x` is of the specified `type`.

Examples

Express Condition on Symbolic Variable or Expression

The syntax `in(x, type)` expresses the condition that `x` is of the specified `type`. Express the condition that `x` is of type `Real`.

```
syms x
cond = in(x, 'real')
```

```
cond =
in(x, 'real')
```

Evaluate the condition using `isAlways`. Because `isAlways` cannot determine the condition, it issues a warning and returns logical `0` (`false`).

```
isAlways(cond)
```

```
Warning: Unable to prove 'in(x, 'real')'.
```

```
ans =
    logical
     0
```

Assume the condition `cond` is true using `assume`, and evaluate the condition again. The `isAlways` function returns logical `1` (`true`) indicating that the condition is true.

```
assume(cond)
isAlways(cond)
```

```
ans =
    logical
     1
```

To use `x` in further computations, clear its assumption recreating it using `syms`.

```
syms x
```

Express Conditions in Output

Functions such as `solve` use `in` in output to express conditions.

Solve the equation $\sin(x) == 0$ using `solve`. Set the option `ReturnConditions` to `true` to return conditions on the solution. The `solve` function uses `in` to express the conditions.

```
syms x
[solx, params, conds] = solve(sin(x) == 0, 'ReturnConditions', true)

solx =
pi*k

params =
k

conds =
in(k, 'integer')
```

The solution is $\pi*k$ with parameter k under the condition `in(k, 'integer')`. You can use this condition to set an assumption for further computations. Under the assumption, `solve` returns only integer values of k .

```
assume(conds)
k = solve(solx > 0, solx < 5*pi, params)

k =
1
2
3
4
```

To find the solutions corresponding to these values of k , use `subs` to substitute for k in `solx`.

```
subs(solx, k)

ans =
pi
2*pi
3*pi
4*pi
```

Clear the assumption on k to use it in further computations.

```
assume(params, 'clear')
```

Test if Elements of Symbolic Matrix Are Rational

Create symbolic matrix M .

```
syms x y z
M = sym([1.22 i x; sin(y) 3*x 0; Inf sqrt(3) sym(22/7)])

M =
[ 61/50,      1i,      x]
[ sin(y),    3*x,    0]
[      Inf, 3^(1/2), 22/7]
```

Use `isAlways` to test if the elements of M are rational numbers. The `in` function acts on M element-by-element. Note that `isAlways` returns logical `0` (`false`) for statements that cannot be decided and issues a warning for those statements.

```
in(M, 'rational')
```

```
ans =  
[ in(61/50, 'rational'),      in(1i, 'rational'),      in(x, 'rational')]  
[ in(sin(y), 'rational'),    in(3*x, 'rational'),    in(0, 'rational')]  
[ in(Inf, 'rational'), in(3^(1/2), 'rational'), in(22/7, 'rational')]
```

```
isAlways(in(M, 'rational'))
```

```
Warning: Unable to prove 'in(sin(y), 'rational')'.
```

```
Warning: Unable to prove 'in(3*x, 'rational')'.
```

```
Warning: Unable to prove 'in(x, 'rational')'.
```

```
ans =  
 3×3 logical array  
 1  0  0  
 0  0  1  
 0  0  1
```

Input Arguments

x — Input

symbolic number | symbolic vector | symbolic matrix | symbolic multidimensional array | symbolic expression | symbolic function

Input, specified as a symbolic number, vector, matrix, multidimensional array, expression, or function.

type — Type of input

'real' | 'positive' | 'integer' | 'rational'

Type of input, specified as 'real', 'positive', 'integer', or 'rational'.

See Also

assume | assumeAlso | false | imag | isalways | isequal | isequaln | isfinite | isinf | piecewise | real | true

Introduced in R2014b

incidenceMatrix

Find incidence matrix of system of equations

Syntax

```
A = incidenceMatrix(eqs,vars)
```

Description

`A = incidenceMatrix(eqs,vars)` for m equations `eqs` and n variables `vars` returns an m -by- n matrix `A`. Here, $A(i,j) = 1$ if `eqs(i)` contains `vars(j)` or any derivative of `vars(j)`. All other elements of `A` are 0s.

Examples

Incidence Matrix

Find the incidence matrix of a system of five equations in five variables.

Create the following symbolic vector `eqs` containing five symbolic differential equations.

```
syms y1(t) y2(t) y3(t) y4(t) y5(t) c1 c3
eqs = [diff(y1(t),t) == y2(t),...
       diff(y2(t),t) == c1*y1(t) + c3*y3(t),...
       diff(y3(t),t) == y2(t) + y4(t),...
       diff(y4(t),t) == y3(t) + y5(t),...
       diff(y5(t),t) == y4(t)];
```

Create the vector of variables. Here, `c1` and `c3` are symbolic parameters (not variables) of the system.

```
vars = [y1(t), y2(t), y3(t), y4(t), y5(t)];
```

Find the incidence matrix `A` for the equations `eqs` and with respect to the variables `vars`.

```
A = incidenceMatrix(eqs, vars)
```

```
A =
     1     1     0     0     0
     1     1     1     0     0
     0     1     1     1     0
     0     0     1     1     1
     0     0     0     1     1
```

Input Arguments

eqs — Equations

vector of symbolic equations | vector of symbolic expressions

Equations, specified as a vector of symbolic equations or expressions.

vars – Variables

vector of symbolic variables | vector of symbolic functions | vector of symbolic function calls

Variables, specified as a vector of symbolic variables, symbolic functions, or function calls, such as $x(t)$.

Output Arguments**A – Incidence matrix**

matrix of double-precision values

Incidence matrix, returned as a matrix of double-precision values.

See Also

`daeFunction` | `decic` | `findDecoupledBlocks` | `isLowIndexDAE` | `massMatrixForm` | `odeFunction` | `reduceDAEIndex` | `reduceDAEToODE` | `reduceDifferentialOrder` | `reduceRedundancies` | `spy`

Introduced in R2014b

int

Definite and indefinite integrals

Syntax

```
F = int(expr)
F = int(expr, var)

F = int(expr, a, b)
F = int(expr, var, a, b)

F = int( ____, Name, Value)
```

Description

`F = int(expr)` computes the indefinite integral of `expr`. `int` uses the default integration variable determined by `symvar(expr, 1)`. If `expr` is a constant, then the default integration variable is `x`.

`F = int(expr, var)` computes the indefinite integral of `expr` with respect to the symbolic scalar variable `var`.

`F = int(expr, a, b)` computes the definite integral of `expr` from `a` to `b`. `int` uses the default integration variable determined by `symvar(expr, 1)`. If `expr` is a constant, then the default integration variable is `x`.

`int(expr, [a b])` is equivalent to `int(expr, a, b)`.

`F = int(expr, var, a, b)` computes the definite integral of `expr` with respect to the symbolic scalar variable `var` from `a` to `b`.

`int(expr, var, [a b])` is equivalent to `int(expr, var, a, b)`.

`F = int(____, Name, Value)` specifies additional options using one or more `Name, Value` pair arguments. For example, `'IgnoreAnalyticConstraints', true` specifies that `int` applies additional simplifications to the integrand.

Examples

Indefinite Integral of Univariate Expression

Define a univariate expression.

```
syms x
expr = -2*x/(1+x^2)^2;
```

Find the indefinite integral of the univariate expression.

```
F = int(expr)
F =
```

$$\frac{1}{x^2 + 1}$$

Indefinite Integrals of Multivariate Function

Define a multivariate function with variables x and z .

```
syms x z
f(x,z) = x/(1+z^2);
```

Find the indefinite integrals of the multivariate expression with respect to the variables x and z .

```
Fx = int(f,x)
```

$$F_x(x, z) = \frac{x^2}{2(z^2 + 1)}$$

```
Fz = int(f,z)
```

$$F_z(x, z) = x \operatorname{atan}(z)$$

If you do not specify the integration variable, then `int` uses the first variable returned by `symvar` as the integration variable.

```
var = symvar(f,1)
```

```
var = x
```

```
F = int(f)
```

$$F(x, z) = \frac{x^2}{2(z^2 + 1)}$$

Definite Integrals of Symbolic Expressions

Integrate a symbolic expression from 0 to 1.

```
syms x
expr = x*log(1+x);
F = int(expr,[0 1])
```

$$F = \frac{1}{4}$$

Integrate another expression from $\sin(t)$ to 1.

```
syms t
F = int(2*x,[sin(t) 1])
```

$$F = \cos(t)^2$$

When `int` cannot compute the value of a definite integral, numerically approximate the integral by using `vpa`.

```
syms x
f = cos(x)/sqrt(1 + x^2);
Fint = int(f,x,[0 10])
```

```
Fint =

$$\int_0^{10} \frac{\cos(x)}{\sqrt{x^2 + 1}} dx$$

```

```
Fvpa = vpa(Fint)
```

```
Fvpa = 0.37570628299079723478493405557162
```

To approximate integrals directly, use `vpaintegral` instead of `vpa`. The `vpaintegral` function is faster and provides control over integration tolerances.

```
Fvpaint = vpaintegral(f,x,[0 10])
```

```
Fvpaint = 0.375706
```

Integrals of Matrix Elements

Define a symbolic matrix containing four expressions as its elements.

```
syms a x t z
M = [exp(t) exp(a*t); sin(t) cos(t)]
```

```
M =

$$\begin{pmatrix} e^t & e^{at} \\ \sin(t) & \cos(t) \end{pmatrix}$$

```

Find indefinite integrals of the matrix element-wise.

```
F = int(M,t)
```

```
F =

$$\begin{pmatrix} e^t & \frac{e^{at}}{a} \\ -\cos(t) & \sin(t) \end{pmatrix}$$

```

Apply IgnoreAnalyticConstraints

Define a symbolic function and compute its indefinite integral.

```
syms f(x)
f(x) = acos(cos(x));
F = int(f,x)
```

```
F(x) =

$$x \operatorname{acos}(\cos(x)) - \frac{x^2}{2 \operatorname{sign}(\sin(x))}$$

```

By default, `int` uses strict mathematical rules. These rules do not let `int` rewrite `acos(cos(x))` as `x`.

If you want a simple practical solution, set `'IgnoreAnalyticConstraints'` to `true`.

```
F = int(f,x,'IgnoreAnalyticConstraints',true)
```

$$F(x) = \frac{x^2}{2}$$

Ignore Special Cases

Define a symbolic expression x^t and compute its indefinite integral with respect to the variable x .

```
syms x t
F = int(x^t,x)
```

$$F = \begin{cases} \log(x) & \text{if } t = -1 \\ \frac{x^{t+1}}{t+1} & \text{if } t \neq -1 \end{cases}$$

By default, `int` returns the general results for all values of the other symbolic parameter t . In this example, `int` returns two integral results for the case $t = -1$ and $t \neq -1$.

To ignore special cases of parameter values, set `'IgnoreSpecialCases'` to `true`. With this option, `int` ignores the special case $t = -1$ and returns the solution for $t \neq -1$.

```
F = int(x^t,x,'IgnoreSpecialCases',true)
```

$$F = \frac{x^{t+1}}{t+1}$$

Find Cauchy Principal Value

Define a symbolic function $f(x) = 1/(x-1)$ that has a pole at $x = 1$.

```
syms x
f(x) = 1/(x-1)
```

$$f(x) = \frac{1}{x-1}$$

Compute the definite integral of this function from $x = 0$ to $x = 2$. Since the integration interval includes the pole, the result is not defined.

```
F = int(f,[0 2])
```

```
F = NaN
```

However, the Cauchy principal value of the integral exists. To compute the Cauchy principal value of the integral, set 'PrincipalValue' to true.

```
F = int(f,[0 2], 'PrincipalValue', true)
```

```
F = 0
```

Unevaluated Integral and Integration by Parts

Find the integral of $\int x e^x dx$.

Define the integral without evaluating it by setting the 'Hold' option to true.

```
syms x g(y)
F = int(x*exp(x), 'Hold', true)
```

```
F =
```

$$\int x e^x dx$$

You can apply integration by parts to F by using the `integrateByParts` function. Use `exp(x)` as the differential to be integrated.

```
G = integrateByParts(F, exp(x))
```

```
G =
```

$$x e^x - \int e^x dx$$

To evaluate the integral in G, use the `release` function to ignore the 'Hold' option.

```
Gcalc = release(G)
```

```
Gcalc = x e^x - e^x
```

Compare the result to the integration result returned by `int` without setting the 'Hold' option.

```
Fcalc = int(x*exp(x))
```

```
Fcalc = e^x (x - 1)
```

Approximate Indefinite Integrals

If `int` cannot compute a closed form of an integral, then it returns an unresolved integral.

```
syms f(x)
f(x) = sin(sinh(x));
F = int(f,x)
```

```
F(x) =
```

$$\int \sin(\sinh(x)) dx$$

You can approximate the integrand function $f(x)$ as polynomials by using the Taylor expansion. Apply `taylor` to expand the integrand function $f(x)$ as polynomials around $x = 0$. Compute the integral of the approximated polynomials.

```
fTaylor = taylor(f,x,'ExpansionPoint',0,'Order',10)
```

$$fTaylor(x) = \frac{x^9}{5670} - \frac{x^7}{90} - \frac{x^5}{15} + x$$

```
Fapprox = int(fTaylor,x)
```

$$Fapprox(x) = \frac{x^{10}}{56700} - \frac{x^8}{720} - \frac{x^6}{90} + \frac{x^2}{2}$$

Input Arguments

expr — Integrand

symbolic expression | symbolic function | symbolic vector | symbolic matrix | symbolic number

Integrand, specified as a symbolic expression, function, vector, matrix, or number.

var — Integration variable

symbolic variable

Integration variable, specified as a symbolic variable. If you do not specify this variable, `int` uses the default variable determined by `symvar(expr,1)`. If `expr` is a constant, then the default variable is `x`.

a — Lower bound

number | symbolic number | symbolic variable | symbolic expression | symbolic function

Lower bound, specified as a number, symbolic number, variable, expression, or function (including expressions and functions with infinities).

b — Upper bound

number | symbolic number | symbolic variable | symbolic expression | symbolic function

Upper bound, specified as a number, symbolic number, variable, expression, or function (including expressions and functions with infinities).

Name-Value Pair Arguments

Specify optional comma-separated pairs of `Name`, `Value` arguments. `Name` is the argument name and `Value` is the corresponding value. `Name` must appear inside quotes. You can specify several name and value pair arguments in any order as `Name1, Value1, ..., NameN, ValueN`.

Example: `'IgnoreAnalyticConstraints', true` specifies that `int` applies purely algebraic simplifications to the integrand.

IgnoreAnalyticConstraints — Indicator for applying purely algebraic simplifications to integrand

false (default) | true

Indicator for applying purely algebraic simplifications to the integrand, specified as `true` or `false`. If the value is `true`, apply purely algebraic simplifications to the integrand. This option can provide simpler results for expressions, for which the direct use of the integrator returns complicated results. Sometimes, it also enables `int` to compute integrals that cannot be computed otherwise.

Using this option can lead to wrong or incomplete results.

IgnoreSpecialCases — Indicator for ignoring special cases

`false` (default) | `true`

Indicator for ignoring special cases, specified as `true` or `false`. This ignores cases that require one or more parameters to be elements of a comparatively small set, such as a fixed finite set or a set of integers.

PrincipalValue — Indicator for returning principal value

`false` (default) | `true`

Indicator for returning the principal value, specified as `true` or `false`. If the value is `true`, compute the Cauchy principal value of the integral.

Hold — Indicator for unevaluated integration

`false` (default) | `true`

Indicator for unevaluated integration, specified as `true` or `false`. If the value is `true`, `int` returns integrals without evaluating them.

Tips

- In contrast to differentiation, symbolic integration is a more complicated task. If `int` cannot compute an integral of an expression, check for these reasons:
 - The antiderivative does not exist in a closed form.
 - The antiderivative exists, but `int` cannot find it.

If `int` cannot compute a closed form of an integral, it returns an unresolved integral.

Try approximating such integrals by using one of these methods:

- For indefinite integrals, use series expansions. Use this method to approximate an integral around a particular value of the variable.
- For definite integrals, use numeric approximations.
- For indefinite integrals, `int` does not return a constant of integration in the result. The results of integrating mathematically equivalent expressions may be different. For example, `syms x; int((x+1)^2)` returns $(x+1)^3/3$, while `syms x; int(x^2+2*x+1)` returns $(x*(x^2+3*x+3))/3$, which differs from the first result by $1/3$.
- For indefinite integrals, `int` implicitly assumes that the integration variable `var` is real. For definite integrals, `int` restricts the integration variable `var` to the specified integration interval. If one or both integration bounds `a` and `b` are not numeric, `int` assumes that `a <= b` unless you explicitly specify otherwise.

Algorithms

When you use `IgnoreAnalyticConstraints`, `int` applies these rules:

- $\log(a) + \log(b) = \log(a \cdot b)$ for all values of a and b . In particular, the following equality is valid for all values of a , b , and c :

$$(a \cdot b)^c = a^c \cdot b^c.$$

- $\log(a^b) = b \cdot \log(a)$ for all values of a and b . In particular, the following equality is valid for all values of a , b , and c :

$$(a^b)^c = a^{b \cdot c}.$$

- If f and g are standard mathematical functions and $f(g(x)) = x$ for all small positive numbers, then $f(g(x)) = x$ is assumed to be valid for all complex values x . In particular:

- $\log(e^x) = x$
- $\text{asin}(\sin(x)) = x$, $\text{acos}(\cos(x)) = x$, $\text{atan}(\tan(x)) = x$
- $\text{asinh}(\sinh(x)) = x$, $\text{acosh}(\cosh(x)) = x$, $\text{atanh}(\tanh(x)) = x$
- $W_k(x \cdot e^x) = x$ for all branch indices k of the Lambert W function.

See Also

`changeIntegrationVariable` | `diff` | `dsolve` | `functionalDerivative` | `integrateByParts`
| `release` | `symvar` | `vpaintegral`

Topics

"Integration" on page 2-59

Introduced before R2006a

integrateByParts

Integration by parts

Syntax

```
G = integrateByParts(F,du)
```

Description

`G = integrateByParts(F,du)` applies integration by parts to the integrals in `F`, in which the differential `du` is integrated. For more information, see “Integration by Parts” on page 4-759.

When specifying the integrals in `F`, you can return the unevaluated form of the integrals by using the `int` function with the 'Hold' option set to true. You can then use `integrateByParts` to show the steps of integration by parts.

Examples

Product of Functions

Create a symbolic expression `F` that is the integral of a product of functions.

```
syms u(x) v(x)
F = int(u*diff(v))
```

$$F(x) = \int u(x) \frac{\partial}{\partial x} v(x) dx$$

Apply integration by parts to `F`.

```
g = integrateByParts(F,diff(u))
```

$$g = u(x) v(x) - \int v(x) \frac{\partial}{\partial x} u(x) dx$$

Exponential Function

Apply integration by parts to the integral $\int x^2 e^x dx$.

Define the integral using the `int` function. Show the result without evaluating the integral by setting the 'Hold' option to true.

```
syms x
F = int(x^2*exp(x),'Hold',true)
```

```
F =
```

$$\int x^2 e^x dx$$

To show the steps of integration, apply integration by parts to F and use $\exp(x)$ as the differential to be integrated.

$$G = \text{integrateByParts}(F, \exp(x))$$

$$G = x^2 e^x - \int 2x e^x dx$$

$$H = \text{integrateByParts}(G, \exp(x))$$

$$H = x^2 e^x - 2x e^x + \int 2 e^x dx$$

Evaluate the integral in H by using the release function to ignore the 'Hold' option.

$$F1 = \text{release}(H)$$

$$F1 = 2 e^x + x^2 e^x - 2x e^x$$

Compare the result to the integration result returned by the `int` function without setting the 'Hold' option to `true`.

$$F2 = \text{int}(x^2 * \exp(x))$$

$$F2 = e^x (x^2 - 2x + 2)$$

Exponential and Trigonometric Functions

Apply integration by parts to the integral $\int e^{ax} \sin(bx) dx$.

Define the integral using the `int` function. Show the integral without evaluating it by setting the 'Hold' option to `true`.

$$\text{syms } x \ a \ b$$

$$F = \text{int}(\exp(a*x) * \sin(b*x), 'Hold', true)$$

$$F = \int e^{ax} \sin(bx) dx$$

To show the steps of integration, apply integration by parts to F and use $u'(x) = e^{ax}$ as the differential to be integrated.

$$G = \text{integrateByParts}(F, \exp(a*x))$$

$$G = \frac{e^{ax} \sin(bx)}{a} - \int \frac{b e^{ax} \cos(bx)}{a} dx$$

Evaluate the integral in G by using the release function to ignore the 'Hold' option.

F1 = `release(G)`

$$F1 = \frac{e^{ax} \sin(bx)}{a} - \frac{b e^{ax} (a \cos(bx) + b \sin(bx))}{a(a^2 + b^2)}$$

Simplify the result.

F2 = `simplify(F1)`

$$F2 = -\frac{e^{ax} (b \cos(bx) - a \sin(bx))}{a^2 + b^2}$$

Input Arguments

F — Expression containing integrals

symbolic expression | symbolic function | symbolic vector | symbolic matrix

Expression containing integrals, specified as a symbolic expression, function, vector, or matrix.

Example: `int(u*diff(v))`

du — Differential to be integrated

symbolic variable | symbolic expression | symbolic function

Differential to be integrated, specified as a symbolic variable, expression, or function.

Example: `diff(u)`

More About

Integration by Parts

Mathematically, the rule of integration by parts is formally defined for indefinite integrals as

$$\int u'(x) v(x) dx = u(x) v(x) - \int u(x) v'(x) dx$$

and for definite integrals as

$$\int_a^b u'(x) v(x) dx = u(b) v(b) - u(a) v(a) - \int_a^b u(x) v'(x) dx.$$

See Also

`changeIntegrationVariable` | `diff` | `int` | `release` | `vpaintegral`

Introduced in R2019b

inv

Inverse of symbolic matrix

Syntax

```
inv(A)
```

Description

inv(A) returns the inverse of the symbolic matrix A.

Examples

Compute Inverse of Symbolic Matrix

Compute the inverse of the following matrix of symbolic numbers.

```
A = sym([2 -1 0; -1 2 -1; 0 -1 2]);  
inv(A)
```

```
ans =  
[ 3/4, 1/2, 1/4]  
[ 1/2, 1, 1/2]  
[ 1/4, 1/2, 3/4]
```

Compute the inverse of the following symbolic matrix.

```
syms a b c d  
A = [a b; c d];  
inv(A)
```

```
ans =  
[ d/(a*d - b*c), -b/(a*d - b*c)]  
[ -c/(a*d - b*c), a/(a*d - b*c)]
```

Compute Inverse of Symbolic Hilbert Matrix

Compute the inverse of the symbolic Hilbert matrix.

```
inv(sym(hilb(4)))
```

```
ans =  
[ 16, -120, 240, -140]  
[ -120, 1200, -2700, 1680]  
[ 240, -2700, 6480, -4200]  
[ -140, 1680, -4200, 2800]
```

Input Arguments

A — Matrix

symbolic matrix

Matrix, specified as a symbolic matrix.

Limitations

Matrix computations involving many symbolic variables can be slow. To increase the computational speed, reduce the number of symbolic variables by substituting the given values for some variables.

See Also

det | eig | rank

Introduced before R2006a

isAlways

Check whether equation or inequality holds for all values of its variables

Note `isAlways` issues a warning when returning false for undecidable inputs. To suppress the warning, set the `Unknown` option to `false` as `isAlways(cond, 'Unknown', 'false')`. For details, see “Handle Output for Undecidable Conditions”.

Syntax

```
isAlways(cond)
isAlways(cond, Name, Value)
```

Description

`isAlways(cond)` checks if the condition `cond` is valid for all possible values of the symbolic variables in `cond`. When verifying `cond`, the `isAlways` function considers all assumptions on the variables in `cond`. If the condition holds, `isAlways` returns logical 1 (`true`). Otherwise it returns logical 0 (`false`).

`isAlways(cond, Name, Value)` uses additional options specified by one or more `Name, Value` pair arguments.

Examples

Test Conditions

Check if this inequality is valid for all values of x .

```
syms x
isAlways(abs(x) >= 0)
```

```
ans =
    logical
     1
```

`isAlways` returns logical 1 (`true`) indicating that the inequality $\text{abs}(x) \geq 0$ is valid for all values of x .

Check if this equation is valid for all values of x .

```
isAlways(sin(x)^2 + cos(x)^2 == 1)
```

```
ans =
    logical
     1
```

`isAlways` returns logical 1 (`true`) indicating that the equation is valid for all values of x .

Test if One of Several Conditions Is Valid

Check if at least one of these two conditions is valid. To check if at least one of several conditions is valid, combine them using the logical operator `or` or its shortcut `|`.

```
syms x
isAlways(sin(x)^2 + cos(x)^2 == 1 | x^2 > 0)

ans =
    logical
     1
```

Check if both conditions are valid. To check if several conditions are valid, combine them using the logical operator `and` or its shortcut `&`.

```
isAlways(sin(x)^2 + cos(x)^2 == 1 & abs(x) > 2*abs(x))

ans =
    logical
     0
```

Handle Output for Undecidable Conditions

Test this condition. When `isAlways` cannot determine if the condition is valid, it returns logical 0 (`false`) and issues a warning by default.

```
syms x
isAlways(2*x >= x)

Warning: Unable to prove 'x <= 2*x'.
ans =
    logical
     0
```

To change this default behavior, use `Unknown`. For example, specify `Unknown` as `false` to suppress the warning and make `isAlways` return logical 0 (`false`) if it cannot determine the validity of the condition.

```
isAlways(2*x >= x, 'Unknown', 'false')

ans =
    logical
     0
```

Instead of `false`, you can also specify `error` to return an error, and `true` to return logical 1 (`true`).

Test Conditions with Assumptions

Check this inequality under the assumption that x is negative. When `isAlways` tests an equation or inequality, it takes into account assumptions on variables in that equation or inequality.

```
syms x
assume(x < 0)
isAlways(2*x < x)

ans =
    logical
     1
```

For further computations, clear the assumption on x by recreating it using `syms`.

```
syms x
```

Input Arguments

cond — Condition to check

symbolic condition | vector of symbolic conditions | matrix of symbolic conditions | multidimensional array of symbolic conditions

Condition to check, specified as a symbolic condition, or a vector, matrix, or multidimensional array of symbolic conditions.

Name-Value Pair Arguments

Specify optional comma-separated pairs of `Name`, `Value` arguments. `Name` is the argument name and `Value` is the corresponding value. `Name` must appear inside quotes. You can specify several name and value pair arguments in any order as `Name1, Value1, ..., NameN, ValueN`.

Example: `isAlways(cond, 'Unknown', true)` makes `isAlways` return logical 1 (`true`) when the specified condition cannot be decided.

Unknown — Return value for undecidable condition

`falseWithWarning` (default) | `false` | `true` | `error`

Return value for an undecidable condition, specified as the comma-separated pair of 'Unknown' and one of these values.

<code>falseWithWarning</code> (default)	On undecidable inputs, return logical 0 (<code>false</code>) and a warning that the condition cannot be proven.
<code>false</code>	On undecidable inputs, return logical 0 (<code>false</code>).
<code>true</code>	On undecidable inputs, return logical 1 (<code>true</code>).
<code>error</code>	On undecidable inputs, return an error.

See Also

`assume` | `assumeAlso` | `assumptions` | `in` | `isequal` | `isequaln` | `isfinite` | `isinf` | `isnan` | `piecewise` | `sym` | `syms`

Topics

“Use Assumptions on Symbolic Variables” on page 1-24

“Clear Assumptions and Reset the Symbolic Engine” on page 2-112

Introduced in R2012a

isequal

Test equality of symbolic inputs

Syntax

```
isequal(a,b)
isequal(a1,a2,...,aN)
```

Description

`isequal(a,b)` returns logical 1 (true) if A and B are the same size and their contents are of equal value. Otherwise, `isequal` returns logical 0 (false). `isequal` does not consider NaN (not a number) values equal. `isequal` recursively compares the contents of symbolic data structures and the properties of objects. If all contents in the respective locations are equal, `isequal` returns logical 1 (true).

`isequal(a1,a2,...,aN)` returns logical 1 (true) if all the inputs `a1,a2,...,aN` are equal.

Examples

Test Numbers for Equality

Test numeric or symbolic inputs for equality using `isequal`. If you compare numeric inputs against symbolic inputs, `isequal` returns 0 (false) because double and symbolic are distinct data types.

Test if 2 and 5 are equal. Because you are comparing doubles, the MATLAB `isequal` function is called. `isequal` returns 0 (false) as expected.

```
isequal(2,5)
```

```
ans =
    logical
     0
```

Test if the solution of the equation $\cos(x) == -1$ is π . The `isequal` function returns 1 (true) meaning the solution is equal to π .

```
syms x
sol = solve(cos(x) == -1, x);
isequal(sol,sym(pi))
```

```
ans =
    logical
     1
```

Compare the double and symbolic representations of 1. `isequal` returns 0 (false) because double and symbolic are distinct data types. To return 1 (true) in this case, use `logical` instead.

```
usingIsEqual = isequal(pi,sym(pi))
usingLogical = logical(pi == sym(pi))
```

```
usingIsEqual =
    logical
```

```

0
usingLogical =
    logical
    1

```

Test Symbolic Expressions for Equality

Test if `rewrite` correctly rewrites $\tan(x)$ as $\sin(x)/\cos(x)$. The `isequal` function returns 1 (`true`) meaning the rewritten result equals the test expression.

```

syms x
f = rewrite(tan(x), 'sincos');
testf = sin(x)/cos(x);
isequal(f, testf)

```

```

ans =
    logical
    1

```

Test Symbolic Vectors and Matrices for Equality

Test vectors and matrices for equality using `isequal`.

Test if solutions of the quadratic equation found by `solve` are equal to the expected solutions. `isequal` function returns 1 (`true`) meaning the inputs are equal.

```

syms a b c x
eqn = a*x^2 + b*x + c;
Sol = solve(eqn, x);
testSol = [-(b+(b^2-4*a*c)^(1/2))/(2*a); -(b-(b^2-4*a*c)^(1/2))/(2*a)];
isequal(Sol, testSol)

```

```

ans =
    logical
    1

```

The Hilbert matrix is a special matrix that is difficult to invert accurately. If the inverse is accurately computed, then multiplying the inverse by the original Hilbert matrix returns the identity matrix.

Use this condition to symbolically test if the inverse of `hilb(20)` is correctly calculated. `isequal` returns 1 (`true`) meaning that the product of the inverse and the original Hilbert matrix is equal to the identity matrix.

```

H = sym(hilb(20));
prod = H*inv(H);
eye20 = sym(eye(20));
isequal(prod, eye20)

```

```

ans =
    logical
    1

```

Compare Inputs Containing NaN

Compare three vectors containing NaN (not a number). `isequal` returns logical 0 (`false`) because `isequal` does not treat NaN values as equal to each other.

```

syms x
A1 = [x NaN NaN];

```

```
A2 = [x NaN NaN];  
A3 = [x NaN NaN];  
isequal(A1, A2, A3)
```

```
ans =  
    logical  
     0
```

Input Arguments

a, b — Inputs to compare

numbers | vectors | matrices | multidimensional arrays | symbolic numbers | symbolic variables | symbolic vectors | symbolic matrices | symbolic multidimensional arrays | symbolic functions | symbolic expressions

Inputs to compare, specified as numbers, vectors, matrices, or multidimensional arrays or symbolic numbers, variables, vectors, matrices, multidimensional arrays, functions, or expressions.

a1, a2, . . . , aN — Several inputs to compare

numbers | vectors | matrices | multidimensional arrays | symbolic numbers | symbolic variables | symbolic vectors | symbolic matrices | symbolic multidimensional arrays | symbolic functions | symbolic expressions

Several inputs to compare, specified as numbers, vectors, matrices, or multidimensional arrays or symbolic numbers, variables, vectors, matrices, multidimensional arrays, functions, or expressions.

Tips

- When your inputs are not symbolic objects, the MATLAB `isequal` function is called. If one of the arguments is symbolic, then all other arguments are converted to symbolic objects before comparison, and the symbolic `isequal` function is called.

See Also

`in` | `isAlways` | `isequaln` | `isfinite` | `isinf` | `isnan` | `logical`

Introduced before R2006a

isequaln

Test symbolic objects for equality, treating NaN values as equal

Syntax

```
isequaln(A,B)
isequaln(A1,A2,...,An)
```

Description

`isequaln(A,B)` returns logical 1 (true) if A and B are the same size and their contents are of equal value. Otherwise, `isequaln` returns logical 0 (false). All NaN (not a number) values are considered to be equal to each other. `isequaln` recursively compares the contents of symbolic data structures and the properties of objects. If all contents in the respective locations are equal, `isequaln` returns logical 1 (true).

`isequaln(A1,A2,...,An)` returns logical 1 (true) if all the inputs are equal.

Examples

Compare Two Expressions

Use `isequaln` to compare these two expressions:

```
syms x
isequaln(abs(x), x)

ans =
    logical
     0
```

For positive x, these expressions are identical:

```
assume(x > 0)
isequaln(abs(x), x)

ans =
    logical
     1
```

For further computations, remove the assumption on x by recreating it using `syms`:

```
syms x
```

Compare Two Matrices

Use `isequaln` to compare these two matrices:

```
A = hilb(3);
B = sym(A);
isequaln(A, B)
```

```
ans =
    logical
     0
```

Compare Vectors Containing NaN Values

Use `isequaln` to compare these vectors:

```
syms x
A1 = [x NaN NaN];
A2 = [x NaN NaN];
A3 = [x NaN NaN];
isequaln(A1, A2, A3)
```

```
ans =
    logical
     1
```

Input Arguments

A, B — Inputs to compare

symbolic numbers | symbolic variables | symbolic expressions | symbolic functions | symbolic vectors | symbolic matrices

Inputs to compare, specified as symbolic numbers, variables, expressions, functions, vectors, or matrices. If one of the arguments is a symbolic object and the other one is numeric, the toolbox converts the numeric object to symbolic before comparing them.

A1, A2, . . . , An — Series of inputs to compare

symbolic numbers | symbolic variables | symbolic expressions | symbolic functions | symbolic vectors | symbolic matrices

Series of inputs to compare, specified as symbolic numbers, variables, expressions, functions, vectors, or matrices. If at least one of the arguments is a symbolic object, the toolbox converts all other arguments to symbolic objects before comparing them.

Tips

- Calling `isequaln` for arguments that are not symbolic objects invokes the MATLAB `isequaln` function. If one of the arguments is symbolic, then all other arguments are converted to symbolic objects before comparison.

See Also

`in` | `isAlways` | `isequal` | `isequaln` | `isfinite` | `isinf` | `isnan`

Introduced in R2013a

isfinite

Check whether symbolic array elements are finite

Syntax

```
isfinite(A)
```

Description

`isfinite(A)` returns an array of the same size as `A` containing logical 1s (true) where the elements of `A` are finite, and logical 0s (false) where they are not. For a complex number, `isfinite` returns 1 if both the real and imaginary parts of that number are finite. Otherwise, it returns 0.

Examples

Determine Which Elements of Symbolic Array Are Finite Values

Using `isfinite`, determine which elements of this symbolic matrix are finite values:

```
isfinite(sym([pi NaN Inf; 1 + i Inf + i NaN + i]))
```

```
ans =
  2×3 logical array
   1   0   0
   1   0   0
```

Determine if Exact and Approximated Values Are Finite

Approximate these symbolic values with the 50-digit accuracy:

```
V = sym([pi, 2*pi, 3*pi, 4*pi]);
V_approx = vpa(V, 50);
```

The cotangents of the exact values are not finite:

```
cot(V)
isfinite(cot(V))

ans =
 [ Inf, Inf, Inf, Inf]
```

```
ans =
  1×4 logical array
   0   0   0   0
```

Nevertheless, the cotangents of the approximated values are finite due to the round-off errors:

```
isfinite(cot(V_approx))

ans =
  1×4 logical array
   1   1   1   1
```

Input Arguments

A — Input value

symbolic number | symbolic variable | symbolic expression | symbolic function | symbolic array | symbolic vector | symbolic matrix

Input value, specified as a symbolic number, variable, expression, or function, or as an array, vector, or matrix of symbolic numbers, variables, expressions, functions.

Tips

- For any A, exactly one of the three quantities `isfinite(A)`, `isinf(A)`, or `isnan(A)` is 1 for each element.
- Elements of A are recognized as finite if they are
 - Not symbolic NaN
 - Not symbolic Inf or -Inf
 - Not sums or products containing symbolic infinities Inf or -Inf

See Also

`in` | `isAlways` | `isequal` | `isequaln` | `isinf` | `isnan`

Introduced in R2013b

isinf

Check whether symbolic array elements are infinite

Syntax

```
isinf(A)
```

Description

`isinf(A)` returns an array of the same size as `A` containing logical 1s (true) where the elements of `A` are infinite, and logical 0s (false) where they are not. For a complex number, `isinf` returns 1 if the real or imaginary part of that number is infinite or both real and imaginary parts are infinite. Otherwise, it returns 0.

Examples

Determine Which Elements of Symbolic Array Are Infinite

Using `isinf`, determine which elements of this symbolic matrix are infinities:

```
isinf(sym([pi NaN Inf; 1 + i Inf + i NaN + i]))

ans =
    2×3 logical array
     0     0     1
     0     1     0
```

Determine if Exact and Approximated Values Are Infinite

Approximate these symbolic values with the 50-digit accuracy:

```
V = sym([pi, 2*pi, 3*pi, 4*pi]);
V_approx = vpa(V, 50);
```

The cotangents of the exact values are infinite:

```
cot(V)
isinf(cot(V))

ans =
 [ Inf, Inf, Inf, Inf]
```

```
ans =
    1×4 logical array
     1     1     1     1
```

Nevertheless, the cotangents of the approximated values are not infinite due to the round-off errors:

```
isinf(cot(V_approx))

ans =
    1×4 logical array
     0     0     0     0
```

Input Arguments

A — Input value

symbolic number | symbolic variable | symbolic expression | symbolic function | symbolic array | symbolic vector | symbolic matrix

Input value, specified as a symbolic number, variable, expression, or function, or as an array, vector, or matrix of symbolic numbers, variables, expressions, functions.

Tips

- For any A, exactly one of the three quantities `isfinite(A)`, `isinf(A)`, or `isnan(A)` is 1 for each element.
- The elements of A are recognized as infinite if they are
 - Symbolic `Inf` or `-Inf`
 - Sums or products containing symbolic `Inf` or `-Inf` and not containing the value `NaN`.

See Also

`in` | `isAlways` | `isequal` | `isequaln` | `isfinite` | `isnan`

Introduced in R2013b

isLowIndexDAE

Check if differential index of system of equations is lower than 2

Syntax

```
isLowIndexDAE(eqs, vars)
```

Description

`isLowIndexDAE(eqs, vars)` checks if the system `eqs` of first-order semilinear differential algebraic equations (DAEs) has a low differential index. If the differential index of the system is 0 or 1, then `isLowIndexDAE` returns logical 1 (true). If the differential index of `eqs` is higher than 1, then `isLowIndexDAE` returns logical 0 (false).

The number of equations `eqs` must match the number of variables `vars`.

Examples

Check Differential Index of DAE System

Check if a system of first-order semilinear DAEs has a low differential index (0 or 1).

Create the following system of two differential algebraic equations. Here, $x(t)$ and $y(t)$ are the state variables of the system. Specify the equations and variables as two symbolic vectors: equations as a vector of symbolic equations, and variables as a vector of symbolic function calls.

```
syms x(t) y(t)
eqs = [diff(x(t),t) == x(t) + y(t), x(t)^2 + y(t)^2 == 1];
vars = [x(t), y(t)];
```

Use `isLowIndexDAE` to check the differential order of the system. The differential order of this system is 1. For systems of index 0 and 1, `isLowIndexDAE` returns 1 (true).

```
isLowIndexDAE(eqs, vars)
```

```
ans =
    logical
     1
```

Reduce Differential Index of DAE System

Check if the following DAE system has a low or high differential index. If the index is higher than 1, then use `reduceDAEIndex` to reduce it.

Create the following system of two differential algebraic equations. Here, $x(t)$, $y(t)$, and $z(t)$ are the state variables of the system. Specify the equations and variables as two symbolic vectors: equations as a vector of symbolic equations, and variables as a vector of symbolic function calls.

```
syms x(t) y(t) z(t) f(t)
eqs = [diff(x(t),t) == x(t) + z(t), ...
       diff(y(t),t) == f(t), x(t) == y(t)];
vars = [x(t), y(t), z(t)];
```

Use `isLowIndexDAE` to check the differential index of the system. For this system `isLowIndexDAE` returns `0` (`false`). This means that the differential index of the system is 2 or higher.

```
isLowIndexDAE(eqs, vars)
```

```
ans =
    logical
     0
```

Use `reduceDAEIndex` to rewrite the system so that the differential index is 1. Calling this function with four output arguments also shows the differential index of the original system. The new system has one additional state variable, `Dyt(t)`.

```
[newEqs, newVars, ~, oldIndex] = reduceDAEIndex(eqs, vars)
```

```
newEqs =
    diff(x(t), t) - z(t) - x(t)
                Dyt(t) - f(t)
                x(t) - y(t)
    diff(x(t), t) - Dyt(t)
```

```
newVars =
    x(t)
    y(t)
    z(t)
    Dyt(t)
```

```
oldIndex =
     2
```

Check if the differential order of the new system is lower than 2.

```
isLowIndexDAE(newEqs, newVars)
```

```
ans =
    logical
     1
```

Input Arguments

eqs — System of first-order semilinear differential algebraic equations

vector of symbolic equations | vector of symbolic expressions

System of first-order semilinear differential algebraic equations, specified as a vector of symbolic equations or expressions.

vars — State variables

vector of symbolic functions | vector of symbolic function calls

State variables, specified as a vector of symbolic functions or function calls, such as `x(t)`.

Example: `[x(t), y(t)]`

See Also

`daeFunction` | `decic` | `findDecoupledBlocks` | `incidenceMatrix` | `massMatrixForm` | `odeFunction` | `reduceDAEIndex` | `reduceDAEToODE` | `reduceDifferentialOrder` | `reduceRedundancies`

Topics

“Solve Differential Algebraic Equations (DAEs)” on page 2-194

Introduced in R2014b

isnan

Check whether symbolic array elements are NaNs

Syntax

```
isnan(A)
```

Description

`isnan(A)` returns an array of the same size as `A` containing logical 1s (true) where the elements of `A` are symbolic NaNs, and logical 0s (false) where they are not.

Examples

Determine Which Elements of Symbolic Array Are NaNs

Using `isnan`, determine which elements of this symbolic matrix are NaNs:

```
isnan(sym([pi NaN Inf; 1 + i Inf + i NaN + i]))
```

```
ans =
    2×3 logical array
     0     1     0
     0     0     1
```

Input Arguments

A — Input value

symbolic number | symbolic variable | symbolic expression | symbolic function | symbolic array | symbolic vector | symbolic matrix

Input value, specified as a symbolic number, variable, expression, or function, or as an array, vector, or matrix of symbolic numbers, variables, expressions, functions.

Tips

- For any `A`, exactly one of the three quantities `isfinite(A)`, `isinf(A)`, or `isnan(A)` is 1 for each element.
- Symbolic expressions and functions containing NaN evaluate to NaN. For example, `sym(NaN + i)` returns symbolic NaN.

See Also

`isAlways` | `isequal` | `isequaln` | `isfinite` | `isinf`

Introduced in R2013b

isolate

Isolate variable or expression in equation

Syntax

```
isolate(eqn, expr)
```

Description

`isolate(eqn, expr)` rearranges the equation `eqn` so that the expression `expr` appears on the left side. The result is similar to solving `eqn` for `expr`. If `isolate` cannot isolate `expr`, it moves all terms containing `expr` to the left side. The output of `isolate` lets you eliminate `expr` from `eqn` by using `subs`.

Examples

Isolate Variable in Equation

Isolate x in the equation $a*x^2 + b*x + c == 0$.

```
syms x a b c
eqn = a*x^2 + b*x + c == 0;
xSol = isolate(eqn, x)
```

```
xSol =
x == -(b + (b^2 - 4*a*c)^(1/2))/(2*a)
```

You can use the output of `isolate` to eliminate the variable from the equation using `subs`.

Eliminate x from `eqn` by substituting `lhs(xSol)` for `rhs(xSol)`.

```
eqn2 = subs(eqn, lhs(xSol), rhs(xSol))
```

```
eqn2 =
c + (b + (b^2 - 4*a*c)^(1/2))^2/(4*a) - (b*(b + (b^2 - 4*a*c)^(1/2)))/(2*a) == 0
```

Isolate Expression in Equation

Isolate $y(t)$ in the following equation.

```
syms y(t)
eqn = a*y(t)^2 + b*c == 0;
isolate(eqn, y(t))
```

```
ans =
y(t) == ((-b)^(1/2)*c^(1/2))/a^(1/2)
```

Isolate $a*y(t)$ in the same equation.

```
isolate(eqn, a*y(t))
```

```
ans =
a*y(t) == -(b*c)/y(t)
```

isolate Returns Simplest Solution

For equations with multiple solutions, `isolate` returns the simplest solution.

Demonstrate this behavior by isolating x in $\sin(x) == 0$, which has multiple solutions at 0 , π , $3\pi/2$, and so on.

```
isolate(sin(x) == 0, x)
```

```
ans =  
x == 0
```

`isolate` does not consider special cases when returning the solution. Instead, `isolate` returns a general solution that is not guaranteed to hold for all values of the variables in the equation.

Isolate x in the equation $a*x^2/(x-a) == 1$. The returned value of x does not hold in the special case $a = 0$.

```
syms a x  
isolate(a*x^2/(x-a) == 1, x)
```

```
ans =  
x == ((-(2*a - 1)*(2*a + 1))^(1/2) + 1)/(2*a)
```

isolate Follows Assumptions on Variables

`isolate` returns only results that are consistent with the assumptions on the variables in the equation.

First, assume x is negative, and then isolate x in the equation $x^4 == 1$.

```
syms x  
assume(x < 0)  
eqn = x^4 == 1;  
isolate(x^4 == 1, x)
```

```
ans =  
x == -1
```

Remove the assumption. `isolate` chooses a different solution to return.

```
assume(x, 'clear')  
isolate(x^4 == 1, x)
```

```
ans =  
x == 1
```

Tips

- If `eqn` has no solution, `isolate` errors. `isolate` also ignores special cases. If the only solutions to `eqn` are special cases, then `isolate` ignores those special cases and errors.
- The returned solution is not guaranteed to hold for all values of the variables in the solution.
- `expr` cannot be a mathematical constant such as `pi`.

Input Arguments

eqn — Input equation

symbolic equation

Input equation, specified as a symbolic equation.

Example: $a*x^2 + b*x + c == 0$

expr — Variable or expression to isolate

symbolic variable | symbolic expression

Variable or expression to isolate, specified as a symbolic variable or expression.

See Also

lhs | linsolve | rhs | solve | subs

Topics

“Solve Algebraic Equation” on page 2-153

“Solve System of Algebraic Equations” on page 2-160

“Solve Equations Numerically” on page 2-176

“Solve System of Linear Equations” on page 2-173

Introduced in R2017a

isPrimitiveRoot

Determine which array elements are primitive roots

Syntax

```
TF = isPrimitiveRoot(G,N)
```

Description

`TF = isPrimitiveRoot(G,N)` returns a logical array containing 1 (`true`) for the corresponding elements of `G` that are primitive roots on page 4-782 modulo `N`, and 0 (`false`) for the corresponding elements that are not primitive roots. The elements of `G` must be integers, and the elements of `N` must be positive integers.

Examples

Find Primitive Roots Modulo 11

Create a row vector containing positive integers from 1 to 11. Determine if they are primitive roots modulo 11.

```
G = 1:11;
TF = isPrimitiveRoot(G,11)
```

```
TF = 1x11 logical array
```

```
    0    1    0    0    0    1    1    1    0    0    0
```

Find the smallest positive integer that is a primitive root modulo 11.

```
Z1 = find(TF,1)
```

```
Z1 = 2
```

Show all positive integers (less than or equal to 11) that are primitive roots modulo 11.

```
Z = G(TF)
```

```
Z = 1x4
```

```
    2    6    7    8
```

Find Primitive Roots Modulo 15

Create a row vector containing integers from -15 to 15. Find the integers that are primitive roots modulo 15.

```
G = -15:15;  
Z = G(isPrimitiveRoot(G,15))  
  
Z =  
  
1x0 empty double row vector
```

The integer 15 has no primitive roots.

Input Arguments

G — Base

number | vector | matrix | array | symbolic number | symbolic array

Base, specified as a number, vector, matrix, array, symbolic number, or symbolic array. The elements of G must be integers. G and N must be the same size, or else one of them must be a scalar.

Data Types: single | double | sym

N — Divisor

number | vector | matrix | array | symbolic number | symbolic array

Divisor, specified as a number, vector, matrix, array, symbolic number, or symbolic array. The elements of N must be positive integers. G and N must be the same size, or else one of them must be a scalar.

Data Types: single | double | sym

More About

Primitive Root

A number g is a primitive root modulo n if every number a coprime to n (or $\gcd(a, n) = 1$) is congruent to a power of g modulo n . That is, g is a primitive root modulo n if for every integer a coprime to n , there is an integer k such that $g^k \equiv a \pmod{n}$. The primitive roots modulo n exist if and only if $n = 1, 2, 4, p^k$, or $2p^k$, where p is an odd prime and k is a positive integer.

For example, the integer 2 is a primitive root modulo 5 because $2^k \equiv a \pmod{5}$ is satisfied for every integer a that is coprime to 5.

$$2^1 = 2 \equiv 2 \pmod{5}$$

$$2^2 = 4 \equiv 4 \pmod{5}$$

$$2^3 = 8 \equiv 3 \pmod{5}$$

$$2^4 = 16 \equiv 1 \pmod{5}$$

⋮

See Also

eulerPhi | prevprime | nextprime | nthprime

Introduced in R2020a

isSymType

Determine whether symbolic object is specific type

Syntax

```
TF = isSymType(symObj, type)
TF = isSymType(symObj, funType, vars)
```

Description

`TF = isSymType(symObj, type)` returns logical 1 (true) if the symbolic object `symObj` is of type `type`, and logical 0 (false) otherwise. The input `type` must be a case-sensitive string scalar or character vector, and it can include a logical expression. For example, `isSymType(sym('3'), 'real & integer')` returns logical 1.

If `symObj` is a symbolic expression with a topmost operator of type `type`, then `isSymType(symObj, type)` also returns logical 1.

`TF = isSymType(symObj, funType, vars)` checks whether `symObj` is an unassigned symbolic function that depends on the symbolic variables `vars`.

You can set the function type `funType` to `'symfunOf'` or `'symfunDependingOn'`. For example, `syms f(x); isSymType(f, 'symfunOf', x)` returns logical 1.

Examples

Symbolic Number and Constant

Create a symbolic number. Check whether the symbolic number is of type `'rational'`.

```
a = sym('1/2');
TF = isSymType(a, 'rational')
```

```
TF = logical
    1
```

Now construct a symbolic array by including symbolic numbers or constants in the array elements.

```
N = [sym('1/2'), vpa(0.5), pi, vpa(pi), 1i]
```

```
N =
    (
        1/2 0.5 pi 3.1415926535897932384626433832795 i
    )
```

Check whether each array element is of type `'real'`.

```
TF = isSymType(N, 'real')
```

```
TF = 1x5 logical array
```

```
1 1 0 1 0
```

Check whether each array element is of type 'integer | real'.

```
TF = isSymType(N, 'integer | real')
```

```
TF = 1x5 logical array
```

```
1 1 0 1 0
```

Check whether each array element is of type 'number'.

```
TF = isSymType(N, 'number')
```

```
TF = 1x5 logical array
```

```
1 1 0 1 1
```

Check whether each array element is of type 'constant'.

```
TF = isSymType(N, 'constant')
```

```
TF = 1x5 logical array
```

```
1 1 1 1 1
```

Topmost Operator of Symbolic Expression

Determine whether the topmost operator of a symbolic expression is of a specific type, such as 'plus' or 'power'.

Create a symbolic expression.

```
syms x
expr = x^2 + 2*x - 1
```

```
expr = x2 + 2x - 1
```

Check whether the topmost operator of expr is of type 'plus'.

```
TF = isSymType(expr, 'plus')
```

```
TF = logical
1
```

Check whether the topmost operator of expr is of type 'power'.

```
TF = isSymType(expr, 'power')
```

```
TF = logical
0
```

Now perform a symbolic square root operation in the expression.

```
expr = sqrt(x^2 + 2*x - 1)
```

```
expr =  $\sqrt{x^2 + 2x - 1}$ 
```

Check whether the topmost operator of `expr` is of type 'power'.

```
TF = isSymType(expr, 'power')
```

```
TF = logical  
    1
```

Select Specific Equations

Select specific equations that are constant on the right side.

Create an array of three symbolic equations.

```
syms r(t) x(t) y(t)  
eq1 = [x(t) == r(t)*cos(t), y(t) == r(t)*sin(t), r(t) == 5]
```

```
eq1 = (x(t) = cos(t)r(t) y(t) = r(t) sin(t) r(t) = 5)
```

Select the right side of each equation using the `rhs` function. Check whether the right side of each equation is of type 'constant'.

```
TF = isSymType(rhs(eq1), 'constant')
```

```
TF = 1x3 logical array
```

```
    0    0    1
```

Return the reduced equation that is constant on the right side.

```
eq2 = eq1(TF)
```

```
eq2 = r(t) = 5
```

Symbolic Function of Multiple Variables

Create a symbolic function of multiple variables $f(x, y)$ using `syms`. Check whether the unassigned symbolic function `f` is of type 'symfun'.

```
syms f(x,y)  
TF = isSymType(f, 'symfun')
```

```
TF = logical  
    1
```

Check whether `f` depends on the exact variable `x`.

```
TF = isSymType(f, 'symfunOf', x)
```

```
TF = logical
    0
```

Check whether f depends on the exact sequence of variables $[x \ y]$.

```
TF = isSymType(f, 'symfunOf', [x y])
```

```
TF = logical
    1
```

Check whether f depends on the variable x .

```
TF = isSymType(f, 'symfunDependingOn', x)
```

```
TF = logical
    1
```

Input Arguments

symObj — Symbolic objects

symbolic expressions | symbolic functions | symbolic variables | symbolic numbers | symbolic units

Symbolic objects, specified as symbolic expressions, symbolic functions, symbolic variables, symbolic numbers, or symbolic units.

type — Symbolic types

scalar string | character vector

Symbolic types, specified as a case-sensitive scalar string or character vector. The input type can contain a logical expression. The value options follow.

Symbolic Type Category	String Values	Examples Returning Logical 1
numbers	<ul style="list-style-type: none"> 'integer' — integer numbers 'rational' — rational numbers 'vpereal' — variable-precision floating-point real numbers 'complex' — complex numbers 'real' — real numbers, including 'integer', 'rational', and 'vpereal' 'number' — numbers, including 'integer', 'rational', 'vpereal', 'complex', and 'real' 	<ul style="list-style-type: none"> isSymType(sym(2), 'integer') isSymType(sym(1/2), 'rational') isSymType(vpa(0.5), 'vpereal') isSymType(vpa(1i), 'complex') isSymType([sym(1/2) vpa(0.5)], 'real') isSymType([vpa(1i) sym(1/2)], 'number')

Symbolic Type Category	String Values	Examples Returning Logical 1
constants	'constant' — symbolic constants, including 'number'	<code>isSymType([vpa(1i) sym(pi)], 'constant')</code>
symbolic math functions	'vpa', 'sin', 'exp', and so on — topmost symbolic math functions in symbolic expressions	<code>isSymType(vpa(sym(pi)), 'vpa')</code>
unassigned symbolic functions	<ul style="list-style-type: none"> 'F', 'g', and so on — function name of an unassigned symbolic function 'symfun' — unassigned symbolic functions 	<ul style="list-style-type: none"> <code>syms F(x); isSymType(F(x+2), 'F')</code> <code>syms g(x); isSymType(g(x), 'symfun')</code>
arithmetic operators	<ul style="list-style-type: none"> 'plus' — addition operator + and subtraction operator - 'times' — multiplication operator * and division operator / 'power' — power or exponentiation operator ^ and square root operator sqrt 	<ul style="list-style-type: none"> <code>syms x y; isSymType(2*x + y, 'plus')</code> <code>syms x y; isSymType(x*y, 'times')</code> <code>syms x y; isSymType(x^(y+2), 'power')</code>
variables	'variable' — symbolic variables	<code>isSymType(sym('x'), 'variable')</code>
units	'units' — symbolic units	<code>isSymType(symunit('m'), 'units')</code>
expressions	'expression' — symbolic expressions, including all of the preceding symbolic types	<code>isSymType(sym('x') + 1, 'expression')</code>
logical expressions	<ul style="list-style-type: none"> 'or' — logical OR operator 'and' — logical AND operator & 'not' — logical NOT operator ~ 'xor' — logical exclusive-OR operator xor 'logicalexpression' — logical expressions, including 'or', 'and', 'not', and 'xor' 	<ul style="list-style-type: none"> <code>syms x y; isSymType(x y, 'or')</code> <code>syms x y; isSymType(x&y, 'and')</code> <code>syms x; isSymType(~x, 'not')</code> <code>syms x y; isSymType(xor(x,y), 'xor')</code> <code>syms x y; isSymType(~x y, 'logicalexpression')</code>

Symbolic Type Category	String Values	Examples Returning Logical 1
equations and inequalities	<ul style="list-style-type: none"> 'eq' — equality operator == 'ne' — inequality operator ~= 'lt' — less-than operator < or greater-than operator > 'le' — less-than-or-equal-to operator <= or greater-than-or-equal-to operator >= 'equation' — symbolic equations and inequalities, including 'eq', 'ne', 'lt', and 'le' 	<ul style="list-style-type: none"> syms x; isSymType(x==2,'eq') syms x; isSymType(x~=1,'ne') syms x; isSymType(x>0,'lt') syms x; isSymType(x<=2,'le') syms x; isSymType([x>0 x~=1],'equation')
unsupported symbolic types	'unsupported' — unsupported symbolic types	

funType — Function type

'symfunOf' | 'symfunDependingOn'

Function type, specified as 'symfunOf' or 'symfunDependingOn'.

- 'symfunOf' checks whether symObj is an unassigned symbolic function that depends on the exact sequence of variables specified by the array vars. For example, syms f(x,y); isSymType(f,'symfunOf',[x y]) returns logical 1.
- 'symfunDependingOn' checks whether symObj is an unassigned symbolic function that depends on the variables specified by the array vars. For example, syms f(x,y); isSymType(f,'symfunDependingOn',x) returns logical 1.

vars — Input variables

symbolic variables | symbolic array

Input variables, specified as symbolic variables or a symbolic array.

See Also

hasSymType | sym | symFunType | symType | syms

Introduced in R2019a

isUnit

Determine if input is a symbolic unit

Syntax

```
tf = isUnit(expr)
```

Description

`tf = isUnit(expr)` returns logical 1 (true) if `expr` is a unit, or a product of powers of units, and logical 0 (false) if it is not.

Examples

Determine if Input is a Unit

Determine if an expression is a symbolic unit by using `isUnit`.

Test if `3*u.m` is a symbolic unit, where `u = symunit`. The `isUnit` function returns logical 0 (false) because `3*u.m` contains the symbolic number 3.

```
u = symunit;  
isUnit(3*u.m)
```

```
ans =  
    logical  
     0
```

Check if `u.m`, `u.mW`, and `x*u.Hz` are units, where `u = symunit`. The `isUnit` function returns the array `[1 1 0]`, meaning that the first two expressions are units but the third expression is not.

```
syms x  
units = [u.m u.mW x*u.Hz];  
isUnit(units)
```

```
ans =  
    1×3 logical array  
     1     1     0
```

Input Arguments

`expr` — Input

number | vector | matrix | multidimensional array | symbolic number | symbolic variable | symbolic vector | symbolic matrix | symbolic multidimensional array | symbolic function | symbolic expression

Input, specified as a number, vector, matrix or multidimensional array, or a symbolic number, variable, vector, matrix, multidimensional array, function, or expression.

Tips

- 1 represents a dimensionless unit. Hence, `isUnit(sym(1))` returns logical 1 (true).

See Also

`checkUnits` | `findUnits` | `newUnit` | `separateUnits` | `str2symunit` | `symunit` | `symunit2str` | `unitConversionFactor`

Topics

“Units of Measurement Tutorial” on page 2-19

“Unit Conversions and Unit Systems” on page 2-39

“Units and Unit Systems List” on page 2-25

External Websites

The International System of Units (SI)

Introduced in R2017a

iztrans

Inverse Z-transform

Syntax

```
iztrans(F)
iztrans(F,transVar)
iztrans(F,var,transVar)
```

Description

`iztrans(F)` returns the “Inverse Z-Transform” on page 4-794 of F. By default, the independent variable is z and the transformation variable is n . If F does not contain z , `iztrans` uses the function `symvar`.

`iztrans(F,transVar)` uses the transformation variable `transVar` instead of n .

`iztrans(F,var,transVar)` uses the independent variable `var` and transformation variable `transVar` instead of z and n respectively.

Examples

Inverse Z-Transform of Symbolic Expression

Compute the inverse Z-transform of $2*z/(z-2)^2$. By default, the inverse transform is in terms of n .

```
syms z
F = 2*z/(z-2)^2;
iztrans(F)
```

```
ans =
2^n + 2^n*(n - 1)
```

Specify Independent Variable and Transformation Variable

Compute the inverse Z-transform of $1/(a*z)$. By default, the independent and transformation variables are z and n , respectively.

```
syms z a
F = 1/(a*z);
iztrans(F)
```

```
ans =
kroneckerDelta(n - 1, 0)/a
```

Specify the transformation variable as m . If you specify only one variable, that variable is the transformation variable. The independent variable is still z .

```
syms m
iztrans(F,m)
```

```
ans =
kroneckerDelta(m - 1, 0)/a
```

Specify both the independent and transformation variables as a and m in the second and third arguments, respectively.

```
iztrans(F,a,m)

ans =
kroneckerDelta(m - 1, 0)/z
```

Inverse Z-Transforms Involving Kronecker Delta Function

Compute the inverse Z-transforms of these expressions. The results involve the Kronecker Delta function.

```
syms n z
iztrans(1/z,z,n)

ans =
kroneckerDelta(n - 1, 0)

f = (z^3 + 3*z^2)/z^5;
iztrans(f,z,n)

ans =
kroneckerDelta(n - 2, 0) + 3*kroneckerDelta(n - 3, 0)
```

Inverse Z-Transform of Array Inputs

Find the inverse Z-transform of the matrix M . Specify the independent and transformation variables for each matrix entry by using matrices of the same size. When the arguments are nonscalars, `iztrans` acts on them element-wise.

```
syms a b c d w x y z
M = [exp(x) 1; sin(y) i*z];
vars = [w x; y z];
transVars = [a b; c d];
iztrans(M,vars,transVars)

ans =
[ exp(x)*kroneckerDelta(a, 0), kroneckerDelta(b, 0)]
[      iztrans(sin(y), y, c),  iztrans(z, z, d)*1i]
```

If `iztrans` is called with both scalar and nonscalar arguments, then it expands the scalars to match the nonscalars by using scalar expansion. Nonscalar arguments must be the same size.

```
syms w x y z a b c d
iztrans(x,vars,transVars)

ans =
[ x*kroneckerDelta(a, 0),      iztrans(x, x, b)]
[ x*kroneckerDelta(c, 0), x*kroneckerDelta(d, 0)]
```

Inverse Z-Transform of Symbolic Function

Compute the Inverse Z-transform of symbolic functions. When the first argument contains symbolic functions, then the second argument must be a scalar.

```
syms f1(x) f2(x) a b
f1(x) = exp(x);
```

```
f2(x) = x;
iztrans([f1, f2],x,[a, b])

ans =
[ iztrans(exp(x), x, a), iztrans(x, x, b)]
```

If Inverse Z-Transform Cannot Be Found

If `iztrans` cannot compute the inverse transform, it returns an unevaluated call.

```
syms F(z) n
F(z) = exp(z);
f = iztrans(F,z,n)
```

```
f =
iztrans(exp(z), z, n)
```

Return the original expression by using `ztrans`.

```
ztrans(f,n,z)
```

```
ans =
exp(z)
```

Input Arguments

F — Input

symbolic expression | symbolic function | symbolic vector | symbolic matrix

Input, specified as a symbolic expression, function, vector, or matrix.

var — Independent variable

x (default) | symbolic variable | symbolic expression | symbolic vector | symbolic matrix

Independent variable, specified as a symbolic variable, expression, vector, or matrix. This variable is often called the "complex frequency variable." If you do not specify the variable, then `iztrans` uses `z`. If `F` does not contain `z`, then `iztrans` uses the function `symvar`.

transVar — Transformation variable

x (default) | t | symbolic variable | symbolic expression | symbolic vector | symbolic matrix

Transformation variable, specified as a symbolic variable, expression, vector, or matrix. It is often called the "time variable" or "space variable." By default, `iztrans` uses `n`. If `n` is the independent variable of `F`, then `iztrans` uses `k`.

More About

Inverse Z-Transform

Where R is a positive number, such that the function $F = F(z)$ is analytic on and outside the circle $|z| = R$, the inverse Z-transform is

$$f(n) = \frac{1}{2\pi i} \oint_{|z|=R} F(z)z^{n-1}dz, \quad n = 0, 1, 2, \dots$$

Tips

- If any argument is an array, then `iztrans` acts element-wise on all elements of the array.
- If the first argument contains a symbolic function, then the second argument must be a scalar.
- To compute the direct Z-transform, use `ztrans`.

See Also

`fourier` | `ifourier` | `ilaplace` | `kronckerDelta` | `laplace` | `ztrans`

Topics

“Solve Difference Equations Using Z-Transform” on page 2-224

Introduced before R2006a

jacobiAM

Jacobi amplitude function

Syntax

```
jacobiAM(u,m)
```

Description

`jacobiAM(u,m)` returns the “Jacobi Amplitude Function” on page 4-798 of `u` and `m`. If `u` or `m` is an array, then `jacobiAM` acts element-wise.

Examples

Calculate Jacobi Amplitude Function for Numeric Inputs

```
jacobiAM(2,1)
```

```
ans =  
    1.3018
```

Call `jacobiAM` on array inputs. `jacobiAM` acts element-wise when `u` or `m` is an array.

```
jacobiAM([2 1 -3],[1 2 3])
```

```
ans =  
    1.3018    0.7370    0.6155
```

Calculate Jacobi Amplitude Function for Symbolic Numbers

Convert numeric input to symbolic form using `sym`, and find the Jacobi amplitude function. For symbolic input where `u = 0` or `m = 0` or `1`, `jacobiAM` returns exact symbolic output.

```
jacobiAM(sym(2),sym(1))
```

```
ans =  
2*atan(exp(2)) - pi/2
```

Show that for other values of `u` or `m`, `jacobiAM` returns an unevaluated function call.

```
jacobiAM(sym(2),sym(3))
```

```
ans =  
jacobiAM(2, 3)
```

Find Jacobi Amplitude Function for Symbolic Variables or Expressions

For symbolic variables or expressions, `jacobiAM` returns the unevaluated function call.

```
syms x y
f = jacobiAM(x,y)
```

```
f =
jacobiAM(x, y)
```

Substitute values for the variables by using `subs`, and convert values to double by using `double`.

```
f = subs(f, [x y], [3 5])
```

```
f =
jacobiAM(3, 5)
```

```
fVal = double(f)
```

```
fVal =
    0.0311
```

Calculate `f` to higher precision using `vpa`.

```
fVal = vpa(f)
```

```
fVal =
0.031149815412430844987208470634926
```

Plot Jacobi Amplitude Function

Plot the Jacobi amplitude function using `fcontour`. Set `u` on the x-axis and `m` on the y-axis by using the symbolic function `f` with the variable order `(u,m)`. Fill plot contours by setting `Fill` to `on`.

```
syms f(u,m)
f(u,m) = jacobiAM(u,m);
fcontour(f,'Fill','on')
title('Jacobi Amplitude Function')
xlabel('u')
ylabel('m')
```

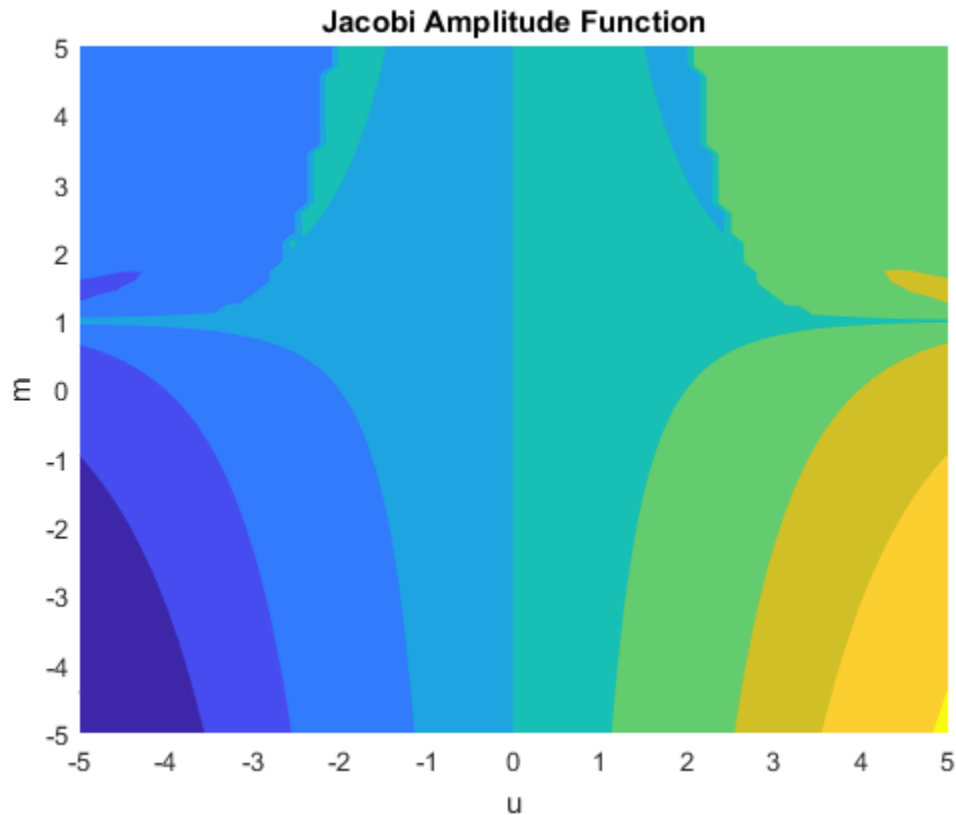

Input Arguments

u – Input

number | vector | matrix | multidimensional array | symbolic number | symbolic variable | symbolic vector | symbolic matrix | symbolic multidimensional array | symbolic function | symbolic expression

Input, specified as a number, vector, matrix, or multidimensional array, or a symbolic number, variable, vector, matrix, multidimensional array, function, or expression.

m – Input

number | vector | matrix | multidimensional array | symbolic number | symbolic variable | symbolic vector | symbolic matrix | symbolic multidimensional array | symbolic function | symbolic expression

Input, specified as a number, vector, matrix, or multidimensional array, or a symbolic number, variable, vector, matrix, multidimensional array, function, or expression.

More About

Jacobi Amplitude Function

The Jacobi amplitude function $\text{am}(u,m)$ is defined by $\text{am}(u,m) = \varphi$ where $F(\varphi,m) = u$ and F represents the incomplete elliptic integral of the first kind. F is implemented as `ellipticF`.

See Also

ellipticF | jacobiCD | jacobiCN | jacobiCS | jacobiDC | jacobiDN | jacobiDS | jacobiNC |
jacobiND | jacobiNS | jacobiSC | jacobiSD | jacobiSN | jacobiZeta

Introduced in R2017b

Jacobian

Jacobian matrix

Syntax

```
jacobian(f,v)
```

Description

`jacobian(f,v)` computes the Jacobian matrix on page 4-801 of `f` with respect to `v`. The (i,j) element of the result is $\frac{\partial f(i)}{\partial v(j)}$.

Examples

Jacobian of Vector Function

The Jacobian of a vector function is a matrix of the partial derivatives of that function.

Compute the Jacobian matrix of $[x*y*z, y^2, x + z]$ with respect to $[x, y, z]$.

```
syms x y z
jacobian([x*y*z, y^2, x + z], [x, y, z])

ans =
[ y*z, x*z, x*y]
[  0, 2*y,  0]
[  1,  0,  1]
```

Now, compute the Jacobian of $[x*y*z, y^2, x + z]$ with respect to $[x; y; z]$.

```
jacobian([x*y*z, y^2, x + z], [x; y; z])

ans =

[ y*z, x*z, x*y]
[  0, 2*y,  0]
[  1,  0,  1]
```

The Jacobian matrix is invariant to the orientation of the vector in the second input position.

Jacobian of Scalar Function

The Jacobian of a scalar function is the transpose of its gradient.

Compute the Jacobian of $2*x + 3*y + 4*z$ with respect to $[x, y, z]$.

```
syms x y z
jacobian(2*x + 3*y + 4*z, [x, y, z])

ans =
[ 2, 3, 4]
```

Now, compute the gradient of the same expression.

```
gradient(2*x + 3*y + 4*z, [x, y, z])
```

```
ans =
     2
     3
     4
```

Jacobian with Respect to Scalar

The Jacobian of a function with respect to a scalar is the first derivative of that function. For a vector function, the Jacobian with respect to a scalar is a vector of the first derivatives.

Compute the Jacobian of $[x^2*y, x*\sin(y)]$ with respect to x .

```
syms x y
jacobian([x^2*y, x*sin(y)], x)
```

```
ans =
     2*x*y
     sin(y)
```

Now, compute the derivatives.

```
diff([x^2*y, x*sin(y)], x)
```

```
ans =
 [ 2*x*y, sin(y)]
```

Input Arguments

f — Scalar or vector function

symbolic expression | symbolic function | symbolic vector

Scalar or vector function, specified as a symbolic expression, function, or vector. If f is a scalar, then the Jacobian matrix of f is the transposed gradient of f .

v — Vector of variables with respect to which you compute Jacobian

symbolic variable | symbolic vector

Vector of variables with respect to which you compute Jacobian, specified as a symbolic variable or vector of symbolic variables. If v is a scalar, then the result is equal to the transpose of $\text{diff}(f, v)$. If v is an empty symbolic object, such as $\text{sym}([])$, then `jacobian` returns an empty symbolic object.

More About

Jacobian Matrix

The Jacobian matrix of the vector function $f = (f_1(x_1, \dots, x_n), \dots, f_n(x_1, \dots, x_n))$ is the matrix of the derivatives of f :

$$J(x_1, \dots, x_n) = \begin{bmatrix} \frac{\partial f_1}{\partial x_1} & \dots & \frac{\partial f_1}{\partial x_n} \\ \vdots & \ddots & \vdots \\ \frac{\partial f_n}{\partial x_1} & \dots & \frac{\partial f_n}{\partial x_n} \end{bmatrix}$$

See Also

`curl` | `diff` | `divergence` | `gradient` | `hessian` | `laplacian` | `potential` | `vectorPotential`

Introduced before R2006a

jacobiCD

Jacobi CD elliptic function

Syntax

```
jacobiCD(u,m)
```

Description

`jacobiCD(u,m)` returns the “Jacobi CD Elliptic Function” on page 4-805 of `u` and `m`. If `u` or `m` is an array, then `jacobiCD` acts element-wise.

Examples

Calculate Jacobi CD Elliptic Function for Numeric Inputs

```
jacobiCD(2,1)
```

```
ans =
     1
```

Call `jacobiCD` on array inputs. `jacobiCD` acts element-wise when `u` or `m` is an array.

```
jacobiCD([2 1 -3],[1 2 3])
```

```
ans =
     1.0000     2.3829 -178.6290
```

Calculate Jacobi CD Elliptic Function for Symbolic Numbers

Convert numeric input to symbolic form using `sym`, and find the Jacobi CD elliptic function. For symbolic input where `u = 0` or `m = 0` or `1`, `jacobiCD` returns exact symbolic output.

```
jacobiCD(sym(2),sym(1))
```

```
ans =
     1
```

Show that for other values of `u` or `m`, `jacobiCD` returns an unevaluated function call.

```
jacobiCD(sym(2),sym(3))
```

```
ans =
jacobiCD(2, 3)
```

Find Jacobi CD Elliptic Function for Symbolic Variables or Expressions

For symbolic variables or expressions, `jacobiCD` returns the unevaluated function call.

```
syms x y
f = jacobiCD(x,y)
```

```
f =
jacobiCD(x, y)
```

Substitute values for the variables by using `subs`, and convert values to double by using `double`.

```
f = subs(f, [x y], [3 5])
```

```
f =
jacobiCD(3, 5)
```

```
fVal = double(f)
```

```
fVal =
    1.0019
```

Calculate `f` to higher precision using `vpa`.

```
fVal = vpa(f)
```

```
fVal =
1.0019475527333315357888731083364
```

Plot Jacobi CD Elliptic Function

Plot the Jacobi CD elliptic function using `fcontour`. Set `u` on the x-axis and `m` on the y-axis by using the symbolic function `f` with the variable order `(u,m)`. Fill plot contours by setting `Fill` to `on`.

```
syms f(u,m)
f(u,m) = jacobiCD(u,m);
fcontour(f,'Fill','on')
title('Jacobi CD Elliptic Function')
xlabel('u')
ylabel('m')
```

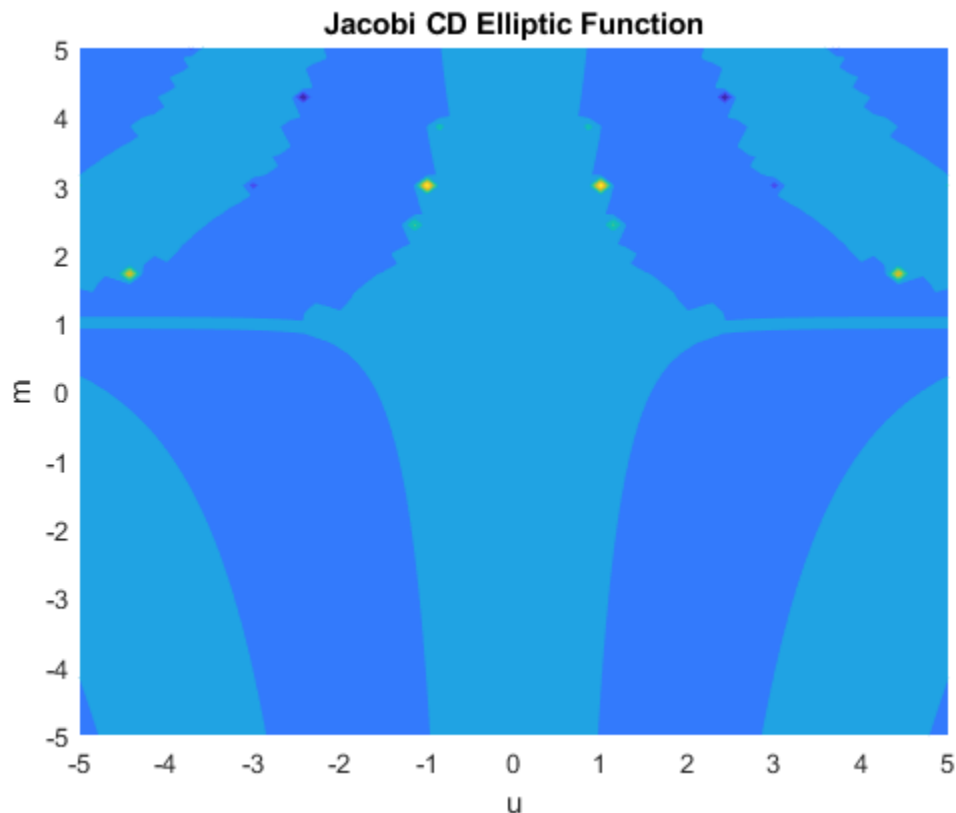

Input Arguments

u – Input

number | vector | matrix | multidimensional array | symbolic number | symbolic variable | symbolic vector | symbolic matrix | symbolic multidimensional array | symbolic function | symbolic expression

Input, specified as a number, vector, matrix, or multidimensional array, or a symbolic number, variable, vector, matrix, multidimensional array, function, or expression.

m – Input

number | vector | matrix | multidimensional array | symbolic number | symbolic variable | symbolic vector | symbolic matrix | symbolic multidimensional array | symbolic function | symbolic expression

Input, specified as a number, vector, matrix, or multidimensional array, or a symbolic number, variable, vector, matrix, multidimensional array, function, or expression.

More About

Jacobi CD Elliptic Function

The Jacobi CD elliptic function is

$$\text{cd}(u,m) = \text{cn}(u,m)/\text{dn}(u,m)$$

where cn and dn are the respective Jacobi elliptic functions.

The Jacobi elliptic functions are meromorphic and doubly periodic in their first argument with periods $4K(m)$ and $4iK'(m)$, where K is the complete elliptic integral of the first kind, implemented as `ellipticK`.

See Also

`ellipticK` | `jacobiAM` | `jacobiCN` | `jacobiCS` | `jacobiDC` | `jacobiDN` | `jacobiDS` | `jacobiNC` | `jacobiND` | `jacobiNS` | `jacobiSC` | `jacobiSD` | `jacobiSN` | `jacobiZeta`

Introduced in R2017b

jacobiCN

Jacobi CN elliptic function

Syntax

```
jacobiCN(u,m)
```

Description

`jacobiCN(u,m)` returns the “Jacobi CN Elliptic Function” on page 4-808 of `u` and `m`. If `u` or `m` is an array, then `jacobiCN` acts element-wise.

Examples

Calculate Jacobi CN Elliptic Function for Numeric Inputs

```
jacobiCN(2,1)
```

```
ans =  
    0.2658
```

Call `jacobiCN` on array inputs. `jacobiCN` acts element-wise when `u` or `m` is an array.

```
jacobiCN([2 1 -3],[1 2 3])
```

```
ans =  
    0.2658    0.7405    0.8165
```

Calculate Jacobi CN Elliptic Function for Symbolic Numbers

Convert numeric input to symbolic form using `sym`, and find the Jacobi CN elliptic function. For symbolic input where `u = 0` or `m = 0` or `1`, `jacobiCN` returns exact symbolic output.

```
jacobiCN(sym(2),sym(1))
```

```
ans =  
1/cosh(2)
```

Show that for other values of `u` or `m`, `jacobiCN` returns an unevaluated function call.

```
jacobiCN(sym(2),sym(3))
```

```
ans =  
jacobiCN(2, 3)
```

Find Jacobi CN Elliptic Function for Symbolic Variables or Expressions

For symbolic variables or expressions, `jacobiCN` returns the unevaluated function call.

```
syms x y  
f = jacobiCN(x,y)
```

```
f =  
jacobiCN(x, y)
```

Substitute values for the variables by using `subs`, and convert values to double by using `double`.

```
f = subs(f, [x y], [3 5])
```

```
f =
jacobiCN(3, 5)
```

```
fVal = double(f)
```

```
fVal =
    0.9995
```

Calculate `f` to higher precision using `vpa`.

```
fVal = vpa(f)
```

```
fVal =
0.9995148837279268257000709197021
```

Plot Jacobi CN Elliptic Function

Plot the Jacobi CN elliptic function using `fcontour`. Set `u` on the x-axis and `m` on the y-axis by using the symbolic function `f` with the variable order `(u,m)`. Fill plot contours by setting `Fill` to `on`.

```
syms f(u,m)
f(u,m) = jacobiCN(u,m);
fcontour(f,'Fill','on')
title('Jacobi CN Elliptic Function')
xlabel('u')
ylabel('m')
```

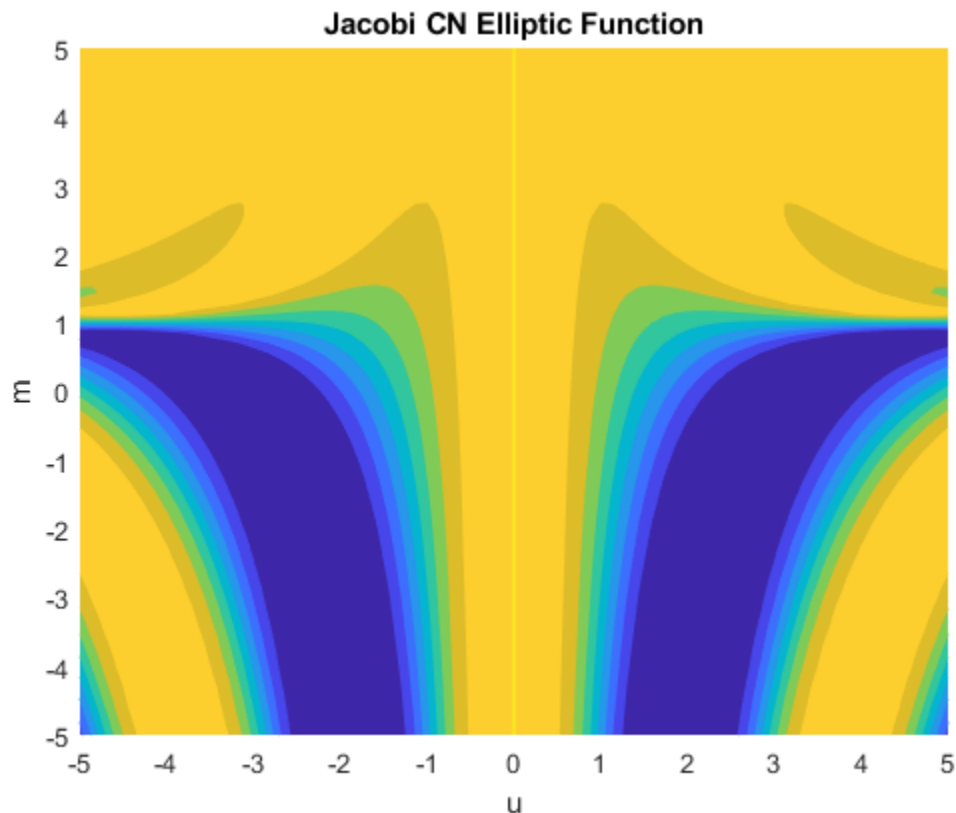

Input Arguments

u – Input

number | vector | matrix | multidimensional array | symbolic number | symbolic variable | symbolic vector | symbolic matrix | symbolic multidimensional array | symbolic function | symbolic expression

Input, specified as a number, vector, matrix, or multidimensional array, or a symbolic number, variable, vector, matrix, multidimensional array, function, or expression.

m – Input

number | vector | matrix | multidimensional array | symbolic number | symbolic variable | symbolic vector | symbolic matrix | symbolic multidimensional array | symbolic function | symbolic expression

Input, specified as a number, vector, matrix, or multidimensional array, or a symbolic number, variable, vector, matrix, multidimensional array, function, or expression.

More About

Jacobi CN Elliptic Function

The Jacobi CN elliptic function is $\text{cn}(u,m) = \cos(\text{am}(u,m))$ where am is the Jacobi amplitude function.

The Jacobi elliptic functions are meromorphic and doubly periodic in their first argument with periods $4K(m)$ and $4iK'(m)$, where K is the complete elliptic integral of the first kind, implemented as `ellipticK`.

See Also

`ellipticK` | `jacobiAM` | `jacobiCD` | `jacobiCS` | `jacobiDC` | `jacobiDN` | `jacobiDS` | `jacobiNC` | `jacobiND` | `jacobiNS` | `jacobiSC` | `jacobiSD` | `jacobiSN` | `jacobiZeta`

Introduced in R2017b

jacobiCS

Jacobi CS elliptic function

Syntax

```
jacobiCS(u,m)
```

Description

`jacobiCS(u,m)` returns the “Jacobi CS Elliptic Function” on page 4-811 of *u* and *m*. If *u* or *m* is an array, then `jacobiCS` acts element-wise.

Examples

Calculate Jacobi CS Elliptic Function for Numeric Inputs

```
jacobiCS(2,1)
```

```
ans =
    0.2757
```

Call `jacobiCS` on array inputs. `jacobiCS` acts element-wise when *u* or *m* is an array.

```
jacobiCS([2 1 -3],[1 2 3])
```

```
ans =
    0.2757    1.1017    1.4142
```

Calculate Jacobi CS Elliptic Function for Symbolic Numbers

Convert numeric input to symbolic form using `sym`, and find the Jacobi CS elliptic function. For symbolic input where $u = 0$ or $m = 0$ or 1 , `jacobiCS` returns exact symbolic output.

```
jacobiCS(sym(2),sym(1))
```

```
ans =
1/sinh(2)
```

Show that for other values of *u* or *m*, `jacobiCS` returns an unevaluated function call.

```
jacobiCS(sym(2),sym(3))
```

```
ans =
jacobiCS(2, 3)
```

Find Jacobi CS Elliptic Function for Symbolic Variables or Expressions

For symbolic variables or expressions, `jacobiCS` returns the unevaluated function call.

```
syms x y
f = jacobiCS(x,y)
```

```
f =
jacobiCS(x, y)
```

Substitute values for the variables by using `subs`, and convert values to double by using `double`.

```
f = subs(f, [x y], [3 5])
```

```
f =
jacobiCS(3, 5)
```

```
fVal = double(f)
```

```
fVal =
    32.0925
```

Calculate `f` to higher precision using `vpa`.

```
fVal = vpa(f)
```

```
fVal =
32.092535022751828816106562829547
```

Plot Jacobi CS Elliptic Function

Plot the Jacobi CS elliptic function using `fcontour`. Set `u` on the x-axis and `m` on the y-axis by using the symbolic function `f` with the variable order `(u,m)`. Fill plot contours by setting `Fill` to `on`.

```
syms f(u,m)
f(u,m) = jacobiCS(u,m);
fcontour(f,'Fill','on')
title('Jacobi CS Elliptic Function')
xlabel('u')
ylabel('m')
```

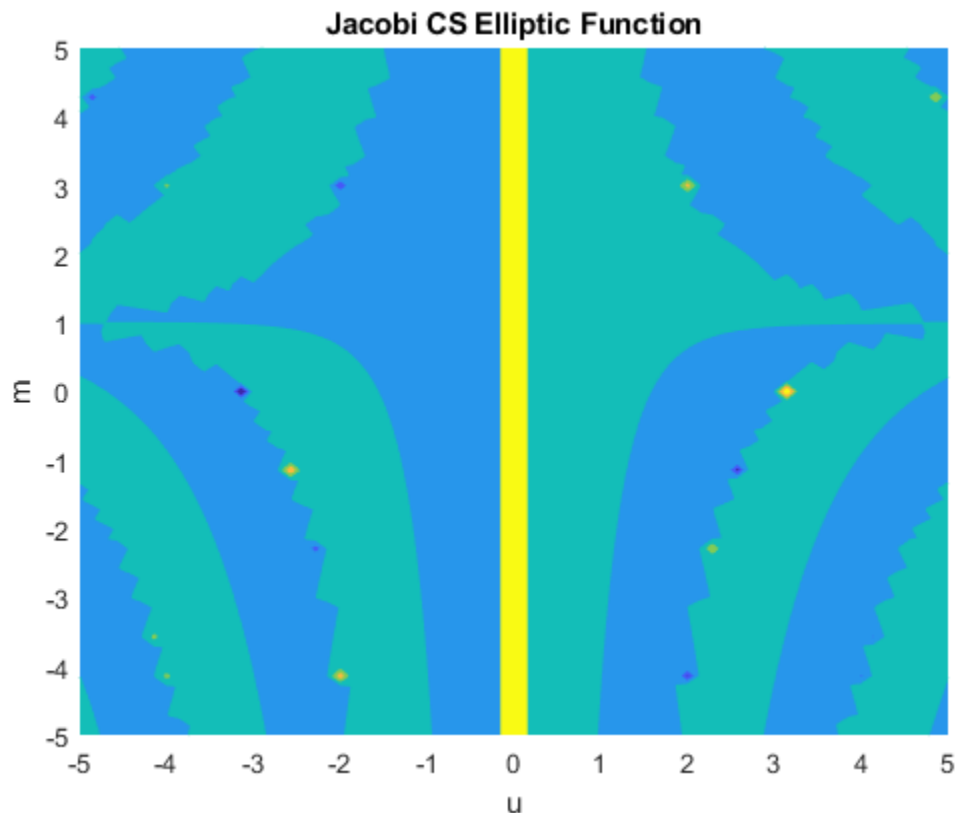

Input Arguments

u – Input

number | vector | matrix | multidimensional array | symbolic number | symbolic variable | symbolic vector | symbolic matrix | symbolic multidimensional array | symbolic function | symbolic expression

Input, specified as a number, vector, matrix, or multidimensional array, or a symbolic number, variable, vector, matrix, multidimensional array, function, or expression.

m – Input

number | vector | matrix | multidimensional array | symbolic number | symbolic variable | symbolic vector | symbolic matrix | symbolic multidimensional array | symbolic function | symbolic expression

Input, specified as a number, vector, matrix, or multidimensional array, or a symbolic number, variable, vector, matrix, multidimensional array, function, or expression.

More About

Jacobi CS Elliptic Function

The Jacobi CS elliptic function is

$$cs(u,m) = cn(u,m)/sn(u,m)$$

where cn and sn are the respective Jacobi elliptic functions.

The Jacobi elliptic functions are meromorphic and doubly periodic in their first argument with periods $4K(m)$ and $4iK'(m)$, where K is the complete elliptic integral of the first kind, implemented as `ellipticK`.

See Also

`ellipticK` | `jacobiAM` | `jacobiCD` | `jacobiCN` | `jacobiDC` | `jacobiDN` | `jacobiDS` | `jacobiNC` | `jacobiND` | `jacobiNS` | `jacobiSC` | `jacobiSD` | `jacobiSN` | `jacobiZeta`

Introduced in R2017b

jacobiDC

Jacobi DC elliptic function

Syntax

```
jacobiDC(u,m)
```

Description

`jacobiDC(u,m)` returns the “Jacobi DC Elliptic Function” on page 4-814 of `u` and `m`. If `u` or `m` is an array, then `jacobiDC` acts element-wise.

Examples

Calculate Jacobi DC Elliptic Function for Numeric Inputs

```
jacobiDC(2,1)
```

```
ans =
     1
```

Call `jacobiDC` on array inputs. `jacobiDC` acts element-wise when `u` or `m` is an array.

```
jacobiDC([2 1 -3],[1 2 3])
```

```
ans =
     1.0000     0.4197    -0.0056
```

Calculate Jacobi DC Elliptic Function for Symbolic Numbers

Convert numeric input to symbolic form using `sym`, and find the Jacobi DC elliptic function. For symbolic input where `u = 0` or `m = 0` or `1`, `jacobiDC` returns exact symbolic output.

```
jacobiDC(sym(2),sym(1))
```

```
ans =
     1
```

Show that for other values of `u` or `m`, `jacobiDC` returns an unevaluated function call.

```
jacobiDC(sym(2),sym(3))
```

```
ans =
jacobiDC(2, 3)
```

Find Jacobi DC Elliptic Function for Symbolic Variables or Expressions

For symbolic variables or expressions, `jacobiDC` returns the unevaluated function call.

```
syms x y
f = jacobiDC(x,y)
```

```
f =
jacobiDC(x, y)
```

Substitute values for the variables by using `subs`, and convert values to double by using `double`.

```
f = subs(f, [x y], [3 5])
```

```
f =
jacobiDC(3, 5)
```

```
fVal = double(f)
```

```
fVal =
    0.9981
```

Calculate `f` to higher precision using `vpa`.

```
fVal = vpa(f)
```

```
fVal =
0.99805623285568333815968501058428
```

Plot Jacobi DC Elliptic Function

Plot the Jacobi DC elliptic function using `fcontour`. Set `u` on the x-axis and `m` on the y-axis by using the symbolic function `f` with the variable order `(u,m)`. Fill plot contours by setting `Fill` to `on`.

```
syms f(u,m)
f(u,m) = jacobiDC(u,m);
fcontour(f,'Fill','on')
title('Jacobi DC Elliptic Function')
xlabel('u')
ylabel('m')
```

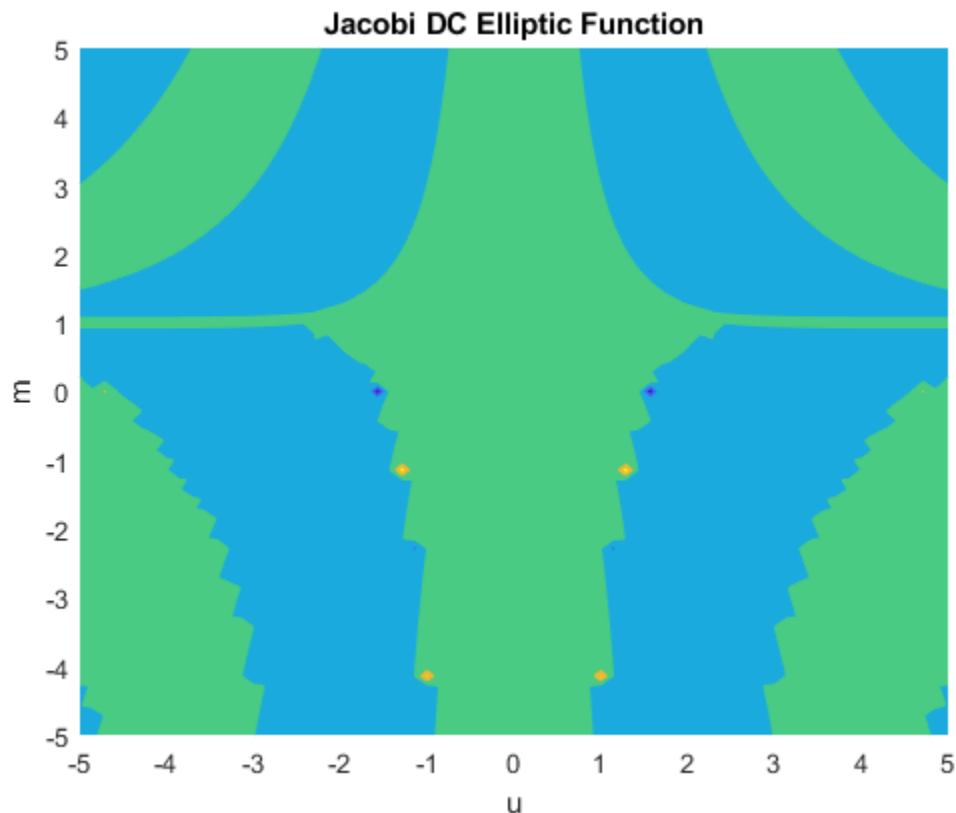

Input Arguments

u – Input

number | vector | matrix | multidimensional array | symbolic number | symbolic variable | symbolic vector | symbolic matrix | symbolic multidimensional array | symbolic function | symbolic expression

Input, specified as a number, vector, matrix, or multidimensional array, or a symbolic number, variable, vector, matrix, multidimensional array, function, or expression.

m – Input

number | vector | matrix | multidimensional array | symbolic number | symbolic variable | symbolic vector | symbolic matrix | symbolic multidimensional array | symbolic function | symbolic expression

Input, specified as a number, vector, matrix, or multidimensional array, or a symbolic number, variable, vector, matrix, multidimensional array, function, or expression.

More About

Jacobi DC Elliptic Function

The Jacobi DC elliptic function is

$$dc(u,m) = dn(u,m)/cn(u,m)$$

where dn and cn are the respective Jacobi elliptic functions.

The Jacobi elliptic functions are meromorphic and doubly periodic in their first argument with periods $4K(m)$ and $4iK'(m)$, where K is the complete elliptic integral of the first kind, implemented as `elliptick`.

See Also

`elliptick` | `jacobiAM` | `jacobiCD` | `jacobiCN` | `jacobiCS` | `jacobiDN` | `jacobiDS` | `jacobiNC` | `jacobiND` | `jacobiNS` | `jacobiSC` | `jacobiSD` | `jacobiSN` | `jacobiZeta`

Introduced in R2017b

jacobiDN

Jacobi DN elliptic function

Syntax

```
jacobiDN(u,m)
```

Description

`jacobiDN(u,m)` returns the “Jacobi DN Elliptic Function” on page 4-817 of `u` and `m`. If `u` or `m` is an array, then `jacobiDN` acts element-wise.

Examples

Calculate Jacobi DN Elliptic Function for Numeric Inputs

```
jacobiDN(2,1)
```

```
ans =
    0.2658
```

Call `jacobiDN` on array inputs. `jacobiDN` acts element-wise when `u` or `m` is an array.

```
jacobiDN([2 1 -3],[1 2 3])
```

```
ans =
    0.2658    0.3107   -0.0046
```

Calculate Jacobi DN Elliptic Function for Symbolic Numbers

Convert numeric input to symbolic form using `sym`, and find the Jacobi DN elliptic function. For symbolic input where `u = 0` or `m = 0` or `1`, `jacobiDN` returns exact symbolic output.

```
jacobiDN(sym(2),sym(1))
```

```
ans =
1/cosh(2)
```

Show that for other values of `u` or `m`, `jacobiDN` returns an unevaluated function call.

```
jacobiDN(sym(2),sym(3))
```

```
ans =
jacobiDN(2, 3)
```

Find Jacobi DN Elliptic Function for Symbolic Variables or Expressions

For symbolic variables or expressions, `jacobiDN` returns the unevaluated function call.

```
syms x y
f = jacobiDN(x,y)
```

```
f =
jacobiDN(x, y)
```

Substitute values for the variables by using `subs`, and convert values to double by using `double`.

```
f = subs(f, [x y], [3 5])
```

```
f =  
jacobiDN(3, 5)
```

```
fVal = double(f)
```

```
fVal =  
    0.9976
```

Calculate `f` to higher precision using `vpa`.

```
fVal = vpa(f)
```

```
fVal =  
0.99757205953668099307853539907267
```

Plot Jacobi DN Elliptic Function

Plot the Jacobi DN elliptic function using `fcontour`. Set `u` on the x-axis and `m` on the y-axis by using the symbolic function `f` with the variable order `(u,m)`. Fill plot contours by setting `Fill` to `on`.

```
syms f(u,m)  
f(u,m) = jacobiDN(u,m);  
fcontour(f, 'Fill', 'on')  
title('Jacobi DN Elliptic Function')  
xlabel('u')  
ylabel('m')
```

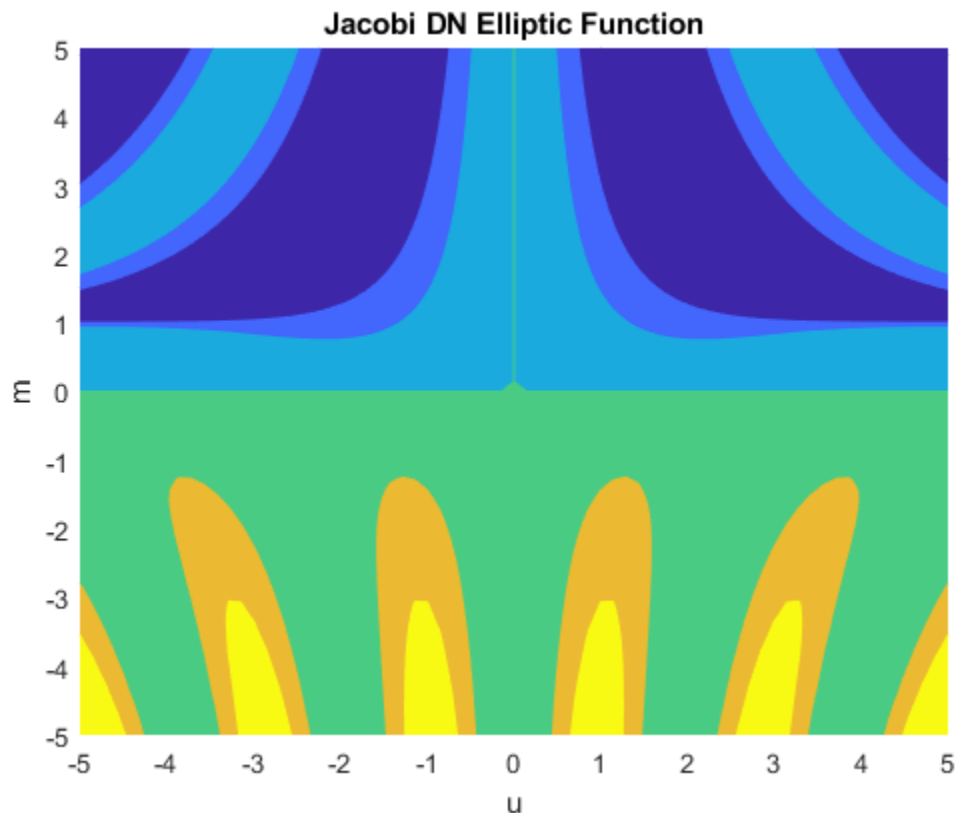

Input Arguments

u – Input

number | vector | matrix | multidimensional array | symbolic number | symbolic variable | symbolic vector | symbolic matrix | symbolic multidimensional array | symbolic function | symbolic expression

Input, specified as a number, vector, matrix, or multidimensional array, or a symbolic number, variable, vector, matrix, multidimensional array, function, or expression.

m – Input

number | vector | matrix | multidimensional array | symbolic number | symbolic variable | symbolic vector | symbolic matrix | symbolic multidimensional array | symbolic function | symbolic expression

Input, specified as a number, vector, matrix, or multidimensional array, or a symbolic number, variable, vector, matrix, multidimensional array, function, or expression.

More About

Jacobi DN Elliptic Function

The Jacobi DN elliptic function is

$$\operatorname{dn}(u, m) = \sqrt{1 - m \sin(\phi)^2}$$

where ϕ is such that $F(\phi, m) = u$ and F represents the incomplete elliptic integral of the first kind. F is implemented as `ellipticF`.

The Jacobi elliptic functions are meromorphic and doubly periodic in their first argument with periods $4K(m)$ and $4iK'(m)$, where K is the complete elliptic integral of the first kind, implemented as `ellipticK`.

See Also

`ellipticK` | `jacobiAM` | `jacobiCD` | `jacobiCN` | `jacobiCS` | `jacobiDC` | `jacobiDS` | `jacobiNC` | `jacobiND` | `jacobiNS` | `jacobiSC` | `jacobiSD` | `jacobiSN` | `jacobiZeta`

Introduced in R2017b

jacobiDS

Jacobi DS elliptic function

Syntax

```
jacobiDS(u,m)
```

Description

`jacobiDS(u,m)` returns the “Jacobi DS Elliptic Function” on page 4-820 of `u` and `m`. If `u` or `m` is an array, then `jacobiDS` acts element-wise.

Examples

Calculate Jacobi DS Elliptic Function for Numeric Inputs

```
jacobiDS(2,1)
```

```
ans =  
    0.2757
```

Call `jacobiDS` on array inputs. `jacobiDS` acts element-wise when `u` or `m` is an array.

```
jacobiDS([2 1 -3],[1 2 3])
```

```
ans =  
    0.2757    0.4623   -0.0079
```

Calculate Jacobi DS Elliptic Function for Symbolic Numbers

Convert numeric input to symbolic form using `sym`, and find the Jacobi DS elliptic function. For symbolic input where `u = 0` or `m = 0` or `1`, `jacobiDS` returns exact symbolic output.

```
jacobiDS(sym(2),sym(1))
```

```
ans =  
1/sinh(2)
```

Show that for other values of `u` or `m`, `jacobiDS` returns an unevaluated function call.

```
jacobiDS(sym(2),sym(3))
```

```
ans =  
jacobiDS(2, 3)
```

Find Jacobi DS Elliptic Function for Symbolic Variables or Expressions

For symbolic variables or expressions, `jacobiDS` returns the unevaluated function call.

```
syms x y  
f = jacobiDS(x,y)
```

```
f =  
jacobiDS(x, y)
```

Substitute values for the variables by using `subs`, and convert values to double by using `double`.

```
f = subs(f, [x y], [3 5])
```

```
f =
jacobiDS(3, 5)
```

```
fVal = double(f)
```

```
fVal =
    32.0302
```

Calculate `f` to higher precision using `vpa`.

```
fVal = vpa(f)
```

```
fVal =
32.030154607596772037587224629884
```

Plot Jacobi DS Elliptic Function

Plot the Jacobi DS elliptic function using `fcontour`. Set `u` on the x-axis and `m` on the y-axis by using the symbolic function `f` with the variable order `(u,m)`. Fill plot contours by setting `Fill` to `on`.

```
syms f(u,m)
f(u,m) = jacobiDS(u,m);
fcontour(f,'Fill','on')
title('Jacobi DS Elliptic Function')
xlabel('u')
ylabel('m')
```

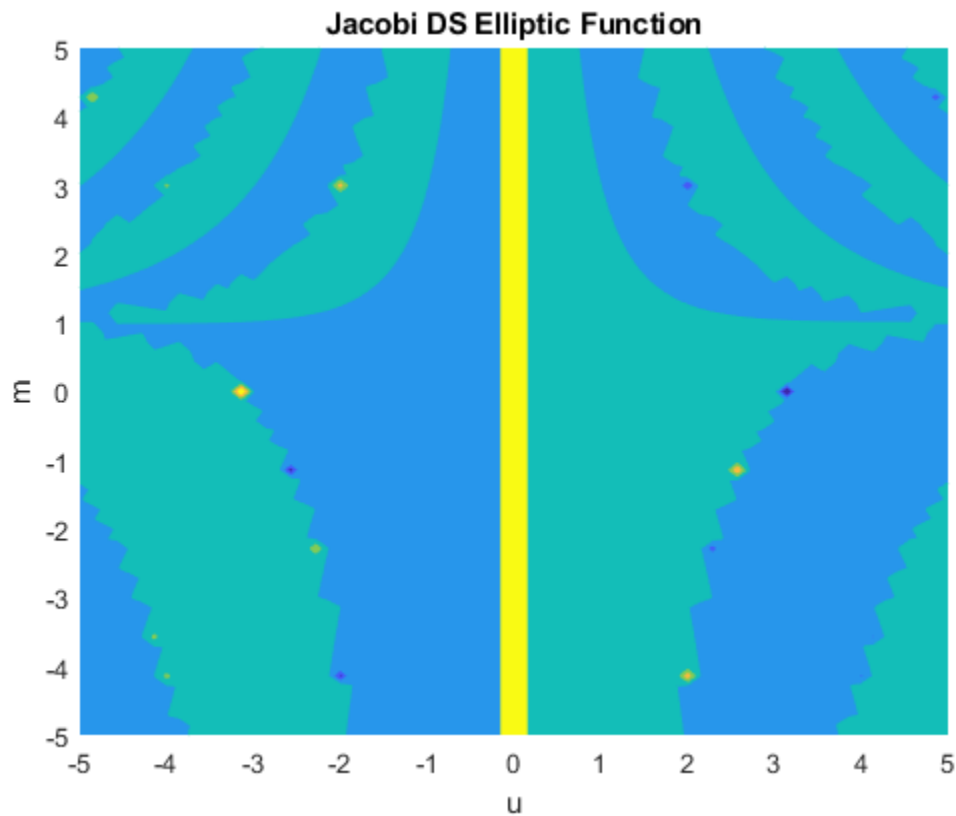

Input Arguments

u – Input

number | vector | matrix | multidimensional array | symbolic number | symbolic variable | symbolic vector | symbolic matrix | symbolic multidimensional array | symbolic function | symbolic expression

Input, specified as a number, vector, matrix, or multidimensional array, or a symbolic number, variable, vector, matrix, multidimensional array, function, or expression.

m – Input

number | vector | matrix | multidimensional array | symbolic number | symbolic variable | symbolic vector | symbolic matrix | symbolic multidimensional array | symbolic function | symbolic expression

Input, specified as a number, vector, matrix, or multidimensional array, or a symbolic number, variable, vector, matrix, multidimensional array, function, or expression.

More About

Jacobi DS Elliptic Function

The Jacobi DS elliptic function is

$$ds(u,m) = dn(u,m)/sn(u,m)$$

where dn and sn are the respective Jacobi elliptic functions.

The Jacobi elliptic functions are meromorphic and doubly periodic in their first argument with periods $4K(m)$ and $4iK'(m)$, where K is the complete elliptic integral of the first kind, implemented as `elliptick`.

See Also

`elliptick` | `jacobiAM` | `jacobiCD` | `jacobiCN` | `jacobiCS` | `jacobiDC` | `jacobiDN` | `jacobiNC` | `jacobiND` | `jacobiNS` | `jacobiSC` | `jacobiSD` | `jacobiSN` | `jacobiZeta`

Introduced in R2017b

jacobiNC

Jacobi NC elliptic function

Syntax

```
jacobiNC(u,m)
```

Description

`jacobiNC(u,m)` returns the “Jacobi NC Elliptic Function” on page 4-823 of `u` and `m`. If `u` or `m` is an array, then `jacobiNC` acts element-wise.

Examples

Calculate Jacobi NC Elliptic Function for Numeric Inputs

```
jacobiNC(2,1)
```

```
ans =
    3.7622
```

Call `jacobiNC` on array inputs. `jacobiNC` acts element-wise when `u` or `m` is an array.

```
jacobiNC([2 1 -3],[1 2 3])
```

```
ans =
    3.7622    1.3505    1.2247
```

Calculate Jacobi NC Elliptic Function for Symbolic Numbers

Convert numeric input to symbolic form using `sym`, and find the Jacobi NC elliptic function. For symbolic input where `u = 0` or `m = 0` or `1`, `jacobiNC` returns exact symbolic output.

```
jacobiNC(sym(2),sym(1))
```

```
ans =
cosh(2)
```

Show that for other values of `u` or `m`, `jacobiNC` returns an unevaluated function call.

```
jacobiNC(sym(2),sym(3))
```

```
ans =
jacobiNC(2, 3)
```

Find Jacobi NC Elliptic Function for Symbolic Variables or Expressions

For symbolic variables or expressions, `jacobiNC` returns the unevaluated function call.

```
syms x y
f = jacobiNC(x,y)
```

```
f =
jacobiNC(x, y)
```

Substitute values for the variables by using `subs`, and convert values to double by using `double`.

```
f = subs(f, [x y], [3 5])
```

```
f =
jacobiNC(3, 5)
```

```
fVal = double(f)
```

```
fVal =
    1.0005
```

Calculate `f` to higher precision using `vpa`.

```
fVal = vpa(f)
```

```
fVal =
1.0004853517240922102007985618873
```

Plot Jacobi NC Elliptic Function

Plot the Jacobi NC elliptic function using `fcontour`. Set `u` on the x-axis and `m` on the y-axis by using the symbolic function `f` with the variable order `(u,m)`. Fill plot contours by setting `Fill` to `on`.

```
syms f(u,m)
f(u,m) = jacobiNC(u,m);
fcontour(f, 'Fill', 'on')
title('Jacobi NC Elliptic Function')
xlabel('u')
ylabel('m')
```

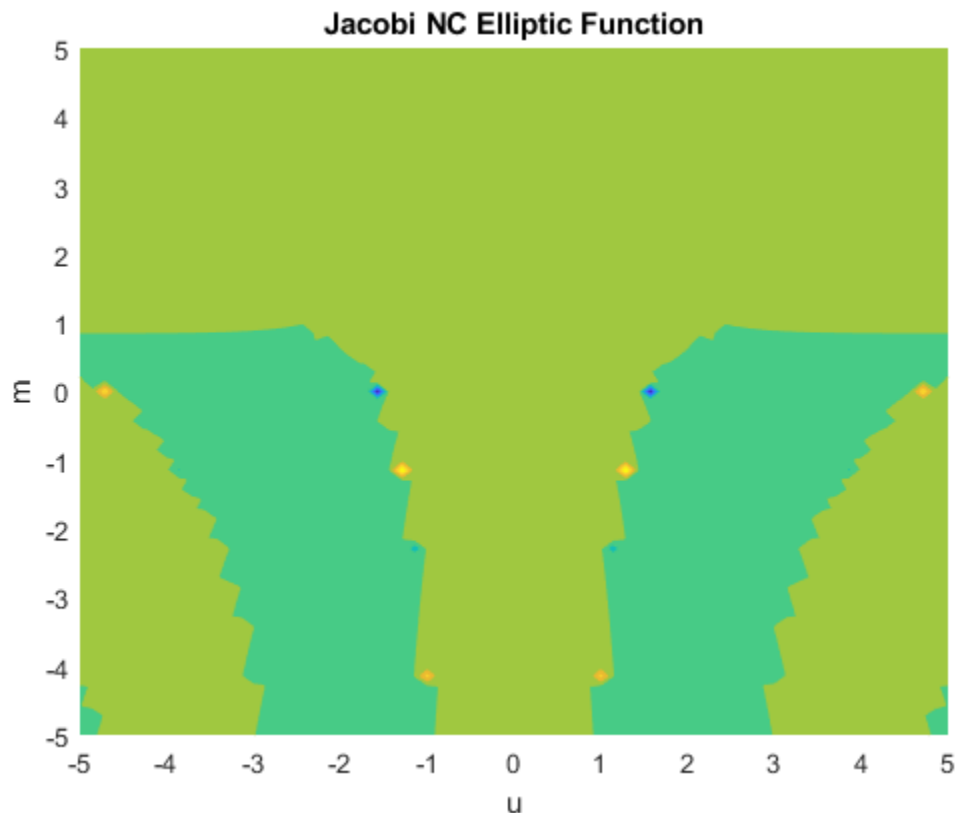

Input Arguments

u – Input

number | vector | matrix | multidimensional array | symbolic number | symbolic variable | symbolic vector | symbolic matrix | symbolic multidimensional array | symbolic function | symbolic expression

Input, specified as a number, vector, matrix, or multidimensional array, or a symbolic number, variable, vector, matrix, multidimensional array, function, or expression.

m – Input

number | vector | matrix | multidimensional array | symbolic number | symbolic variable | symbolic vector | symbolic matrix | symbolic multidimensional array | symbolic function | symbolic expression

Input, specified as a number, vector, matrix, or multidimensional array, or a symbolic number, variable, vector, matrix, multidimensional array, function, or expression.

More About

Jacobi NC Elliptic Function

The Jacobi NC elliptic function is

$$\text{nc}(u,m) = 1/\text{cn}(u,m)$$

where cn is the respective Jacobi elliptic function.

The Jacobi elliptic functions are meromorphic and doubly periodic in their first argument with periods $4K(m)$ and $4iK'(m)$, where K is the complete elliptic integral of the first kind, implemented as `ellipticK`.

See Also

`ellipticK` | `jacobiAM` | `jacobiCD` | `jacobiCN` | `jacobiCS` | `jacobiDC` | `jacobiDN` | `jacobiDS` | `jacobiND` | `jacobiNS` | `jacobiSC` | `jacobiSD` | `jacobiSN` | `jacobiZeta`

Introduced in R2017b

jacobiND

Jacobi ND elliptic function

Syntax

```
jacobiND(u,m)
```

Description

`jacobiND(u,m)` returns the “Jacobi ND Elliptic Function” on page 4-826 of `u` and `m`. If `u` or `m` is an array, then `jacobiND` acts element-wise.

Examples

Calculate Jacobi ND Elliptic Function for Numeric Inputs

```
jacobiND(2,1)
```

```
ans =  
    3.7622
```

Call `jacobiND` on array inputs. `jacobiND` acts element-wise when `u` or `m` is an array.

```
jacobiND([2 1 -3],[1 2 3])
```

```
ans =  
    3.7622    3.2181 -218.7739
```

Calculate Jacobi ND Elliptic Function for Symbolic Numbers

Convert numeric input to symbolic form using `sym`, and find the Jacobi ND elliptic function. For symbolic input where `u = 0` or `m = 0` or `1`, `jacobiND` returns exact symbolic output.

```
jacobiND(sym(2),sym(1))
```

```
ans =  
cosh(2)
```

Show that for other values of `u` or `m`, `jacobiND` returns an unevaluated function call.

```
jacobiND(sym(2),sym(3))
```

```
ans =  
jacobiND(2, 3)
```

Find Jacobi ND Elliptic Function for Symbolic Variables or Expressions

For symbolic variables or expressions, `jacobiND` returns the unevaluated function call.

```
syms x y  
f = jacobiND(x,y)
```

```
f =  
jacobiND(x, y)
```

Substitute values for the variables by using `subs`, and convert values to double by using `double`.

```
f = subs(f, [x y], [3 5])
```

```
f =
jacobiND(3, 5)
```

```
fVal = double(f)
```

```
fVal =
    1.0024
```

Calculate `f` to higher precision using `vpa`.

```
fVal = vpa(f)
```

```
fVal =
1.0024338497055006289470589737758
```

Plot Jacobi ND Elliptic Function

Plot the Jacobi ND elliptic function using `fcontour`. Set `u` on the x-axis and `m` on the y-axis by using the symbolic function `f` with the variable order `(u,m)`. Fill plot contours by setting `Fill` to `on`.

```
syms f(u,m)
f(u,m) = jacobiND(u,m);
fcontour(f,'Fill','on')
title('Jacobi ND Elliptic Function')
xlabel('u')
ylabel('m')
```

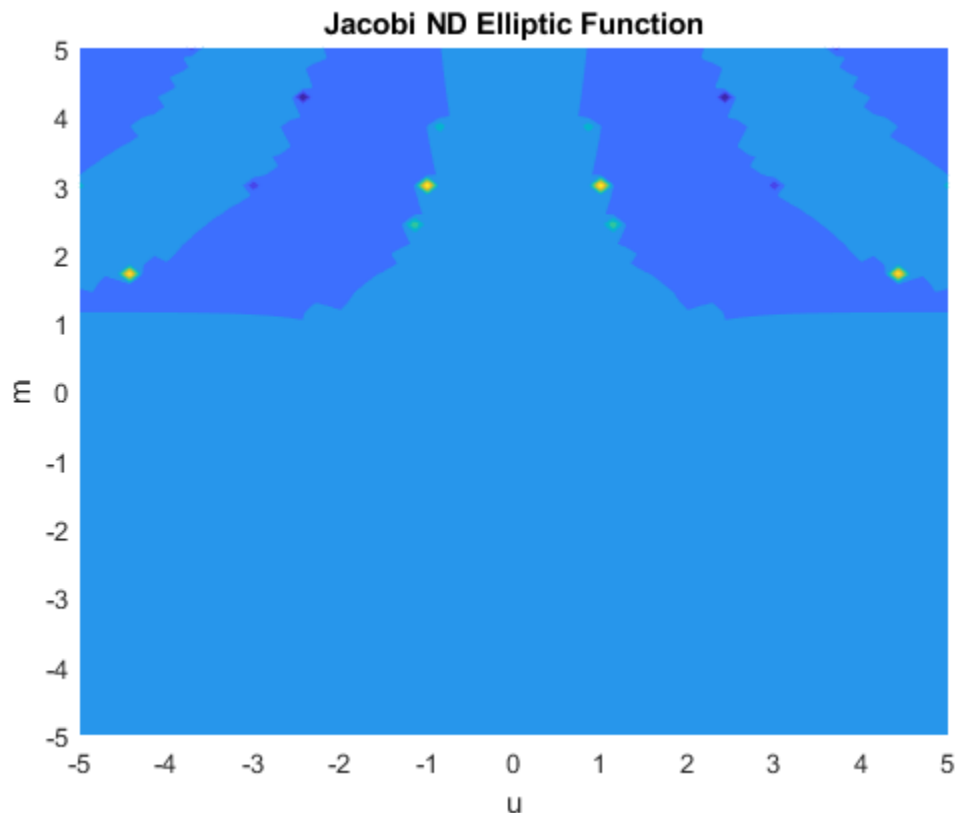

Input Arguments

u – Input

number | vector | matrix | multidimensional array | symbolic number | symbolic variable | symbolic vector | symbolic matrix | symbolic multidimensional array | symbolic function | symbolic expression

Input, specified as a number, vector, matrix, or multidimensional array, or a symbolic number, variable, vector, matrix, multidimensional array, function, or expression.

m – Input

number | vector | matrix | multidimensional array | symbolic number | symbolic variable | symbolic vector | symbolic matrix | symbolic multidimensional array | symbolic function | symbolic expression

Input, specified as a number, vector, matrix, or multidimensional array, or a symbolic number, variable, vector, matrix, multidimensional array, function, or expression.

More About

Jacobi ND Elliptic Function

The Jacobi ND elliptic function is

$$\text{nd}(u,m) = 1/\text{dn}(u,m)$$

where dn is the respective Jacobi elliptic function.

The Jacobi elliptic functions are meromorphic and doubly periodic in their first argument with periods $4K(m)$ and $4iK'(m)$, where K is the complete elliptic integral of the first kind, implemented as `elliptick`.

See Also

`elliptick` | `jacobiAM` | `jacobiCD` | `jacobiCN` | `jacobiCS` | `jacobiDC` | `jacobiDN` | `jacobiDS` | `jacobiNC` | `jacobiNS` | `jacobiSC` | `jacobiSD` | `jacobiSN` | `jacobiZeta`

Introduced in R2017b

jacobiNS

Jacobi NS elliptic function

Syntax

```
jacobiNS(u,m)
```

Description

`jacobiNS(u,m)` returns the “Jacobi NS Elliptic Function” on page 4-829 of `u` and `m`. If `u` or `m` is an array, then `jacobiNS` acts element-wise.

Examples

Calculate Jacobi NS Elliptic Function for Numeric Inputs

```
jacobiNS(2,1)
```

```
ans =
    1.0373
```

Call `jacobiNS` on array inputs. `jacobiNS` acts element-wise when `u` or `m` is an array.

```
jacobiNS([2 1 -3],[1 2 3])
```

```
ans =
    1.0373    1.4879    1.7321
```

Calculate Jacobi NS Elliptic Function for Symbolic Numbers

Convert numeric input to symbolic form using `sym`, and find the Jacobi NS elliptic function. For symbolic input where `u = 0` or `m = 0` or `1`, `jacobiNS` returns exact symbolic output.

```
jacobiNS(sym(2),sym(1))
```

```
ans =
coth(2)
```

Show that for other values of `u` or `m`, `jacobiNS` returns an unevaluated function call.

```
jacobiNS(sym(2),sym(3))
```

```
ans =
jacobiNS(2, 3)
```

Find Jacobi NS Elliptic Function for Symbolic Variables or Expressions

For symbolic variables or expressions, `jacobiNS` returns the unevaluated function call.

```
syms x y
f = jacobiNS(x,y)
```

```
f =
jacobiNS(x, y)
```

Substitute values for the variables by using `subs`, and convert values to double by using `double`.

```
f = subs(f, [x y], [3 5])
```

```
f =
jacobiNS(3, 5)
```

```
fVal = double(f)
```

```
fVal =
    32.1081
```

Calculate `f` to higher precision using `vpa`.

```
fVal = vpa(f)
```

```
fVal =
32.1081111189955611054545195854805
```

Plot Jacobi NS Elliptic Function

Plot the Jacobi NS elliptic function using `fcontour`. Set `u` on the x-axis and `m` on the y-axis by using the symbolic function `f` with the variable order `(u,m)`. Fill plot contours by setting `Fill` to `on`.

```
syms f(u,m)
f(u,m) = jacobiNS(u,m);
fcontour(f, 'Fill', 'on')
title('Jacobi NS Elliptic Function')
xlabel('u')
ylabel('m')
```

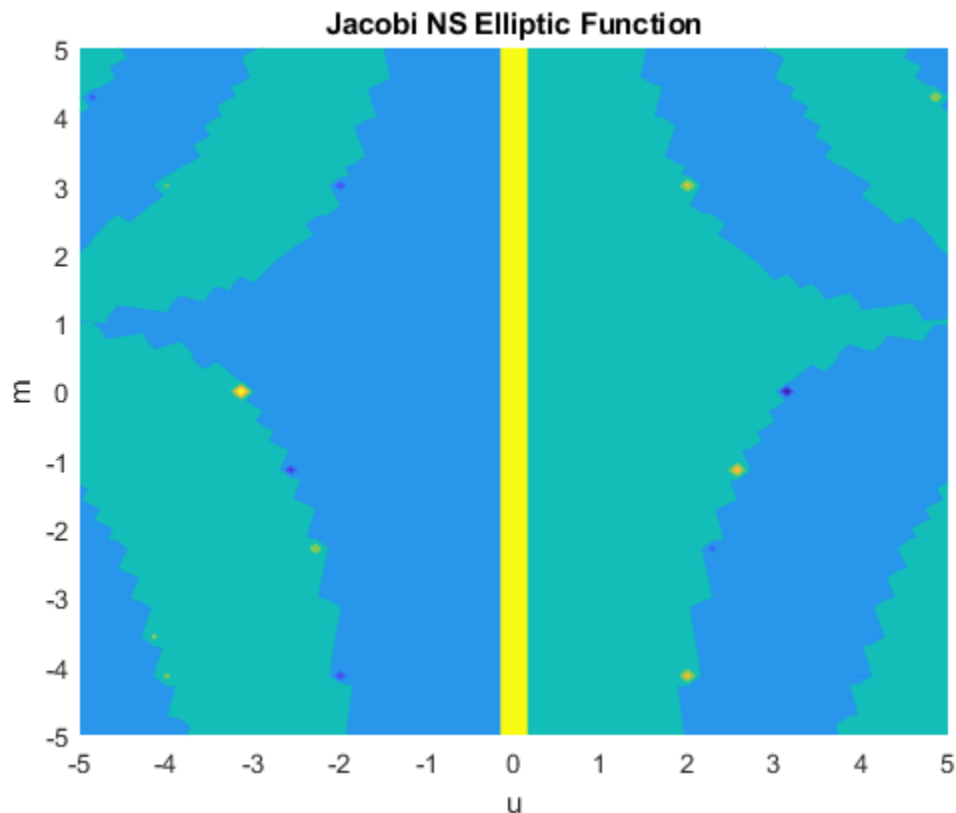

Input Arguments

u – Input

number | vector | matrix | multidimensional array | symbolic number | symbolic variable | symbolic vector | symbolic matrix | symbolic multidimensional array | symbolic function | symbolic expression

Input, specified as a number, vector, matrix, or multidimensional array, or a symbolic number, variable, vector, matrix, multidimensional array, function, or expression.

m – Input

number | vector | matrix | multidimensional array | symbolic number | symbolic variable | symbolic vector | symbolic matrix | symbolic multidimensional array | symbolic function | symbolic expression

Input, specified as a number, vector, matrix, or multidimensional array, or a symbolic number, variable, vector, matrix, multidimensional array, function, or expression.

More About

Jacobi NS Elliptic Function

The Jacobi NS elliptic function is

$$ns(u,m) = 1/ds(u,m)$$

where ds is the respective Jacobi elliptic function.

The Jacobi elliptic functions are meromorphic and doubly periodic in their first argument with periods $4K(m)$ and $4iK'(m)$, where K is the complete elliptic integral of the first kind, implemented as `ellipticK`.

See Also

`ellipticK` | `jacobiAM` | `jacobiCD` | `jacobiCN` | `jacobiCS` | `jacobiDC` | `jacobiDN` | `jacobiDS` | `jacobiNC` | `jacobiND` | `jacobiSC` | `jacobiSD` | `jacobiSN` | `jacobiZeta`

Introduced in R2017b

jacobiP

Jacobi polynomials

Syntax

```
jacobiP(n,a,b,x)
```

Description

`jacobiP(n,a,b,x)` returns the n th degree Jacobi polynomial on page 4-833 with parameters a and b at x .

Examples

Find Jacobi Polynomials for Numeric and Symbolic Inputs

Find the Jacobi polynomial of degree 2 for numeric inputs.

```
jacobiP(2,0.5,-3,6)
```

```
ans =  
    7.3438
```

Find the Jacobi polynomial for symbolic inputs.

```
syms n a b x  
jacobiP(n,a,b,x)
```

```
ans =  
jacobiP(n, a, b, x)
```

If the degree of the Jacobi polynomial is not specified, `jacobiP` cannot find the polynomial and returns the function call.

Specify the degree of the Jacobi polynomial as 1 to return the form of the polynomial.

```
J = jacobiP(1,a,b,x)
```

```
J =  
a/2 - b/2 + x*(a/2 + b/2 + 1)
```

To find the numeric value of a Jacobi polynomial, call `jacobiP` with the numeric values directly. Do not substitute into the symbolic polynomial because the result can be inaccurate due to round-off. Test this by using `subs` to substitute into the symbolic polynomial, and compare the result with a numeric call.

```
J = jacobiP(300, -1/2, -1/2, x);  
subs(J,x,vpa(1/2))  
jacobiP(300, -1/2, -1/2, vpa(1/2))
```

```
ans =  
101573673381249394050.64541318209
```

```
ans =
0.032559931334979678350422392588404
```

When subs is used to substitute into the symbolic polynomial, the numeric result is subject to round-off error. The direct numerical call to jacobiP is accurate.

Find Jacobi Polynomial with Vector and Matrix Inputs

Find the Jacobi polynomials of degrees 1 and 2 by setting $n = [1 \ 2]$ for $a = 3$ and $b = 1$.

```
syms x
jacobiP([1 2],3,1,x)

ans =
[ 3*x + 1, 7*x^2 + (7*x)/2 - 1/2]
```

`jacobiP` acts on n element-wise to return a vector with two entries.

If multiple inputs are specified as a vector, matrix, or multidimensional array, these inputs must be the same size. Find the Jacobi polynomials for $a = [1 \ 2; 3 \ 1]$, $b = [2 \ 2; 1 \ 3]$, $n = 1$ and x .

```
a = [1 2;3 1];
b = [2 2;1 3];
J = jacobiP(1,a,b,x)

J =
[ (5*x)/2 - 1/2, 3*x]
[ 3*x + 1, 3*x - 1]
```

`jacobiP` acts element-wise on a and b to return a matrix of the same size as a and b .

Visualize Zeros of Jacobi Polynomials

Plot Jacobi polynomials of degree 1, 2, and 3 for $a = 3$, $b = 3$, and $-1 < x < 1$. To better view the plot, set axis limits by using `axis`.

```
syms x
fplot(jacobiP(1:3,3,3,x))
axis([-1 1 -2 2])
grid on

ylabel('P_n^{(\alpha,\beta)}(x)')
title('Zeros of Jacobi polynomials of degree=1,2,3 with a=3 and b=3');
legend('1','2','3','Location','best')
```

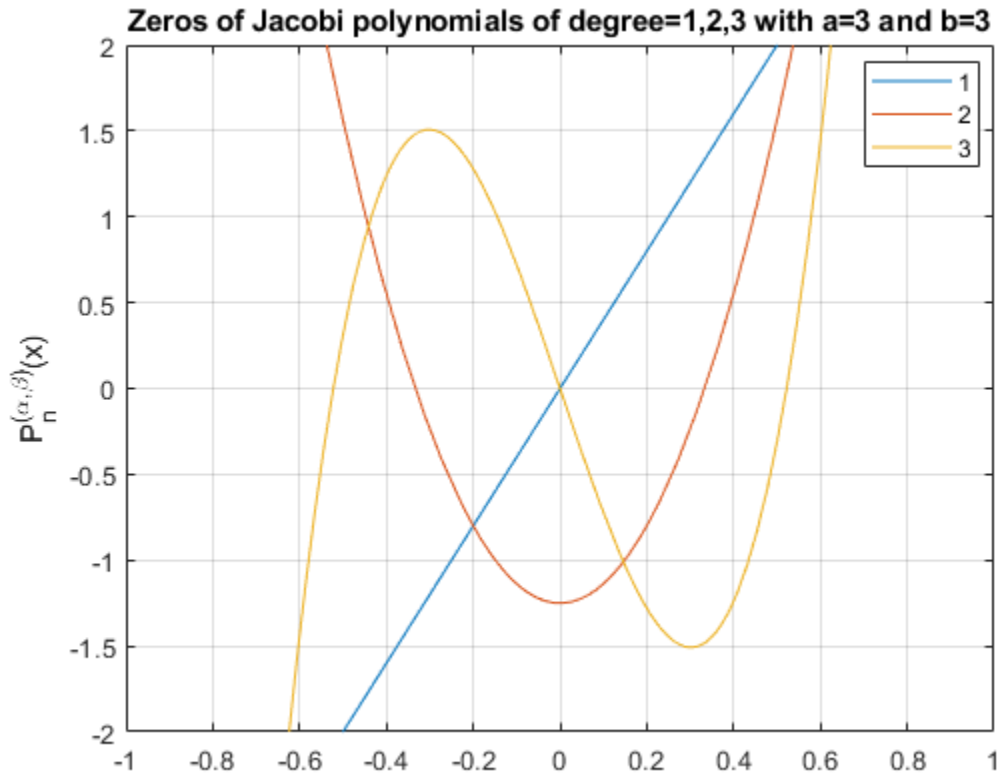

Prove Orthogonality of Jacobi Polynomials with Respect to Weight Function

The Jacobi polynomials $P(n,a,b,x)$ are orthogonal with respect to the weight function $(1-x)^a(1+x)^b$ on the interval $[-1, 1]$.

Prove $P(3,a,b,x)$ and $P(5,a,b,x)$ are orthogonal with respect to the weight function $(1-x)^a(1+x)^b$ by integrating their product over the interval $[-1, 1]$, where $a = 3.5$ and $b = 7.2$.

```
syms x
a = 3.5;
b = 7.2;
P3 = jacobiP(3, a, b, x);
P5 = jacobiP(5, a, b, x);
w = (1-x)^a*(1+x)^b;
int(P3*P5*w, x, -1, 1)
```

```
ans =
0
```

Input Arguments

n — Degree of Jacobi polynomial

nonnegative integer | vector of nonnegative integers | matrix of nonnegative integers | multidimensional array of nonnegative integers | symbolic nonnegative integer | symbolic variable |

symbolic vector | symbolic matrix | symbolic function | symbolic expression | symbolic multidimensional array

Degree of Jacobi polynomial, specified as a nonnegative integer, or a vector, matrix, or multidimensional array of nonnegative integers, or a symbolic nonnegative integer, variable, vector, matrix, function, expression, or multidimensional array.

a – Input

number | vector | matrix | multidimensional array | symbolic number | symbolic vector | symbolic matrix | symbolic function | symbolic expression | symbolic multidimensional array

Input, specified as a number, vector, matrix, multidimensional array, or a symbolic number, vector, matrix, function, expression, or multidimensional array.

b – Input

number | vector | matrix | multidimensional array | symbolic number | symbolic vector | symbolic matrix | symbolic function | symbolic expression | symbolic multidimensional array

Input, specified as a number, vector, matrix, multidimensional array, or a symbolic number, vector, matrix, function, expression, or multidimensional array.

x – Evaluation point

number | vector | matrix | multidimensional array | symbolic number | symbolic vector | symbolic matrix | symbolic function | symbolic expression | symbolic multidimensional array

Evaluation point, specified as a number, vector, matrix, multidimensional array, or a symbolic number, vector, matrix, function, expression, or multidimensional array.

More About

Jacobi Polynomials

- The Jacobi polynomials are given by the recursion formula

$$2nc_n c_{2n-2} P(n, a, b, x) = c_{2n-1} (c_{2n-2} c_{2n} x + a^2 - b^2) P(n-1, a, b, x) - 2(n-1+a)(n-1+b) c_{2n} P(n-2, a, b, x),$$

where

$$c_n = n + a + b$$

$$P(0, a, b, x) = 1$$

$$P(1, a, b, x) = \frac{a-b}{2} + \left(1 + \frac{a+b}{2}\right)x.$$

- For fixed real $a > -1$ and $b > -1$, the Jacobi polynomials are orthogonal on the interval $[-1, 1]$ with respect to the weight function $w(x) = (1-x)^a(1+x)^b$.

$$\int_{-1}^1 P(n, a, b, x) P(m, a, b, x) (1-x)^a (1+x)^b dx = \begin{cases} 0 & \text{if } n \neq m \\ \frac{2^{a+b+1}}{2n+a+b+1} \frac{\Gamma(n+a+1)\Gamma(n+b+1)}{\Gamma(n+a+b+1)n!} & \text{if } n = m. \end{cases}$$

- For $a = 0$ and $b = 0$, the Jacobi polynomials $P(n, 0, 0, x)$ reduce to the Legendre polynomials $P(n, x)$.
- The relation between Jacobi polynomials $P(n, a, b, x)$ and Chebyshev polynomials of the first kind $T(n, x)$ is

$$T(n, x) = \frac{2^{2n}(n!)^2}{(2n)!} P\left(n, -\frac{1}{2}, -\frac{1}{2}, x\right).$$

- The relation between Jacobi polynomials $P(n, a, b, x)$ and Chebyshev polynomials of the second kind $U(n, x)$ is

$$U(n, x) = \frac{2^{2n}n!(n+1)!}{(2n+1)!} P\left(n, \frac{1}{2}, \frac{1}{2}, x\right).$$

- The relation between Jacobi polynomials $P(n, a, b, x)$ and Gegenbauer polynomials $G(n, a, x)$ is

$$G(n, a, x) = \frac{\Gamma\left(a + \frac{1}{2}\right)\Gamma(n + 2a)}{\Gamma(2a)\Gamma\left(n + a + \frac{1}{2}\right)} P\left(n, a - \frac{1}{2}, a - \frac{1}{2}, x\right).$$

See Also

[chebyshevT](#) | [chebyshevU](#) | [gegenbauerC](#) | [hermiteH](#) | [hypergeom](#) | [laguerreL](#) | [legendreP](#)

Introduced in R2014b

jacobiSC

Jacobi SC elliptic function

Syntax

```
jacobiSC(u,m)
```

Description

`jacobiSC(u,m)` returns the “Jacobi SC Elliptic Function” on page 4-837 of `u` and `m`. If `u` or `m` is an array, then `jacobiSC` acts element-wise.

Examples

Calculate Jacobi SC Elliptic Function for Numeric Inputs

```
jacobiSC(2,1)
```

```
ans =
    3.6269
```

Call `jacobiSC` on array inputs. `jacobiSC` acts element-wise when `u` or `m` is an array.

```
jacobiSC([2 1 -3],[1 2 3])
```

```
ans =
    3.6269    0.9077    0.7071
```

Calculate Jacobi SC Elliptic Function for Symbolic Numbers

Convert numeric input to symbolic form using `sym`, and find the Jacobi SC elliptic function. For symbolic input where `u = 0` or `m = 0` or `1`, `jacobiSC` returns exact symbolic output.

```
jacobiSC(sym(2),sym(1))
```

```
ans =
sinh(2)
```

Show that for other values of `u` or `m`, `jacobiSC` returns an unevaluated function call.

```
jacobiSC(sym(2),sym(3))
```

```
ans =
jacobiSC(2, 3)
```

Find Jacobi SC Elliptic Function for Symbolic Variables or Expressions

For symbolic variables or expressions, `jacobiSC` returns the unevaluated function call.

```
syms x y
f = jacobiSC(x,y)
```

```
f =
jacobiSC(x, y)
```

Substitute values for the variables by using `subs`, and convert values to double by using `double`.

```
f = subs(f, [x y], [3 5])
```

```
f =
jacobiSC(3, 5)
```

```
fVal = double(f)
```

```
fVal =
    0.0312
```

Calculate `f` to higher precision using `vpa`.

```
fVal = vpa(f)
```

```
fVal =
0.031159894327171581127518352857409
```

Plot Jacobi SC Elliptic Function

Plot the Jacobi SC elliptic function using `fcontour`. Set `u` on the x-axis and `m` on the y-axis by using the symbolic function `f` with the variable order `(u,m)`. Fill plot contours by setting `Fill` to `on`.

```
syms f(u,m)
f(u,m) = jacobiSC(u,m);
fcontour(f,'Fill','on')
title('Jacobi SC Elliptic Function')
xlabel('u')
ylabel('m')
```

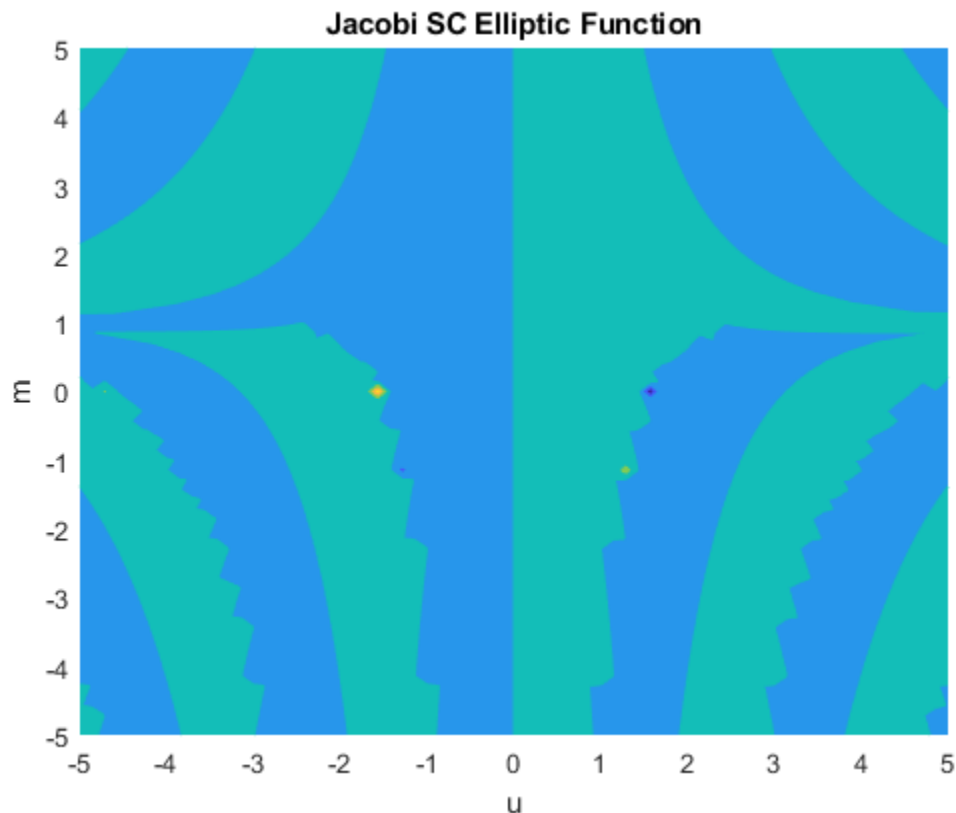

Input Arguments

u – Input

number | vector | matrix | multidimensional array | symbolic number | symbolic variable | symbolic vector | symbolic matrix | symbolic multidimensional array | symbolic function | symbolic expression

Input, specified as a number, vector, matrix, or multidimensional array, or a symbolic number, variable, vector, matrix, multidimensional array, function, or expression.

m – Input

number | vector | matrix | multidimensional array | symbolic number | symbolic variable | symbolic vector | symbolic matrix | symbolic multidimensional array | symbolic function | symbolic expression

Input, specified as a number, vector, matrix, or multidimensional array, or a symbolic number, variable, vector, matrix, multidimensional array, function, or expression.

More About

Jacobi SC Elliptic Function

The Jacobi SC elliptic function is

$$sc(u,m) = sn(u,m)/cn(u,m)$$

where sn and cn are the respective Jacobi elliptic functions.

The Jacobi elliptic functions are meromorphic and doubly periodic in their first argument with periods $4K(m)$ and $4iK'(m)$, where K is the complete elliptic integral of the first kind, implemented as `ellipticK`.

See Also

`ellipticK` | `jacobiAM` | `jacobiCD` | `jacobiCN` | `jacobiCS` | `jacobiDC` | `jacobiDN` | `jacobiDS` | `jacobiNC` | `jacobiND` | `jacobiNS` | `jacobiSD` | `jacobiSN` | `jacobiZeta`

Introduced in R2017b

jacobiSD

Jacobi SD elliptic function

Syntax

```
jacobiSD(u,m)
```

Description

`jacobiSD(u,m)` returns the “Jacobi SD Elliptic Function” on page 4-840 of `u` and `m`. If `u` or `m` is an array, then `jacobiSD` acts element-wise.

Examples

Calculate Jacobi SD Elliptic Function for Numeric Inputs

```
jacobiSD(2,1)
```

```
ans =  
    3.6269
```

Call `jacobiSD` on array inputs. `jacobiSD` acts element-wise when `u` or `m` is an array.

```
jacobiSD([2 1 -3],[1 2 3])
```

```
ans =  
    3.6269    2.1629 -126.3078
```

Calculate Jacobi SD Elliptic Function for Symbolic Numbers

Convert numeric input to symbolic form using `sym`, and find the Jacobi SD elliptic function. For symbolic input where `u = 0` or `m = 0` or `1`, `jacobiSD` returns exact symbolic output.

```
jacobiSD(sym(2),sym(1))
```

```
ans =  
sinh(2)
```

Show that for other values of `u` or `m`, `jacobiSD` returns an unevaluated function call.

```
jacobiSD(sym(2),sym(3))
```

```
ans =  
jacobiSD(2, 3)
```

Find Jacobi SD Elliptic Function for Symbolic Variables or Expressions

For symbolic variables or expressions, `jacobiSD` returns the unevaluated function call.

```
syms x y  
f = jacobiSD(x,y)
```

```
f =  
jacobiSD(x, y)
```

Substitute values for the variables by using `subs`, and convert values to double by using `double`.

```
f = subs(f, [x y], [3 5])
```

```
f =
jacobiSD(3, 5)
```

```
fVal = double(f)
```

```
fVal =
    0.0312
```

Calculate `f` to higher precision using `vpa`.

```
fVal = vpa(f)
```

```
fVal =
0.0312220579864538785956650143970485
```

Plot Jacobi SD Elliptic Function

Plot the Jacobi SD elliptic function using `fcontour`. Set `u` on the x-axis and `m` on the y-axis by using the symbolic function `f` with the variable order `(u,m)`. Fill plot contours by setting `Fill` to `on`.

```
syms f(u,m)
f(u,m) = jacobiSD(u,m);
fcontour(f, 'Fill', 'on')
title('Jacobi SD Elliptic Function')
xlabel('u')
ylabel('m')
```

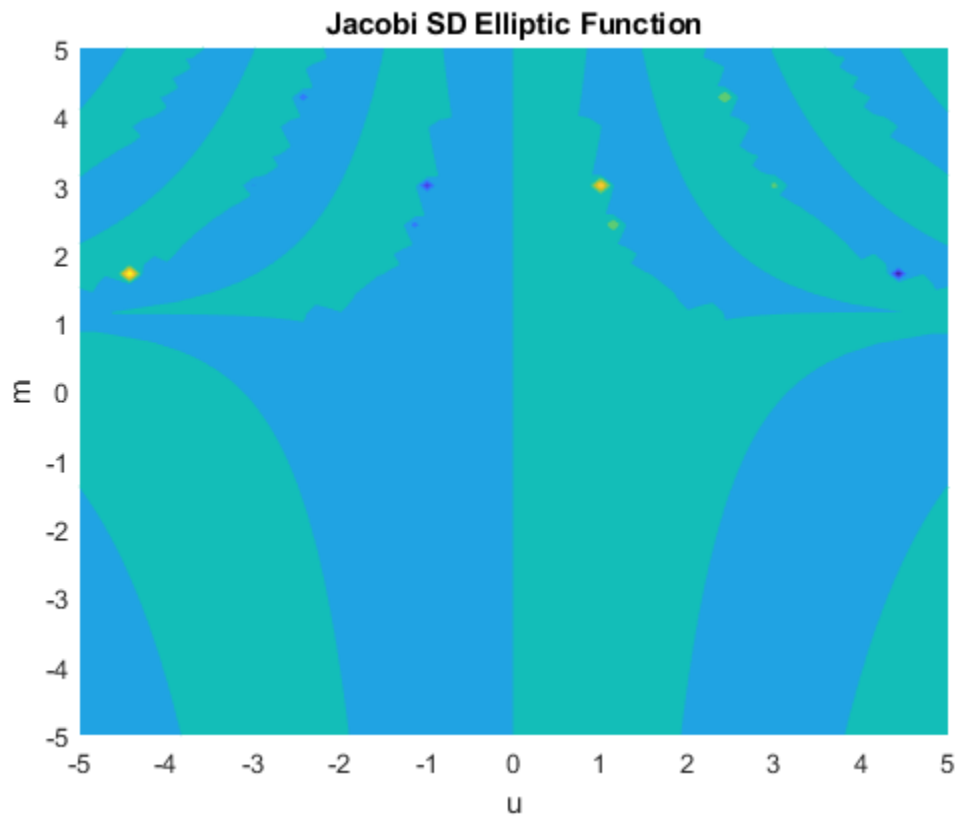

Input Arguments

u — Input

number | vector | matrix | multidimensional array | symbolic number | symbolic variable | symbolic vector | symbolic matrix | symbolic multidimensional array | symbolic function | symbolic expression

Input, specified as a number, vector, matrix, or multidimensional array, or a symbolic number, variable, vector, matrix, multidimensional array, function, or expression.

m — Input

number | vector | matrix | multidimensional array | symbolic number | symbolic variable | symbolic vector | symbolic matrix | symbolic multidimensional array | symbolic function | symbolic expression

Input, specified as a number, vector, matrix, or multidimensional array, or a symbolic number, variable, vector, matrix, multidimensional array, function, or expression.

More About

Jacobi SD Elliptic Function

The Jacobi SD elliptic function is

$$sd(u,m) = sn(u,m)/dn(u,m)$$

where sn and dn are the respective Jacobi elliptic functions.

The Jacobi elliptic functions are meromorphic and doubly periodic in their first argument with periods $4K(m)$ and $4iK'(m)$, where K is the complete elliptic integral of the first kind, implemented as `elliptick`.

See Also

`elliptick` | `jacobiAM` | `jacobiCD` | `jacobiCN` | `jacobiCS` | `jacobiDC` | `jacobiDN` | `jacobiDS` | `jacobiNC` | `jacobiND` | `jacobiNS` | `jacobiSC` | `jacobiSN` | `jacobiZeta`

Introduced in R2017b

jacobiSN

Jacobi SN elliptic function

Syntax

```
jacobiSN(u,m)
```

Description

`jacobiSN(u,m)` returns the “Jacobi SN Elliptic Function” on page 4-843 of `u` and `m`. If `u` or `m` is an array, then `jacobiSN` acts element-wise.

Examples

Calculate Jacobi SN Elliptic Function for Numeric Inputs

```
jacobiSN(2,1)
```

```
ans =
    0.9640
```

Call `jacobiSN` on array inputs. `jacobiSN` acts element-wise when `u` or `m` is an array.

```
jacobiSN([2 1 -3],[1 2 3])
```

```
ans =
    0.9640    0.6721    0.5773
```

Calculate Jacobi SN Elliptic Function for Symbolic Numbers

Convert numeric input to symbolic form using `sym`, and find the Jacobi SN elliptic function. For symbolic input where `u = 0` or `m = 0` or `1`, `jacobiSN` returns exact symbolic output.

```
jacobiSN(sym(2),sym(1))
```

```
ans =
tanh(2)
```

Show that for other values of `u` or `m`, `jacobiSN` returns an unevaluated function call.

```
jacobiSN(sym(2),sym(3))
```

```
ans =
jacobiSN(2, 3)
```

Find Jacobi SN Elliptic Function for Symbolic Variables or Expressions

For symbolic variables or expressions, `jacobiSN` returns the unevaluated function call.

```
syms x y
f = jacobiSN(x,y)
```

```
f =
jacobiSN(x, y)
```

Substitute values for the variables by using `subs`, and convert values to double by using `double`.

```
f = subs(f, [x y], [3 5])
```

```
f =
jacobiSN(3, 5)
```

```
fVal = double(f)
```

```
fVal =
    0.0311
```

Calculate `f` to higher precision using `vpa`.

```
fVal = vpa(f)
```

```
fVal =
0.0311444778155397389598324170696454
```

Plot Jacobi SN Elliptic Function

Plot the Jacobi SN elliptic function using `fcontour`. Set `u` on the x-axis and `m` on the y-axis by using the symbolic function `f` with the variable order `(u,m)`. Fill plot contours by setting `Fill` to `on`.

```
syms f(u,m)
f(u,m) = jacobiSN(u,m);
fcontour(f,'Fill','on')
title('Jacobi SN Elliptic Function')
xlabel('u')
ylabel('m')
```

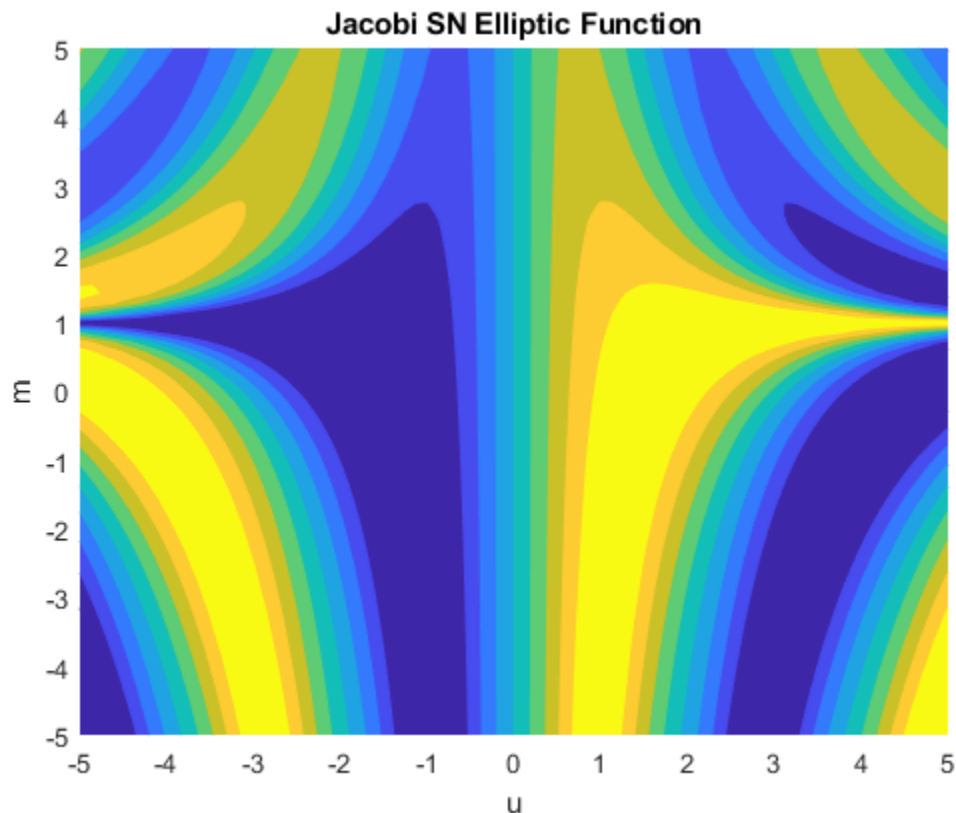

Input Arguments

u – Input

number | vector | matrix | multidimensional array | symbolic number | symbolic variable | symbolic vector | symbolic matrix | symbolic multidimensional array | symbolic function | symbolic expression

Input, specified as a number, vector, matrix, or multidimensional array, or a symbolic number, variable, vector, matrix, multidimensional array, function, or expression.

m – Input

number | vector | matrix | multidimensional array | symbolic number | symbolic variable | symbolic vector | symbolic matrix | symbolic multidimensional array | symbolic function | symbolic expression

Input, specified as a number, vector, matrix, or multidimensional array, or a symbolic number, variable, vector, matrix, multidimensional array, function, or expression.

More About

Jacobi SN Elliptic Function

The Jacobi SN elliptic function is $\text{sn}(u,m) = \sin(\text{am}(u,m))$ where am is the Jacobi amplitude function.

The Jacobi elliptic functions are meromorphic and doubly periodic in their first argument with periods $4K(m)$ and $4iK'(m)$, where K is the complete elliptic integral of the first kind, implemented as `ellipticK`.

See Also

`ellipticK` | `jacobiAM` | `jacobiCD` | `jacobiCN` | `jacobiCS` | `jacobiDC` | `jacobiDN` | `jacobiDS` | `jacobiNC` | `jacobiND` | `jacobiNS` | `jacobiSC` | `jacobiSD` | `jacobiZeta`

Introduced in R2017b

jacobiSymbol

Jacobi symbol

Syntax

`J = jacobiSymbol(a,n)`

Description

`J = jacobiSymbol(a,n)` returns the value of the Jacobi symbol on page 4-847 for integer a and positive odd integer n .

Examples

Periodicity of Jacobi Symbol

Find the Jacobi symbol for $a = 1, 2, \dots, 9$ and $n = 3$.

`a = 1:9;`

`n = 3;`

`J = jacobiSymbol(a,n)`

`J = 1×9`

1 -1 0 1 -1 0 1 -1 0

The Jacobi symbol is periodic with respect to its first argument, where $\left(\frac{a}{n}\right) = \left(\frac{b}{n}\right)$ if $a \equiv b \pmod{n}$.

Completely Multiplicative Property of Jacobi Symbol

Find the Jacobi symbol for $a = 28$ and $n = 9$.

`J = jacobiSymbol(28,9)`

`J = 1`

The Jacobi symbol is a completely multiplicative function, where the Jacobi symbol satisfies the relation $\left(\frac{a}{n}\right) = \left(\frac{a_1}{n}\right) \times \left(\frac{a_2}{n}\right) \times \dots \times \left(\frac{a_r}{n}\right)$ for $a = a_1 \times a_2 \times \dots \times a_r$. Show that the Jacobi symbol follows this relation for $a = 28 = 2 \times 2 \times 7$.

`Ja = jacobiSymbol(2,9)*jacobiSymbol(2,9)*jacobiSymbol(7,9)`

`Ja = 1`

The Jacobi symbol also satisfies the relation $\left(\frac{a}{n}\right) = \left(\frac{a}{n_1}\right) \times \left(\frac{a}{n_2}\right) \times \dots \times \left(\frac{a}{n_r}\right)$ for $n = n_1 \times n_2 \times \dots \times n_r$. Show that the Jacobi symbol follows this relation for $n = 9 = 3 \times 3$.

```
Jb = jacobiSymbol(28,3)*jacobiSymbol(28,3)
```

```
Jb = 1
```

Primality Test Using Jacobi Symbol

You can use the Jacobi symbol $\left(\frac{a}{n}\right)$ for the Solovay-Strassen primality test. If an odd integer $n > 1$ is prime, then the congruence

$$\left(\frac{a}{n}\right) \equiv a^{(n-1)/2} \pmod{n}$$

must hold for all integers a . If there is an integer a in $\{1, 2, \dots, n-1\}$ such that the congruence relation is not satisfied, then n is not prime.

Check if $n = 561$ is prime or not. Choose $a = 19$ and perform the primality test. Compare the two values in the congruence relation.

First calculate the left side of the congruence relation using the Jacobi symbol.

```
n = 561;
a = 19;
J = jacobiSymbol(a,n)
J = 1
```

Calculate the right side of the congruence relation.

```
m = powermod(a, (n-1)/2, n)
m = 67
```

The integer $n = 561$ is not prime since it does not satisfy the congruence relation for $a = 19$.

```
checkPrime = mod(J,n) == m
checkPrime = logical
0
```

Next, check if $n = 557$ is prime or not. Choose $a = 19$ and perform the primality test.

```
n = 557;
a = 19;
J = jacobiSymbol(a,n);
m = powermod(a, (n-1)/2, n);
```

The integer $n = 557$ is probably prime since it satisfies the congruence relation for $a = 19$.

```
checkPrime = mod(J,n) == m
```

```
checkPrime = logical  
1
```

Perform the primality test for all a in $\{1, 2, \dots, 556\}$ to confirm that the integer $n = 557$ is indeed prime.

```
a = 1:n-1;  
J = jacobiSymbol(a,n);  
m = powermod(a,(n-1)/2,n);  
checkPrime = all(mod(J,n) == m)
```

```
checkPrime = logical  
1
```

Verify the result with `isprime`.

```
isprime(n)  
  
ans = logical  
1
```

Input Arguments

a — Input

number | vector | matrix | array | symbolic number | symbolic array

Input, specified as a number, vector, matrix, array, symbolic number, or symbolic array. The elements of **a** must be integers. **a** and **n** must be the same size, or else one of them must be a scalar.

Data Types: single | double | sym

n — Input

number | vector | matrix | array | symbolic number | symbolic array

Input, specified as a number, vector, matrix, array, symbolic number, or symbolic array. The elements of **n** must be positive odd integers. **a** and **n** must be the same size, or else one of them must be a scalar.

Data Types: single | double | sym

Output Arguments

J — Output value

-1 | 0 | 1

Output value, returned as -1, 0, or 1.

Data Types: single | double | sym

More About

Jacobi Symbol

The Jacobi symbol $\left(\frac{a}{n}\right)$ is defined as the product of the Legendre symbols

$$\left(\frac{a}{n}\right) = \left(\frac{a}{p_1}\right)^{k_1} \left(\frac{a}{p_2}\right)^{k_2} \cdots \left(\frac{a}{p_r}\right)^{k_r}$$

for an integer a and a positive odd integer n with prime factorization

$$n = p_1^{k_1} p_2^{k_2} \cdots p_r^{k_r}.$$

The Legendre symbol $\left(\frac{a}{p}\right)$ for an integer a and an odd prime p is defined as

$$\left(\frac{a}{p}\right) = \begin{cases} 0 & \text{if } a \equiv 0 \pmod{p} \\ 1 & \text{if } a \text{ is a quadratic residue modulo } p \text{ or } x^2 \equiv a \pmod{p} \text{ has a nonzero solution for } x \\ -1 & \text{if } a \text{ is a quadratic nonresidue modulo } p \text{ or } x^2 \equiv a \pmod{p} \text{ has no solutions for } x. \end{cases}$$

When n is an odd prime, the Jacobi symbol is equal to the Legendre symbol.

References

- [1] Dietzfelbinger, M. *Primality Testing in Polynomial Time: From Randomized Algorithms to "PRIMES Is in P"*. Springer, 2004.

See Also

isprime | mod | powermod

Introduced in R2020a

jacobiZeta

Jacobi zeta function

Syntax

```
jacobiZeta(u,m)
```

Description

`jacobiZeta(u,m)` returns the “Jacobi Zeta Function” on page 4-850 of `u` and `m`. If `u` or `m` is an array, then `jacobiZeta` acts element-wise.

Examples

Calculate Jacobi Zeta Function for Numeric Inputs

```
jacobiZeta(2,1)
```

```
ans =  
    0.9640
```

Call `jacobiZeta` on array inputs. `jacobiZeta` acts element-wise when `u` or `m` is an array.

```
jacobiZeta([2 1 -3],[1 2 3])
```

```
ans =  
    0.9640 + 0.0000i    0.5890 - 0.4569i   -2.3239 + 1.9847i
```

Calculate Jacobi Zeta Function for Symbolic Numbers

Convert numeric input to symbolic form using `sym`, and find the Jacobi zeta function. For symbolic input where `u = 0` or `m = 0` or `1`, `jacobiZeta` returns exact symbolic output.

```
jacobiZeta(sym(2),sym(1))
```

```
ans =  
tanh(2)
```

Show that for other values of `u` or `m`, `jacobiZeta` returns an unevaluated function call.

```
jacobiZeta(sym(2),sym(3))
```

```
ans =  
jacobiZeta(2, 3)
```

Find Jacobi Zeta Function for Symbolic Variables or Expressions

For symbolic variables or expressions, `jacobiZeta` returns the unevaluated function call.

```
syms x y
f = jacobiZeta(x,y)
```

```
f =
jacobiZeta(x, y)
```

Substitute values for the variables by using `subs`, and convert values to double by using `double`.

```
f = subs(f, [x y], [3 5])
```

```
f =
jacobiZeta(3, 5)
```

```
fVal = double(f)
```

```
fVal =
    4.0986 - 3.0018i
```

Calculate `f` to arbitrary precision using `vpa`.

```
fVal = vpa(f)
```

```
fVal =
4.0986033838332279126523721581432 - 3.0017792319714320747021938869936i
```

Plot Jacobi Zeta Function

Plot real and imaginary values of the Jacobi zeta function using `fcontour`. Set `u` on the x-axis and `m` on the y-axis by using the symbolic function `f` with the variable order `(u,m)`. Fill plot contours by setting `Fill` to `on`.

```
syms f(u,m)
f(u,m) = jacobiZeta(u,m);
```

```
subplot(2,2,1)
fcontour(real(f), 'Fill', 'on')
title('Real Values of Jacobi Zeta')
xlabel('u')
ylabel('m')
```

```
subplot(2,2,2)
fcontour(imag(f), 'Fill', 'on')
title('Imaginary Values of Jacobi Zeta')
xlabel('u')
ylabel('m')
```

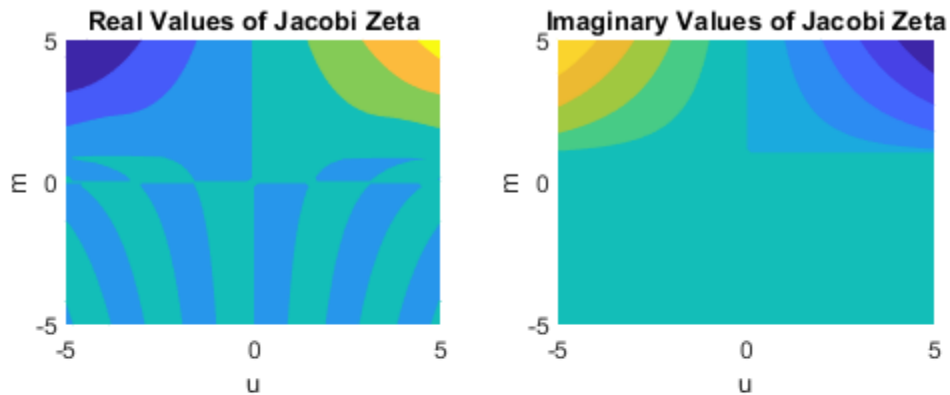

Input Arguments

u – Input

number | vector | matrix | multidimensional array | symbolic number | symbolic variable | symbolic vector | symbolic matrix | symbolic multidimensional array | symbolic function | symbolic expression

Input, specified as a number, vector, matrix, or multidimensional array, or a symbolic number, variable, vector, matrix, multidimensional array, function, or expression.

m – Input

number | vector | matrix | multidimensional array | symbolic number | symbolic variable | symbolic vector | symbolic matrix | symbolic multidimensional array | symbolic function | symbolic expression

Input, specified as a number, vector, matrix, or multidimensional array, or a symbolic number, variable, vector, matrix, multidimensional array, function, or expression.

More About

Jacobi Zeta Function

The Jacobi zeta function $Z(u, m)$ is defined as

$$Z(u, m) = \frac{2\pi}{K(m)} \left(\sum_{i=1}^{\infty} \frac{q(m)^i}{1 - q(m)^{2i}} \sin\left(\frac{2\pi}{K(m)} iu\right) \right).$$

$K(m)$ is the complete elliptic integral of the first kind, implemented as `ellipticK`. $q(m)$ is the elliptic nome, implemented as `ellipticNome`.

See Also

`jacobiAM` | `jacobiCD` | `jacobiCN` | `jacobiCS` | `jacobiDC` | `jacobiDN` | `jacobiDS` | `jacobiNC` |
`jacobiND` | `jacobiNS` | `jacobiSC` | `jacobiSD` | `jacobiSN`

Introduced in R2017b

jordan

Jordan normal form (Jordan canonical form)

Syntax

```
J = jordan(A)
[V,J] = jordan(A)
```

Description

`J = jordan(A)` computes the Jordan normal form of the matrix A . Because the Jordan form of a numeric matrix is sensitive to numerical errors, prefer converting numeric input to exact symbolic form.

`[V,J] = jordan(A)` computes the Jordan form J and the similarity transform V . The matrix V contains the generalized eigenvectors of A as columns, such that $V \backslash A * V = J$.

Examples

Compute Jordan Form and Similarity Transform

Compute the Jordan form and the similarity transform for a matrix. Because the Jordan form of a numeric matrix is sensitive to numerical errors, first convert the matrix to symbolic form by using `sym`.

```
A = [ 1 -3 -2;
      -1 1 -1;
       2 4 5];
A = sym(A);
[V,J] = jordan(A)
```

```
V =
[ -1, 1, -1]
[ -1, 0,  0]
[  2, 0,  1]
```

```
J =
[ 2, 1, 0]
[ 0, 2, 0]
[ 0, 0, 3]
```

Verify that V satisfies the condition $V \backslash A * V = J$ by using `isAlways`.

```
cond = J == V \ A * V;
isAlways(cond)

ans =
  3×3 logical array
   1   1   1
```

$$\begin{matrix} 1 & 1 & 1 \\ 1 & 1 & 1 \end{matrix}$$
See Also

`charpoly` | `eig` | `hermiteForm` | `inv` | `smithForm`

Introduced before R2006a

kronckerDelta

Kronecker delta function

Syntax

```
kronckerDelta(m)
kronckerDelta(m,n)
```

Description

`kronckerDelta(m)` returns 1 if $m == 0$ and 0 if $m \neq 0$.

`kronckerDelta(m,n)` returns 1 if $m == n$ and 0 if $m \neq n$.

Examples

Compare Two Symbolic Variables

Note For `kronckerDelta` with numeric inputs, use the `eq` function instead.

Set symbolic variable `m` equal to symbolic variable `n` and test their equality using `kronckerDelta`.

```
syms m n
m = n;
kronckerDelta(m,n)
```

```
ans =
1
```

`kronckerDelta` returns 1 indicating that the inputs are equal.

Compare symbolic variables `p` and `q`.

```
syms p q
kronckerDelta(p,q)
```

```
ans =
kronckerDelta(p - q, 0)
```

`kronckerDelta` cannot decide if $p == q$ and returns the function call with the undecidable input. Note that `kronckerDelta(p, q)` is equal to `kronckerDelta(p - q, 0)`.

To force a logical result for undecidable inputs, use `isAlways`. The `isAlways` function issues a warning and returns logical 0 (false) for undecidable inputs. Set the `Unknown` option to `false` to suppress the warning.

```
isAlways(kronckerDelta(p, q), 'Unknown', 'false')
```

```
ans =
logical
0
```

Compare Symbolic Variable with Zero

Set symbolic variable m to 0 and test m for equality with 0 . The `kroneckerDelta` function errors because it does not accept numeric inputs of type `double`.

```
m = 0;
kroneckerDelta(m)
```

Undefined function 'kroneckerDelta' for input arguments of type 'double'.

Use `sym` to convert 0 to a symbolic object before assigning it to m . This is because `kroneckerDelta` only accepts symbolic inputs.

```
syms m
m = sym(0);
kroneckerDelta(m)
```

```
ans =
     1
```

`kroneckerDelta` returns `1` indicating that m is equal to 0 . Note that `kroneckerDelta(m)` is equal to `kroneckerDelta(m, 0)`.

Compare Vector of Numbers with Symbolic Variable

Compare a vector of numbers `[1 2 3 4]` with symbolic variable m . Set m to `3`.

```
V = 1:4
syms m
m = sym(3)
sol = kroneckerDelta(V,m)
```

```
V =
     1     2     3     4
m =
     3
sol =
 [ 0, 0, 1, 0]
```

`kroneckerDelta` acts on V element-wise to return a vector, `sol`, which is the same size as V . The third element of `sol` is `1` indicating that the third element of V equals m .

Compare Two Matrices

Compare matrices A and B .

Declare matrices A and B .

```
syms m
A = [m m+1 m+2;m-2 m-1 m]
B = [m m+3 m+2;m-1 m-1 m+1]
```

```
A =
 [ m, m + 1, m + 2]
 [ m - 2, m - 1, m]
B =
 [ m, m + 3, m + 2]
 [ m - 1, m - 1, m + 1]
```

Compare A and B using `kronckerDelta`.

```
sol = kronckerDelta(A,B)
```

```
sol =  
[ 1, 0, 1]  
[ 0, 1, 0]
```

`kronckerDelta` acts on A and B element-wise to return the matrix `sol` which is the same size as A and B. The elements of `sol` that are 1 indicate that the corresponding elements of A and B are equal. The elements of `sol` that are 0 indicate that the corresponding elements of A and B are not equal.

Use `kronckerDelta` in Inputs to Other Functions

`kronckerDelta` appears in the output of `iztrans`.

```
syms z n  
sol = iztrans(1/(z-1), z, n)
```

```
sol =  
1 - kronckerDelta(n, 0)
```

Use this output as input to `ztrans` to return the initial input expression.

```
ztrans(sol, n, z)
```

```
ans =  
z/(z - 1) - 1
```

Filter Response to Kronecker Delta Input

Use `filter` to find the response of a filter when the input is the Kronecker Delta function. Convert `k` to a symbolic vector using `sym` because `kronckerDelta` only accepts symbolic inputs, and convert it back to double using `double`. Provide arbitrary filter coefficients `a` and `b` for simplicity.

```
b = [0 1 1];  
a = [1 -0.5 0.3];  
k = -20:20;  
x = double(kronckerDelta(sym(k)));  
y = filter(b,a,x);  
plot(k,y)
```

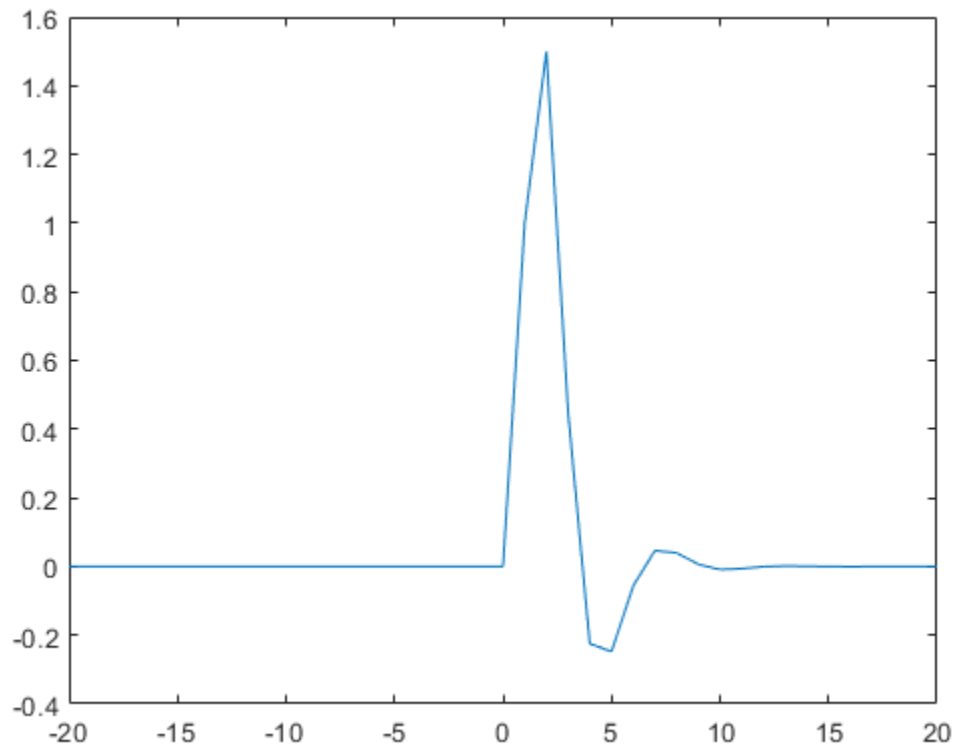

Input Arguments

m – Input

number | vector | matrix | multidimensional array | symbolic number | symbolic vector | symbolic matrix | symbolic function | symbolic multidimensional array

Input, specified as a number, vector, matrix, multidimensional array, or a symbolic number, vector, matrix, function, or multidimensional array. At least one of the inputs, *m* or *n*, must be symbolic.

n – Input

number | vector | matrix | multidimensional array | symbolic number | symbolic vector | symbolic matrix | symbolic function | symbolic multidimensional array

Input, specified as a number, vector, matrix, multidimensional array, or a symbolic number, vector, matrix, function, or multidimensional array. At least one of the inputs, *m* or *n*, must be symbolic.

More About

Kronecker Delta Function

The Kronecker delta function is defined as

$$\delta(m, n) = \begin{cases} 0 & \text{if } m \neq n \\ 1 & \text{if } m = n \end{cases}$$

Tips

- When m or n is NaN, the `kronDelta` function returns NaN.

See Also

`iztrans` | `ztrans`

Introduced in R2014b

kummerU

Confluent hypergeometric Kummer U function

Syntax

`kummerU(a, b, z)`

Description

`kummerU(a, b, z)` computes the value of confluent hypergeometric function, $U(a, b, z)$. If the real parts of z and a are positive values, then the integral representations of the Kummer U function is as follows:

$$U(a, b, z) = \frac{1}{\Gamma(a)} \int_0^{\infty} e^{-zt} t^{a-1} (1+t)^{b-a-1} dt$$

Examples

Equation Returning the Kummer U Function as Its Solution

`dsolve` can return solutions of second-order ordinary differential equations in terms of the Kummer U function.

Solve this equation. The solver returns the results in terms of the Kummer U function and another hypergeometric function.

```
syms t z y(z)
dsolve(z^3*diff(y,2) + (z^2 + t)*diff(y) + z*y)

ans =
(C4*hypergeom(1i/2, 1 + 1i, t/(2*z^2)))/z^1i + ...
(C3*kummerU(1i/2, 1 + 1i, t/(2*z^2)))/z^1i
```

Kummer U Function for Numeric and Symbolic Arguments

Depending on its arguments, `kummerU` can return floating-point or exact symbolic results.

Compute the Kummer U function for these numbers. Because these numbers are not symbolic objects, you get floating-point results.

```
A = [kummerU(-1/3, 2.5, 2)
kummerU(1/3, 2, pi)
kummerU(1/2, 1/3, 3*i)]

A =
0.8234 + 0.0000i
0.7284 + 0.0000i
0.4434 - 0.3204i
```

Compute the Kummer U function for the numbers converted to symbolic objects. For most symbolic (exact) numbers, `kummerU` returns unresolved symbolic calls.

```

symA = [kummerU(-1/3, 2.5, sym(2))
kummerU(1/3, 2, sym(pi))
kummerU(1/2, sym(1/3), 3*i)]

symA =
    kummerU(-1/3, 5/2, 2)
    kummerU(1/3, 2, pi)
    kummerU(1/2, 1/3, 3i)

```

Use `vpa` to approximate symbolic results with the required number of digits.

```

vpa(symA,10)

ans =
    0.8233667846
    0.7284037305
    0.4434362538 - 0.3204327531i

```

Some Special Values of Kummer U

The Kummer U function has special values for some parameters.

If a is a negative integer, the Kummer U function reduces to a polynomial.

```

syms a b z
[kummerU(-1, b, z)
kummerU(-2, b, z)
kummerU(-3, b, z)]

ans =
    6*z*(b^2/2 + (3*b)/2 + 1) - 2*b - 6*z^2*(b/2 + 1) - 3*b^2 - b^3 + z^3

```

If $b = 2*a$, the Kummer U function reduces to an expression involving the modified Bessel function of the second kind.

```

kummerU(a, 2*a, z)

ans =
(z^(1/2 - a)*exp(z/2)*besselk(a - 1/2, z/2))/pi^(1/2)

```

If $a = 1$ or $a = b$, the Kummer U function reduces to an expression involving the incomplete gamma function.

```

kummerU(1, b, z)

ans =
z^(1 - b)*exp(z)*igamma(b - 1, z)

kummerU(a, a, z)

ans =
exp(z)*igamma(1 - a, z)

```

If $a = 0$, the Kummer U function is 1.

```

kummerU(0, a, z)

```

```
ans =
1
```

Handle Expressions Containing the Kummer U Function

Many functions, such as `diff`, `int`, and `limit`, can handle expressions containing `kummerU`.

Find the first derivative of the Kummer U function with respect to z .

```
syms a b z
diff(kummerU(a, b, z), z)
```

```
ans =
(a*kummerU(a + 1, b, z)*(a - b + 1))/z - (a*kummerU(a, b, z))/z
```

Find the indefinite integral of the Kummer U function with respect to z .

```
int(kummerU(a, b, z), z)
```

```
ans =
((b - 2)/(a - 1) - 1)*kummerU(a, b, z) + ...
(kummerU(a + 1, b, z)*(a - a*b + a^2))/(a - 1) - ...
(z*kummerU(a, b, z))/(a - 1)
```

Find the limit of this Kummer U function.

```
limit(kummerU(1/2, -1, z), z, 0)
```

```
ans =
4/(3*pi^(1/2))
```

Input Arguments

a — Parameter of Kummer U function

number | vector | symbolic number | symbolic variable | symbolic expression | symbolic function | symbolic vector

Parameter of Kummer U function, specified as a number, variable, symbolic expression, symbolic function, or vector.

b — Parameter of Kummer U function

number | vector | symbolic number | symbolic variable | symbolic expression | symbolic function | symbolic vector

Parameter of Kummer U function, specified as a number, variable, symbolic expression, symbolic function, or vector.

z — Argument of Kummer U function

number | vector | symbolic number | symbolic variable | symbolic expression | symbolic function | symbolic vector

Argument of Kummer U function, specified as a number, variable, symbolic expression, symbolic function, or vector. If z is a vector, `kummerU(a, b, z)` is evaluated element-wise.

More About

Confluent Hypergeometric Function (Kummer U Function)

The confluent hypergeometric function (Kummer U function) is one of the solutions of the differential equation

$$z \frac{\partial^2}{\partial z^2} y + (b - z) \frac{\partial}{\partial z} y - ay = 0$$

The other solution is the hypergeometric function ${}_1F_1(a, b, z)$.

The Whittaker W function can be expressed in terms of the Kummer U function:

$$W_{a,b}(z) = e^{-z/2} z^{b+1/2} U\left(b - a + \frac{1}{2}, 2b + 1, z\right)$$

Tips

- `kummerU` returns floating-point results for numeric arguments that are not symbolic objects.
- `kummerU` acts element-wise on nonscalar inputs.
- All nonscalar arguments must have the same size. If one or two input arguments are nonscalar, then `kummerU` expands the scalars into vectors or matrices of the same size as the nonscalar arguments, with all elements equal to the corresponding scalar.

References

- [1] Slater, L. J. "Confluent Hypergeometric Functions." *Handbook of Mathematical Functions with Formulas, Graphs, and Mathematical Tables*. (M. Abramowitz and I. A. Stegun, eds.). New York: Dover, 1972.

See Also

`hypergeom` | `whittakerM` | `whittakerW`

Introduced in R2014b

laguerreL

Generalized Laguerre Function and Laguerre Polynomials

Syntax

```
laguerreL(n,x)
laguerreL(n,a,x)
```

Description

`laguerreL(n,x)` returns the Laguerre polynomial of degree n if n is a nonnegative integer. When n is not a nonnegative integer, `laguerreL` returns the Laguerre function. For details, see “Generalized Laguerre Function” on page 4-867.

`laguerreL(n,a,x)` returns the generalized Laguerre polynomial of degree n if n is a nonnegative integer. When n is not a nonnegative integer, `laguerreL` returns the generalized Laguerre function.

Examples

Find Laguerre Polynomials for Numeric and Symbolic Inputs

Find the Laguerre polynomial of degree 3 for input 4.3.

```
laguerreL(3,4.3)
```

```
ans =
    2.5838
```

Find the Laguerre polynomial for symbolic inputs. Specify degree n as 3 to return the explicit form of the polynomial.

```
syms x
laguerreL(3,x)
```

```
ans =
- x^3/6 + (3*x^2)/2 - 3*x + 1
```

If the degree of the Laguerre polynomial n is not specified, `laguerreL` cannot find the polynomial. When `laguerreL` cannot find the polynomial, it returns the function call.

```
syms n x
laguerreL(n,x)
```

```
ans =
laguerreL(n, x)
```

Find Generalized Laguerre Polynomial

Find the explicit form of the generalized Laguerre polynomial $L(n,a,x)$ of degree $n = 2$.

```
syms a x
laguerreL(2,a,x)
```

```
ans =
(3*a)/2 - x*(a + 2) + a^2/2 + x^2/2 + 1
```

Return Generalized Laguerre Function

When n is not a nonnegative integer, `laguerreL(n, a, x)` returns the generalized Laguerre function.

```
laguerreL(-2.7,3,2)
```

```
ans =
    0.2488
```

`laguerreL` is not defined for certain inputs and returns an error.

```
syms x
laguerreL(-5/2, -3/2, x)
```

```
Error using symengine
Function 'laguerreL' not supported for parameter values '-5/2' and '-3/2'.
```

Find Laguerre Polynomial with Vector and Matrix Inputs

Find the Laguerre polynomials of degrees 1 and 2 by setting $n = [1 \ 2]$.

```
syms x
laguerreL([1 2],x)
```

```
ans =
[ 1 - x, x^2/2 - 2*x + 1]
```

`laguerreL` acts element-wise on n to return a vector with two elements.

If multiple inputs are specified as a vector, matrix, or multidimensional array, the inputs must be the same size. Find the generalized Laguerre polynomials where input arguments n and x are matrices.

```
syms a
n = [2 3; 1 2];
xM = [x^2 11/7; -3.2 -x];
laguerreL(n,a,xM)

ans =
[ a^2/2 - a*x^2 + (3*a)/2 + x^4/2 - 2*x^2 + 1, ...
  a^3/6 + (3*a^2)/14 - (253*a)/294 - 676/1029]
[ a^2/2 + a*x + (3*a)/2 + x^2/2 + 2*x + 1, ...
  a + 21/5, ...]
```

`laguerreL` acts element-wise on n and x to return a matrix of the same size as n and x .

Differentiate and Find Limits of Laguerre Polynomials

Use `limit` to find the limit of a generalized Laguerre polynomial of degree 3 as x tends to ∞ .

```
syms x
expr = laguerreL(3,2,x);
limit(expr,x,Inf)
```

```
ans =
-Inf
```

Use `diff` to find the third derivative of the generalized Laguerre polynomial `laguerreL(n, a, x)`.

```
syms n a
expr = laguerreL(n,a,x);
diff(expr,x,3)

ans =
-laguerreL(n - 3, a + 3, x)
```

Find Taylor Series Expansion of Laguerre Polynomials

Use `taylor` to find the Taylor series expansion of the generalized Laguerre polynomial of degree 2 at $x = 0$.

```
syms a x
expr = laguerreL(2,a,x);
taylor(expr,x)

ans =
(3*a)/2 - x*(a + 2) + a^2/2 + x^2/2 + 1
```

Plot Laguerre Polynomials

Plot the Laguerre polynomials of orders 1 through 4.

```
syms x
fplot(laguerreL(1:4,x))
axis([-2 10 -10 10])
grid on

ylabel('L_n(x)')
title('Laguerre polynomials of orders 1 through 4')
legend('1','2','3','4','Location','best')
```

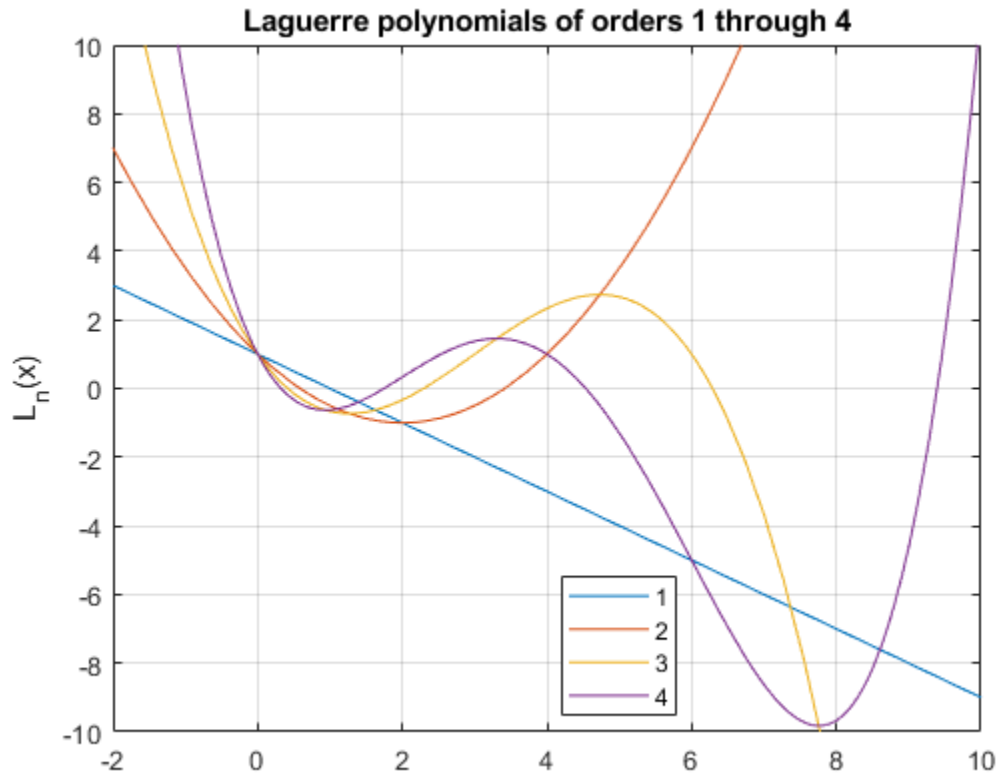

Input Arguments

n – Degree of polynomial

number | vector | matrix | multidimensional array | symbolic number | symbolic vector | symbolic matrix | symbolic function | symbolic multidimensional array

Degree of polynomial, specified as a number, vector, matrix, multidimensional array, or a symbolic number, vector, matrix, function, or multidimensional array.

x – Input

number | vector | matrix | multidimensional array | symbolic number | symbolic vector | symbolic matrix | symbolic function | symbolic multidimensional array

Input, specified as a number, vector, matrix, multidimensional array, or a symbolic number, vector, matrix, function, or multidimensional array.

a – Input

number | vector | matrix | multidimensional array | symbolic number | symbolic vector | symbolic matrix | symbolic function | symbolic multidimensional array

Input, specified as a number, vector, matrix, multidimensional array, or a symbolic number, vector, matrix, function, or multidimensional array.

More About

Generalized Laguerre Function

The generalized Laguerre function is defined in terms of the hypergeometric function as

$$\text{laguerreL}(n, a, x) = \binom{n+a}{a} {}_1F_1(-n; a+1; x).$$

For nonnegative integer values of n , the function returns the generalized Laguerre polynomials that are orthogonal with respect to the scalar product

$$\langle f_1, f_2 \rangle = \int_0^{\infty} e^{-x} x^a f_1(x) f_2(x) dx.$$

In particular, the generalized Laguerre polynomials satisfy this normalization.

$$\langle \text{laguerreL}(n, a, x), \text{laguerreL}(m, a, x) \rangle = \begin{cases} 0 & \text{if } n \neq m \\ \frac{\Gamma(a+n+1)}{n!} & \text{if } n = m. \end{cases}$$

Algorithms

- The generalized Laguerre function is not defined for all values of parameters n and a because certain restrictions on the parameters exist in the definition of the hypergeometric functions. If the generalized Laguerre function is not defined for a particular pair of n and a , the `laguerreL` function returns an error message. See “Return Generalized Laguerre Function” on page 4-864.
- The calls `laguerreL(n, x)` and `laguerreL(n, 0, x)` are equivalent.
- If n is a nonnegative integer, the `laguerreL` function returns the explicit form of the corresponding Laguerre polynomial.
- The special values $\text{laguerreL}(n, a, 0) = \binom{n+a}{a}$ are implemented for arbitrary values of n and a .
- If n is a negative integer and a is a numerical noninteger value satisfying $a \geq -n$, then `laguerreL` returns θ .
- If n is a negative integer and a is an integer satisfying $a < -n$, the function returns an explicit expression defined by the reflection rule

$$\text{laguerreL}(n, a, x) = (-1)^a e^x \text{laguerreL}(-n-a-1, a, -x)$$

- If all arguments are numerical and at least one argument is a floating-point number, then `laguerreL(x)` returns a floating-point number. For all other arguments, `laguerreL(n, a, x)` returns a symbolic function call.

See Also

`chebyshevT` | `chebyshevU` | `gegenbauerC` | `hermiteH` | `hypergeom` | `jacobiP` | `legendreP`

Introduced in R2014b

lambertw

Lambert W function

Syntax

```
lambertw(x)
lambertw(k,x)
```

Description

`lambertw(x)` returns the principal branch of the Lambert W function on page 4-875. This syntax is equivalent to `lambertw(0,x)`.

`lambertw(k,x)` is the *k*th branch of the Lambert W function. This syntax returns real values only if $k = 0$ or $k = -1$.

Examples

Return Equation with Lambert W Function as Its Solution

The Lambert W function $W(x)$ is a set of solutions of the equation $x = W(x)e^{W(x)}$.

Solve this equation. The solution is the Lambert W function.

```
syms x W
eqn = x == W*exp(W);
solve(eqn,W)
```

```
ans =
lambertw(0, x)
```

Verify that branches of the Lambert W function are valid solutions of the equation $x = W e^W$:

```
k = -2:2;
eqn = subs(eqn,W,lambertw(k,x));
isAlways(eqn)
```

```
ans =
1x5 logical array
    1     1     1     1     1
```

Lambert W Function for Numeric and Symbolic Arguments

Depending on its arguments, `lambertw` can return floating-point or exact symbolic results.

Compute the Lambert W functions for these numbers. Because the numbers are not symbolic objects, you get floating-point results.

```
A = [0 -1/exp(1); pi i];
lambertw(A)

ans =
    0.0000 + 0.0000i  -1.0000 + 0.0000i
    1.0737 + 0.0000i   0.3747 + 0.5764i

lambertw(-1,A)
```

```
ans =
   -Inf + 0.0000i  -1.0000 + 0.0000i
  -0.3910 - 4.6281i  -1.0896 - 2.7664i
```

Compute the Lambert W functions for the numbers converted to symbolic objects. For most symbolic (exact) numbers, `lambertw` returns unresolved symbolic calls.

```
A = [0 -1/exp(sym(1)); pi i];
W0 = lambertw(A)

W0 =
 [
      0,          -1]
 [ lambertw(0, pi), lambertw(0, 1i)]

Wmin1 = lambertw(-1,A)
```

```
Wmin1 =
 [
      -Inf,          -1]
 [ lambertw(-1, pi), lambertw(-1, 1i)]
```

Convert symbolic results to double by using `double`.

```
double(W0)

ans =
    0.0000 + 0.0000i  -1.0000 + 0.0000i
    1.0737 + 0.0000i   0.3747 + 0.5764i
```

Plot Two Main Branches of Lambert W Function

Plot the two main branches, $W_0(x)$ and $W_{-1}(x)$, of the Lambert W function.

```
syms x
fplot(lambertw(x))
hold on
fplot(lambertw(-1,x))
hold off
axis([-0.5 4 -4 2])
title('Lambert W function, two main branches')
legend('k=0', 'k=1', 'Location', 'best')
```

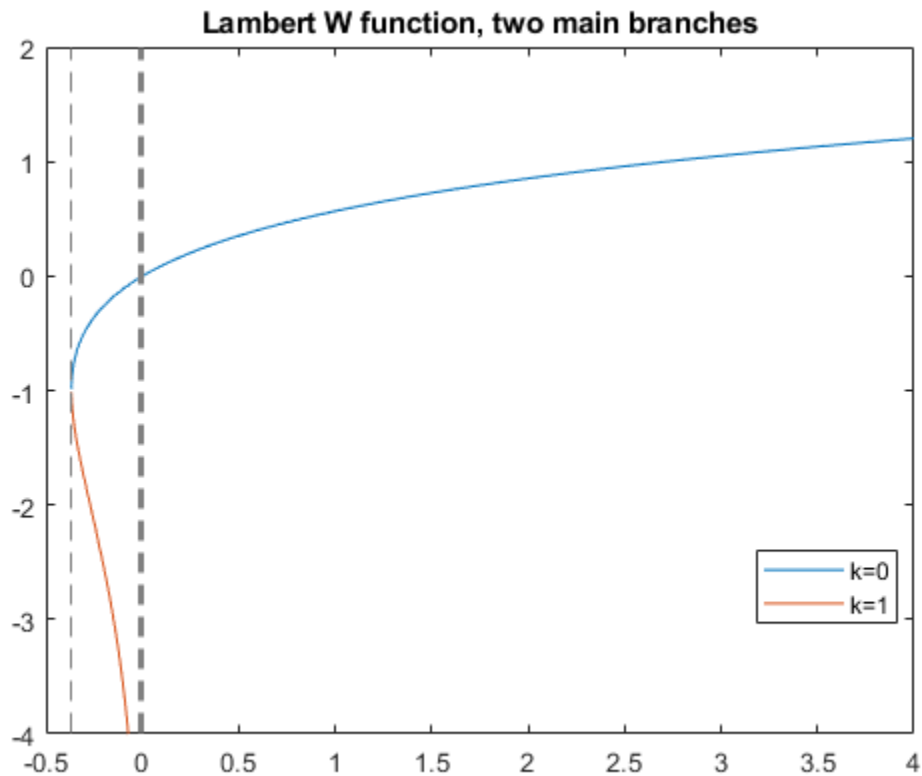

Lambert W Function Plot on Complex Plane

Plot the principal branch of the Lambert W function on the complex plane.

Plot the real value of the Lambert W function by using `fmesh`. Simultaneously plot the contours by setting `ShowContours` to `'On'`.

```
syms x y
f = lambertw(x + 1i*y);
interval = [-100 100 -100 100];
fmesh(real(f),interval,'ShowContours','On')
```

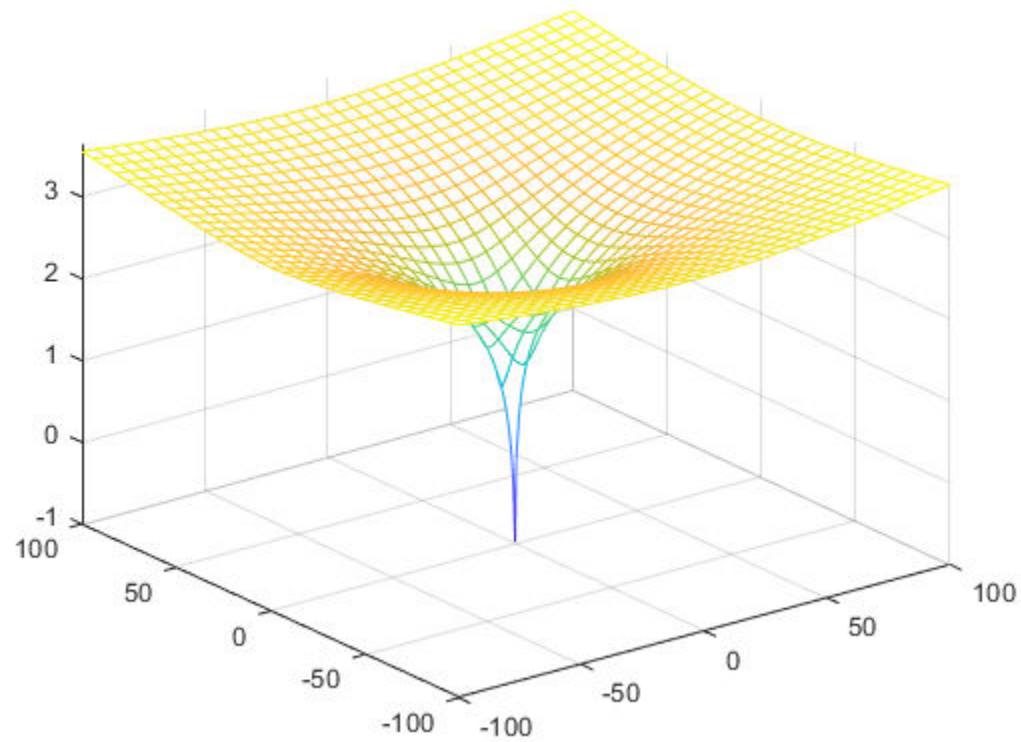

Plot the imaginary value of the Lambert W function. The plot has a branch cut along the negative real axis. Plot the contours separately.

```
fmesh(imag(f), interval)
```

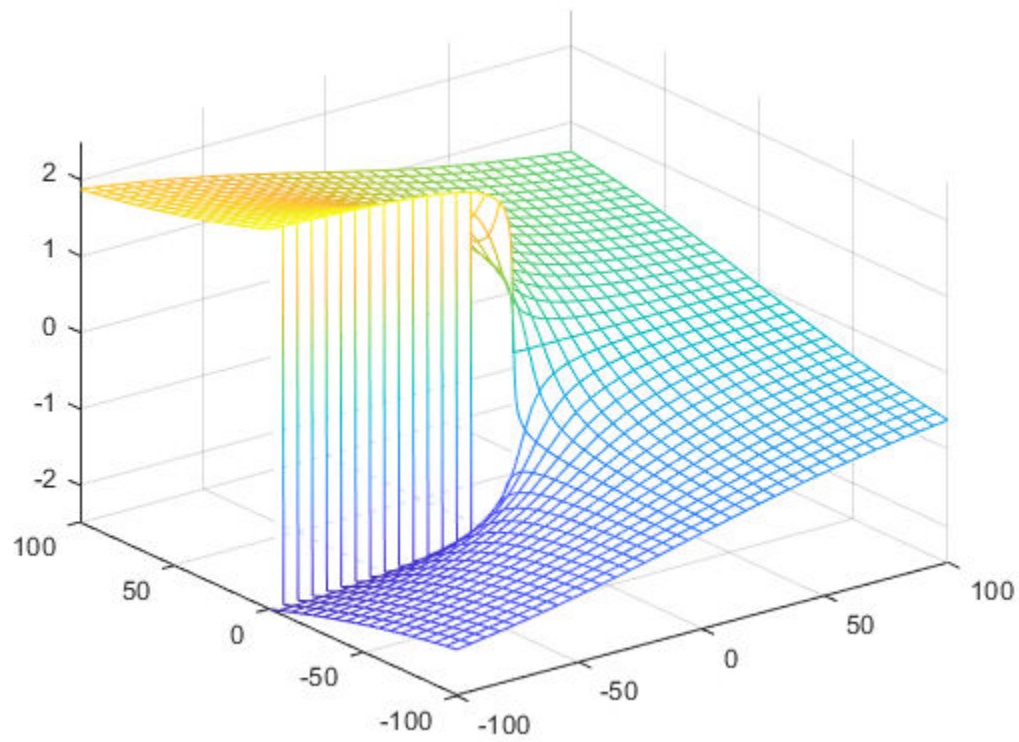

```
fcontour(imag(f),interval,'Fill','on')
```

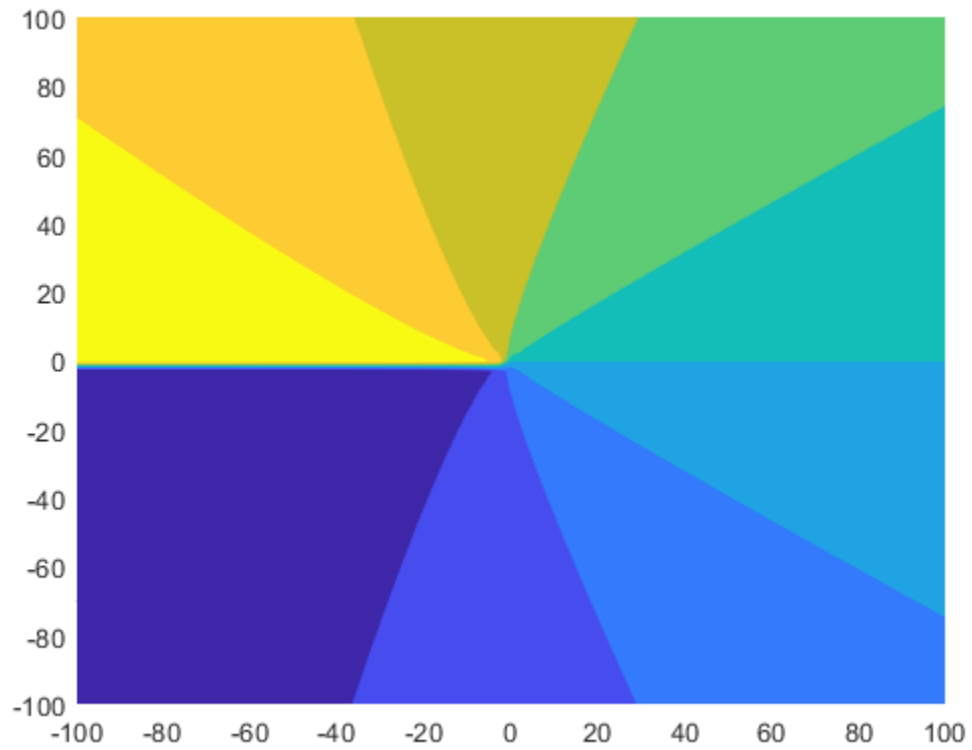

Plot the absolute value of the Lambert W function.

```
fmesh(abs(f), interval, 'ShowContours', 'On')
```

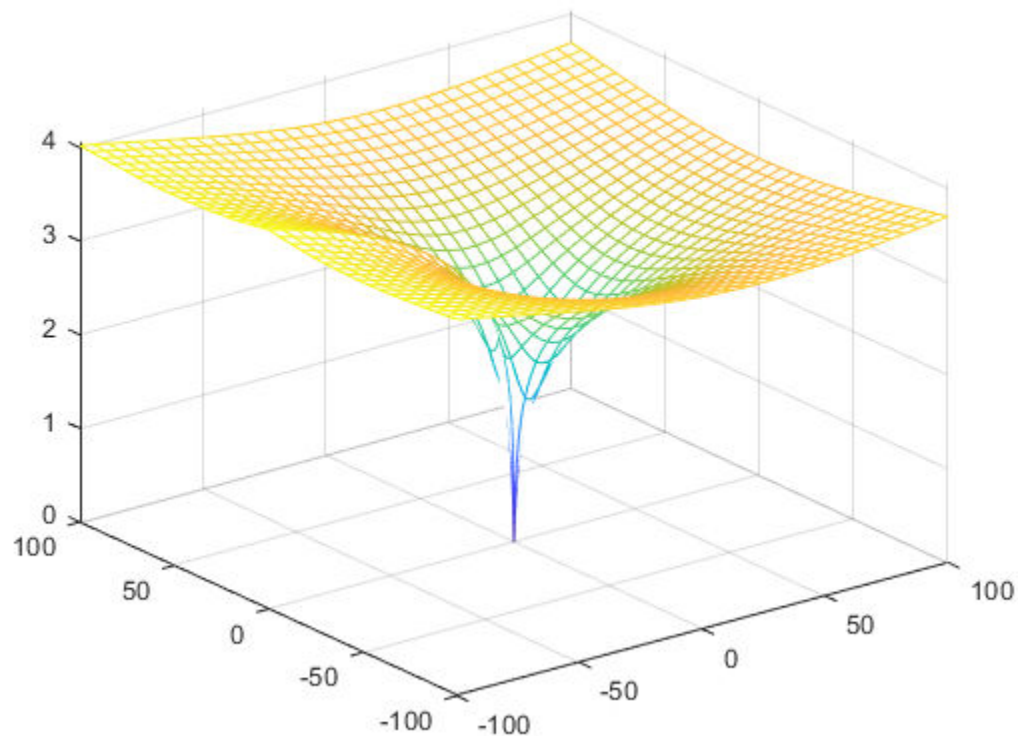

Input Arguments

x – Input

number | vector | matrix | array | symbolic number | symbolic variable | symbolic array | symbolic function | symbolic expression

Input, specified as a number, vector, matrix, or array, or a symbolic number, variable, array, function, or expression.

At least one input argument must be a scalar, or both arguments must be vectors or matrices of the same size. If one input argument is a scalar and the other is a vector or matrix, `lambertw` expands the scalar into a vector or matrix of the same size as the other argument with all elements equal to that scalar.

k – Branch of Lambert W function

integer | vector or matrix of integers | symbolic integer | symbolic vector or matrix of integers

Branch of Lambert W function, specified as an integer, a vector or matrix of integers, a symbolic integer, or a symbolic vector or matrix of integers.

At least one input argument must be a scalar, or both arguments must be vectors or matrices of the same size. If one input argument is a scalar and the other is a vector or matrix, `lambertw` expands the scalar into a vector or matrix of the same size as the other argument with all elements equal to that scalar.

More About

Lambert W Function

The Lambert W function $W(x)$ represents the solutions y of the equation $ye^y = x$ for any complex number x .

- For complex x , the equation has an infinite number of solutions $y = \text{lambertW}(k,x)$ where k ranges over all integers.
- For all real $x \geq 0$, the equation has exactly one real solution $y = \text{lambertW}(x) = \text{lambertW}(0,x)$.
- For real x where $-e^{-1} < x < 0$, the equation has exactly two real solutions. The larger solution is represented by $y = \text{lambertW}(x)$ and the smaller solution by $y = \text{lambertW}(-1,x)$.
- For $x = -e^{-1}$, the equation has exactly one real solution $y = -1 = \text{lambertW}(0, -\exp(-1)) = \text{lambertW}(-1, -\exp(-1))$.

References

- [1] Corless, R.M., G.H. Gonnet, D.E.G. Hare, D.J. Jeffrey, and D.E. Knuth. "On the Lambert W Function." *Advances in Computational Mathematics*, Vol. 5, pp. 329-359, 1996.

See Also

Functions

wrightOmega

Introduced before R2006a

laplace

Laplace transform

Syntax

```
laplace(f)
laplace(f,transVar)
laplace(f,var,transVar)
```

Description

`laplace(f)` returns the “Laplace Transform” on page 4-879 of `f`. By default, the independent variable is `t` and the transformation variable is `s`.

`laplace(f,transVar)` uses the transformation variable `transVar` instead of `s`.

`laplace(f,var,transVar)` uses the independent variable `var` and the transformation variable `transVar` instead of `t` and `s`, respectively.

Examples

Laplace Transform of Symbolic Expression

Compute the Laplace transform of $1/\sqrt{x}$. By default, the transform is in terms of `s`.

```
syms x y
f = 1/sqrt(x);
laplace(f)

ans =
pi^(1/2)/s^(1/2)
```

Specify Independent Variable and Transformation Variable

Compute the Laplace transform of $\exp(-a*t)$. By default, the independent variable is `t`, and the transformation variable is `s`.

```
syms a t
f = exp(-a*t);
laplace(f)

ans =
1/(a + s)
```

Specify the transformation variable as `y`. If you specify only one variable, that variable is the transformation variable. The independent variable is still `t`.

```
laplace(f,y)
```

```
ans =
1/(a + y)
```

Specify both the independent and transformation variables as a and y in the second and third arguments, respectively.

```
laplace(f,a,y)
```

```
ans =
1/(t + y)
```

Laplace Transforms of Dirac and Heaviside Functions

Compute the Laplace transforms of the Dirac and Heaviside functions.

```
syms t s
laplace(dirac(t-3),t,s)
```

```
ans =
exp(-3*s)
```

```
laplace(heaviside(t-pi),t,s)
```

```
ans =
exp(-pi*s)/s
```

Relation Between Laplace Transform of Function and Its Derivative

Show that the Laplace transform of the derivative of a function is expressed in terms of the Laplace transform of the function itself.

```
syms f(t) s
Df = diff(f(t),t);
laplace(Df,t,s)
```

```
ans =
s*laplace(f(t), t, s) - f(0)
```

Laplace Transform of Array Inputs

Find the Laplace transform of the matrix M . Specify the independent and transformation variables for each matrix entry by using matrices of the same size. When the arguments are nonscalars, `laplace` acts on them element-wise.

```
syms a b c d w x y z
M = [exp(x) 1; sin(y) i*z];
vars = [w x; y z];
transVars = [a b; c d];
laplace(M,vars,transVars)
```

```
ans =
[ exp(x)/a, 1/b]
[ 1/(c^2 + 1), 1i/d^2]
```

If `laplace` is called with both scalar and nonscalar arguments, then it expands the scalars to match the nonscalars by using scalar expansion. Nonscalar arguments must be the same size.

```
laplace(x,vars,transVars)
```

```
ans =  
[ x/a, 1/b^2]  
[ x/c,   x/d]
```

Laplace Transform of Symbolic Function

Compute the Laplace transform of symbolic functions. When the first argument contains symbolic functions, then the second argument must be a scalar.

```
syms f1(x) f2(x) a b  
f1(x) = exp(x);  
f2(x) = x;  
laplace([f1 f2],x,[a b])
```

```
ans =  
[ 1/(a - 1), 1/b^2]
```

If Laplace Transform Cannot Be Found

If `laplace` cannot transform the input then it returns an unevaluated call.

```
syms f(t) s  
f(t) = 1/t;  
F = laplace(f,t,s)
```

```
F =  
laplace(1/t, t, s)
```

Return the original expression by using `ilaplace`.

```
ilaplace(F,s,t)
```

```
ans =  
1/t
```

Input Arguments

f — Input

symbolic expression | symbolic function | symbolic vector | symbolic matrix

Input, specified as a symbolic expression, function, vector, or matrix.

var — Independent variable

t (default) | symbolic variable

Independent variable, specified as a symbolic variable. This variable is often called the "time variable" or the "space variable." If you do not specify the variable then, by default, `laplace` uses `t`. If `f` does not contain `t`, then `laplace` uses the function `symvar` to determine the independent variable.

transVar — Transformation variable

s (default) | z | symbolic variable | symbolic expression | symbolic vector | symbolic matrix

Transformation variable, specified as a symbolic variable, expression, vector, or matrix. This variable is often called the "complex frequency variable." If you do not specify the variable then, by default, `laplace` uses `s`. If `s` is the independent variable of `f`, then `laplace` uses `z`.

More About**Laplace Transform**

The Laplace transform $F = F(s)$ of the expression $f = f(t)$ with respect to the variable t at the point s is

$$F(s) = \int_{0^-}^{\infty} f(t) e^{-st} dt.$$

Tips

- If any argument is an array, then `laplace` acts element-wise on all elements of the array.
- If the first argument contains a symbolic function, then the second argument must be a scalar.
- To compute the inverse Laplace transform, use `ilaplace`.

Algorithms

The Laplace transform is defined as a unilateral or one-sided transform. This definition assumes that the signal $f(t)$ is only defined for all real numbers $t \geq 0$, or $f(t) = 0$ for $t < 0$. Therefore, for a generalized signal with $f(t) \neq 0$ for $t < 0$, the Laplace transform of $f(t)$ gives the same result as if $f(t)$ is multiplied by a Heaviside step function.

For example, both of these code blocks:

```
syms t;
laplace(sin(t))
```

and

```
syms t;
laplace(sin(t)*heaviside(t))
```

```
return 1/(s^2 + 1).
```

See Also

`fourier` | `ifourier` | `ilaplace` | `iztrans` | `ztrans`

Topics

"Solve Differential Equations Using Laplace Transform" on page 2-218

Introduced before R2006a

laplacian

Laplacian of scalar function

Syntax

```
laplacian(f,x)  
laplacian(f)
```

Description

`laplacian(f,x)` computes the Laplacian of the scalar function or functional expression `f` with respect to the vector `x` in Cartesian coordinates.

`laplacian(f)` computes the Laplacian of the scalar function or functional expression `f` with respect to a vector constructed from all symbolic variables found in `f`. The order of variables in this vector is defined by `symvar`.

Examples

Compute Laplacian of Symbolic Expression

Compute the Laplacian of this symbolic expression. By default, `laplacian` computes the Laplacian of an expression with respect to a vector of all variables found in that expression. The order of variables is defined by `symvar`.

```
syms x y t  
laplacian(1/x^3 + y^2 - log(t))
```

```
ans =  
1/t^2 + 12/x^5 + 2
```

Compute Laplacian of Symbolic Function

Create this symbolic function:

```
syms x y z  
f(x, y, z) = 1/x + y^2 + z^3;
```

Compute the Laplacian of this function with respect to the vector `[x, y, z]`:

```
L = laplacian(f, [x y z])
```

```
L(x, y, z) =  
6*z + 2/x^3 + 2
```

Input Arguments

f — Input

symbolic expression | symbolic function

Input, specified as a symbolic expression or function.

x – Input

vector of symbolic variables

Input, specified as a vector of symbolic variables. The Laplacian is computed with respect to these symbolic variables.

More About**Laplacian of Scalar Function**

The Laplacian of the scalar function or functional expression f with respect to the vector $X = (X_1, \dots, X_n)$ is the sum of the second derivatives of f with respect to X_1, \dots, X_n :

$$\Delta f = \sum_{i=1}^n \frac{\partial^2 f}{\partial x_i^2}$$

Tips

- If x is a scalar, `laplacian(f, x) = diff(f, 2, x)`.

Alternatives

The Laplacian of a scalar function or functional expression is the divergence of the gradient of that function or expression:

$$\Delta f = \nabla \cdot (\nabla f)$$

Therefore, you can compute the Laplacian using the divergence and gradient functions:

```
syms f(x, y)
divergence(gradient(f(x, y)), [x y])
```

See Also

`curl` | `diff` | `divergence` | `gradient` | `hessian` | `jacobian` | `potential` | `vectorPotential`

Introduced in R2012a

latex

LaTeX form of symbolic expression

Syntax

```
chr = latex(S)
```

Description

`chr = latex(S)` returns the LaTeX form of the symbolic expression `S`.

Examples

LaTeX Form of Symbolic Expression

Find the LaTeX form of the symbolic expressions $x^2 + 1/x$ and $\sin(\pi*x) + \alpha$.

```
syms x phi
chr = latex(x^2 + 1/x)
chr = latex(sin(pi*x) + phi)

chr =
    '\frac{1}{x}+x^2'

chr =
    '\phi +\sin\left(\pi \ ,x\right)'
```

LaTeX Form of Symbolic Matrix

Find the LaTeX form of the symbolic matrix `M`.

```
syms x
M = [sym(1)/3 x; exp(x) x^2]
chrM = latex(M)

M =
 [ 1/3, x]
 [ exp(x), x^2]

chrM =
    '\left(\begin{array}{cc} \frac{1}{3} & x \\ \mathrm{e}^x & x^2 \end{array}\right)'
```

Modify Generated LaTeX with Symbolic Preferences

Modify generated LaTeX by setting symbolic preferences using the `sympref` function.

Generate the LaTeX form of the expression π with the default symbolic preference.

```
sympref('default');
chr = latex(sym(pi))

chr =
    '\pi '
```

Set the 'FloatingPointOutput' preference to `true` to return symbolic output in floating-point format. Generate the LaTeX form of π in floating-point format.

```
sympref('FloatingPointOutput',true);
chr = latex(sym(pi))

chr =
    '3.1416'
```

Now change the output order of a symbolic polynomial. Create a symbolic polynomial and set 'PolynomialDisplayStyle' preference to 'ascend'. Generate LaTeX form of the polynomial sorted in ascending order.

```
syms x;
poly = x^2 - 2*x + 1;
sympref('PolynomialDisplayStyle','ascend');
chr = latex(poly)

chr =
    '1-2\,x+x^2'
```

The preferences you set using `sympref` persist through your current and future MATLAB sessions. Restore the default values by specifying the 'default' option.

```
sympref('default');
```

Use LaTeX to Format Title, Axis Labels, and Ticks

For x and y from -2π to 2π , plot the 3-D surface $y\sin(x) - x\cos(y)$. Store the axes handle in `a` by using `gca`. Display the axes box by using `a.Box` and set the tick label interpreter to `latex`.

Create the x-axis ticks by spanning the x-axis limits at intervals of $\pi/2$. Convert the axis limits to precise multiples of $\pi/2$ using `round` and get the symbolic tick values in `S`. Display the ticks by setting the `XTick` property of `a` to `S`. Create the LaTeX labels for the x-axis by using `arrayfun` to apply `latex` to `S` and then concatenating `$`. Display the labels by assigning them to the `XTickLabel` property of `a`.

Repeat these steps for the y-axis. Set the x- and y-axes labels and the title using the `latex` interpreter.

```
syms x y
f = y.*sin(x)-x.*cos(y);
fsurf(f,[-2*pi 2*pi])
a = gca;
a.TickLabelInterpreter = 'latex';
a.Box = 'on';
a.BoxStyle = 'full';

S = sym(a.XLim(1):pi/2:a.XLim(2));
S = sym(round(vpa(S/pi*2))*pi/2);
```

```

a.XTick = double(S);
a.XTickLabel = strcat('$',arrayfun(@latex, S, 'UniformOutput', false),'$');

S = sym(a.YLim(1):pi/2:a.YLim(2));
S = sym(round(vpa(S/pi*2))*pi/2);
a.YTick = double(S);
a.YTickLabel = strcat('$',arrayfun(@latex, S, 'UniformOutput', false),'$');

xlabel('x','Interpreter','latex');
ylabel('y','Interpreter','latex');
zlabel('z','Interpreter','latex');
title(['$' latex(f) '$ for $x$ and $y$ in $[-2\pi,2\pi]$'],'Interpreter','latex')

```

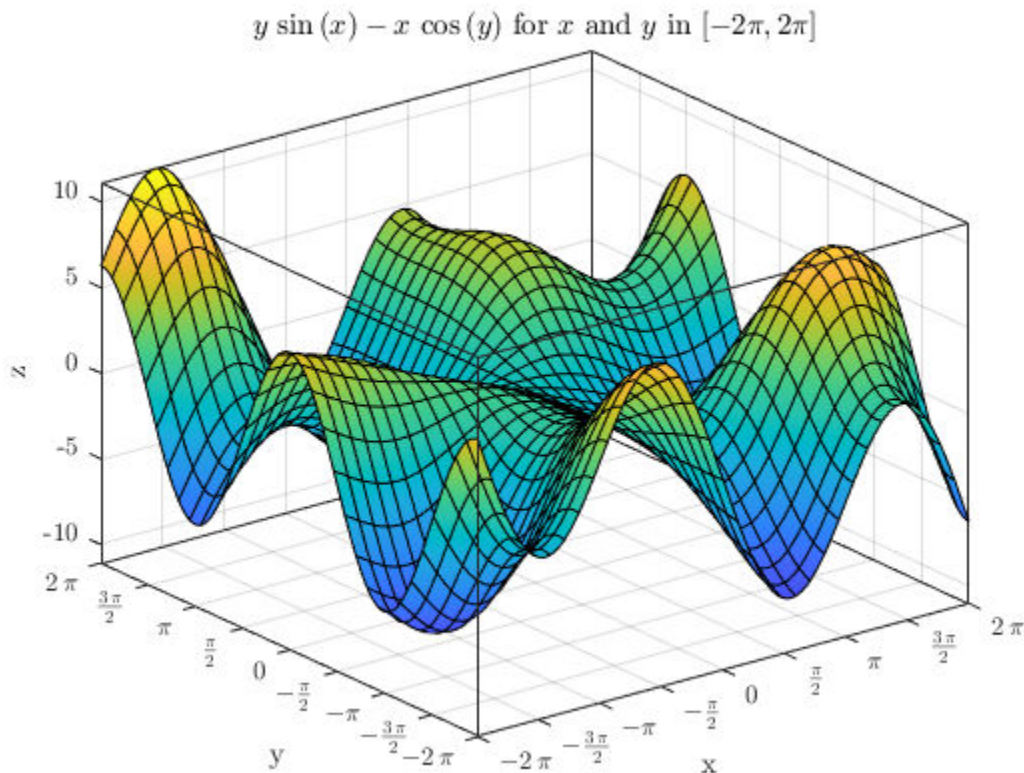

Input Arguments

S — Input

symbolic number | symbolic variable | symbolic vector | symbolic matrix | symbolic multidimensional array | symbolic function | symbolic expression

Input, specified as a symbolic number, variable, vector, matrix, multidimensional array, function, or expression.

See Also

`ccode` | `fortran` | `mathml` | `sympref` | `texlabel`

Introduced before R2006a

lcm

Least common multiple

Syntax

```
lcm(A)
lcm(A, B)
```

Description

`lcm(A)` finds the least common multiple of all elements of `A`.

`lcm(A, B)` finds the least common multiple of `A` and `B`.

Examples

Least Common Multiple of Four Integers

To find the least common multiple of three or more values, specify those values as a symbolic vector or matrix.

Find the least common multiple of these four integers, specified as elements of a symbolic vector.

```
A = sym([4420, -128, 8984, -488])
lcm(A)
```

```
A =
[ 4420, -128, 8984, -488]
```

```
ans =
9689064320
```

Alternatively, specify these values as elements of a symbolic matrix.

```
A = sym([4420, -128; 8984, -488])
lcm(A)
```

```
A =
[ 4420, -128]
[ 8984, -488]
```

```
ans =
9689064320
```

Least Common Multiple of Rational Numbers

`lcm` lets you find the least common multiple of symbolic rational numbers.

Find the least common multiple of these rational numbers, specified as elements of a symbolic vector.

```
lcm(sym([3/4, 7/3, 11/2, 12/3, 33/4]))
```

```
ans =
924
```

Least Common Multiple of Complex Numbers

`lcm` lets you find the least common multiple of symbolic complex numbers.

Find the least common multiple of these complex numbers, specified as elements of a symbolic vector.

```
lcm(sym([10 - 5*i, 20 - 10*i, 30 - 15*i]))
```

```
ans =
- 60 + 30i
```

Least Common Multiple of Elements of Matrices

For vectors and matrices, `lcm` finds the least common multiples element-wise. Nonscalar arguments must be the same size.

Find the least common multiples for the elements of these two matrices.

```
A = sym([309, 186; 486, 224]);
B = sym([558, 444; 1024, 1984]);
lcm(A,B)
```

```
ans =
[ 57474, 13764]
[ 248832, 13888]
```

Find the least common multiples for the elements of matrix A and the value 99. Here, `lcm` expands 99 into the 2-by-2 matrix with all elements equal to 99.

```
lcm(A,99)
```

```
ans =
[ 10197, 6138]
[ 5346, 22176]
```

Least Common Multiple of Polynomials

Find the least common multiple of univariate and multivariate polynomials.

Find the least common multiple of these univariate polynomials.

```
syms x
lcm(x^3 - 3*x^2 + 3*x - 1, x^2 - 5*x + 4)
```

```
ans =
(x - 4)*(x^3 - 3*x^2 + 3*x - 1)
```

Find the least common multiple of these multivariate polynomials. Because there are more than two polynomials, specify them as elements of a symbolic vector.

```
syms x y
lcm([x^2*y + x^3, (x + y)^2, x^2 + x*y^2 + x*y + x + y^3 + y])
```

```
ans =
(x^3 + y*x^2)*(x^2 + x*y^2 + x*y + x + y^3 + y)
```

Input Arguments

A — Input value

number | symbolic number | symbolic variable | symbolic expression | symbolic function | symbolic vector | symbolic matrix

Input value, specified as a number, symbolic number, variable, expression, function, or a vector or matrix of numbers, symbolic numbers, variables, expressions, or functions.

B — Input value

number | symbolic number | symbolic variable | symbolic expression | symbolic function | symbolic vector | symbolic matrix

Input value, specified as a number, symbolic number, variable, expression, function, or a vector or matrix of numbers, symbolic numbers, variables, expressions, or functions.

Tips

- Calling `lcm` for numbers that are not symbolic objects invokes the MATLAB `lcm` function.
- The MATLAB `lcm` function does not accept rational or complex arguments. To find the least common multiple of rational or complex numbers, convert these numbers to symbolic objects by using `sym`, and then use `lcm`.
- Nonscalar arguments must have the same size. If one input arguments is nonscalar, then `lcm` expands the scalar into a vector or matrix of the same size as the nonscalar argument, with all elements equal to the corresponding scalar.

See Also

`gcd`

Introduced in R2014b

ldivide, \

Symbolic array left division

Syntax

```
B.\A
ldivide(B,A)
```

Description

`B.\A` divides `A` by `B`.

`ldivide(B,A)` is equivalent to `B.\A`.

Examples

Divide Scalar by Matrix

Create a 2-by-3 matrix.

```
B = sym('b', [2 3])

B =
[ b1_1, b1_2, b1_3]
[ b2_1, b2_2, b2_3]
```

Divide the symbolic expression `sin(a)` by each element of the matrix `B`.

```
syms a
B.\sin(a)

ans =
[ sin(a)/b1_1, sin(a)/b1_2, sin(a)/b1_3]
[ sin(a)/b2_1, sin(a)/b2_2, sin(a)/b2_3]
```

Divide Matrix by Matrix

Create a 3-by-3 symbolic Hilbert matrix and a 3-by-3 diagonal matrix.

```
H = sym(hilb(3))
d = diag(sym([1 2 3]))

H =
[ 1, 1/2, 1/3]
[ 1/2, 1/3, 1/4]
[ 1/3, 1/4, 1/5]

d =
[ 1, 0, 0]
[ 0, 2, 0]
[ 0, 0, 3]
```

Divide d by H by using the elementwise left division operator `./`. This operator divides each element of the first matrix by the corresponding element of the second matrix. The dimensions of the matrices must be the same.

```
H.\d
```

```
ans =  
[ 1, 0, 0]  
[ 0, 6, 0]  
[ 0, 0, 15]
```

Divide Expression by Symbolic Function

Divide a symbolic expression by a symbolic function. The result is a symbolic function.

```
syms f(x)  
f(x) = x^2;  
f1 = f.\(x^2 + 5*x + 6)
```

```
f1(x) =  
(x^2 + 5*x + 6)/x^2
```

Input Arguments

A — Input

symbolic variable | symbolic vector | symbolic matrix | symbolic multidimensional array | symbolic function | symbolic expression

Input, specified as a symbolic variable, vector, matrix, multidimensional array, function, or expression. Inputs A and B must be the same size unless one is a scalar. A scalar value expands into an array of the same size as the other input.

B — Input

symbolic variable | symbolic vector | symbolic matrix | symbolic multidimensional array | symbolic function | symbolic expression

Input, specified as a symbolic variable, vector, matrix, multidimensional array, function, or expression. Inputs A and B must be the same size unless one is a scalar. A scalar value expands into an array of the same size as the other input.

See Also

`ctranspose` | `minus` | `mldivide` | `mpower` | `mrdivide` | `mtimes` | `plus` | `power` | `rdivide` | `times` | `transpose`

Introduced before R2006a

le

Define less than or equal to condition

Syntax

```
A <= B
le(A,B)
```

Description

$A \leq B$ defines the condition less than or equal to.

`le(A,B)` is equivalent to $A \leq B$.

Examples

Set and Use Assumption Using Less Than or Equal To

Set the assumption that x is less than or equal to 3 by using `assume`.

```
syms x
cond = x <= 3;
assume(cond)
```

Solve an equation for x . The solver only returns solutions that are valid under the assumption on x .

```
eqn = (x-1)*(x-2)*(x-3)*(x-4) == 0;
solve(eqn,x)
```

```
ans =
 1
 2
 3
```

Find Values that Satisfy Condition

Set the condition $\text{abs}(\sin(x)) \leq 1/2$.

```
syms x
cond = abs(sin(x)) <= 1/2;
```

Find multiples of $\pi/24$ that satisfy the condition by using a `for` loop from 0 to π .

```
for i = 0:sym(pi/12):sym(pi)
    if subs(cond, x, i)
        disp(i)
    end
end

0
pi/12
pi/6
```

```
(5*pi)/6  
(11*pi)/12  
pi
```

Input Arguments

A — Input

number | vector | matrix | array | symbolic number | symbolic variable | symbolic array | symbolic function | symbolic expression

Input, specified as a number, vector, matrix, or array, or a symbolic number, variable, array, function, or expression.

B — Input

number | vector | matrix | array | symbolic number | symbolic variable | symbolic array | symbolic function | symbolic expression

Input, specified as a number, vector, matrix, or array, or a symbolic number, variable, array, function, or expression.

Tips

- Calling `<=` or `le` for non-symbolic `A` and `B` invokes the MATLAB `le` function. This function returns a logical array with elements set to logical 1 (`true`) where `A` is less than or equal to `B`; otherwise, it returns logical 0 (`false`).
- If both `A` and `B` are arrays, then these arrays must have the same dimensions. `A <= B` returns an array of relations `A(i,j,...) <= B(i,j,...)`.
- If one input is scalar and the other an array, then the scalar input is expanded into an array of the same dimensions as the other array.
- The field of complex numbers is not an ordered field. MATLAB projects complex numbers in relations to the real axis. For example, `x <= i` becomes `x <= 0`, and `x <= 3 + 2*i` becomes `x <= 3`.

See Also

`eq` | `ge` | `gt` | `isAlways` | `lt` | `ne`

Topics

“Set Assumptions” on page 1-24

Introduced in R2012a

legendreP

Legendre polynomials

Syntax

`legendreP(n,x)`

Description

`legendreP(n,x)` returns the n th degree Legendre polynomial on page 4-896 at x .

Examples

Find Legendre Polynomials for Numeric and Symbolic Inputs

Find the Legendre polynomial of degree 3 at 5.6.

```
legendreP(3,5.6)
```

```
ans =
    430.6400
```

Find the Legendre polynomial of degree 2 at x .

```
syms x
legendreP(2,x)
```

```
ans =
(3*x^2)/2 - 1/2
```

If you do not specify a numerical value for the degree n , the `legendreP` function cannot find the explicit form of the polynomial and returns the function call.

```
syms n
legendreP(n,x)
```

```
ans =
legendreP(n, x)
```

Find Legendre Polynomial with Vector and Matrix Inputs

Find the Legendre polynomials of degrees 1 and 2 by setting $n = [1 \ 2]$.

```
syms x
legendreP([1 2],x)
```

```
ans =
[ x, (3*x^2)/2 - 1/2]
```

`legendreP` acts element-wise on n to return a vector with two elements.

If multiple inputs are specified as a vector, matrix, or multidimensional array, the inputs must be the same size. Find the Legendre polynomials where input arguments n and x are matrices.

```
n = [2 3; 1 2];
xM = [x^2 11/7; -3.2 -x];
legendreP(n,xM)

ans =
[ (3*x^4)/2 - 1/2,          2519/343]
[          -16/5, (3*x^2)/2 - 1/2]
```

legendreP acts element-wise on n and x to return a matrix of the same size as n and x.

Differentiate and Find Limits of Legendre Polynomials

Use limit to find the limit of a Legendre polynomial of degree 3 as x tends to $-\infty$.

```
syms x
expr = legendreP(4,x);
limit(expr,x,-Inf)
```

```
ans =
Inf
```

Use diff to find the third derivative of the Legendre polynomial of degree 5.

```
syms n
expr = legendreP(5,x);
diff(expr,x,3)
```

```
ans =
(945*x^2)/2 - 105/2
```

Find Taylor Series Expansion of Legendre Polynomial

Use taylor to find the Taylor series expansion of the Legendre polynomial of degree 2 at $x = 0$.

```
syms x
expr = legendreP(2,x);
taylor(expr,x)
```

```
ans =
(3*x^2)/2 - 1/2
```

Plot Legendre Polynomials

Plot Legendre polynomials of orders 1 through 4.

```
syms x y
fplot(legendreP(1:4, x))
axis([-1.5 1.5 -1 1])
grid on

ylabel('P_n(x)')
title('Legendre polynomials of degrees 1 through 4')
legend('1','2','3','4','Location','best')
```

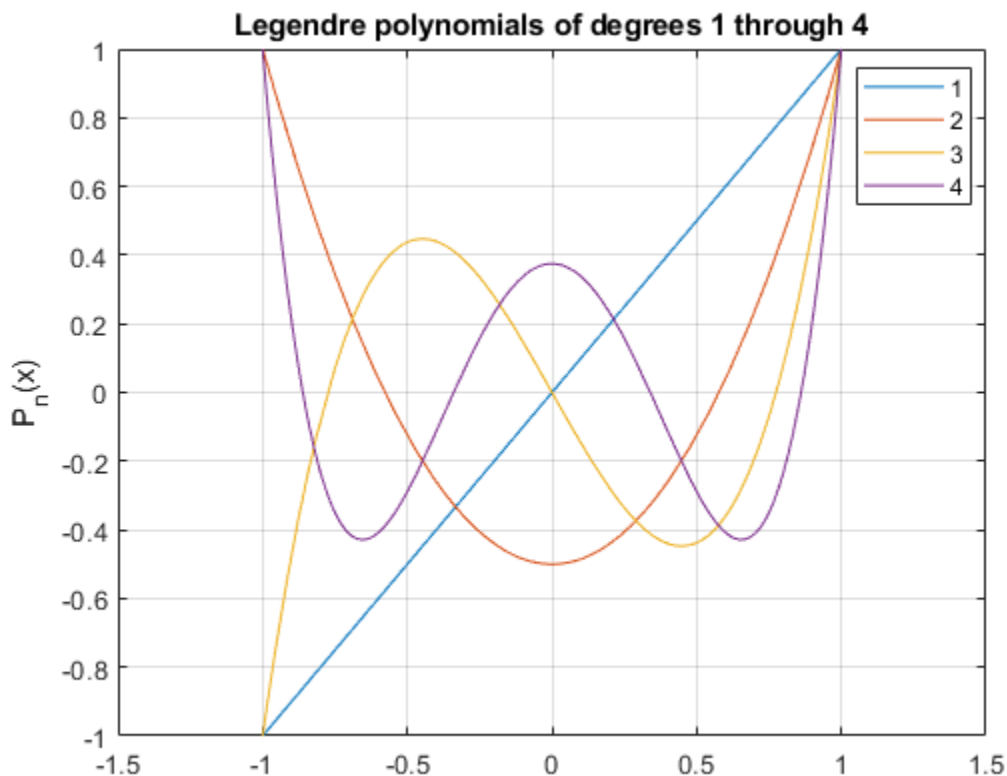

Find Roots of Legendre Polynomial

Use `vpasolve` to find the roots of the Legendre polynomial of degree 7.

```
syms x
roots = vpasolve(legendreP(7,x) == 0)

roots =
-0.94910791234275852452618968404785
-0.74153118559939443986386477328079
-0.40584515137739716690660641207696
      0
 0.40584515137739716690660641207696
 0.74153118559939443986386477328079
 0.94910791234275852452618968404785
```

Input Arguments

n — Degree of polynomial

nonnegative number | vector | matrix | multidimensional array | symbolic number | symbolic vector | symbolic matrix | symbolic function | symbolic multidimensional array

Degree of polynomial, specified as a nonnegative number, vector, matrix, multidimensional array, or a symbolic number, vector, matrix, function, or multidimensional array. All elements of nonscalar inputs should be nonnegative integers or symbols.

x – Input

number | vector | matrix | multidimensional array | symbolic number | symbolic vector | symbolic matrix | symbolic function | symbolic multidimensional array

Input, specified as a number, vector, matrix, multidimensional array, or a symbolic number, vector, matrix, function, or multidimensional array.

More About**Legendre Polynomial**

- The Legendre polynomials are defined as

$$P(n, x) = \frac{1}{2^n n!} \frac{d^n}{dx^n} (x^2 - 1)^n.$$

- The Legendre polynomials satisfy the recursion formula

$$P(n, x) = \frac{2n-1}{n} x P(n-1, x) - \frac{n-1}{n} P(n-2, x),$$

where

$$P(0, x) = 1$$

$$P(1, x) = x.$$

- The Legendre polynomials are orthogonal on the interval $[-1, 1]$ with respect to the weight function $w(x) = 1$, where

$$\int_{x=-1}^{x=1} P(n, x) P(m, x) dx = \begin{cases} 0 & \text{if } n \neq m \\ \frac{1}{n+1/2} & \text{if } n = m. \end{cases}$$

- The relation with Gegenbauer polynomials $G(n, a, x)$ is

$$P(n, x) = G\left(n, \frac{1}{2}, x\right).$$

- The relation with Jacobi polynomials $P(n, a, b, x)$ is

$$P(n, x) = P(n, 0, 0, x).$$

See Also

chebyshevT | chebyshevU | gegenbauerC | hermiteH | hypergeom | jacobiP | laguerreL

Introduced in R2014b

lhs

Left side (LHS) of equation

Syntax

`lhs(eqn)`

Description

`lhs(eqn)` returns the left side of the symbolic equation `eqn`. The value of `eqn` also can be a symbolic condition, such as $x > 0$. If `eqn` is an array, then `lhs` returns an array of the left sides of the equations in `eqn`.

Examples

Find Left Side of Equation

Find the left side of the equation $2*y == x^2$ by using `lhs`.

First, declare the equation.

```
syms x y
eqn = 2*y == x^2
```

```
eqn =
2*y == x^2
```

Find the left side of `eqn` by using `lhs`.

```
lhsEqn = lhs(eqn)
```

```
lhsEqn =
2*y
```

Find Left Side of Condition

Find the left side of the condition $x + y < 1$ by using `lhs`.

First, declare the condition.

```
syms x y
cond = x + y < 1
```

```
cond =
x + y < 1
```

Find the left side of `cond` by using `lhs`.

```
lhsCond = lhs(cond)
```

```
lhsCond =
x + y
```

Note Conditions that use the $>$ operator are internally rewritten using the $<$ operator. Therefore, `lhs` returns the original right side. For example, `lhs(x > a)` returns `a`.

Find Left Side of Equations in Array

For an array that contains equations and conditions, `lhs` returns an array of the left sides of those equations or conditions. The output array is the same size as the input array.

Find the left side of the equations and conditions in the vector `V`.

```
syms x y
V = [y^2 == x^2, x ~= 0, x*y >= 1]
```

```
V =
[ y^2 == x^2, x ~= 0, 1 <= x*y]
```

```
lhsV = lhs(V)
```

```
lhsV =
[ y^2, x, 1]
```

Because any condition using the $>=$ operator is internally rewritten using the $<=$ operator, the sides of the last condition in `V` are exchanged.

Input Arguments

eqn — Equation or condition

symbolic equation | symbolic condition | vector of symbolic equations or conditions | matrix of symbolic equations or conditions | multidimensional array of symbolic equations or conditions

Equation or condition, specified as a symbolic equation or condition, or a vector, matrix, or multidimensional array of symbolic equations or conditions.

See Also

`assume` | `children` | `rhs` | `subs`

Introduced in R2017a

limit

Limit of symbolic expression

Syntax

```
limit(f,var,a)
limit(f,a)
limit(f)

limit(f,var,a,'left')

limit(f,var,a,'right')
```

Description

`limit(f,var,a)` returns the “Bidirectional Limit” on page 4-900 of the symbolic expression f when var approaches a .

`limit(f,a)` uses the default variable found by `symvar`.

`limit(f)` returns the limit at θ .

`limit(f,var,a,'left')` returns the “Left Side Limit” on page 4-900 of f as var approaches a .

`limit(f,var,a,'right')` returns the “Right Side Limit” on page 4-901 of f as var approaches a .

Examples

Limit of Symbolic Expression

Calculate the bidirectional limit of this symbolic expression as x approaches θ .

```
syms x h
f = sin(x)/x;
limit(f,x,theta)
```

```
ans =
1
```

Calculate the limit of this expression as h approaches θ .

```
f = (sin(x+h)-sin(x))/h;
limit(f,h,theta)
```

```
ans =
cos(x)
```

Right and Left Limits of Symbolic Expression

Calculate the right and left limits of symbolic expressions.

```
syms x
f = 1/x;
limit(f,x,0,'right')

ans =
Inf

limit(f,x,0,'left')

ans =
-Inf
```

Limit of Expressions in Symbolic Vector

Calculate the limit of expressions in a symbolic vector. `limit` acts element-wise on the vector.

```
syms x a
V = [(1+a/x)^x exp(-x)];
limit(V,x,Inf)

ans =
[ exp(a), 0]
```

Input Arguments

f — Input

symbolic expression | symbolic function | symbolic vector | symbolic matrix

Input, specified as a symbolic expression, function, vector, or matrix.

var — Independent variable

x (default) | symbolic variable

Independent variable, specified as a symbolic variable. If you do not specify `var`, then `symvar` determines the independent variable.

a — Limit point

number | symbolic number | symbolic variable | symbolic expression

Limit point, specified as a number or a symbolic number, variable, or expression.

More About

Bidirectional Limit

$$L = \lim_{x \rightarrow a} f(x), x - a \in \mathbb{R} \setminus \{0\}.$$

Left Side Limit

$$L = \lim_{x \rightarrow a^-} f(x), x - a < 0.$$

Right Side Limit

$$L = \lim_{x \rightarrow a^+} f(x), x - a > 0.$$

See Also

diff | poles | taylor

Introduced before R2006a

linsolve

Solve linear equations in matrix form

Syntax

```
X = linsolve(A,B)
[X,R] = linsolve(A,B)
```

Description

`X = linsolve(A,B)` solves the matrix equation $AX = B$, where B is a column vector.

`[X,R] = linsolve(A,B)` also returns the reciprocal of the condition number of A if A is a square matrix. Otherwise, `linsolve` returns the rank of A .

Examples

Solve Linear Equations in Matrix Form

Solve this system of linear equations in matrix form by using `linsolve`.

$$\begin{bmatrix} 2 & 1 & 1 \\ -1 & 1 & -1 \\ 1 & 2 & 3 \end{bmatrix} \begin{bmatrix} x \\ y \\ z \end{bmatrix} = \begin{bmatrix} 2 \\ 3 \\ -10 \end{bmatrix}$$

```
A = [ 2 1 1;
     -1 1 -1;
     1 2 3];
B = [2; 3; -10];
X = linsolve(A,B)
```

```
X =
     3
     1
    -5
```

From X , $x = 3$, $y = 1$ and $z = -5$.

Compute Condition Number of Square Matrix

Compute the reciprocal of the condition number of the square coefficient matrix by using two output arguments.

```
syms a x y z
A = [a 0 0; 0 a 0; 0 0 1];
B = [x; y; z];
[X, R] = linsolve(A, B)
```

```
X =
  x/a
  y/a
  z
```

```
R =
1/(max(abs(a), 1)*max(1/abs(a), 1))
```

Compute Rank of Nonsquare Matrix

If the coefficient matrix is rectangular, `linsolve` returns the rank of the coefficient matrix as the second output argument. Show this behavior.

```
syms a b x y
A = [a 0 1; 1 b 0];
B = [x; y];
[X, R] = linsolve(A, B)
```

Warning: Solution is not unique because the system is rank-deficient.

```
In sym.linsolve at 67
```

```
X =
      x/a
-(x - a*y)/(a*b)
      0
```

```
R =
2
```

Input Arguments

A — Coefficient matrix

symbolic matrix

Coefficient matrix, specified as a symbolic matrix.

B — Right side of equations

symbolic vector | symbolic matrix

Right side of equations, specified as a symbolic vector or matrix.

Output Arguments

X — Solution

symbolic vector | symbolic matrix

Solution, returned as a symbolic vector or matrix.

R — Reciprocal condition number or rank

symbolic number | symbolic expression

Reciprocal condition number or rank, returned as a symbolic number of expression. If A is a square matrix, `linsolve` returns the condition number of A. Otherwise, `linsolve` returns the rank of A.

More About

Matrix Representation of System of Linear Equations

A system of linear equations is as follows.

$$\begin{aligned} a_{11}x_1 + a_{12}x_2 + \dots + a_{1n}x_n &= b_1 \\ a_{21}x_1 + a_{22}x_2 + \dots + a_{2n}x_n &= b_2 \\ &\dots \\ a_{m1}x_1 + a_{m2}x_2 + \dots + a_{mn}x_n &= b_m \end{aligned}$$

This system can be represented as the matrix equation $A \cdot \vec{x} = \vec{b}$, where A is the coefficient matrix.

$$A = \begin{pmatrix} a_{11} & \dots & a_{1n} \\ \vdots & \ddots & \vdots \\ a_{m1} & \dots & a_{mn} \end{pmatrix}$$

\vec{b} is the vector containing the right sides of equations.

$$\vec{b} = \begin{pmatrix} b_1 \\ \vdots \\ b_m \end{pmatrix}$$

Tips

- If the solution is not unique, `linsolve` issues a warning, chooses one solution, and returns it.
- If the system does not have a solution, `linsolve` issues a warning and returns `X` with all elements set to `Inf`.
- Calling `linsolve` for numeric matrices that are not symbolic objects invokes the MATLAB `linsolve` function. This function accepts real arguments only. If your system of equations uses complex numbers, use `sym` to convert at least one matrix to a symbolic matrix, and then call `linsolve`.

See Also

`cond` | `dsolve` | `equationsToMatrix` | `inv` | `norm` | `odeToVectorField` | `rank` | `solve` | `symvar` | `vpasolve`

Topics

“Solve System of Algebraic Equations” on page 2-160

Introduced in R2012b

log

Natural logarithm of entries of symbolic matrix

Syntax

```
Y = log(X)
```

Description

$Y = \log(X)$ returns the natural logarithm of X .

Examples

Compute Natural Logarithm

Compute the natural logarithm of each entry of this symbolic matrix:

```
syms x
M = x*hilb(2);
log(M)

ans =
[ log(x), log(x/2)]
[ log(x/2), log(x/3)]
```

Differentiate Symbolic Expression

Differentiate this symbolic expression:

```
syms x
diff(log(x^3), x)

ans =
3/x
```

Input Arguments

X — Input

number | vector | matrix | array | symbolic number | symbolic variable | symbolic array | symbolic function | symbolic expression

Input, specified as a number, vector, matrix, or array, or a symbolic number, variable, array, function, or expression.

See Also

log10 | log2

Introduced before R2006a

log10

Log base 10 of symbolic input

Syntax

```
log10(x)
```

Description

`log10(x)` returns the logarithm to the base 10 of x . If x is an array, `log10` acts element-wise on x .

Examples

Log Base 10 of Numeric and Symbolic Input

Compute the log base 10 of numeric input.

```
log10(20)
```

```
ans =  
    1.3010
```

Compute the log base 10 of symbolic input. The result is in terms of `log`.

```
syms x  
f = x^2;  
fLog10 = log10(f)
```

```
fLog10 =  
log(x^2)/log(10)
```

Convert symbolic output to double by substituting for x with a number using `subs`, and then using `double`.

```
fLog10 = subs(fLog10,x,5);           % x is 5  
fLog10 = double(fLog10)
```

```
fLog10 =  
    1.3979
```

Input Arguments

x — Input

number | vector | matrix | array | symbolic number | symbolic variable | symbolic array | symbolic function | symbolic expression

Input, specified as a number, vector, matrix, or array, or a symbolic number, variable, array, function, or expression.

See Also

log | log2

Introduced before R2006a

log2

Log base 2 of symbolic input

Syntax

```
log2(x)
```

Description

`log2(x)` returns the logarithm to the base 2 of x . If x is an array, `log2` acts element-wise on x .

Examples

Log Base 2 of Numeric and Symbolic Input

Compute the log base 2 of numeric input.

```
log2(20)
```

```
ans =  
    4.3219
```

Compute the log base 2 of symbolic input. The result is in terms of `log`.

```
syms x  
f = x^2;  
fLog2 = log2(f)
```

```
fLog2 =  
log(x^2)/log(2)
```

Convert symbolic output to double by substituting for x with a number by using `subs`, and then using `double`.

```
fLog2 = subs(fLog2,x,5);           % x is 5  
fLog2 = double(fLog2)
```

```
fLog2 =  
    4.6439
```

Input Arguments

x — Input

number | vector | matrix | array | symbolic number | symbolic variable | symbolic array | symbolic function | symbolic expression

Input, specified as a number, vector, matrix, or array, or a symbolic number, variable, array, function, or expression.

See Also

log | log10

Introduced before R2006a

logical

Check validity of equation or inequality

Syntax

```
logical(cond)
```

Description

`logical(cond)` checks whether the condition `cond` is valid. To test conditions that require assumptions or simplifications, use `isAlways` instead of `logical`.

Examples

Test Condition Using logical

Use `logical` to check if $3/5$ is less than $2/3$:

```
logical(sym(3)/5 < sym(2)/3)
```

```
ans =  
    logical  
     1
```

Test Equation Using logical

Check the validity of this equation using `logical`. Without an additional assumption that x is nonnegative, this equation is invalid.

```
syms x  
logical(x == sqrt(x^2))
```

```
ans =  
    logical  
     0
```

Use `assume` to set an assumption that x is nonnegative. Now the expression `sqrt(x^2)` evaluates to x , and `logical` returns 1:

```
assume(x >= 0)  
logical(x == sqrt(x^2))
```

```
ans =  
    logical  
     1
```

Note that `logical` typically ignores assumptions on variables.

```
syms x  
assume(x == 5)  
logical(x == 5)
```

```
ans =
  logical
  0
```

To compare expressions taking into account assumptions on their variables, use `isAlways`:

```
isAlways(x == 5)
```

```
ans =
  logical
  1
```

For further computations, clear the assumption on `x` by recreating it using `syms`:

```
syms x
```

Test Multiple Conditions Using `logical`

Check if the following two conditions are both valid. To check if several conditions are valid at the same time, combine these conditions by using the logical operator `and` or its shortcut `&`.

```
syms x
logical(1 < 2 & x == x)
```

```
ans =
  logical
  1
```

Test Inequality Using `logical`

Check this inequality. Note that `logical` evaluates the left side of the inequality.

```
logical(sym(11)/4 - sym(1)/2 > 2)
```

```
ans =
  logical
  1
```

`logical` also evaluates more complicated symbolic expressions on both sides of equations and inequalities. For example, it evaluates the integral on the left side of this equation:

```
syms x
logical(int(x, x, 0, 2) - 1 == 1)
```

```
ans =
  logical
  1
```

Compare `logical` and `isAlways`

Do not use `logical` to check equations and inequalities that require simplification or mathematical transformations. For such equations and inequalities, `logical` might return unexpected results. For example, `logical` does not recognize mathematical equivalence of these expressions:

```
syms x
logical(sin(x)/cos(x) == tan(x))
```

```
ans =
  logical
  0
```

`logical` also does not realize that this inequality is invalid:

```
logical(sin(x)/cos(x) ~= tan(x))
```

```
ans =
    logical
     1
```

To test the validity of equations and inequalities that require simplification or mathematical transformations, use `isAlways`:

```
isAlways(sin(x)/cos(x) == tan(x))
```

```
ans =
    logical
     1
```

```
isAlways(sin(x)/cos(x) ~= tan(x))
```

```
Warning: Unable to prove 'sin(x)/cos(x) ~= tan(x)'.
ans =
```

```
    logical
     0
```

Input Arguments

cond — Input

symbolic equation | symbolic inequality | symbolic array of equations or inequalities

Input, specified as a symbolic equation, inequality, or a symbolic array of equations or inequalities. You also can combine several conditions by using the logical operators `and`, `or`, `xor`, `not`, or their shortcuts.

Tips

- For symbolic equations, `logical` returns logical 1 (**true**) only if the left and right sides are identical. Otherwise, it returns logical 0 (**false**).
- For symbolic inequalities constructed with `~=`, `logical` returns logical 0 (**false**) only if the left and right sides are identical. Otherwise, it returns logical 1 (**true**).
- For all other inequalities (constructed with `<`, `<=`, `>`, or `>=`), `logical` returns logical 1 if it can prove that the inequality is valid and logical 0 if it can prove that the inequality is invalid. If `logical` cannot determine whether such inequality is valid or not, it throws an error.
- `logical` evaluates expressions on both sides of an equation or inequality, but does not simplify or mathematically transform them. To compare two expressions applying mathematical transformations and simplifications, use `isAlways`.
- `logical` typically ignores assumptions on variables.

See Also

`assume` | `assumeAlso` | `assumptions` | `in` | `isAlways` | `isequal` | `isequaln` | `isfinite` | `isinf` | `isnan` | `sym` | `syms`

Topics

“Use Assumptions on Symbolic Variables” on page 1-24

“Clear Assumptions and Reset the Symbolic Engine” on page 2-112

Introduced in R2012a

logint

Logarithmic integral function

Syntax

`A = logint(x)`

Description

`A = logint(x)` evaluates the logarithmic integral function on page 4-916 (integral logarithm).

Examples

Integral Logarithm for Numeric and Symbolic Arguments

`logint` returns floating-point or exact symbolic results depending on the arguments you use.

Compute integral logarithms for these numbers. Because these numbers are not symbolic objects, `logint` returns floating-point results.

```
A = logint([-1, 0, 1/4, 1/2, 1, 2, 10])
```

```
A =
    0.0737 + 3.4227i    0.0000 + 0.0000i   -0.1187 + 0.0000i   -0.3787 + 0.0000i...
    -Inf + 0.0000i    1.0452 + 0.0000i    6.1656 + 0.0000i
```

Compute integral logarithms for the numbers converted to symbolic objects. For many symbolic (exact) numbers, `logint` returns unresolved symbolic calls.

```
symA = logint(sym([-1, 0, 1/4, 1/2, 1, 2, 10]))
```

```
symA =
[ logint(-1), 0, logint(1/4), logint(1/2), -Inf, logint(2), logint(10)]
```

Use `vpa` to approximate symbolic results with floating-point numbers:

```
A = vpa(symA)
```

```
A =
[ 0.07366791204642548599010096523015...
+ 3.4227333787773627895923750617977i,...
0,...
-0.11866205644712310530509570647204,...
-0.37867104306108797672720718463656,...
-Inf,...
1.0451637801174927848445888891946,...
6.1655995047872979375229817526695]
```

Plot Integral Logarithm

Plot the integral logarithm function on the interval from 0 to 10.

```
syms x
fplot(logint(x),[0 10])
grid on
```

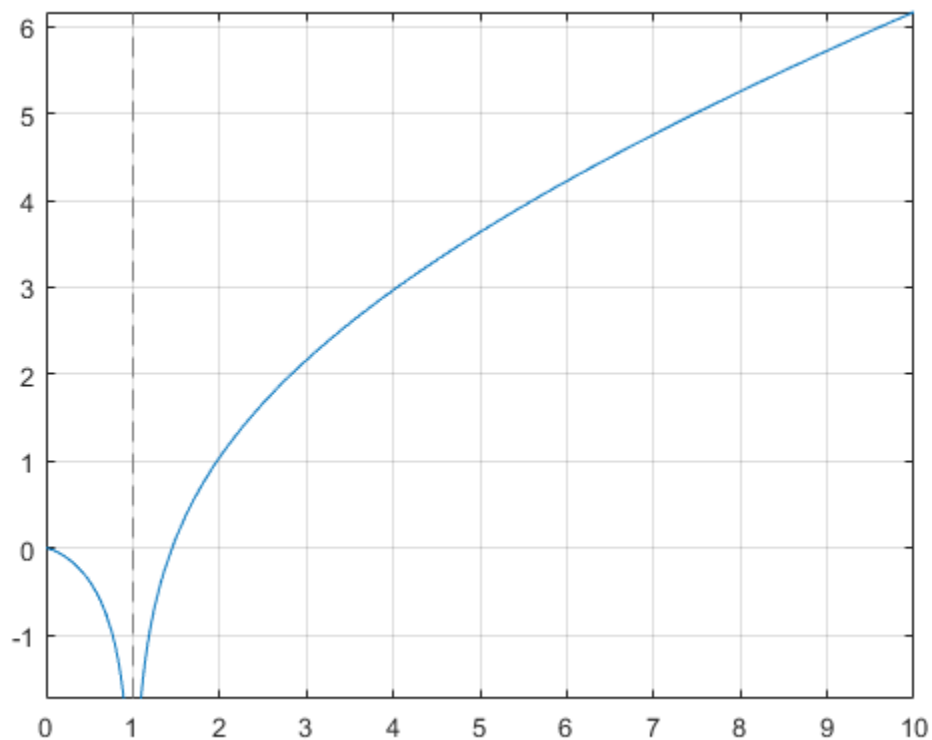

Handle Expressions Containing Integral Logarithm

Many functions, such as `diff` and `limit`, can handle expressions containing `logint`.

Find the first and second derivatives of the integral logarithm:

```
syms x
dA = diff(logint(x), x)
dA = diff(logint(x), x, x)
```

```
dA =
1/log(x)
```

```
dA =
-1/(x*log(x)^2)
```

Find the right and left limits of this expression involving `logint`:

```
A_r = limit(exp(1/x)/logint(x + 1), x, 0, 'right')
```

```
A_r =
Inf
```

```
A_l = limit(exp(1/x)/logint(x + 1), x, 0, 'left')
```

$$\frac{A_l}{\theta} =$$

Input Arguments

x — Input

symbolic number | symbolic variable | symbolic expression | symbolic function | symbolic vector | symbolic matrix

Input, specified as a symbolic number, variable, expression, or function, or as a vector or matrix of symbolic numbers, variables, expressions, or functions.

More About

Logarithmic Integral Function

The logarithmic integral function, also called the integral logarithm, is defined as follows:

$$\operatorname{logint}(x) = \operatorname{li}(x) = \int_0^x \frac{1}{\ln(t)} dt$$

Tips

- `logint(sym(0))` returns 1.
- `logint(sym(1))` returns `-Inf`.
- `logint(z) = ei(log(z))` for all complex z .

References

- [1] Gautschi, W., and W. F. Cahill. "Exponential Integral and Related Functions." *Handbook of Mathematical Functions with Formulas, Graphs, and Mathematical Tables*. (M. Abramowitz and I. A. Stegun, eds.). New York: Dover, 1972.

See Also

`coshint` | `cosint` | `ei` | `expint` | `int` | `log` | `sinhint` | `sinint` | `ssinint`

Introduced in R2014a

logm

Matrix logarithm

Syntax

$R = \text{logm}(A)$

Description

$R = \text{logm}(A)$ computes the matrix logarithm of the square matrix A .

Examples

Matrix Logarithm

Compute the matrix logarithm for the 2-by-2 matrix.

```
syms x
A = [x 1; 0 -x];
logm(A)

ans =
[ log(x), log(x)/(2*x) - log(-x)/(2*x) ]
[      0,                      log(-x) ]
```

Input Arguments

A — Input matrix

square matrix

Input matrix, specified as a square symbolic matrix.

Output Arguments

R — Resulting matrix

symbolic matrix

Resulting function, returned as a symbolic matrix.

See Also

[eig](#) | [expm](#) | [funm](#) | [jordan](#) | [sqrtm](#)

Introduced in R2014b

lt

Define less than relation

Syntax

```
A < B  
lt(A,B)
```

Description

$A < B$ creates a less than relation.

`lt(A,B)` is equivalent to $A < B$.

Examples

Set and Use Assumption Using Less

Use `assume` and the relational operator `<` to set the assumption that x is less than 3:

```
syms x  
assume(x < 3)
```

Solve this equation. The solver takes into account the assumption on variable x , and therefore returns these two solutions.

```
solve((x - 1)*(x - 2)*(x - 3)*(x - 4) == 0, x)
```

```
ans =  
 1  
 2
```

Find Values that Satisfy Condition

Use the relational operator `<` to set this condition on variable x :

```
syms x  
cond = abs(sin(x)) + abs(cos(x)) < 6/5;
```

Use the `for` loop with step $\pi/24$ to find angles from 0 to π that satisfy that condition:

```
for i = 0:sym(pi/24):sym(pi)  
    if subs(cond, x, i)  
        disp(i)  
    end  
end  
  
0  
pi/24  
(11*pi)/24  
pi/2  
(13*pi)/24
```

(23*pi)/24
pi

Input Arguments

A — Input

number | vector | matrix | array | symbolic number | symbolic variable | symbolic array | symbolic function | symbolic expression

Input, specified as a number, vector, matrix, or array, or a symbolic number, variable, array, function, or expression.

B — Input

number | vector | matrix | array | symbolic number | symbolic variable | symbolic array | symbolic function | symbolic expression

Input, specified as a number, vector, matrix, or array, or a symbolic number, variable, array, function, or expression.

Tips

- Calling `<` or `lt` for non-symbolic `A` and `B` invokes the MATLAB `lt` function. This function returns a logical array with elements set to logical 1 (`true`) where `A` is less than `B`; otherwise, it returns logical 0 (`false`).
- If both `A` and `B` are arrays, then these arrays must have the same dimensions. `A < B` returns an array of relations `A(i,j,...) < B(i,j,...)`
- If one input is scalar and the other an array, then the scalar input is expanded into an array of the same dimensions as the other array. In other words, if `A` is a variable (for example, `x`), and `B` is an m -by- n matrix, then `A` is expanded into m -by- n matrix of elements, each set to `x`.
- The field of complex numbers is not an ordered field. MATLAB projects complex numbers in relations to a real axis. For example, `x < i` becomes `x < 0`, and `x < 3 + 2*i` becomes `x < 3`.

See Also

`eq` | `ge` | `gt` | `isAlways` | `le` | `ne`

Topics

“Set Assumptions” on page 1-24

Introduced in R2012a

lu

LU factorization

Syntax

```
[L,U] = lu(A)
[L,U,P] = lu(A)
[L,U,p] = lu(A,'vector')
[L,U,p,q] = lu(A,'vector')
[L,U,P,Q,R] = lu(A)
[L,U,p,q,R] = lu(A,'vector')
lu(A)
```

Description

`[L,U] = lu(A)` returns an upper triangular matrix U and a matrix L , such that $A = L*U$. Here, L is a product of the inverse of the permutation matrix and a lower triangular matrix.

`[L,U,P] = lu(A)` returns an upper triangular matrix U , a lower triangular matrix L , and a permutation matrix P , such that $P*A = L*U$. The syntax `lu(A,'matrix')` is identical.

`[L,U,p] = lu(A,'vector')` returns the permutation information as a vector p , such that $A(p,:) = L*U$.

`[L,U,p,q] = lu(A,'vector')` returns the permutation information as two row vectors p and q , such that $A(p,q) = L*U$.

`[L,U,P,Q,R] = lu(A)` returns an upper triangular matrix U , a lower triangular matrix L , permutation matrices P and Q , and a scaling matrix R , such that $P*(R\A)*Q = L*U$. The syntax `lu(A,'matrix')` is identical.

`[L,U,p,q,R] = lu(A,'vector')` returns the permutation information in two row vectors p and q , such that $R(:,p)\A(:,q) = L*U$.

`lu(A)` returns the matrix that contains the strictly lower triangular matrix L (the matrix without its unit diagonal) and the upper triangular matrix U as submatrices. Thus, `lu(A)` returns the matrix $U + L - \text{eye}(\text{size}(A))$, where L and U are defined as `[L,U,P] = lu(A)`. The matrix A must be square.

Examples

Compute LU Factorization of Matrix

Compute the LU factorization of this matrix. Because the numbers are not symbolic objects, you get floating-point results.

```
M = [2 -3 -1; 1/2 1 -1; 0 1 -1];
[L, U] = lu(M)
```

```
L =
    1.0000    0    0
    0.2500    1.0000    0
    0    0.5714    1.0000
```

```
U =
    2.0000   -3.0000   -1.0000
    0    1.7500   -0.7500
    0    0   -0.5714
```

Now convert this matrix to a symbolic object, and compute the LU factorization.

```
M = sym(M);
[L, U] = lu(M)
```

```
L =
 [ 1, 0, 0]
 [ 1/4, 1, 0]
 [ 0, 4/7, 1]
```

```
U =
 [ 2, -3, -1]
 [ 0, 7/4, -3/4]
 [ 0, 0, -4/7]
```

Compute Lower Triangular, Upper Triangular, and Permutation Matrices

Return the lower and upper triangular matrices and the permutation matrix by providing three output arguments.

```
syms a
[L, U, P] = lu(sym([0 0 a; a 2 3; 0 a 2]))
```

```
L =
 [ 1, 0, 0]
 [ 0, 1, 0]
 [ 0, 0, 1]
```

```
U =
 [ a, 2, 3]
 [ 0, a, 2]
 [ 0, 0, a]
```

```
P =
    0    1    0
    0    0    1
    1    0    0
```

Return Permutation as Vector

Return the permutation information as a vector by using the 'vector' flag.

```
syms a
A = [0 0 a; a 2 3; 0 a 2];
[L, U, p] = lu(A, 'vector')
```

```
L =
 [ 1, 0, 0]
```

```

[ 0, 1, 0]
[ 0, 0, 1]
U =
[ a, 2, 3]
[ 0, a, 2]
[ 0, 0, a]
p =
     2     3     1

```

Check that $A(p, :) = L*U$ by using `isAlways`.

```
isAlways(A(p,:) == L*U)
```

```

ans =
 3x3 logical array
     1     1     1
     1     1     1
     1     1     1

```

Restore the permutation matrix P from the vector p .

```

P = zeros(3, 3);
for i = 1:3
    P(i, p(i)) = 1;
end

```

```
P
```

```

P =
     0     1     0
     0     0     1
     1     0     0

```

Return Permutation as Two Vectors

Return the permutation information as two vectors p and q .

```

syms a
A = [a, 2, 3*a; 2*a, 3, 4*a; 4*a, 5, 6*a];
[L, U, p, q] = lu(A, 'vector')

```

```

L =
[ 1, 0, 0]
[ 2, 1, 0]
[ 4, 3, 1]
U =
[ a, 2, 3*a]
[ 0, -1, -2*a]
[ 0, 0, 0]
p =
     1     2     3
q =
     1     2     3

```

Check that $A(p, q) = L*U$ by using `isAlways`.

```
isAlways(A(p, q) == L*U)
```



```
ans =
  3x3 logical array
   1   1   1
   1   1   1
   1   1   1
```

Compute Scaling Matrix with Other Matrices

Return the lower and upper triangular matrices, permutation matrices, and scaling matrix.

```
syms a
A = [0, a; 1/a, 0; 0, 1/5; 0, -1];
[L, U, P, Q, R] = lu(A)
```

```
L =
 [ 1,      0, 0, 0]
 [ 0,      1, 0, 0]
 [ 0, 1/(5*a), 1, 0]
 [ 0,     -1/a, 0, 1]
```

```
U =
 [ 1/a, 0]
 [ 0, a]
 [ 0, 0]
 [ 0, 0]
```

```
P =
   0   1   0   0
   1   0   0   0
   0   0   1   0
   0   0   0   1
```

```
Q =
   1   0
   0   1
```

```
R =
 [ 1, 0, 0, 0]
 [ 0, 1, 0, 0]
 [ 0, 0, 1, 0]
 [ 0, 0, 0, 1]
```

Check that $P*(R\backslash A)*Q = L*U$ by using `isAlways`.

```
isAlways(P*(R\A)*Q == L*U)
```

```
ans =
  4x2 logical array
   1   1
   1   1
   1   1
   1   1
```

Return Permutation a Two Vectors with Scaling Matrix

Return the permutation information as vectors `p` and `q` by using the `'vector'` flag. Also, compute the scaling matrix `R`.

```

syms a
A = [0, a; 1/a, 0; 0, 1/5; 0, -1];
[L, U, p, q, R] = lu(A, 'vector')

L =
[ 1,      0, 0, 0]
[ 0,      1, 0, 0]
[ 0, 1/(5*a), 1, 0]
[ 0,    -1/a, 0, 1]
U =
[ 1/a, 0]
[ 0, a]
[ 0, 0]
[ 0, 0]
p =
     2     1     3     4
q =
     1     2
R =
[ 1, 0, 0, 0]
[ 0, 1, 0, 0]
[ 0, 0, 1, 0]
[ 0, 0, 0, 1]

```

Check that $R(:,p)\backslash A(:,q) = L*U$ by using `isAlways`.

```
isAlways(R(:,p)\A(:,q) == L*U)
```

```

ans =
 4x2 logical array
     1     1
     1     1
     1     1
     1     1

```

Return Triangular Matrices as Submatrices

Return triangular matrices as submatrices by specifying one or no output arguments.

```

syms a
A = [0 0 a; a 2 3; 0 a 2];
lu(A)

```

```

ans =
[ a, 2, 3]
[ 0, a, 2]
[ 0, 0, a]

```

Verify that the resulting matrix is equal to $U + L - \text{eye}(\text{size}(A))$, where L and U are defined as $[L, U, P] = \text{lu}(A)$.

```

[L,U,P] = lu(A);
U + L - eye(size(A))

```

```

ans =
[ a, 2, 3]

```

```
[ 0, a, 2]
[ 0, 0, a]
```

Input Arguments

A — Input

numeric matrix | symbolic matrix

Input, specified as a numeric or symbolic matrix.

More About

LU Factorization of a Matrix

LU factorization expresses an m -by- n matrix A as $P^*A = L*U$. Here, L is an m -by- m lower triangular matrix, U is an m -by- n upper triangular matrix, and P is a permutation matrix.

Permutation Vector

The permutation vector p contains numbers corresponding to row exchanges in the matrix A . For an m -by- m matrix, p represents the following permutation matrix with indices i and j ranging from 1 to m .

$$P_{ij} = \delta_{p_i, j} = \begin{cases} 1 & \text{if } j = p_i \\ 0 & \text{if } j \neq p_i \end{cases}$$

Tips

- Calling `lu` for numeric arguments that are not symbolic objects invokes the MATLAB `lu` function.
- The `thresh` option supported by the MATLAB `lu` function does not affect symbolic inputs.
- If you use `'matrix'` instead of `'vector'`, then `lu` returns permutation matrices, as it does by default.
- L and U are nonsingular if and only if A is nonsingular. `lu` also can compute the LU factorization of a singular matrix A . In this case, L or U is a singular matrix.
- Most algorithms for computing LU factorization are variants of Gaussian elimination.

See Also

`chol` | `eig` | `isAlways` | `lu` | `qr` | `svd` | `vpa`

Introduced in R2013a

mapSymType

Apply function to symbolic subobjects of specific type

Syntax

```
X = mapSymType(symObj, type, func)
X = mapSymType(symObj, funType, vars, func)
```

Description

`X = mapSymType(symObj, type, func)` applies the function `func` to the symbolic subobjects of type `type` in the symbolic object `symObj`. The input `type` must be a case-sensitive string scalar or character vector, and it can include a logical expression.

- `func` must be a function handle or a symbolic function of type 'symfun'.
- `func` must return a scalar that can be converted to a symbolic object using the `sym` or `str2sym` function.

If `symObj` contains several subexpressions of type `type`, then `mapSymType` applies the function `func` to the largest subexpression.

`X = mapSymType(symObj, funType, vars, func)` applies the function `func` to the unassigned symbolic functions that depend on the variables `vars` in the symbolic object `symObj`.

You can set the function type `funType` to 'symfunOf' or 'symfunDependingOn'. For example, `syms f(x); mapSymType(f, 'symfunOf', x, @(u) cos(u))` returns `cos(f(x))`.

Examples

Apply Function to Symbolic Numbers in Expression

Create a symbolic expression that contains symbolic numbers using `sym`.

```
expr = sym('2') + 1i*pi
expr = 2 +  $\pi i$ 
```

Construct a function handle that computes the square of a number.

```
sq = @(y) y^2;
```

Apply the function `sq` to the symbolic subobject of type 'integer' in the expression `expr`.

```
X = mapSymType(expr, 'integer', sq)
X = 4 +  $\pi i$ 
```

You can also apply an existing MATLAB® function, such as `exp`. Apply the `exp` function to the symbolic subobject of type 'complex' in the expression `expr`.

```
X = mapSymType(expr, 'complex', @exp)
```

$$X = \pi e^i + 2$$

Apply Symbolic Function to Symbolic Subobjects in Equation

Apply a symbolic function to specific subobjects in a symbolic equation.

Create a symbolic equation.

```
syms x t
eq = 0.5*x + sin(x) == t/4
```

$$\text{eq} = \frac{x}{2} + \sin(x) = \frac{t}{4}$$

Construct a symbolic function that multiplies an input by 2.

```
syms f(u)
f(u) = 2*u;
```

Apply the symbolic function f to the symbolic subobjects of type 'variable' in the equation eq.

```
X = mapSymType(eq, 'variable', f)
```

$$X = x + \sin(2x) = \frac{t}{2}$$

The symbolic variables x and t in the equation are multiplied by 2.

You can also apply the same symbolic function that is created using symfun.

```
X = mapSymType(eq, 'variable', symfun(2*u, u))
```

$$X = x + \sin(2x) = \frac{t}{2}$$

Now create an unassigned symbolic function. Apply the unassigned function to the symbolic subobjects of type 'sin' in the equation eq.

```
syms g(u)
X = mapSymType(eq, 'sin', g)
```

$$X = \frac{x}{2} + g(\sin(x)) = \frac{t}{4}$$

Apply Function to Largest Subexpression of Specific Type

Convert the largest symbolic subexpression of specific type in an expression.

Create a symbolic expression.

```
syms f(x) y
expr = sin(x) + f(x) - 2*y
expr = f(x) - 2*y + sin(x)
```

Apply the `log` function to the symbolic subobject of type 'expression' in the expression `expr`.

```
X = mapSymType(expr, 'expression', @log)
X = log(f(x) - 2*y + sin(x))
```

When there are several subexpressions of type 'expression', `mapSymType` applies the `log` function to the largest subexpression.

Symbolic Functions of Specific Variables

Convert unassigned symbolic functions with specific variable dependencies in an expression.

Create a symbolic expression.

```
syms f(x) g(t) h(x,t)
expr = f(x) + 2*g(t) + h(x,t)*sin(x)
expr = 2*g(t) + f(x) + sin(x)*h(x,t)
```

Construct a function handle that converts an input to a symbolic variable with name 'z'.

```
func = @(obj) sym('z');
```

Apply the conversion function `func` to the unassigned symbolic functions in the expression `expr`.

Convert the functions that depend on the exact sequence of variables `[x t]` using 'symfunOf'.

```
X = mapSymType(expr, 'symfunOf', [x t], func)
X = 2*g(t) + f(x) + z*sin(x)
```

Convert the functions that have a dependency on the variable `t` using 'symfunDependingOn'.

```
X = mapSymType(expr, 'symfunDependingOn', x, func)
X = z + 2*g(t) + z*sin(x)
```

Remove Variable Dependency of Symbolic Functions

Remove variable dependency of unassigned symbolic functions in a symbolic array.

Create a symbolic array consisting of multiple equations.

```
syms f1(t) f2(t) g1(t) g2(t)
eq = [f1(t) + f2(t) == 0, f1(t) == 2*g1(t), g1(t) == diff(g2(t))]
eq =
```

$$\left(f_1(t) + f_2(t) = 0 \quad f_1(t) = 2 g_1(t) \quad g_1(t) = \frac{\partial}{\partial t} g_2(t) \right)$$

Apply the `symFunType` function to replace an unassigned symbolic function with a variable of the same name.

Find all functions that have a dependency on the variable `t` using `'symfunOf'` and convert them using `symFunType`.

```
X = mapSymType(eq, 'symfunOf', t, @symFunType)
```

```
X = (f1 + f2 = 0 f1 = 2 g1 g1 = 0)
```

Input Arguments

symObj — Symbolic objects

symbolic expressions | symbolic functions | symbolic variables | symbolic numbers | symbolic units

Symbolic objects, specified as symbolic expressions, symbolic functions, symbolic variables, symbolic numbers, or symbolic units.

type — Symbolic types

scalar string | character vector

Symbolic types, specified as a case-sensitive scalar string or character vector. The input `type` can contain a logical expression. The value options follow.

Symbolic Type Category	String Values
numbers	<ul style="list-style-type: none"> 'integer' — integer numbers 'rational' — rational numbers 'vporeal' — variable-precision floating-point real numbers 'complex' — complex numbers 'real' — real numbers, including 'integer', 'rational', and 'vporeal' 'number' — numbers, including 'integer', 'rational', 'vporeal', 'complex', and 'real'
constants	'constant' — symbolic constants, including 'number'
symbolic math functions	'vpa', 'sin', 'exp', and so on — symbolic math functions in symbolic expressions
unassigned symbolic functions	<ul style="list-style-type: none"> 'F', 'g', and so on — function name of an unassigned symbolic function 'symfun' — unassigned symbolic functions
arithmetic operators	<ul style="list-style-type: none"> 'plus' — addition operator + and subtraction operator - 'times' — multiplication operator * and division operator / 'power' — power or exponentiation operator ^ and square root operator sqrt

Symbolic Type Category	String Values
variables	'variable' — symbolic variables
units	'units' — symbolic units
expressions	'expression' — symbolic expressions, including all of the preceding symbolic types
logical expressions	<ul style="list-style-type: none"> 'or' — logical OR operator 'and' — logical AND operator & 'not' — logical NOT operator ~ 'xor' — logical exclusive-OR operator xor 'logicalexpression' — logical expressions, including 'or', 'and', 'not', and 'xor'
equations and inequalities	<ul style="list-style-type: none"> 'eq' — equality operator == 'ne' — inequality operator ~= 'lt' — less-than operator < or greater-than operator > 'le' — less-than-or-equal-to operator <= or greater-than-or-equal-to operator >= 'equation' — symbolic equations and inequalities, including 'eq', 'ne', 'lt', and 'le'
unsupported symbolic types	'unsupported' — unsupported symbolic types

func — Input function

function handle | symbolic function

Input function, specified as a function handle or symbolic function. For more information about function handles and symbolic function, see “Create Function Handle” (MATLAB) and `symfun`, respectively.

If `symObj` contains several subexpressions of type `type`, then `mapSymType` applies the function `func` to the largest subexpression (topmost matching node in a tree data structure).

funType — Function type

'symfunOf' | 'symfunDependingOn'

Function type, specified as 'symfunOf' or 'symfunDependingOn'.

- 'symfunOf' applies `func` to the unassigned symbolic functions that depend on the exact sequence of variables specified by the array `vars`. For example, `syms f(x,y); mapSymType(f,'symfunOf',[x y],@(g)g^2)` returns $f(x,y)^2$.
- 'symfunDependingOn' applies `func` to the unassigned symbolic functions that have a dependency on the variables specified by the array `vars`. For example, `syms f(x,y); mapSymType(f,'symfunDependingOn',x, @(g)g/2)` returns $f(x,y)/2$.

vars — Input variables

symbolic variables | symbolic array

Input variables, specified as symbolic variables or a symbolic array.

See Also

findSymType | hasSymType | isSymType | str2sym | sym | symFunType | symType | symfun | syms

Introduced in R2019a

massMatrixForm

Extract mass matrix and right side of semilinear system of differential algebraic equations

Syntax

```
[M,F] = massMatrixForm(eqs,vars)
```

Description

`[M,F] = massMatrixForm(eqs,vars)` returns the mass matrix M and the right side of equations F of a semilinear system of first-order differential algebraic equations (DAEs). Algebraic equations in `eqs` that do not contain any derivatives of the variables in `vars` correspond to empty rows of the mass matrix M .

The mass matrix M and the right side of equations F refer to this form.

$$M(t, x(t))\dot{x}(t) = F(t, x(t)).$$

Examples

Convert DAE System to Mass Matrix Form

Convert a semilinear system of differential algebraic equations to mass matrix form.

Create the following system of differential algebraic equations. Here, the functions $x_1(t)$ and $x_2(t)$ represent state variables of the system. The system also contains symbolic parameters r and m , and the function $f(t, x_1, x_2)$. Specify the equations and variables as two symbolic vectors: equations as a vector of symbolic equations, and variables as a vector of symbolic function calls.

```
syms x1(t) x2(t) f(t, x1, x2) r m;
eqs = [m*x2(t)*diff(x1(t), t) + m*t*diff(x2(t), t) == f(t,x1(t),x2(t)),...
      x1(t)^2 + x2(t)^2 == r^2];
vars = [x1(t) x2(t)];
```

Find the mass matrix form of this system.

```
[M,F] = massMatrixForm(eqs, vars)
```

```
M =
[ m*x2(t), m*t]
[          0,  0]
```

```
F =
      f(t, x1(t), x2(t))
r^2 - x2(t)^2 - x1(t)^2
```

Solve this system using the numerical solver `ode15s`. Before you use `ode15s`, assign the following values to symbolic parameters of the system: $m = 100$, $r = 1$, $f(t, x_1, x_2) = t + x_1*x_2$. Also, replace the state variables $x_1(t)$, $x_2(t)$ by variables $Y1$, $Y2$ acceptable by `matlabFunction`.

```
syms Y1 Y2;
M = subs(M, [vars,m,r,f], [Y1,Y2,100,1,@(t,x1,x2) t+x1*x2]);
F = subs(F, [vars,m,r,f], [Y1,Y2,100,1,@(t,x1,x2) t+x1*x2]);
```

Create the following function handles MM and FF. You can use these function handles as input arguments for `odeset` and `ode15s`. These functions require state variables to be specified as column vectors.

```
MM = matlabFunction(M,'vars',{t,[Y1;Y2]});
FF = matlabFunction(F,'vars',{t,[Y1;Y2]});
```

Solve the system using `ode15s`.

```
opt = odeset('Mass', MM, 'InitialSlope', [0.005;0]);
ode15s(FF, [0,1], [0.5; 0.5*sqrt(3)], opt)
```

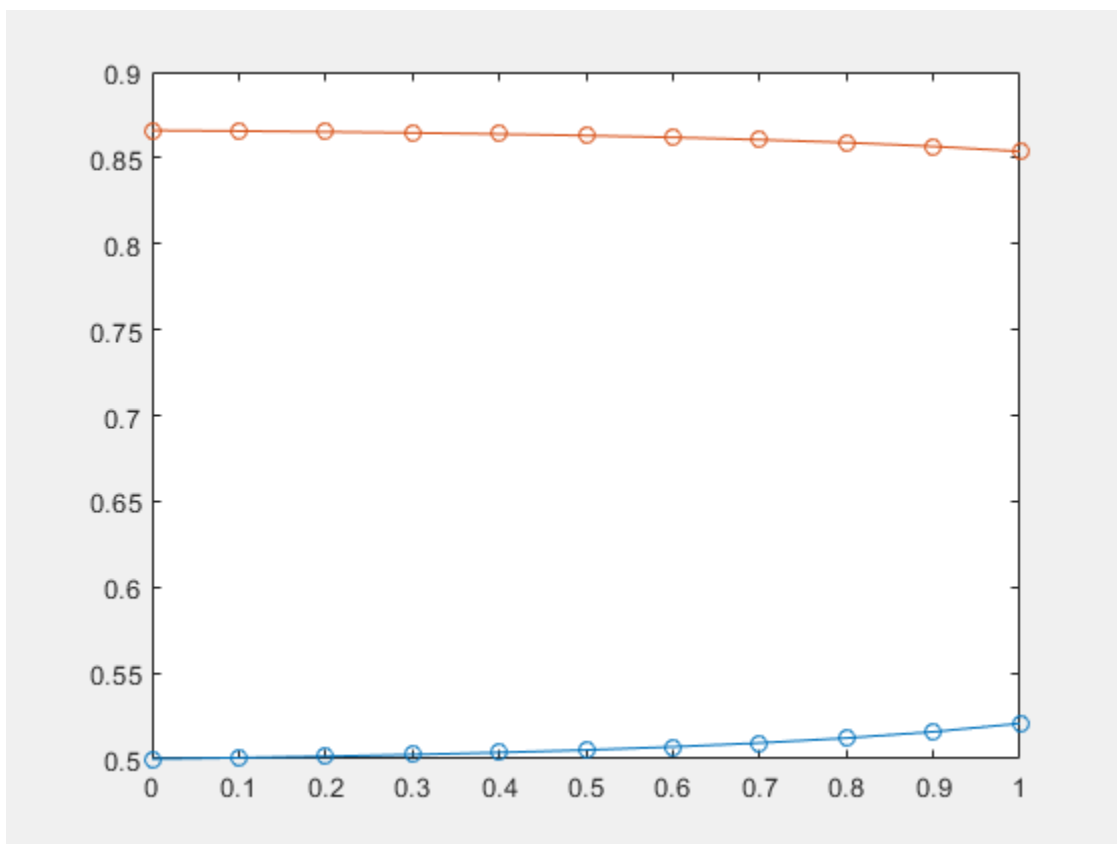

Input Arguments

eqs — System of semilinear first-order DAEs

vector of symbolic equations | vector of symbolic expressions

System of semilinear first-order DAEs, specified as a vector of symbolic equations or expressions.

vars — State variables

vector of symbolic functions | vector of symbolic function calls

State variables, specified as a vector of symbolic functions or function calls, such as $x(t)$.

Example: $[x(t), y(t)]$ or $[x(t); y(t)]$

Output Arguments

M — Mass matrix

symbolic matrix

Mass matrix of the system, returned as a symbolic matrix. The number of rows is the number of equations in `eqs`, and the number of columns is the number of variables in `vars`.

F — Right sides of equations

symbolic column vector of symbolic expressions

Right sides of equations, returned as a column vector of symbolic expressions. The number of elements in this vector is equal to the number of equations in `eqs`.

See Also

`daeFunction` | `decic` | `findDecoupledBlocks` | `incidenceMatrix` | `isLowIndexDAE` | `matlabFunction` | `ode15s` | `odeFunction` | `odeset` | `reduceDAEIndex` | `reduceDAEToODE` | `reduceDifferentialOrder` | `reduceRedundancies`

Topics

“Solve DAEs Using Mass Matrix Solvers” on page 2-209

Introduced in R2014b

mathml

Generate MathML from symbolic expression

Syntax

```
chr = mathml(f)
chr = mathml(f,Name,Value)
```

Description

`chr = mathml(f)` returns the generated MathML from the symbolic expression `f`.

`chr = mathml(f,Name,Value)` uses additional options specified by one or more name-value pair arguments. For example, generate MathML for inline display by specifying `DisplayInline` as `true`.

Examples

MathML from Symbolic Expression

Generate MathML from a symbolic expression.

```
syms x
f = 1/exp(x^2);
chr = mathml(f)

chr =
'<math xmlns='http://www.w3.org/1998/Math/MathML' display='block'>
  <msup>
    <mo>&ee;</mo>
    <mrow>
      <mo>-</mo>
      <msup>
        <mi>x</mi>
        <mn>2</mn>
      </msup>
    </mrow>
  </msup>
</math>
'
```

Inline Display of MathML

Generate MathML for inline display by specifying `DisplayInline` as `true`.

```
syms x
f = 1/exp(x^2);
chr = mathml(f,'DisplayInline',true)

chr =
'<math xmlns='http://www.w3.org/1998/Math/MathML'>
```

```

<msup>
  <mo>&ee;</mo>
  <mrow>
    <mo>-</mo>
    <msup>
      <mi>x</mi>
      <mn>2</mn>
    </msup>
  </mrow>
</msup>
</math>

```

Add Tooltips for Symbols to Generated MathML

Use MathML tooltips for units and some special functions to provide more information. Generate tooltips by specifying `Tooltips` as `true`.

```

syms nu x
f = besselj(nu,x);
chr = mathml(f,'Tooltips',true)

chr =
'<math xmlns='http://www.w3.org/1998/Math/MathML' display='block'>
  <mrow>
    <msub>
      <maction actiontype='tooltip'>
        <mo>J</mo>
        <mtext>besselj</mtext>
      </maction>
      <mi>&nu;</mi>
    </msub>
    <mrow>
      <mo form='prefix'>( </mo>
      <mi>x</mi>
      <mo form='postfix'>)</mo>
    </mrow>
  </mrow>
</math>

```

When you use MathML in a web page, then pausing on J displays a tooltip containing *besselj*.

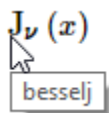

Modify Generated MathML with Symbolic Preferences

Modify generated MathML by setting symbolic preferences using the `sympref` function.

Generate the MathML form of the expression π with the default symbolic preference.

```

sympref('default');
chr = mathml(sym(pi))

```

```
chr =
    '<math xmlns='http://www.w3.org/1998/Math/MathML' display='block'>
        <mi>&pi;</mi>
    </math>'

```

Set the 'FloatingPointOutput' preference to true to return symbolic output in floating-point format. Generate the MathML form of π in floating-point format.

```
sympref('FloatingPointOutput',true);
chr = mathml(sym(pi))

chr =
    '<math xmlns='http://www.w3.org/1998/Math/MathML' display='block'>
        <mn>3.1416</mn>
    </math>'

```

Now change the output order of a symbolic polynomial. Create a symbolic polynomial and set 'PolynomialDisplayStyle' preference to 'ascend'. Generate MathML form of the polynomial sorted in ascending order.

```
syms x;
poly = x^2 - 2*x + 1;
sympref('PolynomialDisplayStyle','ascend');
chr = mathml(poly)

chr =
    '<math xmlns='http://www.w3.org/1998/Math/MathML' display='block'>
        <mrow>
            <mn>1</mn>
            <mo>-</mo>
            <mrow>
                <mn>2</mn>
                <mo form='infix'>&InvisibleTimes;</mo>
                <mi>x</mi>
            </mrow>
            <mo>+</mo>
            <msup>
                <mi>x</mi>
                <mn>2</mn>
            </msup>
        </mrow>
    </math>'

```

The preferences you set using `sympref` persist through your current and future MATLAB sessions. Restore the default values by specifying the 'default' option.

```
sympref('default');
```

Input Arguments

f — Input

symbolic number | symbolic variable | symbolic array | symbolic function | symbolic expression

Input, specified as a symbolic number, variable, array, function, or expression.

Name-Value Pair Arguments

Specify optional comma-separated pairs of `Name`, `Value` arguments. `Name` is the argument name and `Value` is the corresponding value. `Name` must appear inside quotes. You can specify several name and value pair arguments in any order as `Name1, Value1, ..., NameN, ValueN`.

Example: `mathml(f, 'Tooltips', true)`

DisplayInline — Inline MathML display

`false` (default) | `true`

Inline MathML display, specified as the comma-separated pair consisting of `'DisplayInline'` and either `true` or `false` (default).

Tooltips — tooltips

`false` (default) | `true`

Tooltips in MathML output, specified as the comma-separated pair consisting of `'Tooltips'` and either `true` or `false` (default). `mathml` adds tooltips for units and some special functions.

See Also

`ccode` | `fortran` | `latex` | `sympref` | `texlabel`

Introduced in R2018b

matlabFunction

Convert symbolic expression to function handle or file

Syntax

```
g = matlabFunction(f)
g = matlabFunction(f1,...,fN)
g = matlabFunction( ___,Name,Value)
```

Description

`g = matlabFunction(f)` converts the symbolic expression or function `f` to a MATLAB function with handle `g`. The converted function can be used without Symbolic Math Toolbox.

`g = matlabFunction(f1,...,fN)` converts `f1,...,fN` to a MATLAB function with `N` outputs. The function handle is `g`. Each element of `f1,...,fN` can be a symbolic expression, function, or a vector of symbolic expressions or functions.

`g = matlabFunction(___,Name,Value)` uses additional options specified by one or more `Name,Value` pair arguments. You can specify `Name,Value` after the input arguments used in the previous syntaxes.

Examples

Convert Symbolic Expression to Anonymous Function

Convert the symbolic expression `r` to a MATLAB function with the handle `ht`. The converted function can be used without Symbolic Math Toolbox.

```
syms x y
r = sqrt(x^2 + y^2);
ht = matlabFunction(r)

ht =
function_handle with value:
 @(x,y)sqrt(x.^2+y.^2)
```

Convert multiple symbolic expressions using comma-separated input.

```
ht = matlabFunction(r, r^2)

ht =
function_handle with value:
 @(x,y)deal(sqrt(x.^2+y.^2),x.^2+y.^2)
```

Convert Symbolic Function to Anonymous Function

Create a symbolic function and convert it to a MATLAB function with the handle `ht`.

```
syms x y
f(x,y) = x^3 + y^3;
ht = matlabFunction(f)

ht =
    function_handle with value:
        @(x,y)x.^3+y.^3
```

Write MATLAB Function to File with Comments

Write the generated MATLAB function to a file by specifying the `File` option. Existing files are overwritten. When writing to a file, `matlabFunction` optimizes the code using intermediate variables named `t0`, `t1`, Include comments in the file by using the `Comments` option.

Write the MATLAB function generated from `f` to the file `myfile`.

```
syms x
f = x^2 + log(x^2);
matlabFunction(f,'File','myfile');

function f = myfile(x)
%MYFILE
%    F = MYFILE(X)

%    This function was generated by the Symbolic Math Toolbox version 8.4.
%    01-Sep-2019 00:00:00

t2 = x.^2;
f = t2+log(t2);
```

Include the comment `Version: 1.1` in the file.

```
matlabFunction(f,'File','myfile','Comments','Version: 1.1')

function f = myfile(x)
...
%Version: 1.1
t2 = x.^2;
...
```

Disable Code Optimization

When you convert a symbolic expression to a MATLAB function and write the resulting function to a file, `matlabFunction` optimizes the code by default. This approach can help simplify and speed up further computations that use the file. However, generating the optimized code from some symbolic expressions and functions can be time-consuming. Use `Optimize` to disable code optimization.

Create a symbolic expression.

```
syms x
r = x^2*(x^2 + 1);
```

Convert `r` to a MATLAB function and write the function to the file `myfile`. By default, `matlabFunction` creates a file containing the optimized code.

```
f = matlabFunction(r,'File','myfile');
```

```
function r = myfile(x)
%MYFILE
%    R = MYFILE(X)
t2 = x.^2;
r = t2.*(t2+1.0);
```

Disable the code optimization by setting the value of `Optimize` to `false`.

```
f = matlabFunction(r,'File','myfile','Optimize',false);
```

```
function r = myfile(x)
%MYFILE
%    R = MYFILE(X)
r = x.^2.*(x.^2+1.0);
```

Generate Sparse Matrices

When you convert a symbolic matrix to a MATLAB function, `matlabFunction` represents it by a dense matrix by default. If most of the elements of the input symbolic matrix are zeros, the more efficient approach is to represent it by a sparse matrix.

Create a 3-by-3 symbolic diagonal matrix.

```
syms x
A = diag(x*ones(1,3))
```

```
A =
[ x, 0, 0]
[ 0, x, 0]
[ 0, 0, x]
```

Convert `A` to a MATLAB function representing a numeric matrix, and write the result to the file `myfile1`. By default, the generated MATLAB function creates the dense numeric matrix specifying each element of the matrix, including all zero elements.

```
f1 = matlabFunction(A,'File','myfile1');
```

```
function A = myfile1(x)
%MYFILE1
%    A = MYFILE1(X)
A = reshape([x,0.0,0.0,0.0,x,0.0,0.0,0.0,x],[3,3]);
```

Convert `A` to a MATLAB function by setting `Sparse` to `true`. Now, the generated MATLAB function creates the sparse numeric matrix specifying only nonzero elements and assuming that all other elements are zeros.

```
f2 = matlabFunction(A,'File','myfile2','Sparse',true);
```

```
function A = myfile2(x)
%MYFILE2
%    A = MYFILE2(X)
A = sparse([1,2,3],[1,2,3],[x,x,x],3,3);
```

Specify Input Arguments for Generated Function

When converting an expression to a MATLAB function, you can specify the order of the input arguments of the resulting function. You can also specify that some input arguments are vectors instead of single variables.

Create a symbolic expression.

```
syms x y z
r = x + y/2 + z/3;
```

Convert r to a MATLAB function and write this function to the file `myfile`. By default, `matlabFunction` uses alphabetical order of input arguments when converting symbolic expressions.

```
matlabFunction(r,'File','myfile');
```

```
function r = myfile(x,y,z)
%MYFILE
%   R = MYFILE(X,Y,Z)
r = x+y./2.0+z./3.0;
```

Use the `Vars` argument to specify the order of input arguments for the generated MATLAB function.

```
matlabFunction(r,'File','myfile','Vars',[y z x]);
```

```
function r = myfile(y,z,x)
%MYFILE
%   R = MYFILE(Y,Z,X)
r = x+y./2.0+z./3.0;
```

Now, convert an expression r to a MATLAB function whose second input argument is a vector.

```
syms x y z t
r = (x + y/2 + z/3)*exp(-t);
matlabFunction(r,'File','myfile','Vars',{t,[x y z]});
```

```
function r = myfile(t,in2)
%MYFILE
%   R = MYFILE(T,IN2)
x = in2(:,1);
y = in2(:,2);
z = in2(:,3);
r = exp(-t).*(x+y./2.0+z./3.0);
```

Specify Output Variables

When converting a symbolic expression to a MATLAB function, you can specify the names of the output variables. Note that `matlabFunction` without the `File` argument (or with a file path specified by an empty character vector) creates a function handle and ignores the `Outputs` flag.

Create symbolic expressions r and q .

```
syms x y z
r = x^2 + y^2 + z^2;
q = x^2 - y^2 - z^2;
```

Convert r and q to a MATLAB function and write the resulting function to a file `myfile`, which returns a vector of two elements, `name1` and `name2`.

```
f = matlabFunction(r,q,'File','myfile',...
    'Outputs',{'name1','name2'});

function [name1,name2] = myfile(x,y,z)
%MYFILE
%    [NAME1,NAME2] = MYFILE(X,Y,Z)
t2 = x.^2;
t3 = y.^2;
t4 = z.^2;
name1 = t2+t3+t4;
if nargout > 1
    name2 = t2-t3-t4;
end
```

Input Arguments

f — Symbolic input to be converted to MATLAB function

symbolic expression | symbolic function | symbolic vector | symbolic matrix

Symbolic input to be converted to a MATLAB function, specified as a symbolic expression, function, vector, or matrix. When converting sparse symbolic vectors or matrices, use the name-value pair argument `'Sparse', true`.

f1, ..., fN — Symbolic input to be converted to MATLAB function with N outputs

several symbolic expressions | several symbolic functions | several symbolic vectors | several symbolic matrices

Symbolic input to be converted to MATLAB function with N outputs, specified as several symbolic expressions, functions, vectors, or matrices, separated by comma.

`matlabFunction` does not create a separate output argument for each element of a symbolic vector or matrix. For example, `g = matlabFunction([x + 1, y + 1])` creates a MATLAB function with one output argument, while `g = matlabFunction(x + 1, y + 1)` creates a MATLAB function with two output arguments.

Name-Value Pair Arguments

Specify optional comma-separated pairs of `Name, Value` arguments. `Name` is the argument name and `Value` is the corresponding value. `Name` must appear inside quotes. You can specify several name and value pair arguments in any order as `Name1, Value1, ..., NameN, ValueN`.

Example: `matlabFunction(f,'File','myfile','Optimize',false)`

Comments — Comments to include in file header

character vector | cell array of character vectors | string vector

Comments to include in the file header, specified as a character vector, cell array of character vectors, or string vector.

File — Path to file containing generated MATLAB function

character vector

Path to the file containing the generated MATLAB function, specified as a character vector. The generated function accepts arguments of type `double`, and can be used without Symbolic Math

Toolbox. If `File` is empty, `matlabFunction` generates an anonymous function. If `File` does not end in `.m`, the function appends `.m`.

When writing to a file, `matlabFunction` optimizes the code using intermediate variables named `t0`, `t1`, To disable code optimization, use the `Optimize` argument.

See “Write MATLAB Function to File with Comments” on page 4-940.

Optimize — Flag preventing optimization of code written to function file

`true` (default) | `false`

Flag preventing optimization of code written to a function file, specified as `false` or `true`.

When writing to a file, `ccode` optimizes the code using intermediate variables named `t0`, `t1`,

`matlabFunction` without the `File` argument (or with a file path specified by an empty character vector) creates a function handle. In this case, the code is not optimized. If you try to enforce code optimization by setting `Optimize` to `true`, then `matlabFunction` throws an error.

See “Disable Code Optimization” on page 4-940.

Sparse — Flag that switches between sparse and dense matrix generation

`false` (default) | `true`

Flag that switches between sparse and dense matrix generation, specified as `true` or `false`. When you specify `'Sparse'`, `true`, the generated MATLAB function represents symbolic matrices by sparse numeric matrices. Use `'Sparse'`, `true` when you convert symbolic matrices containing many zero elements. Often, operations on sparse matrices are more efficient than the same operations on dense matrices.

See “Generate Sparse Matrices” on page 4-941.

Vars — Order of input variables or vectors in generated MATLAB function

character vector | vector of symbolic variables | one-dimensional cell array of character vectors | one-dimensional cell array of symbolic variables | one-dimensional cell array of vectors of symbolic variables

Order of input variables or vectors in a generated MATLAB function, specified as a character vector, a vector of symbolic variables, or a one-dimensional cell array of character vectors, symbolic variables, or vectors of symbolic variables.

The number of specified input variables must equal or exceed the number of free variables in `f`. Do not use the same names for the input variables specified by `Vars` and the output variables specified by `Outputs`.

By default, when you convert symbolic expressions, the order is alphabetical. When you convert symbolic functions, their input arguments appear in front of other variables, and all other variables are sorted alphabetically.

See “Specify Input Arguments for Generated Function” on page 4-941.

Outputs — Names of output variables

one-dimensional cell array of character vectors

Names of output variables, specified as a one-dimensional cell array of character vectors.

If you do not specify the output variable names, then they coincide with the names you use when calling `matlabFunction`. If you call `matlabFunction` using an expression instead of individual variables, the default names of output variables consist of the word `out` followed by a number, for example, `out3`.

Do not use the same names for the input variables specified by `Vars` and the output variables specified by `Outputs`.

`matlabFunction` without the `File` argument (or with a file path specified by an empty character vector) creates a function handle. In this case, `matlabFunction` ignores the `Outputs` flag.

See “Specify Output Variables” on page 4-942.

Output Arguments

g – Function handle that can serve as input argument to numerical functions

MATLAB function handle

Function handle that can serve as an input argument to numerical functions, returned as a MATLAB function handle.

Tips

- When you use the `File` argument, use `rehash` to make the generated function available immediately. `rehash` updates the MATLAB list of known files for directories on the search path.
- If the `File` option is empty, then an anonymous function is returned.

See Also

`ccode` | `daeFunction` | `fortran` | `matlabFunctionBlock` | `odeFunction` | `rehash` | `simscapeEquation` | `subs` | `sym2poly`

Topics

“Generate MATLAB Functions from Symbolic Expressions” on page 2-267

Introduced in R2008b

matlabFunctionBlock

Convert symbolic expression to MATLAB function block

Syntax

```
matlabFunctionBlock(block,f)
matlabFunctionBlock(block,f1,...,fN)
matlabFunctionBlock(____,Name,Value)
```

Description

`matlabFunctionBlock(block,f)` converts `f` to a MATLAB function block that you can use in Simulink models. Here, `f` can be a symbolic expression, function, or a vector of symbolic expressions or functions.

`block` specifies the name of the block that you create or modify.

`matlabFunctionBlock(block,f1,...,fN)` converts symbolic expressions or functions `f1,...,fN` to a MATLAB function block with `N` outputs. Each element of `f1,...,fN` can be a symbolic expression, function, or a vector of symbolic expressions or functions.

`matlabFunctionBlock(____,Name,Value)` converts a symbolic expression, function, or a vector of symbolic expressions or functions to a MATLAB function block using additional options specified by one or more `Name,Value` pair arguments. You can specify `Name,Value` after the input arguments used in the previous syntaxes.

Examples

Convert Symbolic Expression to MATLAB Function Block

Create a new model and convert a symbolic expression to a MATLAB function block. Include comments in the block by specifying the `Comments` option.

Create a new model and open it.

```
new_system('my_system')
open_system('my_system')
```

Create a symbolic expression.

```
syms x y z
f = x^2 + y^2 + z^2;
```

Use `matlabFunctionBlock` to create the block `my_block` containing the symbolic expression. `matlabFunctionBlock` overwrites existing blocks. Double-click the generated block to open and edit the function defining the block.

```
matlabFunctionBlock('my_system/my_block',f)

function f = my_block(x,y,z)
%#codegen
```



```
% This function was generated by the Symbolic Math Toolbox version 7.3.
% 01-Jan-2017 00:00:00
```

```
f = x.^2+y.^2+z.^2;
```

Include the comment **Version 1.1** in the block.

```
matlabFunctionBlock('my_system/my_block',f,'Comments','Version: 1.1')
```

```
function f = my_block(x,y,z)
```

```
...
```

```
%Version: 1.1
```

```
f = x.^2+y.^2+z.^2;
```

Save and close my_system.

```
save_system('my_system')
close_system('my_system')
```

Convert Symbolic Function MATLAB Function Block

Create a new model and convert a symbolic function to a MATLAB function block.

Create a new empty model and open it.

```
new_system('my_system')
open_system('my_system')
```

Create a symbolic function.

```
syms x y z
f(x, y, z) = x^2 + y^2 + z^2;
```

Convert f to a MATLAB function block. Double-click the block to see the function.

```
matlabFunctionBlock('my_system/my_block',f)
```

```
function f = my_block(x,y,z)
```

```
 %#codegen
```

```
f = x.^2+y.^2+z.^2;
```

Create Blocks with Multiple Outputs

Convert several symbolic expressions to a MATLAB function block with multiple output ports.

Create a new empty model and open it.

```
new_system('my_system')
open_system('my_system')
```

Create three symbolic expressions.

```
syms x y z
f = x^2;
```

```
g = y^2;  
h = z^2;
```

Convert them to a MATLAB function block. `matlabFunctionBlock` creates a block with three output ports. Double-click the block to see the function.

```
matlabFunctionBlock('my_system/my_block',f,g,h)  
  
function [f,g,h] = my_block(x,y,z)  
%#codegen  
f = x.^2;  
if nargin > 1  
    g = y.^2;  
end  
if nargin > 2  
    h = z.^2;  
end
```

Specify Function Name for Generated Function

Specifying the name of the function defining the generated MATLAB function block.

Create a new empty model and open it.

```
new_system('my_system')  
open_system('my_system')
```

Create a symbolic expression.

```
syms x y z  
f = x^2 + y^2 + z^2;
```

Generate a block and set the function name to `my_function`. Double-click the block to see the function.

```
matlabFunctionBlock('my_system/my_block',f,...  
                    'FunctionName', 'my_function')  
  
function f = my_function(x,y,z)  
%#codegen  
f = x.^2+y.^2+z.^2;
```

Disable Code Optimization

When you convert a symbolic expression to a MATLAB function block, `matlabFunctionBlock` optimizes the code by default. This approach can help simplify and speed up further computations that use the file. Nevertheless, generating the optimized code from some symbolic expressions and functions can be very time-consuming. Use `Optimize` to disable code optimization.

Create a new empty model and open it.

```
new_system('my_system')  
open_system('my_system')
```

Create a symbolic expression.

```
syms x
r = x^2*(x^2 + 1);
```

Use `matlabFunctionBlock` to create the block `my_block` containing the symbolic expression. Double-click the block to see the function defining the block. By default, `matlabFunctionBlock` creates a file containing the optimized code.

```
matlabFunctionBlock('my_system/my_block', r)

function r = my_block(x)
%#codegen
t2 = x.^2;
r = t2.*(t2+1.0);
```

Disable the code optimization by setting the value of `Optimize` to `false`.

```
matlabFunctionBlock('my_system/my_block', r, ...
                    'Optimize', false)

function r = my_block(x)
%#codegen
r = x.^2.*(x.^2+1.0);
```

Specify Input Ports for Generated Block

Specify the order of the input variables that form the input ports in a generated block.

Create a new empty model and open it.

```
new_system('my_system')
open_system('my_system')
```

Create a symbolic expression.

```
syms x y z
f = x^2 + y^2 + z^2;
```

Convert the expression to a MATLAB function block. By default, `matlabFunctionBlock` uses alphabetical order of input arguments when converting symbolic expressions.

```
matlabFunctionBlock('my_system/my_block', f)

function f = my_block(x,y,z)
%#codegen
f = x.^2+y.^2+z.^2;
```

Use the `Vars` argument to specify the order of the input ports.

```
matlabFunctionBlock('my_system/my_block', f, ...
                    'Vars', [y z x])

function f = my_block(y,z,x)
%#codegen
f = x.^2+y.^2+z.^2;
```

Specify Output Ports

When generating a block, rename the output variables and the corresponding ports.

Create a new empty model and open it.

```
new_system('my_system')
open_system('my_system')
```

Create a symbolic expression.

```
syms x y z
f = x^2 + y^2 + z^2;
```

Convert the expression to a MATLAB function block and specify the names of the output variables and ports. Double-click the block to see the function defining the block.

```
matlabFunctionBlock('my_system/my_block',f,f + 1,f + 2,...
    'Outputs', {'name1','name2','name3'})
```

```
function [name1,name2,name3] = my_block(x,y,z)
%#codegen
t2 = x.^2;
t3 = y.^2;
t4 = z.^2;
name1 = t2+t3+t4;
if nargin > 1
    name2 = t2+t3+t4+1.0;
end
if nargin > 2
    name3 = t2+t3+t4+2.0;
end
```

Specify Function Name, Input and Output Ports

Call `matlabFunctionBlock` using several name-value pair arguments simultaneously.

Create a new empty model and open it.

```
new_system('my_system')
open_system('my_system')
```

Create a symbolic expression.

```
syms x y z
f = x^2 + y^2 + z^2;
```

Call `matlabFunctionBlock` using the name-value pair arguments to specify the function name, the order of the input ports, and the names of the output ports. Double-click the block to see the function defining the block.

```
matlabFunctionBlock('my_system/my_block',f,f + 1,f + 2,...
    'FunctionName', 'my_function','Vars',[y z x],...
    'Outputs',{'name1','name2','name3'})
```

```
function [name1,name2,name3] = my_function(y,z,x)
%#codegen
```

```

t2 = x.^2;
t3 = y.^2;
t4 = z.^2;
name1 = t2+t3+t4;
if nargin > 1
    name2 = t2+t3+t4+1.0;
end
if nargin > 2
    name3 = t2+t3+t4+2.0;
end

```

Input Arguments

block — Block to create or modify

character vector

Block to create or modify, specified as a character vector.

f — Symbolic input to be converted to MATLAB function block

symbolic expression | symbolic function | symbolic vector | symbolic matrix

Symbolic input to be converted to MATLAB function block, specified as a symbolic expression, function, vector, or matrix

f1, ..., fN — Symbolic input to be converted to MATLAB function block with N outputs

several symbolic expressions | several symbolic functions | several symbolic vectors | several symbolic matrices

Symbolic input to be converted to MATLAB function block with N outputs, specified as several symbolic expressions, functions, vectors, or matrices, separated by comma.

Name-Value Pair Arguments

Specify optional comma-separated pairs of `Name`, `Value` arguments. `Name` is the argument name and `Value` is the corresponding value. `Name` must appear inside quotes. You can specify several name and value pair arguments in any order as `Name1, Value1, ..., NameN, ValueN`.

Example: `matlabFunctionBlock('my_system/my_block', f, 'FunctionName', 'myfun')`

Comments — Comments to include in file header

character vector | cell array of character vectors | string vector

Comments to include in the file header, specified as a character vector, cell array of character vectors, or string vector.

FunctionName — Name of function

coincides with the input argument `block` (default) | character vector

Name of the function, specified as a character vector. By default, `matlabFunction(block, ...)` uses `block` as the function name.

See “Specify Function Name for Generated Function” on page 4-948.

Optimize — Flag preventing code optimization

true (default) | false

Flag preventing code optimization, specified as `false` or `true`.

When writing to a file, `matlabFunctionBlock` optimizes the code using intermediate variables named `t0`, `t1`, ...

See “Disable Code Optimization” on page 4-948.

Vars — Order of input variables and corresponding input ports of generated block

character vector | one-dimensional cell array of character vectors | one-dimensional cell array of symbolic variables | one-dimensional cell array of vectors of symbolic variables | vector of symbolic variables

Order of input variables and corresponding input ports of generated block, specified as a character vector, a vector of symbolic variables, or a one-dimensional cell array of character vectors, symbolic variables, or vectors of symbolic variables.

The number of specified input ports must equal or exceed the number of free variables in `f`. Do not use the same names for the input ports specified by `Vars` and the output ports specified by `Outputs`.

By default, when you convert symbolic expressions, the order is alphabetical. When you convert symbolic functions, their input arguments appear in front of other variables, and all other variables are sorted alphabetically.

See “Specify Input Ports for Generated Block” on page 4-949.

Outputs — Names of output ports

`out` followed by output port numbers (default) | one-dimensional cell array of character vectors

Names of output ports, specified as a one-dimensional cell array of character vectors. If you do not specify the output port names, `matlabFunctionBlock` uses names that consist of the word `out` followed by output port numbers, for example, `out3`.

Do not use the same names for the input ports specified by `Vars` and the output ports specified by `Outputs`. See “Specify Output Ports” on page 4-949.

See Also

`ccode` | `fortran` | `matlabFunction` | `simscapeEquation` | `subs` | `sym2poly`

Topics

“Generate MATLAB Function Blocks from Symbolic Expressions” on page 2-270

Introduced in R2009a

meijerG

Meijer G-function

Syntax

`meijerG(a,b,c,d,z)`

Description

`meijerG(a,b,c,d,z)` returns the “Meijer G-Function” on page 4-957. `meijerG` is element-wise in `z`. The input parameters `a`, `b`, `c`, and `d` are vectors that can be empty, as in `meijerG([], [], 3.2, [], 1)`.

Examples

Calculate Meijer G-Function for Numeric Inputs

```
syms x
meijerG(3, [], [], 2, 5)
```

```
ans =
    25
```

Call `meijerG` when `z` is an array. `meijerG` acts element-wise.

```
a = 2;
z = [1 2 3];
meijerG(a, [], [], [], z)
```

```
ans =
    0.3679    1.2131    2.1496
```

Calculate Meijer G-Function for Symbolic Numbers

Convert numeric input to symbolic form using `sym`, and find the Meijer G-function. For certain symbolic inputs, `meijerG` returns exact symbolic output using other functions.

```
meijerG(sym(2), [], [], [], sym(3))
```

```
ans =
3*exp(-1/3)
```

```
meijerG(sym(2/5), [], sym(1/2), [], sym(3))
```

```
ans =
(2^(4/5)*3^(1/2)*gamma(1/10))/80
```

Find Meijer G-Function for Symbolic Variables or Expressions

For symbolic variables or expressions, `meijerG` returns an output in terms of simple or special functions.

```
syms a b c d z
f = meijerG(a,b,c,d,z)

f =
(gamma(c - a + 1)*(1/z)^(1 - a)*hypergeom([c - a + 1, d - a + 1],...
  b - a + 1, 1/z))/(gamma(b - a + 1)*gamma(a - d))
```

Substitute values for the variables by using `subs`, and convert values to double by using `double`.

```
fVal = subs(f, [a b c d z], [1.2 3 5 7 9])

fVal =
(266*9^(1/5)*hypergeom([24/5, 34/5], 14/5, 1/9))/(25*gamma(-29/5))

double(fVal)

ans =
  5.7586e+03
```

Calculate `fVal` to higher precision using `vpa`.

```
vpa(fVal)

ans =
5758.5946416377834597597497022199
```

Differentiate Meijer G-Function

Differentiate the Meijer G-function by using `diff`.

```
syms a b c d z
mG = meijerG(a, b, c, d, z);
diffmG = diff(mG)

diffmG =
(gamma(c - a + 1)*(a - 1)*hypergeom([c - a + 1, d - a + 1],...
  b - a + 1, 1/z))/(z^2*gamma(b - a + 1)*gamma(a - d)*(1/z)^a)...
- (gamma(c - a + 1)*(1/z)^(1 - a)*(c - a + 1)*(d - a + 1)...
*hypergeom([c - a + 2, d - a + 2], b - a + 2, 1/z))...
/(z^2*gamma(b - a + 1)*gamma(a - d)*(b - a + 1))
```

Relations Between Meijer G-Function and Other Functions

Show relations between `meijerG` and simpler functions for given parameter values.

Show that when `a`, `b`, and `d` are empty, and `c = 0`, then `meijerG` reduces to $\exp(-z)$.

```
syms z
meijerG([], [], 0, [], z)

ans =
exp(-z)
```

Show that when `a`, `b`, and `d` are empty, and `c = [1/2 -1/2]`, then `meijerG` reduces to $2K_v(1, 2z^{1/2})$.

```
meijerG([], [], [1/2 -1/2], [], z)
```

```
ans =  
2*besselk(1, 2*z^(1/2))
```

Plot Meijer G-Function

Plot the real and imaginary values of the Meijer G-function for values of b and z , where $a = [-2 \ 2]$ and c and d are empty. Fill the contours by setting `Fill` to `on`.

```
syms b z  
f = meijerG([-2 2], b, [], [], z);
```

```
subplot(2,2,1)  
fcontour(real(f), 'Fill', 'on')  
title('Real Values of Meijer G')  
xlabel('b')  
ylabel('z')
```

```
subplot(2,2,2)  
fcontour(imag(f), 'Fill', 'on')  
title('Imag. Values of Meijer G')  
xlabel('b')  
ylabel('z')
```

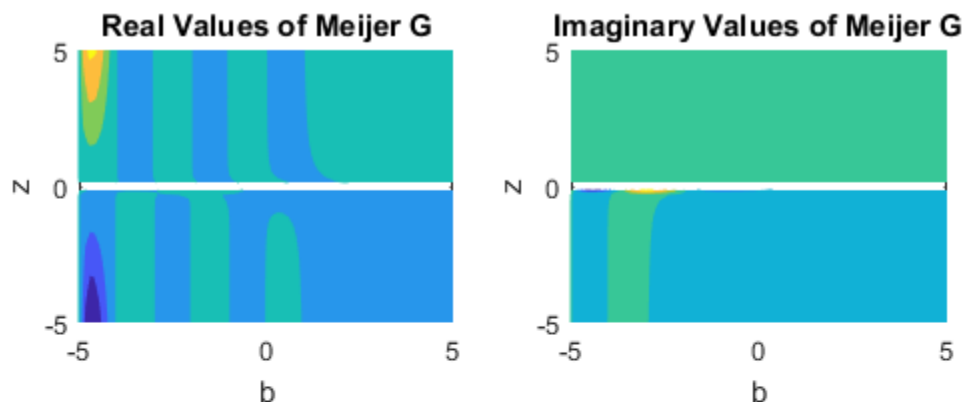

Input Arguments

a – Input

number | vector | symbolic number | symbolic variable | symbolic vector | symbolic function | symbolic expression

Input, specified as a number or vector, or a symbolic number, variable, vector, function, or expression.

b – Input

number | vector | symbolic number | symbolic variable | symbolic vector | symbolic function | symbolic expression

Input, specified as a number or vector, or a symbolic number, variable, vector, function, or expression.

c – Input

number | vector | symbolic number | symbolic variable | symbolic vector | symbolic function | symbolic expression

Input, specified as a number or vector, or a symbolic number, variable, vector, function, or expression.

d – Input

number | vector | symbolic number | symbolic variable | symbolic vector | symbolic function | symbolic expression

Input, specified as a number or vector, or a symbolic number, variable, vector, function, or expression.

z – Input

number | vector | symbolic number | symbolic variable | symbolic vector | symbolic matrix | symbolic multidimensional array | symbolic function | symbolic expression

Input, specified as a number or vector, or a symbolic number, variable, vector, function, or expression.

More About**Meijer G-Function**

The Meijer G-function $\text{meijerG}([a_1, \dots, a_n], [a_{n+1}, \dots, a_p], [b_1, \dots, b_m], [b_{m+1}, \dots, b_q], z)$ is a general function that includes other special functions as particular cases, and is defined as

$$G_{p,q}^{m,n} \left(\begin{matrix} a_1, \dots, a_p \\ b_1, \dots, b_q \end{matrix} \middle| z \right) = \frac{1}{2\pi i} \int \frac{\left(\prod_{j=1}^m \Gamma(b_j - s) \right) \left(\prod_{j=1}^n \Gamma(1 - a_j + s) \right)}{\left(\prod_{j=m+1}^q \Gamma(1 - b_j + s) \right) \left(\prod_{j=n+1}^p \Gamma(a_j - s) \right)} z^s ds.$$

Algorithms

For the Meijer G-function $\text{meijerG}([a_1, \dots, a_n], [a_{n+1}, \dots, a_p], [b_1, \dots, b_m], [b_{m+1}, \dots, b_q], z)$, for $a_i \in (a_1, \dots, a_n)$ and $b_j \in (b_1, \dots, b_m)$, no difference $a_i - b_j$ should be a positive integer.

The Meijer G-function involves a complex contour integral with one of the following types of integration paths:

- The contour goes from $-i\infty$ to $i\infty$ so that all poles of $\Gamma(b_j - s)$, $j = 1, \dots, m$ lie to the right of the path, and all poles of $\Gamma(1 - a_k + s)$, $k = 1, \dots, n$ lie to the left of the path. The integral converges if $c = m + n - \frac{p+q}{2} > 0$, $|\arg(z)| < c\pi$. If $|\arg(z)| = c\pi$, $c \geq 0$, the integral converges absolutely

when $p = q$ and $\Re(\psi) < -1$, where $\Psi = \left(\sum_{j=1}^q b_j \right) - \left(\sum_{i=1}^p a_i \right)$. When $p \neq q$, the integral converges if

you choose the contour so that the contour points near $i\infty$ and $-i\infty$ have a real part σ satisfying $(q-p)\sigma > \Re(\psi) + 1 - \frac{q-p}{2}$.

- The contour is a loop beginning and ending at *infinity* and encircling all poles of $\Gamma(b_j - s)$, $j = 1, \dots, m$ moving in the negative direction, but none of the poles of $\Gamma(1 - a_k + s)$, $k = 1, \dots, n$. The integral converges if $q \geq 1$ and either $p < q$ or $p = q$ and $|z| < 1$.
- The contour is a loop beginning and ending at $-\infty$ and encircling all poles of $\Gamma(1 - a_k + s)$, $k = 1, \dots, n$ moving in the positive direction, but none of the poles of $\Gamma(b_j - s)$, $j = 1, \dots, m$. The integral converges if $p \geq 1$ and either $p > q$ or $p = q$ and $|z| > 1$.

The integral represents an inverse Laplace transform or, more specifically, a Mellin-Barnes type of integral.

For a given set of parameters, the contour chosen in the definition of the Meijer G-function is the one for which the integral converges. If the integral converges for several contours, all contours lead to the same function.

The Meijer G-function satisfies a differential equation of order $\max(p, q)$ with respect to a variable z :

$$\left((-1)^{m+n-p} z \left(\prod_{i=1}^p \left(z \frac{d}{dz} - a_i - 1 \right) - \prod_{j=1}^q \left(z \frac{d}{dz} - b_j \right) \right) G_{p,q}^{m,n} \left(\begin{matrix} a_1, \dots, a_p \\ b_1, \dots, b_p \end{matrix} \middle| z \right) = 0.$$

If $p < q$, this differential equation has a regular singularity at $z = 0$ and an irregular singularity at $z = \infty$. If $p = q$, the points $z = 0$ and $z = \infty$ are regular singularities, and there is an additional regular singularity at $z = (-1)^{m+n-p}$.

The Meijer G-function represents an analytic continuation of the hypergeometric function [1]. For particular choices of parameters, you can express the Meijer G-function through the hypergeometric function. For example, if no two of the b_h terms, $h = 1, \dots, m$, differ by an integer or zero and all poles are simple, then

$$G_{p,q}^{m,n} \left(\begin{matrix} a_1, \dots, a_p \\ b_1, \dots, b_p \end{matrix} \middle| z \right) = \sum_{h=1}^m \frac{\left(\prod_{j=1, \dots, m, j \neq h} \Gamma(b_j - b_h) \right) \left(\prod_{j=1}^n \Gamma(1 + b_h - a_j) \right)}{\left(\prod_{j=m+1}^q \Gamma(1 + b_h - b_j) \right) \left(\prod_{j=n+1}^p \Gamma(a_j - b_h) \right)} z^{b_h} {}_pF_{q-1} \left(\begin{matrix} A_h; B_h; (-1)^{p-m-n} z \end{matrix} \right).$$

Here $p < q$ or $p = q$ and $|z| < 1$. A_h denotes

$$A_h = 1 + b_h - a_1, \dots, 1 + b_h - a_p.$$

B_h denotes

$$B_h = 1 + b_h - b_1, \dots, 1 + b_h - b_{(h-1)}, 1 + b_h - b_{h+1}, \dots, 1 + b_h - b_q.$$

Meijer G-functions with different parameters can represent the same function.

- The Meijer G-function is symmetric with respect to the parameters. Changing the order inside each of the following lists of vectors does not change the resulting Meijer G-function: $[a_1, \dots, a_n]$, $[a_{n+1}, \dots, a_p]$, $[b_1, \dots, b_m]$, $[b_{m+1}, \dots, b_q]$.
- If z is not a negative real number and $z \neq 0$, the function satisfies the following identity:

$$G_{p,q}^{m,n} \left(\begin{matrix} a_1, \dots, a_p \\ b_1, \dots, b_q \end{matrix} \middle| z \right) = G_{q,p}^{n,m} \left(\begin{matrix} 1 - b_1, \dots, 1 - b_p \\ 1 - a_1, \dots, 1 - a_p \end{matrix} \middle| \frac{1}{z} \right).$$

- If $0 < n < p$ and $r = a_1 - a_p$ is an integer, the function satisfies the following identity:

$$G_{p,q}^{m,n} \left(\begin{matrix} a_1, a_2, \dots, a_{p-1}, a_p \\ b_1, b_2, \dots, b_{q-1}, b_q \end{matrix} \middle| z \right) = G_{p,q}^{m,n} \left(\begin{matrix} a_p, a_2, \dots, a_{p-1}, a_1 \\ b_1, b_2, \dots, b_{q-1}, b_q \end{matrix} \middle| z \right).$$

- If $0 < m < q$ and $r = b_1 - b_q$ is an integer, the function satisfies the following identity:

$$G_{p,q}^{m,n} \left(\begin{matrix} a_1, a_2, \dots, a_{p-1}, a_p \\ b_1, b_2, \dots, b_{q-1}, b_q \end{matrix} \middle| z \right) = (-1)^r G_{p,q}^{m,n} \left(\begin{matrix} a_1, a_2, \dots, a_{p-1}, a_p \\ b_q, b_2, \dots, b_{q-1}, b_1 \end{matrix} \middle| z \right).$$

According to these rules, the `meijerG` function call can return `meijerG` with modified input parameters.

References

- [1] Luke, Y. L., *The Special Functions and Their Approximations*. Vol. 1. New York: Academic Press, 1969.
- [2] Prudnikov, A. P., Yu. A. Brychkov, and O. I. Marichev, *Integrals and Series*. Vol 3: More Special Functions. Gordon and Breach, 1990.
- [3] Abramowitz, M., I. A. Stegun, *Handbook of Mathematical Functions*. 9th printing. New York: Dover Publications, 1970.

See Also

hypergeom

Introduced in R2017b

mfun

Numeric evaluation of special mathematical function

Note `mfun` has been removed. Instead, use the appropriate special function listed in “Special Functions”. For example, use `bernoulli(n)` instead of `mfun('bernoulli',n)`.

Syntax

```
mfun('function',par1,par2,par3,par4)
```

Description

`mfun('function',par1,par2,par3,par4)` numerically evaluates one of the special mathematical functions. Each `par` argument is a numeric quantity corresponding to a parameter for `function`. You can use up to four parameters. The last parameter specified can be a matrix, usually corresponding to X . The dimensions of all other parameters depend on the specifications for `function`.

MuPAD software evaluates `function` using 16-digit accuracy. Each element of the result is a MATLAB numeric quantity. Any singularity in `function` is returned as `NaN`.

Compatibility Considerations

mfun has been removed

Errors starting in R2019b

`mfun` has been removed. Use the appropriate special function instead. For example, use `bernoulli(n)` instead of `mfun('bernoulli',n)`.

See Also

`mfunlist`

Introduced before R2006a

mfunlist

List special functions for use with `mfun`

Note `mfunlist` has been removed. Instead, use the appropriate special function syntax listed in “Special Functions”. For example, use `bernoulli(n)` instead of `mfun('bernoulli',n)`.

Syntax

`mfunlist`

Description

`mfunlist` lists the special mathematical functions for use with the `mfun` function.

More About

Special Functions

The following tables describe the appropriate special functions to replace `mfunlist`. The following conventions are used in the next table, unless otherwise indicated in the **Arguments** column.

- x, y for real argument
- $z, z1, z2$ for complex argument
- m, n for integer argument

mfun Special Functions

Function Name	Definition	mfun Name	Special Function Syntax	Arguments
Bernoulli numbers and polynomials	Generating functions: $\frac{e^{xt}}{e^t - 1} = \sum_{n=0}^{\infty} B_n(x) \cdot \frac{t^{n-1}}{n!}$	bernoulli(n) bernoulli(n, t)	bernoulli(n) bernoulli(n, t)	$n \geq 0$ $0 < t < 2\pi$
Bessel functions	BesselI, BesselJ—Bessel functions of the first kind. BesselK, BesselY—Bessel functions of the second kind.	BesselJ(v, x) BesselY(v, x) BesselI(v, x) BesselK(v, x)	besselj(v, x) bessely(v, x) besseli(v, x) besselk(v, x)	v is real.
Beta function	$B(x, y) = \frac{\Gamma(x) \cdot \Gamma(y)}{\Gamma(x + y)}$	Beta(x, y)	beta(x, y)	
Binomial coefficients	$\binom{m}{n} = \frac{m!}{n!(m-n)!}$ $= \frac{\Gamma(m+1)}{\Gamma(n+1)\Gamma(m-n+1)}$	binomial(m, n)	nchoosek(m, n)	
Complete elliptic integrals	Legendre's complete elliptic integrals of the first, second, and third kind. This definition uses modulus k . The numerical <code>ellipke</code> function and the MuPAD functions for computing elliptic integrals use the parameter $m = k^2 = \sin^2\alpha$.	EllipticK(k) EllipticE(k) EllipticPi(a, k)	ellipticK(k) ellipticE(k) ellipticPi(a, k)	a is real, $-\infty < a < \infty$. k is real, $0 < k < 1$.
Complete elliptic integrals with complementary modulus	Associated complete elliptic integrals of the first, second, and third kind using complementary modulus. This definition uses modulus k . The numerical <code>ellipke</code> function and the MuPAD functions for computing elliptic integrals use the parameter $m = k^2 = \sin^2\alpha$.	EllipticCK(k) EllipticCE(k) EllipticCPi(a, k)	ellipticCK(k) ellipticCE(k) ellipticCPi(a, k)	a is real, $-\infty < a < \infty$. k is real, $0 < k < 1$.

Function Name	Definition	mfun Name	Special Function Syntax	Arguments
Complementary error function and its iterated integrals	$\operatorname{erfc}(z) = \frac{2}{\sqrt{\pi}} \cdot \int_z^{\infty} e^{-t^2} dt = 1 - \operatorname{erf}(z)$ $\operatorname{erfc}(-1, z) = \frac{2}{\sqrt{\pi}} \cdot e^{-z^2}$ $\operatorname{erfc}(n, z) = \int_z^{\infty} \operatorname{erfc}(n-1, t) dt$	$\operatorname{erfc}(z)$ $\operatorname{erfc}(n, z)$	$\operatorname{erfc}(z)$ $\operatorname{erfc}(n, z)$	$n > 0$
Dawson's integral	$F(x) = e^{-x^2} \cdot \int_0^x e^{t^2} dt$	$\operatorname{dawson}(x)$	$\operatorname{dawson}(x)$	
Digamma function	$\Psi(x) = \frac{d}{dx} \ln(\Gamma(x)) = \frac{\Gamma'(x)}{\Gamma(x)}$	$\operatorname{Psi}(x)$	$\operatorname{psi}(x)$	
Dilogarithm integral	$f(x) = \int_1^x \frac{\ln(t)}{1-t} dt$	$\operatorname{dilog}(x)$	$\operatorname{dilog}(x)$	$x > 1$
Error function	$\operatorname{erf}(z) = \frac{2}{\sqrt{\pi}} \int_0^z e^{-t^2} dt$	$\operatorname{erf}(z)$	$\operatorname{erf}(z)$	
Euler numbers and polynomials	Generating function for Euler numbers: $\frac{1}{\cosh(t)} = \sum_{n=0}^{\infty} E_n \frac{t^n}{n!}$	$\operatorname{euler}(n)$ $\operatorname{euler}(n, z)$	$\operatorname{euler}(n)$ $\operatorname{euler}(n, z)$	$n \geq 0$ $ t < \frac{\pi}{2}$
Exponential integrals	$Ei(n, z) = \int_1^{\infty} \frac{e^{-zt}}{t^n} dt$ $Ei(x) = PV \left(- \int_{-\infty}^x \frac{e^t}{t} \right)$	$Ei(n, z)$ $Ei(x)$	$\operatorname{expint}(n, x)$ $\operatorname{ei}(x)$	$n \geq 0$ $\operatorname{Real}(z) > 0$
Fresnel sine and cosine integrals	$C(x) = \int_0^x \cos\left(\frac{\pi}{2} t^2\right) dt$ $S(x) = \int_0^x \sin\left(\frac{\pi}{2} t^2\right) dt$	$\operatorname{FresnelC}(x)$ $\operatorname{FresnelS}(x)$	$\operatorname{fresnelc}(x)$ $\operatorname{fresnels}(x)$	
Gamma function	$\Gamma(z) = \int_0^{\infty} t^{z-1} e^{-t} dt$	$\operatorname{GAMMA}(z)$	$\operatorname{gamma}(z)$	

Function Name	Definition	mfun Name	Special Function Syntax	Arguments
Harmonic function	$h(n) = \sum_{k=1}^n \frac{1}{k} = \Psi(n+1) + \gamma$	harmonic(n)	harmonic(n)	$n > 0$
Hyperbolic sine and cosine integrals	$Shi(z) = \int_0^z \frac{\sinh(t)}{t} dt$ $Chi(z) = \gamma + \ln(z) + \int_0^z \frac{\cosh(t) - 1}{t} dt$	Shi(z) Chi(z)	sinhint(z) coshint(z)	
(Generalized) hypergeometric function	$F(n, d, z) = \sum_{k=0}^{\infty} \frac{\prod_{i=1}^j \frac{\Gamma(n_i + k)}{\Gamma(n_i)} \cdot z^k}{\prod_{i=1}^m \frac{\Gamma(d_i + k)}{\Gamma(d_i)} \cdot k!}$ <p>where j and m are the number of terms in n and d, respectively.</p>	hypergeom(n, d, x) where $n = [n1, n2, \dots]$ $d = [d1, d2, \dots]$	hypergeom(n, d, x) where $n = [n1, n2, \dots]$ $d = [d1, d2, \dots]$	$n1, n2, \dots$ are real. $d1, d2, \dots$ are real and nonnegative.
Incomplete elliptic integrals	Legendre's incomplete elliptic integrals of the first, second, and third kind. This definition uses modulus k . The numerical <code>ellipke</code> function and the MuPAD functions for computing elliptic integrals use the parameter $m = k^2 = \sin^2 \alpha$.	EllipticF(x, k) EllipticE(x, k) EllipticPi(x, a, k)	ellipticF(x, k) ellipticF(x, k) ellipticPi(x, a, k)	$0 < x \leq \infty$. a is real, $-\infty < a < \infty$. k is real, $0 < k < 1$.
Incomplete gamma function	$\Gamma(a, z) = \int_z^{\infty} e^{-t} \cdot t^{a-1} dt$	GAMMA(z1, z2) $z1 = a$ $z2 = z$	igamma(z1, z2) $z1 = a$ $z2 = z$	
Logarithm of the gamma function	$\ln\text{GAMMA}(z) = \ln(\Gamma(z))$	lnGAMMA(z)	gamma ln(z)	
Logarithmic integral	$Li(x) = PV \left\{ \int_0^x \frac{dt}{\ln t} \right\} = Ei(\ln x)$	Li(x)	logint(x)	$x > 1$
Polygamma function	$\Psi^{(n)}(z) = \frac{d^n}{dz^n} \Psi(z)$ <p>where $\Psi(z)$ is the Digamma function.</p>	Psi(n, z)	psi(n, z)	$n \geq 0$
Shifted sine integral	$Ssi(z) = Si(z) - \frac{\pi}{2}$	Ssi(z)	ssinint(z)	

The following orthogonal polynomials are available using `mfun`. In all cases, n is a nonnegative integer and x is real.

Polynomial	mfun Name	Special Function Syntax	Arguments
Chebyshev of the first and second kind	$T(n, x)$	<code>chebyshevT(n, x)</code>	
	$U(n, x)$	<code>chebyshevU(n, x)</code>	
Gegenbauer	$G(n, a, x)$	<code>gegenbauerC(n, a, x)</code>	a is a nonrational algebraic expression or a rational number greater than $-1/2$.
Hermite	$H(n, x)$	<code>hermiteH(n, x)</code>	
Jacobi	$P(n, a, b, x)$	<code>jacobiP(n, a, b, x)</code>	a, b are nonrational algebraic expressions or rational numbers greater than -1 .
Laguerre	$L(n, x)$	<code>laguerreL(n, x)</code>	
Generalized Laguerre	$L(n, a, x)$	<code>laguerreL(n, a, x)</code>	a is a nonrational algebraic expression or a rational number greater than -1 .
Legendre	$P(n, x)$	<code>legendreP(n, x)</code>	

Compatibility Considerations

mfunlist has been removed

Errors starting in R2019b

`mfunlist` has been removed. Use the appropriate special function instead. For example, use `bernoulli(n)` instead of `mfun('bernoulli', n)`.

See Also

`mfun`

Introduced before R2006a

minpoly

Minimal polynomial of matrix

Syntax

```
minpoly(A)  
minpoly(A,var)
```

Description

`minpoly(A)` returns a vector of the coefficients of the minimal polynomial on page 4-967 of A. If A is a symbolic matrix, `minpoly` returns a symbolic vector. Otherwise, it returns a vector with elements of type double.

`minpoly(A,var)` returns the minimal polynomial of A in terms of var.

Examples

Compute Minimal Polynomial of Matrix

Compute the minimal polynomial of the matrix A in terms of the variable x:

```
syms x  
A = sym([1 1 0; 0 1 0; 0 0 1]);  
minpoly(A, x)
```

```
ans =  
x^2 - 2*x + 1
```

Compute Coefficients of Minimal Polynomial

To find the coefficients of the minimal polynomial of A, call `minpoly` with one argument. Since A is numeric, `minpoly` returns coefficients as double-precision values:

```
A = sym([1 1 0; 0 1 0; 0 0 1]);  
minpoly(A)
```

```
ans =  
[ 1, -2, 1]
```

Find the coefficients of the minimal polynomial of the symbolic matrix A. For this matrix, `minpoly` returns the symbolic vector of coefficients:

```
A = sym([0 2 0; 0 0 2; 2 0 0]);  
P = minpoly(A)
```

```
P =  
[ 1, 0, 0, -8]
```

Input Arguments

A — Input

numeric matrix | symbolic matrix

Input, specified as a numeric or symbolic matrix.

var — Input

symbolic variable

Input, specified as a symbolic variable. If you do not specify `var`, `minpoly` returns a vector of coefficients of the minimal polynomial instead of returning the polynomial itself.

More About

Minimal Polynomial of a Matrix

The minimal polynomial of a square matrix A is the monic polynomial $p(x)$ of the least degree, such that $p(A) = 0$.

See Also

`charpoly` | `eig` | `jordan` | `poly2sym` | `sym2poly`

Introduced in R2012b

minus, -

Symbolic subtraction

Syntax

```
-A  
A - B  
minus(A,B)
```

Description

-A returns the negation of A.

A - B subtracts B from A and returns the result.

minus(A,B) is an alternate way to execute A - B.

Examples

Subtract Scalar from Array

Subtract 2 from array A.

```
syms x  
A = [x 1; -2 sin(x)];  
A - 2
```

```
ans =  
[ x - 2,          -1]  
[   -4, sin(x) - 2]
```

minus subtracts 2 from each element of A.

Subtract the identity matrix from matrix M:

```
syms x y z  
M = [0 x; y z];  
M - eye(2)
```

```
ans =  
[ -1,    x]  
[  y, z - 1]
```

Subtract Numeric and Symbolic Arguments

Subtract one number from another. Because these are not symbolic objects, you receive floating-point results.

```
11/6 - 5/4
```

```
ans =  
0.5833
```

Perform subtraction symbolically by converting the numbers to symbolic objects.

```
sym(11/6) - sym(5/4)
```

```
ans =  
7/12
```

Alternatively, call `minus` to perform subtraction.

```
minus(sym(11/6),sym(5/4))
```

```
ans =  
7/12
```

Subtract Matrices

Subtract matrices B and C from A.

```
A = sym([3 4; 2 1]);  
B = sym([8 1; 5 2]);  
C = sym([6 3; 4 9]);  
Y = A - B - C
```

```
Y =  
[ -11,  0]  
[ -7, -10]
```

Use syntax `-Y` to negate the elements of Y.

```
-Y
```

```
ans =  
[ 11,  0]  
[  7, 10]
```

Subtract Functions

Subtract function g from function f.

```
syms f(x) g(x)  
f = sin(x) + 2*x;  
y = f - g
```

```
y(x) =  
2*x - g(x) + sin(x)
```

Input Arguments

A — Input

symbolic variable | symbolic vector | symbolic matrix | symbolic multidimensional array | symbolic function | symbolic expression

Input, specified as a symbolic variable, vector, matrix, multidimensional array, function, or expression.

B — Input

symbolic variable | symbolic vector | symbolic matrix | symbolic multidimensional array | symbolic function | symbolic expression

Input, specified as a symbolic variable, vector, matrix, multidimensional array, function, or expression.

Tips

- All nonscalar arguments must have the same size. If one input argument is nonscalar, then `minus` expands the scalar into an array of the same size as the nonscalar argument, with all elements equal to the corresponding scalar.

See Also

`ctranspose` | `ldivide` | `mldivide` | `mpower` | `mrdivide` | `mtimes` | `plus` | `power` | `rdivide` | `times` | `transpose`

Introduced before R2006a

mixedUnits

Split unit into sum of units

Syntax

```
mixedUnits(quantity,units)
```

Description

`mixedUnits(quantity,units)` splits the physical quantity `quantity` into a linear combination of the units in `units`.

- Units in `units` must be in descending order of magnitude.
- Units in `quantity` and `units` must be compatible.
- `quantity` must not contain symbolic variables.

Examples

Split Quantity into Combination of Units

Split 8000 seconds into hours, minutes, and seconds by using `mixedUnits`. The result is 2 hours, 13 minutes, and 20 seconds.

```
u = symunit;
t = 8000*u.s;
tunits = [u.hour u.minute u.second];
tSplit = mixedUnits(t,tunits)
```

```
tSplit =
 [ 2, 13, 20]
```

Customize the displayed output by using `compose`.

```
compose("%d hours + %d minutes + %.1f seconds", double(tSplit))
```

```
ans =
    "2 hours + 13 minutes + 20.0 seconds"
```

Convert the geographic coordinate 15.352° into degrees ($^\circ$), arcminutes ($'$), and arcseconds ($''$). The result is $15^\circ 21' 36/5''$.

```
gCoord = 15.352*u.degree;
gUnits = [u.degree u.arcmin u.arcsec];
gCoordSplit = mixedUnits(gCoord,gUnits)
```

```
gCoordSplit =
 [ 15, 21, 36/5]
```

Convert the result from symbolic to floating point by using `double`.

```
gCoordDb1 = double(gCoordSplit)
```

```
gCoordDbl =  
    15.0000    21.0000    7.2000
```

Reconstruct the original coordinate by summing the split units and rewriting the result to degrees. `mixedUnits` returns an exact symbolic result instead of a numeric approximation. For details, see “Choose Numeric or Symbolic Arithmetic” on page 2-124.

```
gOrig = sum(gCoordSplit.*gUnits);  
gOrig = rewrite(gOrig,u.degree)
```

```
gOrig =  
(1919/125)*[deg]
```

Input Arguments

quantity – Input

symbolic expression with units

Input, specified as a symbolic expression with units. `quantity` must not contain symbolic variables. Units in `quantity` and `units` must be compatible.

units – Units for representing input

vector of symbolic units

Units to represent input as, specified as a vector of symbolic units. Units must be in descending order of magnitude. Units in `quantity` and `units` must be compatible.

See Also

`symunit` | `unitConversionFactor`

Topics

“Units of Measurement Tutorial” on page 2-19

“Unit Conversions and Unit Systems” on page 2-39

“Units and Unit Systems List” on page 2-25

Introduced in R2018a

mldivide, \

Symbolic matrix left division

Syntax

```
X = A\B
X = mldivide(A,B)
```

Description

$X = A \setminus B$ solves the symbolic system of linear equations in matrix form, $A * X = B$ for X .

If the solution does not exist or if it is not unique, the \setminus operator issues a warning.

A can be a rectangular matrix, but the equations must be consistent. The symbolic operator \setminus does not compute least-squares solutions.

$X = \text{mldivide}(A,B)$ is equivalent to $x = A \setminus B$.

Examples

System of Equations in Matrix Form

Solve a system of linear equations specified by a square matrix of coefficients and a vector of right sides of equations.

Create a matrix containing the coefficient of equation terms, and a vector containing the right sides of equations.

```
A = sym(pascal(4))
b = sym([4; 3; 2; 1])
```

```
A =
[ 1, 1, 1, 1]
[ 1, 2, 3, 4]
[ 1, 3, 6, 10]
[ 1, 4, 10, 20]
```

```
b =
4
3
2
1
```

Use the operator \setminus to solve this system.

```
X = A\b
```

```
X =
5
-1
0
0
```

Rank-Deficient System

Create a matrix containing the coefficients of equation terms, and a vector containing the right sides of equations.

```
A = sym(magic(4))
b = sym([0; 1; 1; 0])
```

```
A =
[ 16,  2,  3, 13]
[  5, 11, 10,  8]
[  9,  7,  6, 12]
[  4, 14, 15,  1]
```

```
b =
 0
 1
 1
 0
```

Find the rank of the system. This system contains four equations, but its rank is 3. Therefore, the system is rank-deficient. This means that one variable of the system is not independent and can be expressed in terms of other variables.

```
rank(horzcat(A,b))
```

```
ans =
 3
```

Try to solve this system using the symbolic `\` operator. Because the system is rank-deficient, the returned solution is not unique.

```
A\b
```

```
Warning: Solution is not unique because the system is rank-deficient.
```

```
ans =
 1/34
19/34
-9/17
  0
```

Inconsistent System

Create a matrix containing the coefficient of equation terms, and a vector containing the right sides of equations.

```
A = sym(magic(4))
b = sym([0; 1; 2; 3])
```

```
A =
[ 16,  2,  3, 13]
[  5, 11, 10,  8]
[  9,  7,  6, 12]
[  4, 14, 15,  1]
```

```
b =
 0
```

```
1
2
3
```

Try to solve this system using the symbolic `\` operator. The operator issues a warning and returns a vector with all elements set to `Inf` because the system of equations is inconsistent, and therefore, no solution exists. The number of elements in the resulting vector equals the number of equations (rows in the coefficient matrix).

```
A\b
```

```
Warning: Solution does not exist because the system is inconsistent.
```

```
ans =
    Inf
    Inf
    Inf
    Inf
```

Find the reduced row echelon form of this system. The last row shows that one of the equations reduced to $0 = 1$, which means that the system of equations is inconsistent.

```
rref(horzcat(A,b))
```

```
ans =
[ 1, 0, 0, 1, 0]
[ 0, 1, 0, 3, 0]
[ 0, 0, 1, -3, 0]
[ 0, 0, 0, 0, 1]
```

Input Arguments

A — Coefficient matrix

symbolic number | symbolic variable | symbolic function | symbolic expression | symbolic vector | symbolic matrix

Coefficient matrix, specified as a symbolic number, variable, expression, function, vector, or matrix.

B — Right side

symbolic number | symbolic variable | symbolic function | symbolic expression | symbolic vector | symbolic matrix

Right side, specified as a symbolic number, variable, expression, function, vector, or matrix.

Output Arguments

X — Solution

symbolic number | symbolic variable | symbolic function | symbolic expression | symbolic vector | symbolic matrix

Solution, returned as a symbolic number, variable, expression, function, vector, or matrix.

Tips

- Matrix computations involving many symbolic variables can be slow. To increase the computational speed, reduce the number of symbolic variables by substituting the given values for some variables.
- When dividing by zero, `mldivide` considers the numerator's sign and returns `Inf` or `-Inf` accordingly.

```
syms x  
[sym(0)\sym(1), sym(0)\sym(-1), sym(0)\x]
```

```
ans =  
[ Inf, -Inf, Inf*x]
```

See Also

`ctranspose` | `ldivide` | `minus` | `mpower` | `mrdivide` | `mtimes` | `plus` | `power` | `rdivide` | `times` | `transpose`

Introduced before R2006a

mod

Symbolic modulus after division

Note In a future release, `mod` will no longer find the modulus for each coefficient of a symbolic polynomial. Instead, `mod(a, b)` will return an unevaluated symbolic expression if `a` is a polynomial and `b` is a real number. To find the modulus for each coefficient of the polynomial `a`, use `[c, t] = coeffs(a); sum(mod(c, b).*t)`.

Syntax

`mod(a, b)`

Description

`mod(a, b)` finds the modulus on page 4-978 after division. To find the remainder, use `rem`.

If `a` is a polynomial expression, then `mod(a, b)` finds the modulus for each coefficient.

Examples

Divide Integers by Integers

Find the modulus after division in case both the dividend and divisor are integers.

Find the modulus after division for these numbers.

```
[mod(sym(27), 4), mod(sym(27), -4), mod(sym(-27), 4), mod(sym(-27), -4)]
```

```
ans =  
[ 3, -1, 1, -3]
```

Divide Rationals by Integers

Find the modulus after division in case the dividend is a rational number, and divisor is an integer.

Find the modulus after division for these numbers.

```
[mod(sym(22/3), 5), mod(sym(1/2), 7), mod(sym(27/6), -11)]
```

```
ans =  
[ 7/3, 1/2, -13/2]
```

Divide Polynomial Expressions by Integers

Find the modulus after division in case the dividend is a polynomial expression, and divisor is an integer. If the dividend is a polynomial expression, then `mod` finds the modulus for each coefficient.

Find the modulus after division for these polynomial expressions.

```
syms x  
mod(x^3 - 2*x + 999, 10)
```

```
ans =
x^3 + 8*x + 9
```

```
mod(8*x^3 + 9*x^2 + 10*x + 11, 7)
```

```
ans =
x^3 + 2*x^2 + 3*x + 4
```

Divide Elements of Matrices

For vectors and matrices, `mod` finds the modulus after division element-wise. Nonscalar arguments must be the same size.

Find the modulus after division for the elements of these two matrices.

```
A = sym([27, 28; 29, 30]);
B = sym([2, 3; 4, 5]);
mod(A,B)
```

```
ans =
[ 1, 1]
[ 1, 0]
```

Find the modulus after division for the elements of matrix A and the value 9. Here, `mod` expands 9 into the 2-by-2 matrix with all elements equal to 9.

```
mod(A,9)
```

```
ans =
[ 0, 1]
[ 2, 3]
```

Input Arguments

a — Dividend (numerator)

number | symbolic number | symbolic variable | polynomial expression | vector | matrix

Dividend (numerator), specified as a number, symbolic number, variable, polynomial expression, or a vector or matrix of numbers, symbolic numbers, variables, or polynomial expressions.

b — Divisor (denominator)

number | symbolic number | vector | matrix

Divisor (denominator), specified as a number, symbolic number, or a vector or matrix of numbers or symbolic numbers.

More About

Modulus

The modulus of a and b is

$$\text{mod}(a, b) = a - b * \text{floor}\left(\frac{a}{b}\right),$$

where `floor` rounds (a/b) towards negative infinity. For example, the modulus of -8 and -3 is -2, but the modulus of -8 and 3 is 1.

If $b = 0$, then $\text{mod}(a,0) = 0$.

Tips

- Calling `mod` for numbers that are not symbolic objects invokes the MATLAB `mod` function.
- All nonscalar arguments must be the same size. If one input argument is nonscalar, then `mod` expands the scalar into a vector or matrix of the same size as the nonscalar argument, with all elements equal to the corresponding scalar.

Compatibility Considerations

mod will no longer find the modulus for each coefficient of a symbolic polynomial

Behavior change in future release

In a future release, `mod` will no longer find the modulus for each coefficient of a symbolic polynomial. Instead, `mod(a,b)` will return an unevaluated symbolic expression if `a` is a symbolic polynomial and `b` is a real number. To find the modulus for each coefficient of the polynomial `a`, use `[c,t] = coeffs(a); sum(mod(c,b).*t)`.

See Also

`coeffs` | `powermod` | `quorem` | `rem`

Introduced before R2006a

mpower, ^

Symbolic matrix power

Syntax

```
A^B  
mpower(A,B)
```

Description

A^B computes A to the B power.

`mpower(A,B)` is equivalent to A^B .

Examples

Matrix Base and Scalar Exponent

Create a 2-by-2 matrix.

```
A = sym('a%d%d', [2 2])
```

```
A =  
[ a11, a12]  
[ a21, a22]
```

Find A^2 .

```
A^2  
  
ans =  
[ a11^2 + a12*a21, a11*a12 + a12*a22]  
[ a11*a21 + a21*a22, a22^2 + a12*a21]
```

Scalar Base and Matrix Exponent

Create a 2-by-2 symbolic magic square.

```
A = sym(magic(2))
```

```
A =  
[ 1, 3]  
[ 4, 2]
```

Find π^A .

```
sym(pi)^A  
  
ans =  
[ (3*pi^7 + 4)/(7*pi^2), (3*(pi^7 - 1))/(7*pi^2)]  
[ (4*(pi^7 - 1))/(7*pi^2), (4*pi^7 + 3)/(7*pi^2)]
```

Input Arguments

A — Base

number | symbolic number | symbolic variable | symbolic function | symbolic expression | square symbolic matrix

Base, specified as a number or a symbolic number, variable, expression, function, or square matrix. A and B must be one of the following:

- Both are scalars.
- A is a square matrix, and B is a scalar.
- B is a square matrix, and A is a scalar.

B — Exponent

number | symbolic number | symbolic variable | symbolic function | symbolic expression | symbolic square matrix

Exponent, specified as a number or a symbolic number, variable, expression, function, or square matrix. A and B must be one of the following:

- Both are scalars.
- A is a square matrix, and B is a scalar.
- B is a square matrix, and A is a scalar.

See Also

ctranspose | ldivide | minus | mldivide | mrdivide | mtimes | plus | power | rdivide | times | transpose

Introduced before R2006a

mrdivide, /

Symbolic matrix right division

Syntax

```
X = B/A  
X = mrdivide(B,A)
```

Description

$X = B/A$ solves the symbolic system of linear equations in matrix form, $X*A = B$ for X . The matrices A and B must contain the same number of columns. The right division of matrices B/A is equivalent to $(A'\backslash B)'$.

If the solution does not exist or if it is not unique, the `/` operator issues a warning.

A can be a rectangular matrix, but the equations must be consistent. The symbolic operator `/` does not compute least-squares solutions.

$X = \text{mrdivide}(B,A)$ is equivalent to $x = B/A$.

Examples

System of Equations in Matrix Form

Solve a system of linear equations specified by a square matrix of coefficients and a vector of right sides of equations.

Create a matrix containing the coefficient of equation terms, and a vector containing the right sides of equations.

```
A = sym(pascal(4))  
b = sym([4 3 2 1])
```

```
A =  
[ 1, 1, 1, 1]  
[ 1, 2, 3, 4]  
[ 1, 3, 6, 10]  
[ 1, 4, 10, 20]
```

```
b =  
[ 4, 3, 2, 1]
```

Use the operator `/` to solve this system.

```
X = b/A
```

```
X =  
[ 5, -1, 0, 0]
```

Rank-Deficient System

Create a matrix containing the coefficient of equation terms, and a vector containing the right sides of equations.

```
A = sym(magic(4))'
b = sym([0 1 1 0])
```

```
A =
[ 16,  5,  9,  4]
[  2, 11,  7, 14]
[  3, 10,  6, 15]
[ 13,  8, 12,  1]
```

```
b =
[ 0, 1, 1, 0]
```

Find the rank of the system. This system contains four equations, but its rank is 3. Therefore, the system is rank-deficient. This means that one variable of the system is not independent and can be expressed in terms of other variables.

```
rank(vertcat(A,b))
```

```
ans =
3
```

Try to solve this system using the symbolic / operator. Because the system is rank-deficient, the returned solution is not unique.

```
b/A
```

```
Warning: Solution is not unique because the system is rank-deficient.
```

```
ans =
[ 1/34, 19/34, -9/17, 0]
```

Inconsistent System

Create a matrix containing the coefficient of equation terms, and a vector containing the right sides of equations.

```
A = sym(magic(4))'
b = sym([0 1 2 3])
```

```
A =
[ 16,  5,  9,  4]
[  2, 11,  7, 14]
[  3, 10,  6, 15]
[ 13,  8, 12,  1]
```

```
b =
[ 0, 1, 2, 3]
```

Try to solve this system using the symbolic / operator. The operator issues a warning and returns a vector with all elements set to `Inf` because the system of equations is inconsistent, and therefore, no solution exists. The number of elements equals the number of equations (rows in the coefficient matrix).

```
b/A
```

Warning: Solution does not exist because the system is inconsistent.

```
ans =  
[ Inf, Inf, Inf, Inf]
```

Find the reduced row echelon form of this system. The last row shows that one of the equations reduced to $0 = 1$, which means that the system of equations is inconsistent.

```
rref(vertcat(A,b)')
```

```
ans =  
[ 1, 0, 0, 1, 0]  
[ 0, 1, 0, 3, 0]  
[ 0, 0, 1, -3, 0]  
[ 0, 0, 0, 0, 1]
```

Input Arguments

A — Coefficient matrix

symbolic number | symbolic variable | symbolic function | symbolic expression | symbolic vector | symbolic matrix

Coefficient matrix, specified as a symbolic number, variable, expression, function, vector, or matrix.

B — Right side

symbolic number | symbolic variable | symbolic function | symbolic expression | symbolic vector | symbolic matrix

Right side, specified as a symbolic number, variable, expression, function, vector, or matrix.

Output Arguments

X — Solution

symbolic number | symbolic variable | symbolic function | symbolic expression | symbolic vector | symbolic matrix

Solution, returned as a symbolic number, variable, expression, function, vector, or matrix.

Tips

- Matrix computations involving many symbolic variables can be slow. To increase the computational speed, reduce the number of symbolic variables by substituting the given values for some variables.
- When dividing by zero, `mrdivide` considers the numerator's sign and returns `Inf` or `-Inf` accordingly.

```
syms x  
[sym(1)/sym(0), sym(-1)/sym(0), x/sym(0)]
```

```
ans =  
[ Inf, -Inf, Inf*x]
```

See Also

ctranspose | ldivide | minus | mldivide | mpower | mtimes | plus | power | rdivide | times | transpose

Introduced before R2006a

mtimes, *

Symbolic matrix multiplication

Syntax

```
A*B
mtimes(A,B)
```

Description

$A*B$ is the matrix product of A and B . If A is an m -by- p and B is a p -by- n matrix, then the result is an m -by- n matrix C defined as

$$C(i, j) = \sum_{k=1}^p A(i, k)B(k, j)$$

For nonscalar A and B , the number of columns of A must equal the number of rows of B . Matrix multiplication is not universally commutative for nonscalar inputs. That is, typically $A*B$ is not equal to $B*A$. If at least one input is scalar, then $A*B$ is equivalent to $A.*B$ and is commutative.

`mtimes(A,B)` is equivalent to `A*B`.

Examples

Multiply Two Vectors

Create a 1-by-5 row vector and a 5-by-1 column vector.

```
syms x
A = [x, 2*x^2, 3*x^3, 4*x^4]
B = [1/x; 2/x^2; 3/x^3; 4/x^4]
```

```
A =
[ x, 2*x^2, 3*x^3, 4*x^4]
```

```
B =
 1/x
2/x^2
3/x^3
4/x^4
```

Find the matrix product of these two vectors.

```
A*B
```

```
ans =
30
```

Multiply Two Matrices

Create a 4-by-3 matrix and a 3-by-2 matrix.

```
A = sym('a%d%d', [4 3])
B = sym('b%d%d', [3 2])
```

```
A =
[ a11, a12, a13]
[ a21, a22, a23]
[ a31, a32, a33]
[ a41, a42, a43]
```

```
B =
[ b11, b12]
[ b21, b22]
[ b31, b32]
```

Multiply A by B.

A*B

```
ans =
[ a11*b11 + a12*b21 + a13*b31, a11*b12 + a12*b22 + a13*b32]
[ a21*b11 + a22*b21 + a23*b31, a21*b12 + a22*b22 + a23*b32]
[ a31*b11 + a32*b21 + a33*b31, a31*b12 + a32*b22 + a33*b32]
[ a41*b11 + a42*b21 + a43*b31, a41*b12 + a42*b22 + a43*b32]
```

Multiply Matrix by Scalar

Create a 4-by-4 Hilbert matrix H.

```
H = sym(hilb(4))
```

```
H =
[ 1, 1/2, 1/3, 1/4]
[ 1/2, 1/3, 1/4, 1/5]
[ 1/3, 1/4, 1/5, 1/6]
[ 1/4, 1/5, 1/6, 1/7]
```

Multiply H by e^π .

```
C = H*exp(sym(pi))
```

```
C =
[ exp(pi), exp(pi)/2, exp(pi)/3, exp(pi)/4]
[ exp(pi)/2, exp(pi)/3, exp(pi)/4, exp(pi)/5]
[ exp(pi)/3, exp(pi)/4, exp(pi)/5, exp(pi)/6]
[ exp(pi)/4, exp(pi)/5, exp(pi)/6, exp(pi)/7]
```

Use `vpa` and `digits` to approximate symbolic results with the required number of digits. For example, approximate it with five-digit accuracy.

```
old = digits(5);
vpa(C)
digits(old)
```

```
ans =
[ 23.141, 11.57, 7.7136, 5.7852]
[ 11.57, 7.7136, 5.7852, 4.6281]
[ 7.7136, 5.7852, 4.6281, 3.8568]
[ 5.7852, 4.6281, 3.8568, 3.3058]
```

Input Arguments

A — Input

symbolic number | symbolic variable | symbolic function | symbolic expression | symbolic vector | symbolic matrix

Input, specified as a symbolic number, variable, expression, function, vector, or matrix. Inputs A and B must be the same size unless one is a scalar. A scalar value expands into an array of the same size as the other input.

B — Input

symbolic number | symbolic variable | symbolic function | symbolic expression | symbolic vector | symbolic matrix

Input, specified as a symbolic number, variable, expression, function, vector, or matrix. Inputs A and B must be the same size unless one is a scalar. A scalar value expands into an array of the same size as the other input.

See Also

ctranspose | ldivide | minus | mldivide | mpower | mrdivide | plus | power | rdivide | times | transpose

Introduced before R2006a

mupad

(Removed) Start MuPAD notebook

Note

MuPAD® notebook has been removed. Use MATLAB® Live Editor instead.

To convert a MuPAD notebook file to a MATLAB live script file, see `convertMuPADNotebook`. MATLAB live scripts support most MuPAD functionality, although there are some differences. For more information, see “Convert MuPAD Notebooks to MATLAB Live Scripts”.

Syntax

`mupad filename`

Description

`mupad filename` opens the MuPAD notebook named `filename`. The file name must be a full path unless the file is in the current folder.

Examples

Open MuPAD Notebook

Open an existing notebook named `notebook1.mn` located in the current folder.

```
mupad 'notebook1.mn';
```

When you open an existing MuPAD notebook, you can choose to convert the notebook to MATLAB live script instead.

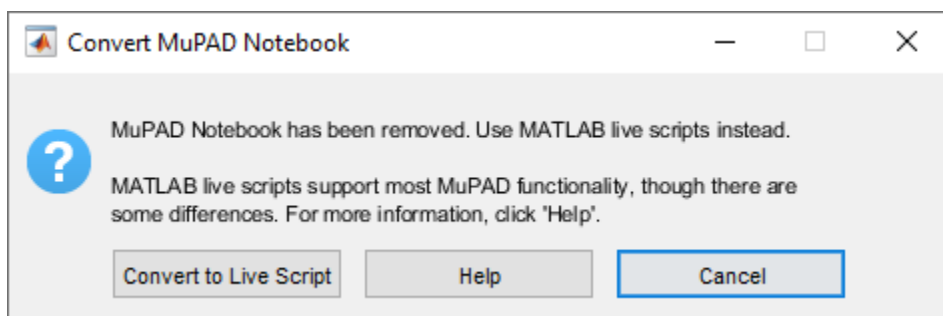

Input Arguments

`filename` — Name of file

character vector

Name of file, specified as a character vector. The extension of `filename` must be `.mn`.

Example: 'C:\MuPAD_Notebooks\myFile.mn'

Compatibility Considerations

mupad has been removed

Errors starting in R2020a

The mupad command errors. MuPAD notebook has been removed. Use MATLAB live scripts instead.

To convert a MuPAD notebook file to a MATLAB live script file, see `convertMuPADNotebook`. MATLAB live scripts support most MuPAD functionality, although there are some differences. For more information, see “Convert MuPAD Notebooks to MATLAB Live Scripts” on page 3-3.

See Also

`convertMuPADNotebook`

Topics

“Convert MuPAD Notebooks to MATLAB Live Scripts” on page 3-3

“Troubleshoot MuPAD to MATLAB Translation Errors” on page 3-8

“Troubleshoot MuPAD to MATLAB Translation Warnings” on page 3-15

Introduced in R2008b

nchoosek

Binomial coefficient

Syntax

```
b = nchoosek(n, k)
C = nchoosek(v, k)
```

Description

`b = nchoosek(n, k)` returns the binomial coefficient of n and k , defined as $n!/(k!(n - k)!)$. This is the number of combinations of n items taken k at a time.

`C = nchoosek(v, k)` returns a matrix containing all possible combinations of the elements of vector v taken k at a time. Matrix C has k columns and $n!/(k!(n - k)!)$ rows, where n is `length(v)`. In this syntax, k must be a nonnegative integer.

Examples

Binomial Coefficients for Numeric and Symbolic Arguments

Compute the binomial coefficients for these expressions.

```
syms n
[nchoosek(n, n), nchoosek(n, n + 1), nchoosek(n, n - 1)]

ans =
[ 1, 0, n]
```

If one or both parameters are negative numbers, convert these numbers to symbolic objects.

```
[nchoosek(sym(-1), 3), nchoosek(sym(-7), 2), nchoosek(sym(-5), -5)]

ans =
[ -1, 28, 1]
```

If one or both parameters are complex numbers, convert these numbers to symbolic objects.

```
[nchoosek(sym(i), 3), nchoosek(sym(i), i), nchoosek(sym(i), i + 1)]

ans =
[ 1/2 + 1i/6, 1, 0]
```

Handle Expressions Containing Binomial Coefficients

Many functions, such as `diff` and `expand`, can handle expressions containing `nchoosek`.

Differentiate the binomial coefficient.

```
syms n k
diff(nchoosek(n, 2))
```

```
ans =  
-(psi(n - 1) - psi(n + 1))*nchoosek(n, 2)
```

Expand the binomial coefficient.

```
expand(nchoosek(n, k))
```

```
ans =  
-(n*gamma(n))/(k^2*gamma(k)*gamma(n - k) - k*n*gamma(k)*gamma(n - k))
```

Pascal Triangle

Use `nchoosek` to build the Pascal triangle.

```
m = 5;  
for n = 0:m  
    C = sym([]);  
    for k = 0:n  
        C = horzcat(C, nchoosek(n, k));  
    end  
    disp(C)  
end
```

```
1  
[ 1, 1]  
[ 1, 2, 1]  
[ 1, 3, 3, 1]  
[ 1, 4, 6, 4, 1]  
[ 1, 5, 10, 10, 5, 1]
```

All Combinations of Vector Elements

Find all combinations of elements of a 1-by-5 symbolic row vector taken three and four at a time.

Create a 1-by-5 symbolic vector with the elements `x1`, `x2`, `x3`, `x4`, and `x5`.

```
v = sym('x', [1, 5])
```

```
v =  
[ x1, x2, x3, x4, x5]
```

Find all combinations of the elements of `v` taken three at a time.

```
C = nchoosek(v, 3)
```

```
C =  
[ x1, x2, x3]  
[ x1, x2, x4]  
[ x1, x3, x4]  
[ x2, x3, x4]  
[ x1, x2, x5]  
[ x1, x3, x5]  
[ x2, x3, x5]  
[ x1, x4, x5]  
[ x2, x4, x5]  
[ x3, x4, x5]
```

```
C = nchoosek(v, 4)
```

```

C =
[ x1, x2, x3, x4]
[ x1, x2, x3, x5]
[ x1, x2, x4, x5]
[ x1, x3, x4, x5]
[ x2, x3, x4, x5]

```

Input Arguments

n — Number of possible choices

symbolic number | symbolic variable | symbolic expression | symbolic function

Number of possible choices, specified as a symbolic number, variable, expression, or function.

k — Number of selected choices

symbolic number | symbolic variable | symbolic expression | symbolic function

Number of selected choices, specified as a symbolic number, variable, expression, or function. If the first argument is a symbolic vector v , then k must be a nonnegative integer.

v — Set of all choices

symbolic vector

Set of all choices, specified as a vector of symbolic numbers, variables, expressions, or functions.

Output Arguments

b — Binomial coefficient

nonnegative scalar value

Binomial coefficient, returned as a nonnegative scalar value.

C — All combinations of v

matrix

All combinations of v , returned as a matrix of the same type as v .

More About

Binomial Coefficient

If n and k are integers and $0 \leq k \leq n$, the binomial coefficient is defined as:

$$\binom{n}{k} = \frac{n!}{k!(n-k)!}$$

For complex numbers, the binomial coefficient is defined via the gamma function:

$$\binom{n}{k} = \frac{\Gamma(n+1)}{\Gamma(k+1)\Gamma(n-k+1)}$$

Tips

- Calling `nchoosek` for numbers that are not symbolic objects invokes the MATLAB `nchoosek` function.
- If one or both parameters are complex or negative numbers, convert these numbers to symbolic objects using `sym`, and then call `nchoosek` for those symbolic objects.

Algorithms

If $k < 0$ or $n - k < 0$, `nchoosek(n, k)` returns 0.

If one or both arguments are complex, `nchoosek` uses the formula representing the binomial coefficient via the `gamma` function.

See Also

`beta` | `factorial` | `gamma` | `psi`

Introduced in R2012a

ne

Define inequality

Syntax

```
A ~= B
ne(A,B)
```

Description

$A \neq B$ creates a symbolic inequality.

`ne(A,B)` is equivalent to $A \neq B$.

Examples

Set and Use Assumption Using Not Equal

Use `assume` and the relational operator `~=` to set the assumption that x does not equal to 5:

```
syms x
assume(x ~= 5)
```

Solve this equation. The solver takes into account the assumption on variable x , and therefore returns only one solution.

```
solve((x - 5)*(x - 6) == 0, x)

ans =
6
```

Input Arguments

A — Input

number | vector | matrix | array | symbolic number | symbolic variable | symbolic array | symbolic function | symbolic expression

Input, specified as a number, vector, matrix, or array, or a symbolic number, variable, array, function, or expression.

B — Input

number | vector | matrix | array | symbolic number | symbolic variable | symbolic array | symbolic function | symbolic expression

Input, specified as a number, vector, matrix, or array, or a symbolic number, variable, array, function, or expression.

Tips

- Calling `~=` or `ne` for non-symbolic `A` and `B` invokes the MATLAB `ne` function. This function returns a logical array with elements set to logical 1 (`true`) where `A` is not equal to `B`; otherwise, it returns logical 0 (`false`).
- If both `A` and `B` are arrays, then these arrays must have the same dimensions. `A ~= B` returns an array of inequalities `A(i,j,...) ~= B(i,j,...)`
- If one input is scalar and the other an array, then the scalar input is expanded into an array of the same dimensions as the other array. In other words, if `A` is a variable (for example, `x`), and `B` is an m -by- n matrix, then `A` is expanded into m -by- n matrix of elements, each set to `x`.

Alternatives

You can also define inequality using `eq` (or its shortcut `==`) and the logical negation `not` (or `~`). Thus, `A ~= B` is equivalent to `~(A == B)`.

See Also

`eq` | `ge` | `gt` | `isAlways` | `le` | `lt`

Topics

“Set Assumptions” on page 1-24

Introduced in R2012a

newUnit

Define new unit

Syntax

```
c = newUnit(name,definition)
```

Description

`c = newUnit(name,definition)` defines the new unit name using the expression `definition`. The definition must be in terms of existing symbolic units. You cannot redefine a predefined unit or any of its alternate names.

Examples

Define New Unit and Rewrite Unit

Load the collection of symbolic units by using `symunit`. Find information on the predefined unit `u.c_0` for the speed of light.

```
u = symunit;
unitInfo(u.c_0)
```

```
speed of light in vacuum - a physical unit of velocity.
```

```
Get all units for measuring 'Velocity' by calling unitInfo('Velocity').
```

Show that the exact value of the speed of light in SI is 299792458 metres per second.

```
c = unitConvert(u.c_0,'SI')
```

```
c =
299792458*([m]/[s])
```

Define the new unit `speedOfLightApprox` for the approximate value of the speed of light as $3e8$ meters per second.

```
u = symunit;
c = newUnit('speedOfLightApprox',3e8*u.m/u.s)
```

```
c =
[speedOfLightApprox]
```

Alternatively, you can specify the unit by using `u.speedOfLightApprox`.

Define the equation $E = mc^2$ using the new unit.

```
syms mass
m = mass*u.kg;
E = m*c^2
```

```
E =
mass*[kg]*[speedOfLightApprox]^2
```

Rewrite E in terms of meters per second.

```
E = rewrite(E,u.m/u.s)
```

```
E =  
9000000000000000000*mass*([kg]*[m]^2)/[s]^2)
```

Since the standard unit of energy is the joule, rewrite E in terms of Joule.

```
E = rewrite(E,u.Joule)
```

```
E =  
9000000000000000000*mass*[J]
```

Input Arguments

name — Name of new unit

character vector | string

Name of the new unit, specified as a character vector or string. You cannot redefine a predefined unit or any of its alternate names.

definition — Definition of new unit

symbolic expression of units

Definition of the new unit, specified as a symbolic expression of units. The new unit must be defined in terms of existing symbolic units. For example, `newUnit('workday',8*u.hour)`, where `u = symunit`, defines `workday` as a unit representing 8 hours.

See Also

`checkUnits` | `isUnit` | `removeUnit` | `separateUnits` | `str2symunit` | `symunit` | `symunit2str` | `unitConversionFactor`

Topics

“Units of Measurement Tutorial” on page 2-19

“Unit Conversions and Unit Systems” on page 2-39

“Units and Unit Systems List” on page 2-25

External Websites

The International System of Units (SI)

Introduced in R2017a

newUnitSystem

Define unit system

Syntax

```
newUnitSystem(name,baseUnits)
newUnitSystem(name,baseUnits,derivedUnits)
```

Description

`newUnitSystem(name,baseUnits)` defines a new “Unit System” on page 4-1001 with the name `name` and the base units `baseUnits`. Now, you can convert units into the new unit system by using `rewrite`. By default, available unit systems include SI, CGS, and US. For all unit systems, see “Unit Systems List” on page 2-36.

`newUnitSystem(name,baseUnits,derivedUnits)` additionally specifies the derived units `derivedUnits`.

Examples

Define New Unit System from Existing System

A unit system is a collection of units to express quantities. The easiest way to define a new unit system is to modify a default unit system, such as SI, CGS, or US.

Modify SI to use kilometer for length and hour for time by getting the base units using `baseunits` and modifying them by using `subs`.

```
u = symunit;
SIUnits = baseUnits('SI')

SIUnits =
 [ [kg], [s], [m], [A], [cd], [mol], [K]]

newUnits = subs(SIUnits,[u.m u.s],[u.km u.hr])

newUnits =
 [ [kg], [h], [km], [A], [cd], [mol], [K]]
```

Note Do not define a variable called `baseUnits` because the variable will prevent access to the `baseUnits` function.

Define the new unit system `SI_km_hr` using the new base units.

```
newUnitSystem('SI_km_hr',newUnits)

ans =
 "SI_km_hr"
```

Rewrite 5 meter/second to the SI_km_hr unit system. As expected, the result is in terms of kilometers and hours.

```
rewrite(5*u.m/u.s, 'SI_km_hr')  
  
ans =  
18*([km]/[h])
```

Specify Base and Derived Units Directly

Specify a new unit system by specifying the base and derived units directly. A unit system has up to 7 base units. For details, see “Unit System” on page 4-1001.

Define a new unit system with these base units: gram, hour, meter, ampere, candela, mol, and celsius. Specify these derived units: kilowatt, newton, and volt.

```
u = symunit;  
sysName = 'myUnitSystem';  
bunits = [u.g u.hr u.m u.A u.cd u.mol u.Celsius];  
dunits = [u.kW u.N u.V];  
newUnitSystem(sysName, bunits, dunits)  
  
ans =  
"myUnitSystem"
```

Rewrite 2000 Watts to the new system. By default, `rewrite` uses base units, which can be hard to read.

```
rewrite(2000*u.W, sysName)  
  
ans =  
933120000000000000*([g]*[m]^2)/[h]^3)
```

Instead, for readability, rewrite 2000 Watts to *derived* units of `myUnitSystem` by specifying 'Derived' as the third argument. Converting to the derived units of a unit system attempts to select convenient units. The result uses the derived unit, kilowatt, instead of base units. For more information, see “Unit Conversions and Unit Systems” on page 2-39.

```
rewrite(2000*u.W, sysName, 'Derived')  
  
ans =  
2*[kW]
```

Input Arguments

name — Name of unit system

string | character vector

Name of unit system, specified as a string or character vector.

baseUnits — Base units of unit system

vector of symbolic units

Base units of unit system, specified as a vector of symbolic units. The base units must be independent in terms of the dimensions mass, time, length, electric current, luminous intensity, amount of substance, and temperature. Thus, in a unit system, there are up to 7 base units.

derivedUnits – Derived units of unit system

vector of symbolic units

Derived units of unit system, specified as a vector of symbolic units. Derived units are optional and added for convenience of representation.

More About

Unit System

A unit system is a collection of base units and derived units that follows these rules:

- Base units must be independent in terms of the dimensions mass, time, length, electric current, luminous intensity, amount of substance, and temperature. Therefore, a unit system has up to 7 base units. As long as the independence is satisfied, any unit can be a base unit, including units such as newton or watt.
- A unit system can have less than 7 base units. For example, mechanical systems need base units only for the dimensions length, mass, and time.
- Derived units in a unit system must have a representation in terms of the products of powers of the base units for that system. Unlike base units, derived units do not have to be independent.
- Derived units are optional and added for convenience of representation. For example, kg m/s^2 is abbreviated by newton.
- An example of a unit system is the SI unit system, which has 7 base units: kilogram, second, meter, ampere, candela, mol, and kelvin. There are 22 derived units found by calling `derivedUnits('SI')`.

See Also

`baseUnits` | `derivedUnits` | `newUnit` | `removeUnitSystem` | `rewrite` | `symunit` | `unitSystems`

Topics

“Units of Measurement Tutorial” on page 2-19

“Unit Conversions and Unit Systems” on page 2-39

“Units and Unit Systems List” on page 2-25

External Websites

The International System of Units (SI)

Introduced in R2017b

nextprime

Next prime number

Syntax

```
nextprime(n)
```

Description

`nextprime(n)` returns the next prime number greater than or equal to n . If n is a vector or matrix, then `nextprime` acts element-wise on n .

Examples

Find Next Prime Number

Find the next prime number greater than 100.

```
nextprime(100)
```

```
ans =  
101
```

Find the next prime numbers greater than 1000, 10000, and 100000 by specifying the input as a vector.

```
v = [1000 10000 100000];  
nextprime(v)
```

```
ans =  
    1009    10007    100003
```

Find Large Prime Number

When finding large prime numbers, return exact symbolic integers by using symbolic input. Further, if your input has 15 or more digits, then use quotation marks and wrap the number in `sym` to represent the number accurately. For more information, see “Numeric to Symbolic Conversion” on page 2-136.

Find a large prime number by using `10sym(18)`.

```
nextprime(10sym(18))
```

```
ans =  
1000000000000000003
```

Find the next prime number to 823572345728582545 by using quotation marks.

```
nextprime(sym('823572345728582545'))
```

```
ans =  
823572345728582623
```

Input Arguments

n — Input

number | vector | matrix | array | symbolic number | symbolic array

Input, specified as a number, vector, matrix, array, or a symbolic number or array.

See Also

isprime | nthprime | prevprime | primes

Introduced in R2016b

norm

Norm of matrix or vector

Syntax

```
norm(A)
norm(A,p)
norm(V)
norm(V,P)
```

Description

`norm(A)` returns the 2-norm of matrix A. Because symbolic variables are assumed to be complex by default, the norm can contain unresolved calls to `conj` and `abs`.

`norm(A,p)` returns the p-norm of matrix A.

`norm(V)` returns the 2-norm of vector V.

`norm(V,P)` returns the P-norm of vector V.

Examples

Compute 2-Norm of Matrix

Compute the 2-norm of the inverse of the 3-by-3 magic square A:

```
A = inv(sym(magic(3)))
norm2 = norm(A)
```

```
A =
[ 53/360, -13/90, 23/360]
[ -11/180, 1/45, 19/180]
[ -7/360, 17/90, -37/360]
```

```
norm2 =
3^(1/2)/6
```

Use `vpa` to approximate the result with 20-digit accuracy:

```
vpa(norm2, 20)
```

```
ans =
0.28867513459481288225
```

Effect of Assumptions on Norm

Compute the norm of $[x \ y]$ and simplify the result. Because symbolic variables are assumed to be complex by default, the calls to `abs` do not simplify.

```
syms x y
simplify(norm([x y]))

ans =
(abs(x)^2 + abs(y)^2)^(1/2)
```

Assume x and y are real, and repeat the calculation. Now, the result is simplified.

```
assume([x y], 'real')
simplify(norm([x y]))

ans =
(x^2 + y^2)^(1/2)
```

Remove assumptions on x for further calculations. For details, see “Use Assumptions on Symbolic Variables” on page 1-24.

```
assume(x, 'clear')
```

Compute Different Types of Norms of Matrix

Compute the 1-norm, Frobenius norm, and infinity norm of the inverse of the 3-by-3 magic square A :

```
A = inv(sym(magic(3)))
norm1 = norm(A, 1)
normf = norm(A, 'fro')
normi = norm(A, inf)

A =
[ 53/360, -13/90, 23/360]
[ -11/180, 1/45, 19/180]
[ -7/360, 17/90, -37/360]
```

```
norm1 =
16/45
```

```
normf =
391^(1/2)/60
```

```
normi =
16/45
```

Use `vpa` to approximate these results to 20-digit accuracy:

```
vpa(norm1, 20)
vpa(normf, 20)
vpa(normi, 20)

ans =
0.35555555555555555556

ans =
0.32956199888808647519

ans =
0.35555555555555555556
```

Compute Different Types of Norms of Vector

Compute the 1-norm, 2-norm, and 3-norm of the column vector $V = [V_x; V_y; V_z]$:

```
syms Vx Vy Vz
V = [Vx; Vy; Vz];
norm1 = norm(V, 1)
norm2 = norm(V)
norm3 = norm(V, 3)

norm1 =
abs(Vx) + abs(Vy) + abs(Vz)

norm2 =
(abs(Vx)^2 + abs(Vy)^2 + abs(Vz)^2)^(1/2)

norm3 =
(abs(Vx)^3 + abs(Vy)^3 + abs(Vz)^3)^(1/3)
```

Compute the infinity norm, negative infinity norm, and Frobenius norm of V :

```
normi = norm(V, inf)
normni = norm(V, -inf)
normf = norm(V, 'fro')

normi =
max(abs(Vx), abs(Vy), abs(Vz))

normni =
min(abs(Vx), abs(Vy), abs(Vz))

normf =
(abs(Vx)^2 + abs(Vy)^2 + abs(Vz)^2)^(1/2)
```

Input Arguments

A — Input

symbolic matrix

Input, specified as a symbolic matrix.

p — Input

2 (default) | 1 | inf | 'fro'

One of these values 1, 2, inf, or 'fro'.

- `norm(A, 1)` returns the 1-norm of A.
- `norm(A, 2)` or `norm(A)` returns the 2-norm of A.
- `norm(A, inf)` returns the infinity norm of A.
- `norm(A, 'fro')` returns the Frobenius norm of A.

V — Input

symbolic vector

Input, specified as a symbolic vector.

P – Input

2 (default) | 1 | inf | 'fro'

- $\text{norm}(V, P)$ is computed as $\text{sum}(\text{abs}(V).^P)^{(1/P)}$ for $1 \leq P < \text{inf}$.
- $\text{norm}(V)$ computes the 2-norm of V .
- $\text{norm}(A, \text{inf})$ is computed as $\max(\text{abs}(V))$.
- $\text{norm}(A, -\text{inf})$ is computed as $\min(\text{abs}(V))$.

More About**1-Norm of a Matrix**

The 1-norm of an m -by- n matrix A is defined as follows:

$$\|A\|_1 = \max_j \left(\sum_{i=1}^m |A_{ij}| \right), \text{ where } j = 1 \dots n$$

2-Norm of a Matrix

The 2-norm of an m -by- n matrix A is defined as follows:

$$\|A\|_2 = \sqrt{\max \text{eigenvalue of } A^H A}$$

The 2-norm is also called the spectral norm of a matrix.

Frobenius Norm of a Matrix

The Frobenius norm of an m -by- n matrix A is defined as follows:

$$\|A\|_F = \sqrt{\sum_{i=1}^m \left(\sum_{j=1}^n |A_{ij}|^2 \right)}$$

Infinity Norm of a Matrix

The infinity norm of an m -by- n matrix A is defined as follows:

$$\|A\|_\infty = \max \left(\sum_{j=1}^n |A_{1j}|, \sum_{j=1}^n |A_{2j}|, \dots, \sum_{j=1}^n |A_{mj}| \right)$$

P-Norm of a Vector

The P-norm of a 1-by- n or n -by-1 vector V is defined as follows:

$$\|V\|_P = \left(\sum_{i=1}^n |V_i|^P \right)^{1/P}$$

Here n must be an integer greater than 1.

Frobenius Norm of a Vector

The Frobenius norm of a 1-by- n or n -by-1 vector V is defined as follows:

$$\|V\|_F = \sqrt{\sum_{i=1}^n |V_i|^2}$$

The Frobenius norm of a vector coincides with its 2-norm.

Infinity and Negative Infinity Norm of a Vector

The infinity norm of a 1-by- n or n -by-1 vector V is defined as follows:

$$\|V\|_\infty = \max(|V_i|), \text{ where } i = 1 \dots n$$

The negative infinity norm of a 1-by- n or n -by-1 vector V is defined as follows:

$$\|V\|_{-\infty} = \min(|V_i|), \text{ where } i = 1 \dots n$$

Tips

- Calling `norm` for a numeric matrix that is not a symbolic object invokes the MATLAB `norm` function.

See Also

`cond` | `equationsToMatrix` | `inv` | `linsolve` | `rank`

Introduced in R2012b

not

Logical NOT for symbolic expressions

Syntax

```
~A
not(A)
```

Description

$\sim A$ represents the logical NOT. $\sim A$ is true when A is false and false when A is true.

`not(A)` is equivalent to $\sim A$.

Examples

Set Assumption Using NOT

Create a logical condition by using \sim .

```
syms x y
cond = ~(x > y);
```

Set the assumption represented by the condition using `assume`.

```
assume(cond)
```

Verify that the assumption is set.

```
assumptions
```

```
ans =
~y < x
```

Evaluate Logical Expressions

Specify a range for x by creating a condition using the logical operators \sim and $\&$.

```
syms x
range = abs(x) < 1 & ~(abs(x)<1/3);
```

Return the conditions at 0 and $2/3$ by substituting for x using `subs`. The `subs` function does not evaluate the conditions automatically.

```
x1 = subs(range,x,0)
x2 = subs(range,x,2/3)
```

```
x1 =
0 < 1 & ~0 < 1/3
x2 =
2/3 < 1 & ~2/3 < 1/3
```

Evaluate the inequalities to logical 1 or 0 by using `isAlways`.

```
isAlways(x1)
isAlways(x2)
```

```
ans =
    logical
     0
```

```
ans =
    logical
     1
```

Input Arguments

A — Input

number | vector | matrix | array | symbolic number | symbolic variable | symbolic array | symbolic function | symbolic expression

Input, specified as a number, vector, matrix, or array, or a symbolic number, variable, array, function, or expression.

Tips

- If you call `simplify` for a logical expression containing symbolic subexpressions, you can get the symbolic constants `symtrue` and `symfalse`. These two constants are not the same as logical 1 (`true`) and logical 0 (`false`). To convert symbolic `symtrue` and `symfalse` to logical values, use `logical`.

See Also

`all` | `and` | `any` | `isAlways` | `or` | `piecewise` | `xor`

Introduced in R2012a

nthprime

nth prime number

Syntax

```
nthprime(n)
```

Description

`nthprime(n)` returns the `n`th prime number. `nthprime` acts element-wise on array inputs.

Examples

Find Nth Prime Number

Find the 223rd prime number.

```
nthprime(223)
```

```
ans =  
    1409
```

For large prime numbers, return exact symbolic integers by using symbolic input.

```
n = sym(223222222);  
nthprime(n)
```

```
ans =  
4738278383
```

Find the 10th, 100th, and 1000th prime numbers.

```
n = [10 100 1000];  
nthprime(n)
```

```
ans =  
    29    541   7919
```

Generate Random Prime Number

Generate a random prime number between the 100,000th and 200,000th prime numbers.

```
rng default % for reproducibility  
range = [100000 200000];  
nthprime(randi(range))
```

```
ans =  
    2476423
```

Input Arguments

n – Input

number | vector | matrix | array | symbolic number | symbolic array

Input, specified as a number, vector, matrix, array, or a symbolic number or array. n must be a positive integer.

See Also

nextprime | prevprime

Introduced in R2018a

nthroot

Nth root of symbolic numbers

Syntax

```
y = nthroot(x,n)
```

Description

`y = nthroot(x,n)` returns the n th root of x with the phase angle closest to the phase of x . The output y has symbolic data type if any input argument is symbolic. The variables satisfy $y.^n = x$.

Examples

Calculate Nth Roots

Calculate the n th root of a negative number.

```
x = sym(-27);
n = -3;
y = nthroot(x,n)
```

```
y =
    -1/3
```

Check that the answer solves the equation $y^n = x$.

```
y^n
ans = -27
```

Calculate the n th root of a complex number.

```
x = sym(1 + 1i);
y = nthroot(x,4)
```

```
y = (1 + i)^{1/4}
```

Find a numeric equivalent of the root.

```
vpa(y)
ans = 1.0695539323639858023756790408254 + 0.2127475047267430357507130792184 i
```

Check that the answer solves the equation $y^n = x$.

```
y^4
ans = 1 + i
```

Calculate the n th roots of an array.

```
x = sym([-27, -8, -4
        27, 64, -12])
```

```
x =
    (-27 -8 -4)
     ( 27 64 -12)
```

```
n = sym([3, 3, 4
        3, 2, -2])
```

```
n =
    (3 3 4)
    (3 2 -2)
```

```
y = nthroot(x, n)
```

```
y =
    (-3 -2 (-1)^(3/4) 4^(1/4))
     ( 3 8 -sqrt(12)/12 i)
```

Check that the answer solves the equation $y^n = x$.

```
y.^n
```

```
ans =
    (-27 -8 -4)
     ( 27 64 -12)
```

Use `nthroot` in further symbolic calculations.

```
syms x
y = solve(nthroot(x, -3) == -3, x)
```

```
y =
    -1/27
```

```
syms x n
y = diff(nthroot(x, n), x)
```

```
y =
    n*sqrt[n]{x}
    n*x
```

Input Arguments

x — Input array for taking root

symbolic array | numeric array

Input array for taking root, specified as a symbolic or numeric array. When taking the root, the function acts element-wise.

If both `x` and `n` are nonscalar arrays, they must have the same size. If any element of `x` or `n` is symbolic and some elements are numeric, `nthroot` converts numeric arguments to symbolic before processing.

Example: `[sym(-8),sym(8);sym(-27),sym(27)]`

n — Input array for order of root

symbolic array | real array

Input array for order of root, specified as a symbolic array or real array.

- If an element of x is not real and positive, meaning it is either negative or has a nonzero imaginary part, then the corresponding element of n must be a nonzero integer.
- If an element of x is real and positive, then the corresponding element of n can have any nonzero real value.

If both x and n are nonscalar arrays, they must have the same size. If any element of x or n are symbolic and some elements are numeric, `nthroot` converts numeric arguments to symbolic before processing.

Example: `sym(-3)`

See Also

`power`

Introduced in R2018b

null

Form basis for null space of matrix

Syntax

```
Z = null(A)
```

Description

`Z = null(A)` returns a list of vectors that form the basis for the null space of a matrix A. The product $A*Z$ is zero. `size(Z, 2)` is the nullity of A. If A has full rank, Z is empty.

Examples

Form Basis for Null Space of Matrix

Find the basis for the null space and the nullity of the magic square of symbolic numbers. Verify that $A*Z$ is zero.

```
A = sym(magic(4));  
Z = null(A)  
nullityOfA = size(Z, 2)  
A*Z
```

```
Z =  
-1  
-3  
3  
1
```

```
nullityOfA =  
1
```

```
ans =  
0  
0  
0  
0
```

Form Basis for Null Space of Matrix of Full Rank

Find the basis for the null space of the matrix B that has full rank.

```
B = sym(hilb(3))  
Z = null(B)
```

```
B =  
[ 1, 1/2, 1/3]  
[ 1/2, 1/3, 1/4]  
[ 1/3, 1/4, 1/5]
```

Z =
Empty sym: 1-by-0

Input Arguments

A — Input

numeric matrix | symbolic matrix

Input, specified as a numeric or symbolic matrix.

See Also

rank | rref | svd

Introduced before R2006a

numden

Extract numerator and denominator

Syntax

```
[N,D] = numden(A)
```

Description

`[N,D] = numden(A)` converts A to a rational form where the numerator and denominator are relatively prime polynomials with integer coefficients. The function returns the numerator and denominator of the rational form of an expression.

If A is a symbolic or a numeric matrix, then N is the symbolic matrix of numerators, and D is the symbolic matrix of denominators. Both N and D are matrices of the same size as A .

Examples

Numerators and Denominators of Symbolic Numbers

Find the numerator and denominator of a symbolic number.

```
[n, d] = numden(sym(4/5))
```

```
n =  
4
```

```
d =  
5
```

Numerators and Denominators of Symbolic Expressions

Find the numerator and denominator of the symbolic expression.

```
syms x y  
[n,d] = numden(x/y + y/x)
```

```
n =  
x^2 + y^2
```

```
d =  
x*y
```

Numerators and Denominators of Matrix Elements

Find the numerator and denominator of each element of a symbolic matrix.

```
syms a b  
[n,d] = numden([a/b, 1/b; 1/a, 1/(a*b)])
```

```
n =  
[ a, 1]  
[ 1, 1]
```



```
d =  
[ b,  b]  
[ a, a*b]
```

Input Arguments

A — Input

symbolic number | symbolic expression | symbolic function | symbolic vector | symbolic matrix

Input, specified as a symbolic number, expression, function, vector, or matrix.

Output Arguments

N — Numerator

symbolic number | symbolic expression | symbolic function | symbolic vector | symbolic matrix

Numerator, returned as a symbolic number, expression, function, vector, or matrix.

D — Denominator

symbolic number | symbolic expression | symbolic function | symbolic vector | symbolic matrix

Denominator, returned as a symbolic number, expression, function, vector, or matrix.

See Also

[divisors](#) | [partfrac](#) | [simplifyFraction](#)

Topics

“Extract Numerators and Denominators of Rational Expressions” on page 2-115

Introduced before R2006a

odeFunction

Convert symbolic expressions to function handle for ODE solvers

Syntax

```
f = odeFunction(expr,vars)
f = odeFunction(expr,vars,p1,...,pN)
f = odeFunction( ___,Name,Value)
```

Description

`f = odeFunction(expr,vars)` converts a system of symbolic algebraic expressions to a MATLAB function handle. This function handle can be used as input to the numerical MATLAB ODE solvers, except for `ode15i`. The argument `vars` specifies the state variables of the system.

`f = odeFunction(expr,vars,p1,...,pN)` specifies the symbolic parameters of the system as `p1,...,pN`.

`f = odeFunction(___,Name,Value)` uses additional options specified by one or more `Name,Value` pair arguments.

Examples

Create Function Handle for ODE Solvers and Solve DAEs

Convert a system of symbolic differential algebraic equations to a function handle suitable for the MATLAB ODE solvers. Then solve the system by using the `ode15s` solver.

Create the following second-order differential algebraic equation.

```
syms y(t);
eqn = diff(y(t),t,2) == (1-y(t)^2)*diff(y(t),t) - y(t);
```

Use `reduceDifferentialOrder` to rewrite that equation as a system of two first-order differential equations. Here, `vars` is a vector of state variables of the system. The new variable `Dy(t)` represents the first derivative of `y(t)` with respect to `t`.

```
[eqs,vars] = reduceDifferentialOrder(eqn,y(t))
```

```
eqs =
    diff(Dyt(t), t) + y(t) + Dyt(t)*(y(t)^2 - 1)
    Dyt(t) - diff(y(t), t)
```

```
vars =
    y(t)
    Dyt(t)
```

Set initial conditions for `y(t)` and its derivative `Dy(t)` to 2 and 0 respectively.

```
initConditions = [2 0];
```

Find the mass matrix M of the system and the right sides of the equations F .

```
[M,F] = massMatrixForm(eqs,vars)
```

```
M =
[ 0, 1]
[-1, 0]

F =
- y(t) - Dyt(t)*(y(t)^2 - 1)
-Dyt(t)
```

M and F refer to the form $M(t, x(t))\dot{x}(t) = F(t, x(t))$. To simplify further computations, rewrite the system in the form $\dot{x}(t) = f(t, x(t))$.

```
f = M\F
```

```
f =
-Dyt(t)*y(t)^2 - y(t) + Dyt(t)
```

Convert f to a MATLAB function handle by using `odeFunction`. The resulting function handle is input to the MATLAB ODE solver `ode15s`.

```
odefun = odeFunction(f,vars);
ode15s(odefun, [0 10], initConditions)
```

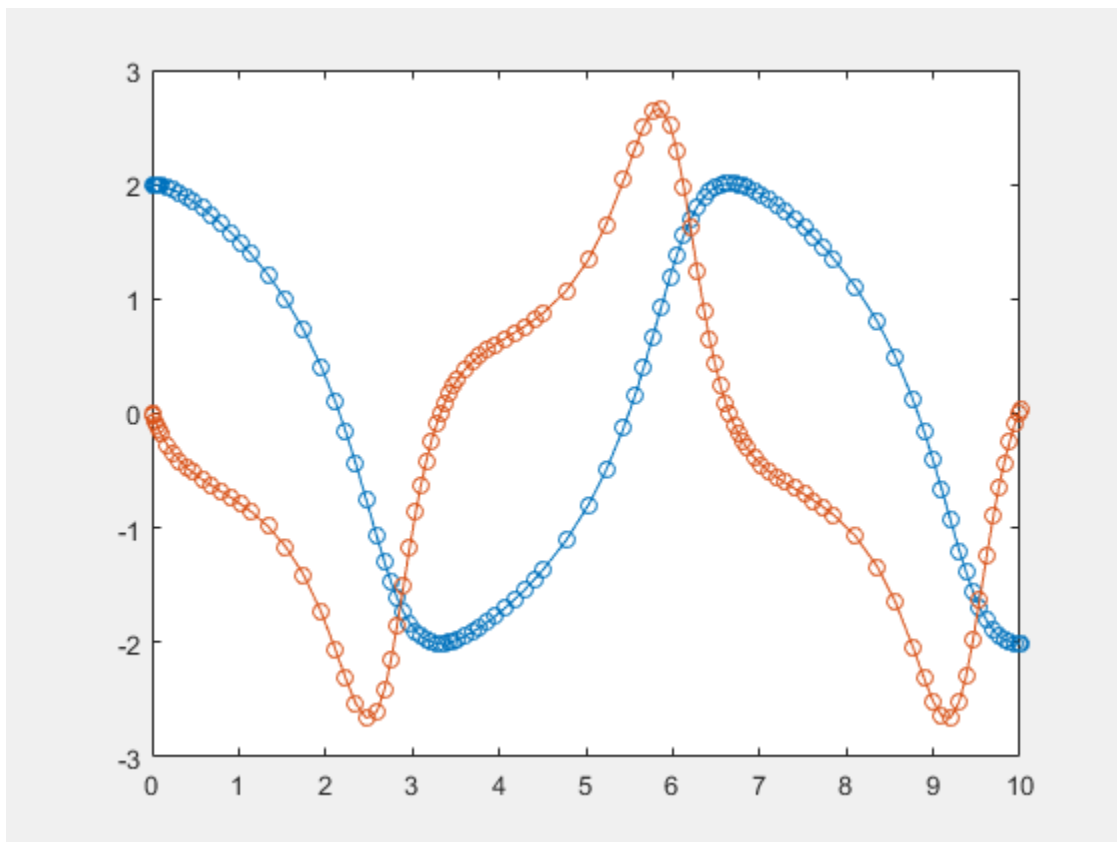

Function Handles for System Containing Symbolic Parameters

Convert a system of symbolic differential equations containing both state variables and symbolic parameters to a function handle suitable for the MATLAB ODE solvers.

Create the system of differential algebraic equations. Here, the symbolic functions $x_1(t)$ and $x_2(t)$ represent the state variables of the system. The system also contains constant symbolic parameters a , b , and the parameter function $r(t)$. These parameters do not represent state variables. Specify the equations and state variables as two symbolic vectors: equations as a vector of symbolic equations, and variables as a vector of symbolic function calls.

```
syms x1(t) x2(t) a b r(t)
eqs = [diff(x1(t),t) == a*x1(t) + b*x2(t)^2,...
       x1(t)^2 + x2(t)^2 == r(t)^2];
vars = [x1(t) x2(t)];
```

Find the mass matrix M and vector of the right side F for this system. M and F refer to the form $M(t, x(t))\dot{x}(t) = F(t, x(t))$.

```
[M, F] = massMatrixForm(eqs, vars)
```

```
M =
[ 1, 0]
[ 0, 0]
```

```
F =
      b*x2(t)^2 + a*x1(t)
r(t)^2 - x1(t)^2 - x2(t)^2
```

Use `odeFunction` to generate MATLAB function handles from M and F . The function handle F contains symbolic parameters.

```
M = odeFunction(M, vars)
F = odeFunction(F, vars, a, b, r(t))
```

```
M =
function_handle with value:
@(t,in2)reshape([1.0,0.0,0.0,0.0],[2,2])
```

```
F =
function_handle with value:
@(t,in2,param1,param2,param3)[param1.*in2(1,)+...
param2.*in2(2,).^2;param3.^2-in2(1,).^2-in2(2,).^2]
```

Specify the parameter values.

```
a = -0.6;
b = -0.1;
r = @(t) cos(t)/(1+t^2);
```

Create the reduced function handle F .

```
F = @(t,Y) F(t,Y,a,b,r(t));
```

Specify consistent initial conditions for the DAE system.

```
t0 = 0;
y0 = [-r(t0)*sin(0.1); r(t0)*cos(0.1)];
yp0 = [a*y0(1) + b*y0(2)^2; 1.234];
```

Create an option set that contains the mass matrix M of the system and vector $yp0$ of initial conditions for the derivatives.

```
opt = odeset('mass',M,'InitialSlope',yp0);
```

Now, use `ode15s` to solve the system of equations.

```
ode15s(F, [t0, 1], y0, opt)
```

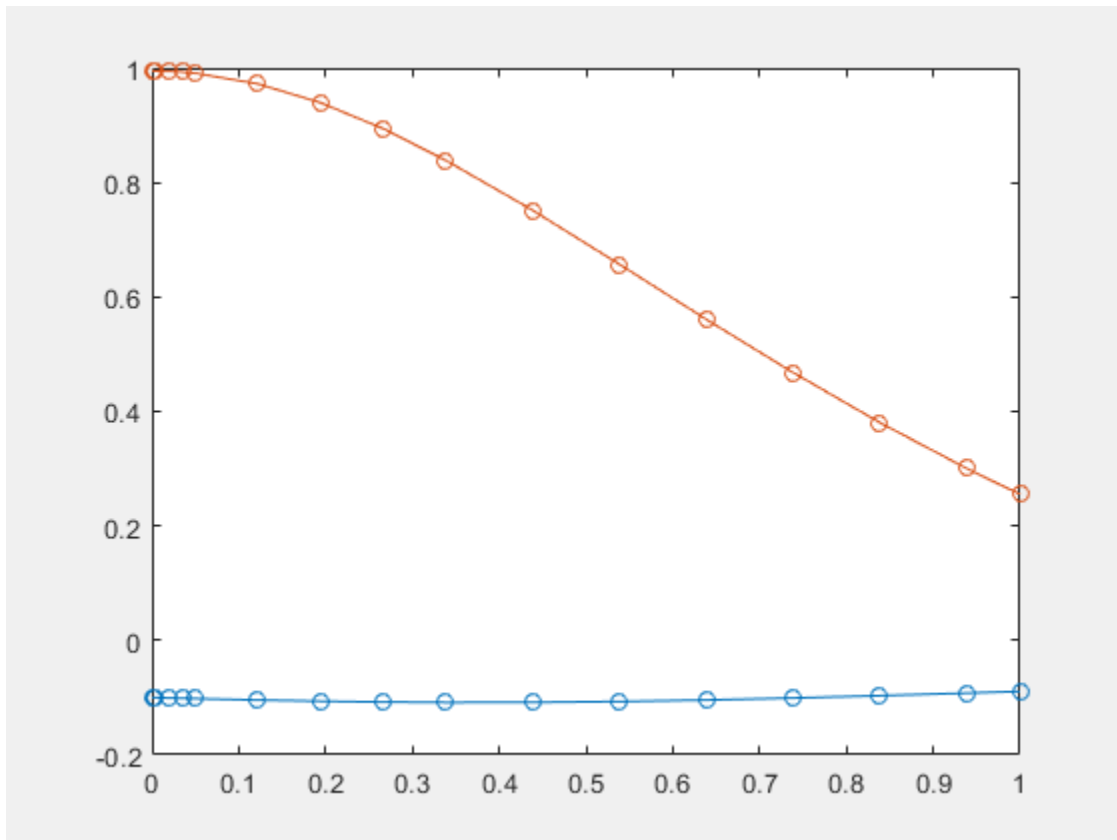

Write Function Handles to File with Comments

Write the generated function handles to files by using the `File` option. When writing to files, `odeFunction` optimizes the code using intermediate variables named `t0`, `t1`, Include comments the files by specifying the `Comments` option.

Define the system of differential equations. Find the mass matrix M and the right side F .

```
syms x(t) y(t)
eqs = [diff(x(t),t)+2*diff(y(t),t) == 0.1*y(t), ...
        x(t)-y(t) == cos(t)-0.2*t*sin(x(t))];
vars = [x(t) y(t)];
[M,F] = massMatrixForm(eqs,vars);
```

Write the MATLAB code for M and F to the files `myfileM` and `myfileF`. `odeFunction` overwrites existing files. Include the comment `Version: 1.1` in the files You can open and edit the output files.

```
M = odeFunction(M,vars,'File','myfileM','Comments','Version: 1.1');  
  
function expr = myfileM(t,in2)  
%MYFILEM  
%   EXPR = MYFILEM(T,IN2)  
  
%   This function was generated by the Symbolic Math Toolbox version 7.3.  
%   01-Jan-2017 00:00:00
```

```
%Version: 1.1  
expr = reshape([1.0,0.0,2.0,0.0],[2, 2]);
```

```
F = odeFunction(F,vars,'File','myfileF','Comments','Version: 1.1');
```

```
function expr = myfileF(t,in2)  
%MYFILEF  
%   EXPR = MYFILEF(T,IN2)  
  
%   This function was generated by the Symbolic Math Toolbox version 7.3.  
%   01-Jan-2017 00:00:00
```

```
%Version: 1.1  
x = in2(1,:);  
y = in2(2,:);  
expr = [y.*(1.0./1.0e1);-x+y+cos(t)-t.*sin(x).*(1.0./5.0)];
```

Specify consistent initial values for $x(t)$ and $y(t)$ and their first derivatives.

```
xy0 = [2; 1];    % x(t) and y(t)  
xyp0 = [0; 0.05*xy0(2)]; % derivatives of x(t) and y(t)
```

Create an option set that contains the mass matrix M , initial conditions $xyp0$, and numerical tolerances for the numerical search.

```
opt = odeset('mass', M, 'RelTol', 10^(-6),...  
            'AbsTol', 10^(-6), 'InitialSlope', xyp0);
```

Solve the system of equations by using `ode15s`.

```
ode15s(F, [0 7], xy0, opt)
```

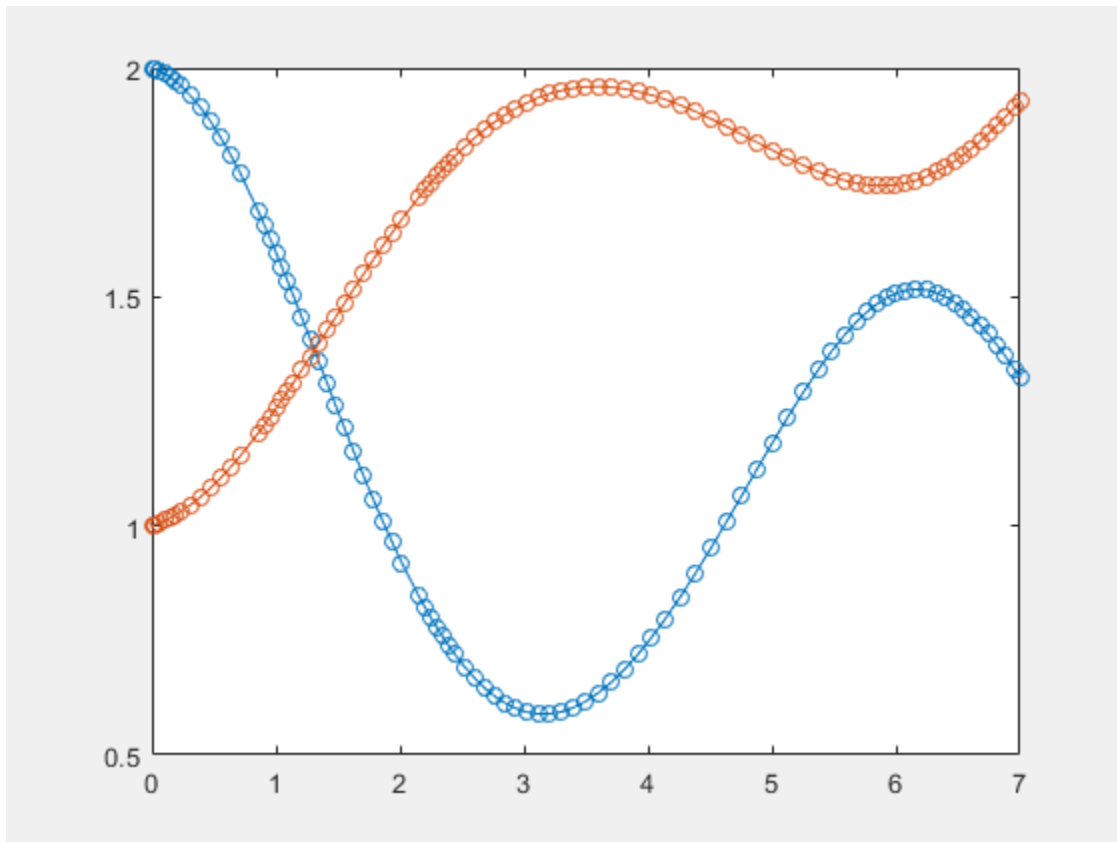

Sparse Matrices

Use the name-value pair argument 'Sparse', true when converting sparse symbolic matrices to MATLAB function handles.

Create the system of differential algebraic equations. Here, the symbolic functions $x_1(t)$ and $x_2(t)$ represent the state variables of the system. Specify the equations and state variables as two symbolic vectors: equations as a vector of symbolic equations, and variables as a vector of symbolic function calls.

```
syms x1(t) x2(t)

a = -0.6;
b = -0.1;
r = @(t) cos(t)/(1 + t^2);

eqs = [diff(x1(t),t) == a*x1(t) + b*x2(t)^2,...
       x1(t)^2 + x2(t)^2 == r(t)^2];
vars = [x1(t) x2(t)];
```

Find the mass matrix M and vector of the right side F for this system. M and F refer to the form $M(t, x(t))\dot{x}(t) = F(t, x(t))$.

```
[M,F] = massMatrixForm(eqs,vars)
```

```
M =  
[ 1, 0]  
[ 0, 0]  
  
F =  
      - (3*x1(t))/5 - x2(t)^2/10  
cos(t)^2/(t^2 + 1)^2 - x1(t)^2 - x2(t)^2
```

Generate MATLAB function handles from M and F . Because most of the elements of the mass matrix M are zeros, use the `Sparse` argument when converting M .

```
M = odeFunction(M,vars,'Sparse',true)  
F = odeFunction(F,vars)
```

```
M =  
function_handle with value:  
  @(t,in2)sparse([1],[1],[1.0],2,2)
```

```
F =  
function_handle with value:  
  @(t,in2)[in2(1,:).*(-3.0./5.0)-in2(2,:).^2./1.0e+1;...  
  cos(t).^2.*1.0./(t.^2+1.0).^2-in2(1,:).^2-in2(2,:).^2]
```

Specify consistent initial conditions for the DAE system.

```
t0 = 0;  
y0 = [-r(t0)*sin(0.1); r(t0)*cos(0.1)];  
yp0= [a*y0(1) + b*y0(2)^2; 1.234];
```

Create an option set that contains the mass matrix M of the system and vector $yp0$ of initial conditions for the derivatives.

```
opt = odeset('mass',M,'InitialSlope', yp0);
```

Solve the system of equations using `ode15s`.

```
ode15s(F, [t0, 1], y0, opt)
```

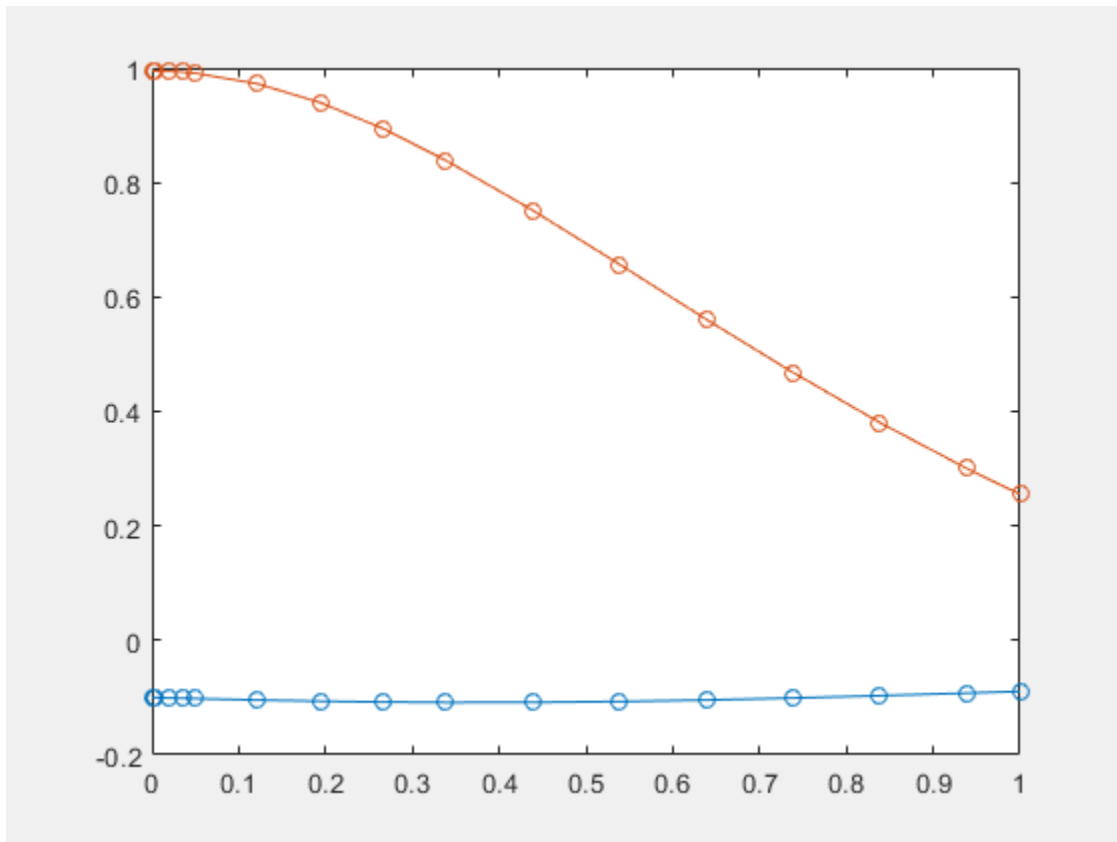
Input Arguments

expr — System of algebraic expressions

vector of symbolic expressions

System of algebraic expressions, specified as a vector of symbolic expressions.

vars — State variables

vector of symbolic functions | vector of symbolic function calls

State variables, specified as a vector of symbolic functions or function calls, such as $x(t)$.

Example: $[x(t), y(t)]$ or $[x(t); y(t)]$

p1, ..., pN — Parameters of system

symbolic variables | symbolic functions | symbolic function calls | symbolic vector | symbolic matrix

Parameters of the system, specified as symbolic variables, functions, or function calls, such as $f(t)$. You can also specify parameters of the system as a vector or matrix of symbolic variables, functions, or function calls. If `expr` contains symbolic parameters other than the variables specified in `vars`, you must specify these additional parameters as $p1, \dots, pN$.

Name-Value Pair Arguments

Specify optional comma-separated pairs of `Name`, `Value` arguments. `Name` is the argument name and `Value` is the corresponding value. `Name` must appear inside quotes. You can specify several name and value pair arguments in any order as `Name1, Value1, . . . , NameN, ValueN`.

Example: `odeFunction(expr, vars, 'File', 'myfile')`

Comments — Comments to include in file header

character vector | cell array of character vectors | string vector

Comments to include in the file header, specified as a character vector, cell array of character vectors, or string vector.

File — Path to file containing generated code

character vector

Path to the file containing generated code, specified as a character vector. The generated file accepts arguments of type `double`, and can be used without Symbolic Math Toolbox. If the value is empty, `odeFunction` generates an anonymous function. If the character vector does not end in `.m`, the function appends `.m`.

By default, `odeFunction` with the `File` argument generates a file containing optimized code. Optimized means intermediate variables are automatically generated to simplify or speed up the code. MATLAB generates intermediate variables as a lowercase letter `t` followed by an automatically generated number, for example `t32`. To disable code optimization, use the `Optimize` argument.

Optimize — Flag preventing optimization of code written to function file

`true` (default) | `false`

Flag preventing optimization of code written to a function file, specified as `false` or `true`.

By default, `odeFunction` with the `File` argument generates a file containing optimized code. Optimized means intermediate variables are automatically generated to simplify or speed up the code. MATLAB generates intermediate variables as a lowercase letter `t` followed by an automatically generated number, for example `t32`.

`odeFunction` without the `File` argument (or with a file path specified by an empty character vector) creates a function handle. In this case, the code is not optimized. If you try to enforce code optimization by setting `Optimize` to `true`, then `odeFunction` throws an error.

Sparse — Flag that switches between sparse and dense matrix generation

`false` (default) | `true`

Flag that switches between sparse and dense matrix generation, specified as `true` or `false`. When you specify `'Sparse'`, `true`, the generated function represents symbolic matrices by sparse numeric matrices. Use `'Sparse'`, `true` when you convert symbolic matrices containing many zero elements. Often, operations on sparse matrices are more efficient than the same operations on dense matrices. See “Sparse Matrices” on page 4-1025.

Output Arguments

f — Function handle that is input to numerical MATLAB ODE solvers, except `ode15i`

MATLAB function handle

Function handle that can serve as input argument to all numerical MATLAB ODE solvers, except for `ode15i`, returned as a MATLAB function handle.

`odeFunction` returns a function handle suitable for the ODE solvers such as `ode45`, `ode15s`, `ode23t`, and others. The only ODE solver that does not accept this function handle is the solver for fully implicit differential equations, `ode15i`. To convert the system of equations to a function handle suitable for `ode15i`, use `daeFunction`.

See Also

[daeFunction](#) | [decic](#) | [findDecoupledBlocks](#) | [incidenceMatrix](#) | [isLowIndexDAE](#) | [massMatrixForm](#) | [matlabFunction](#) | [ode15i](#) | [ode15s](#) | [ode23t](#) | [ode45](#) | [reduceDAEIndex](#) | [reduceDAEToODE](#) | [reduceDifferentialOrder](#) | [reduceRedundancies](#)

Topics

“Solve DAEs Using Mass Matrix Solvers” on page 2-209

Introduced in R2015a

odeToVectorField

Reduce order of differential equations to first-order

Note Support for character vector or string inputs will be removed in a future release. Instead, use syms to declare variables, and replace inputs such as `odeToVectorField('D2y = x')` with `syms y(x)`, `odeToVectorField(diff(y,x,2) == x)`.

Syntax

```
V = odeToVectorField(eqn1,...,eqnN)
[V,S] = odeToVectorField(eqn1,...,eqnN)
```

Description

`V = odeToVectorField(eqn1,...,eqnN)` converts higher-order differential equations `eqn1,...,eqnN` to a system of first-order differential equations, returned as a symbolic vector.

`[V,S] = odeToVectorField(eqn1,...,eqnN)` converts `eqn1,...,eqnN` and returns two symbolic vectors. The first vector `V` is the same as the output of the previous syntax. The second vector `S` shows the substitutions made to obtain `V`.

Examples

Convert Second-Order Differential Equation to First-Order System

Define a second-order differential equation:

$$\frac{d^2y}{dt^2} + y^2t = 3t.$$

Convert the second-order differential equation to a system of first-order differential equations.

```
syms y(t)
eqn = diff(y,2) + y^2*t == 3*t;
V = odeToVectorField(eqn)
```

$$V = \begin{pmatrix} Y_2 \\ 3t - tY_1^2 \end{pmatrix}$$

The elements of `V` represent the system of first-order differential equations, where $V[i] = Y_i'$ and $Y_1 = y$. Here, the output `V` represents these equations:

$$\frac{dY_1}{dt} = Y_2$$

$$\frac{dY_2}{dt} = 3t - tY_1^2.$$

For details on the relation between the input and output, see “Algorithms” on page 4-1033.

Return Substitutions Made When Reducing Order of Differential Equations

When reducing the order of differential equations, return the substitutions that `odeToVectorField` makes by specifying a second output argument.

```
syms f(t) g(t)
eqn1 = diff(g) == g-f;
eqn2 = diff(f,2) == g+f;
eqns = [eqn1 eqn2];
[V,S] = odeToVectorField(eqns)
```

$$V = \begin{pmatrix} Y_2 \\ Y_1 + Y_3 \\ Y_3 - Y_1 \end{pmatrix}$$

$$S = \begin{pmatrix} f \\ Df \\ g \end{pmatrix}$$

The elements of V represent the system of first-order differential equations, where $V[i] = Y_i'$. The output S shows the substitutions being made, $S[1] = Y_1 = f$, $S[2] = Y_2 = \text{diff}(f)$, and $S[3] = Y_3 = g$.

Solve Higher-Order Differential Equation Numerically

Solve a higher-order differential equation numerically by reducing the order of the equation, generating a MATLAB® function handle, and then finding the numerical solution using the `ode45` function.

Convert the following second-order differential equation to a system of first-order differential equations by using `odeToVectorField`.

$$\frac{d^2 y}{dt^2} = (1 - y^2) \frac{dy}{dt} - y.$$

```
syms y(t)
eqn = diff(y,2) == (1-y^2)*diff(y)-y;
V = odeToVectorField(eqn)
```

$$V = \begin{pmatrix} Y_2 \\ -(Y_1^2 - 1)Y_2 - Y_1 \end{pmatrix}$$

Generate a MATLAB function handle from V by using `matlabFunction`.

```
M = matlabFunction(V, 'vars', {'t', 'Y'})
```

```
M = function_handle with value:
    @(t,Y)[Y(2); -(Y(1).^2-1.0).*Y(2)-Y(1)]
```

Specify the solution interval to be $[0 \ 20]$ and the initial conditions to be $y'(0) = 2$ and $y''(0) = 0$. Solve the system of first-order differential equations by using `ode45`.

```
interval = [0 20];
yInit = [2 0];
ySol = ode45(M,interval,yInit);
```

Next, plot the solution $y(t)$ within the interval $t = [0 \ 20]$. Generate the values of t by using `linspace`. Evaluate the solution for $y(t)$, which is the first index in `ySol`, by calling the `deval` function with an index of 1. Plot the solution using `plot`.

```
tValues = linspace(0,20,100);
yValues = deval(ySol,tValues,1);
plot(tValues,yValues)
```

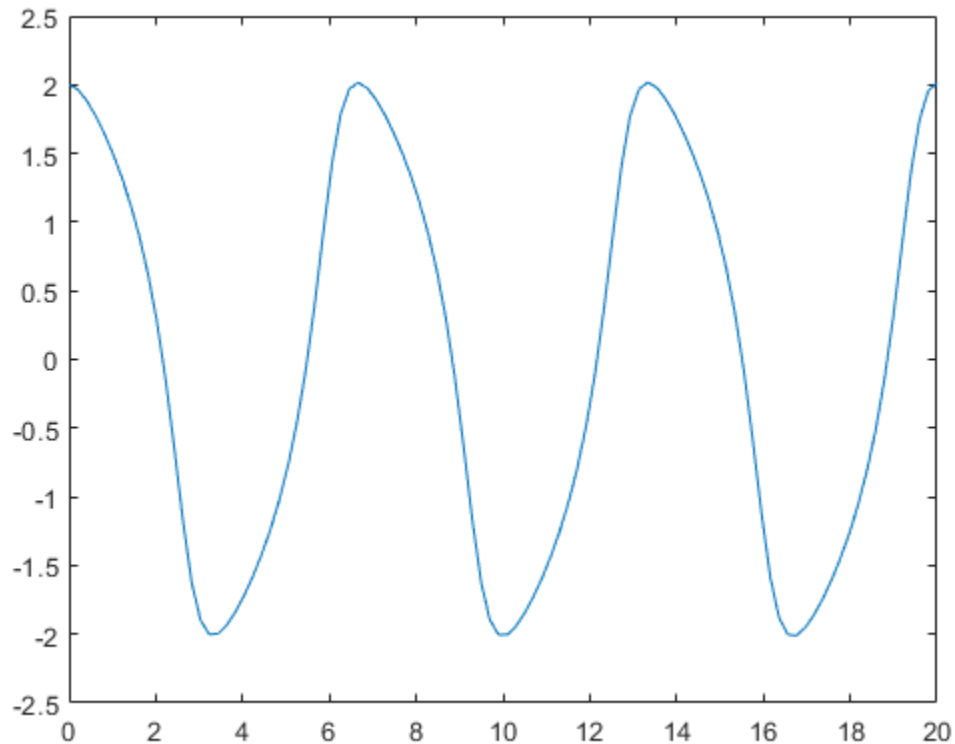

Convert Second-Order Differential Equation with Initial Condition

Convert the second-order differential equation $y''(x) = x$ with the initial condition $y(0) = a$ to a first-order system.

```
syms y(x) a
eqn = diff(y,x,2) == x;
```

```
cond = y(0) == a;
V = odeToVectorField(eqn,cond)
```

```
V =
    ( Y2
      x )
```

Input Arguments

eqn1, . . . , eqnN — Higher-order differential equations

symbolic differential equation | array of symbolic differential equations

Higher-order differential equations, specified as a symbolic differential equation or an array of symbolic differential equations. Use the `==` operator to create an equation. Use the `diff` function to indicate differentiation. For example, represent $d^2y(t)/dt^2 = t y(t)$ by entering the following command.

```
syms y(t)
eqn = diff(y,2) == t*y;
```

Output Arguments

V — First-order differential equations

symbolic expression | vector of symbolic expressions

First-order differential equations, returned as a symbolic expression or a vector of symbolic expressions. Each element of this vector is the right side of the first-order differential equation $Y[i]'$ = $V[i]$.

S — Substitutions in first-order equations

vector of symbolic expressions

Substitutions in first-order equations, returned as a vector of symbolic expressions. The elements of the vector represent the substitutions, such that $S(1) = Y[1]$, $S(2) = Y[2]$,....

Tips

- To solve the resulting system of first-order differential equations, generate a MATLAB function handle using `matlabFunction` with `V` as an input. Then, use the generated MATLAB function handle as an input for the MATLAB numerical solver `ode23` or `ode45`.
- `odeToVectorField` can convert only quasi-linear differential equations. That is, the highest-order derivatives must appear linearly. For example, `odeToVectorField` can convert $y*y''(t) = -t^2$ because it can be rewritten as $y''(t) = -t^2/y$. However, it cannot convert $y''(t)^2 = -t^2$ or $\sin(y''(t)) = -t^2$.

Algorithms

To convert an n th-order differential equation

$$a_n(t)y^{(n)} + a_{n-1}(t)y^{(n-1)} + \dots + a_1(t)y' + a_0(t)y + r(t) = 0$$

into a system of first-order differential equations, `odetovectorfield` makes these substitutions.

$$\begin{aligned}
 Y_1 &= y \\
 Y_2 &= y' \\
 Y_3 &= y'' \\
 &\dots \\
 Y_{n-1} &= y^{(n-2)} \\
 Y_n &= y^{(n-1)}
 \end{aligned}$$

Using the new variables, it rewrites the equation as a system of n first-order differential equations:

$$\begin{aligned}
 Y_1' &= y' = Y_2 \\
 Y_2' &= y'' = Y_3 \\
 &\dots \\
 Y_{n-1}' &= y^{(n-1)} = Y_n \\
 Y_n' &= -\frac{a_{n-1}(t)}{a_n(t)}Y_n - \frac{a_{n-2}(t)}{a_n(t)}Y_{n-1} - \dots - \frac{a_1(t)}{a_n(t)}Y_2 - \frac{a_0(t)}{a_n(t)}Y_1 + \frac{r(t)}{a_n(t)}
 \end{aligned}$$

`odeToVectorField` returns the right sides of these equations as the elements of vector V and the substitutions made as the second output S .

Compatibility Considerations

`odeToVectorField` will no longer support character vector or string inputs

Warns starting in R2019b

`odeToVectorField` will not accept equations as strings or character vectors in a future release. Instead, use symbolic expressions or `sym` objects to define differential equations. For example, replace inputs such as `odeToVectorField('D2y=x')` with `syms y(x)`, `odeToVectorField(diff(y,x,2)==x)`.

See Also

`dsolve` | `matlabFunction` | `ode23` | `ode45`

Introduced in R2012a

or

Logical OR for symbolic expressions

Syntax

```
A | B
or(A,B)
```

Description

$A | B$ represents the logical OR. $A | B$ is true when either A or B is true, or when both A and B are true.

`or(A,B)` is equivalent to $A | B$.

Examples

Set Assumption Using OR

Combine these symbolic inequalities into a logical condition by using `|`.

```
syms x y
xy = x>=0 | y>=0;
```

Set the assumption represented by the condition using `assume`.

```
assume(xy)
```

Verify that the assumptions are set.

```
assumptions
```

```
ans =
0 <= x | 0 <= y
```

Set and Evaluate Condition

Combine two symbolic inequalities into a logical expression by using `|`.

```
range = x < -1 | x > 1;
```

Substitute x with 0 and 10 . Although the inequalities have values, `subs` does not evaluate them to logical `1` or `0`.

```
x1 = subs(range,x,10)
x2 = subs(range,x,0)
```

```
x1 =
1 < 10 | 10 < -1
x2 =
0 < -1 | 1 < 0
```

Evaluate the inequalities by using `isAlways`.

```
isAlways(x1)
```

```
ans =  
    logical  
     1
```

```
isAlways(x2)
```

```
ans =  
    logical  
     0
```

Combine Multiple Conditions

Combine multiple conditions by applying `or` to the conditions using the `fold` function.

Set the condition that `x` equals an integer between 1 and 10.

```
syms x  
cond = fold(@or, x == 1:10);  
assume(cond)  
assumptions  
  
ans =  
x == 1 | x == 2 | x == 3 | x == 4 | x == 5 | ...  
x == 6 | x == 7 | x == 8 | x == 9 | x == 10
```

Input Arguments

A, B — Operands

symbolic equations | symbolic inequalities | symbolic expressions | symbolic arrays

Operands, specified as symbolic equations, inequalities, expressions, or arrays. Inputs **A** and **B** must either be the same size or have sizes that are compatible (for example, **A** is an **M**-by-**N** matrix and **B** is a scalar or 1-by-**N** row vector). For more information, see “Compatible Array Sizes for Basic Operations” (MATLAB).

Tips

- If you call `simplify` for a logical expression containing symbolic subexpressions, you can get the symbolic constants `symtrue` and `symfalse`. These two constants are not the same as logical `1` (`true`) and logical `0` (`false`). To convert symbolic `symtrue` and `symfalse` to logical values, use `logical`.

Compatibility Considerations

Implicit expansion change affects arguments for operators

Behavior changed in R2016b

Starting in R2016b with the addition of implicit expansion, some combinations of arguments for basic operations that previously returned errors now produce results. For example, you previously could

not add a row and a column vector, but those operands are now valid for addition. In other words, an expression like `[1 2] + [1; 2]` previously returned a size mismatch error, but now it executes.

If your code uses element-wise operators and relies on the errors that MATLAB previously returned for mismatched sizes, particularly within a `try/catch` block, then your code might no longer catch those errors.

For more information on the required input sizes for basic array operations, see “Compatible Array Sizes for Basic Operations” (MATLAB).

See Also

`all` | `and` | `any` | `isAlways` | `not` | `piecewise` | `xor`

Introduced in R2012a

orth

Orthonormal basis for range of symbolic matrix

Syntax

```
orth(A)
orth(A,'real')
orth(A,'skipnormalization')
orth(A,'real','skipnormalization')
```

Description

`orth(A)` computes an orthonormal basis on page 4-1040 for the range of `A`.

`orth(A,'real')` computes an orthonormal basis using a real scalar product in the orthogonalization process.

`orth(A,'skipnormalization')` computes a non-normalized orthogonal basis. In this case, the vectors forming the columns of `B` do not necessarily have length 1.

`orth(A,'real','skipnormalization')` computes a non-normalized orthogonal basis using a real scalar product in the orthogonalization process.

Examples

Compute Orthonormal Basis

Compute an orthonormal basis of the range of this matrix. Because these numbers are not symbolic objects, you get floating-point results.

```
A = [2 -3 -1; 1 1 -1; 0 1 -1];
B = orth(A)
```

```
B =
   -0.9859   -0.1195    0.1168
    0.0290   -0.8108   -0.5846
    0.1646   -0.5729    0.8029
```

Now, convert this matrix to a symbolic object, and compute an orthonormal basis:

```
A = sym([2 -3 -1; 1 1 -1; 0 1 -1]);
B = orth(A)
```

```
B =
[ (2*5^(1/2))/5, -6^(1/2)/6, -(2^(1/2)*15^(1/2))/30]
[ 5^(1/2)/5, 6^(1/2)/3, (2^(1/2)*15^(1/2))/15]
[ 0, 6^(1/2)/6, -(2^(1/2)*15^(1/2))/6]
```

You can use `double` to convert this result to the double-precision numeric form. The resulting matrix differs from the matrix returned by the MATLAB `orth` function because these functions use different versions of the Gram-Schmidt orthogonalization algorithm:

```
double(B)

ans =
    0.8944    -0.4082    -0.1826
    0.4472     0.8165     0.3651
         0     0.4082    -0.9129
```

Verify that $B' * B = I$, where I is the identity matrix:

```
B'*B

ans =
[ 1, 0, 0]
[ 0, 1, 0]
[ 0, 0, 1]
```

Now, verify that the 2-norm of each column of B is 1:

```
norm(B(:, 1))
norm(B(:, 2))
norm(B(:, 3))
```

```
ans =
1
```

```
ans =
1
```

```
ans =
1
```

Compute Real Orthonormal Basis

Compute an orthonormal basis of this matrix using 'real' to avoid complex conjugates:

```
syms a
A = [a 1; 1 a];
B = orth(A, 'real')

B =
[ a/(a^2 + 1)^(1/2),      -(a^2 - 1)/((a^2 + 1)*((a^2 - ...
  1)^2/(a^2 + 1)^2 + (a^2*(a^2 - 1)^2)/(a^2 + 1)^2)^(1/2))]
[ 1/(a^2 + 1)^(1/2), (a*(a^2 - 1))/((a^2 + 1)*((a^2 - ...
  1)^2/(a^2 + 1)^2 + (a^2*(a^2 - 1)^2)/(a^2 + 1)^2)^(1/2)]]
```

Compute Orthogonal Basis by Skipping Normalization

Compute an orthogonal basis of this matrix using 'skipnormalization'. The lengths of the resulting vectors (the columns of matrix B) are not required to be 1

```
syms a
A = [a 1; 1 a];
B = orth(A, 'skipnormalization')

B =
[ a,      -(a^2 - 1)/(a*conj(a) + 1)]
[ 1, -(conj(a) - a^2*conj(a))/(a*conj(a) + 1)]
```

Compute Real Orthogonal Basis

Compute an orthogonal basis of this matrix using 'skipnormalization' and 'real':

```
syms a
A = [a 1; 1 a];
B = orth(A,'skipnormalization','real')

B =
[ a,      -(a^2 - 1)/(a^2 + 1)]
[ 1, (a*(a^2 - 1))/(a^2 + 1)]
```

Input Arguments

A — Input

symbolic matrix

Input, specified as a symbolic matrix.

More About

Orthonormal Basis

An orthonormal basis for the range of matrix A is matrix B, such that:

- $B' * B = I$, where I is the identity matrix.
- The columns of B span the same space as the columns of A.
- The number of columns of B is the rank of A.

Tips

- Calling `orth` for numeric arguments that are not symbolic objects invokes the MATLAB `orth` function. Results returned by MATLAB `orth` can differ from results returned by `orth` because these two functions use different algorithms to compute an orthonormal basis. The Symbolic Math Toolbox `orth` function uses the classic Gram-Schmidt orthogonalization algorithm. The MATLAB `orth` function uses the modified Gram-Schmidt algorithm because the classic algorithm is numerically unstable.
- Using 'skipnormalization' to compute an orthogonal basis instead of an orthonormal basis can speed up your computations.

Algorithms

`orth` uses the classic Gram-Schmidt orthogonalization algorithm.

See Also

`norm` | `null` | `orth` | `rank` | `svd`

Introduced in R2013a

pade

Pade approximant

Syntax

```
pade(f, var)
pade(f, var, a)
pade( ____, Name, Value)
```

Description

`pade(f, var)` returns the third-order Padé approximant of the expression `f` at `var = 0`. For details, see “Padé Approximant” on page 4-1045.

If you do not specify `var`, then `pade` uses the default variable determined by `symvar(f, 1)`.

`pade(f, var, a)` returns the third-order Padé approximant of expression `f` at the point `var = a`.

`pade(____, Name, Value)` uses additional options specified by one or more `Name, Value` pair arguments. You can specify `Name, Value` after the input arguments in any of the previous syntaxes.

Examples

Find Padé Approximant for Symbolic Expressions

Find the Padé approximant of $\sin(x)$. By default, `pade` returns a third-order Padé approximant.

```
syms x
pade(sin(x))

ans =
-(x*(7*x^2 - 60))/(3*(x^2 + 20))
```

Specify Expansion Variable

If you do not specify the expansion variable, `symvar` selects it. Find the Padé approximant of $\sin(x) + \cos(y)$. The `symvar` function chooses `x` as the expansion variable.

```
syms x y
pade(sin(x) + cos(y))

ans =
(- 7*x^3 + 3*cos(y)*x^2 + 60*x + 60*cos(y))/(3*(x^2 + 20))
```

Specify the expansion variable as `y`. The `pade` function returns the Padé approximant with respect to `y`.

```
pade(sin(x) + cos(y), y)

ans =
(12*sin(x) + y^2*sin(x) - 5*y^2 + 12)/(y^2 + 12)
```

Approximate Value of Function at Particular Point

Find the value of $\tan(3\pi/4)$. Use `pade` to find the Padé approximant for $\tan(x)$ and substitute into it using `subs` to find $\tan(3\pi/4)$.

```
syms x
f = tan(x);
P = pade(f);
y = subs(P,x,3*pi/4)

y =
(pi*((9*pi^2)/16 - 15))/(4*((9*pi^2)/8 - 5))
```

Use `vpa` to convert `y` into a numeric value.

```
vpa(y)

ans =
-1.2158518789569086447244881326842
```

Increase Accuracy of Padé Approximant

You can increase the accuracy of the Padé approximant by increasing the order. If the expansion point is a pole or a zero, the accuracy can also be increased by setting `OrderMode` to `relative`. The `OrderMode` option has no effect if the expansion point is not a pole or zero.

Find the Padé approximant of $\tan(x)$ using `pade` with an expansion point of θ and `Order` of `[1 1]`. Find the value of $\tan(1/5)$ by substituting into the Padé approximant using `subs`, and use `vpa` to convert $1/5$ into a numeric value.

```
syms x
p11 = pade(tan(x),x,0,'Order',[1 1])
p11 = subs(p11,x,vpa(1/5))

p11 =
x
p11 =
0.2
```

Find the approximation error by subtracting `p11` from the actual value of $\tan(1/5)$.

```
y = tan(vpa(1/5));
error = y - p11

error =
0.0027100355086724833213582716475345
```

Increase the accuracy of the Padé approximant by increasing the order using `Order`. Set `Order` to `[2 2]`, and find the error.

```
p22 = pade(tan(x),x,0,'Order',[2 2])
p22 = subs(p22,x,vpa(1/5));
error = y - p22

p22 =
-(3*x)/(x^2 - 3)
error =
0.0000073328059697806186555689448317799
```

The accuracy increases with increasing order.

If the expansion point is a pole or zero, the accuracy of the Padé approximant decreases. Setting the `OrderMode` option to `relative` compensates for the decreased accuracy. For details, see “Padé Approximant” on page 4-1045. Because the `tan` function has a zero at 0, setting `OrderMode` to `relative` increases accuracy. This option has no effect if the expansion point is not a pole or zero.

```
p22Rel = pade(tan(x),x,0,'Order',[2 2],'OrderMode','relative')
p22Rel = subs(p22Rel,x,vpa(1/5));
error = y - p22Rel
```

```
p22Rel =
(x*(x^2 - 15))/(3*(2*x^2 - 5))
error =
0.0000000084084014806113311713765317725998
```

The accuracy increases if the expansion point is a pole or zero and `OrderMode` is set to `relative`.

Plot Accuracy of Padé Approximant

Plot the difference between $\exp(x)$ and its Padé approximants of orders [1 1] through [4 4]. Use `axis` to focus on the region of interest. The plot shows that accuracy increases with increasing order of the Padé approximant.

```
syms x
expr = exp(x);

hold on
grid on

for i = 1:4
    fplot(expr - pade(expr,'Order',i))
end

axis([-4 4 -4 4])
legend('Order [1,1]', 'Order [2,2]', 'Order [3,3]', 'Order [4,4]', ...
       'Location','Best')
title('Difference Between exp(x) and its Pade Approximant')
ylabel('Error')
```

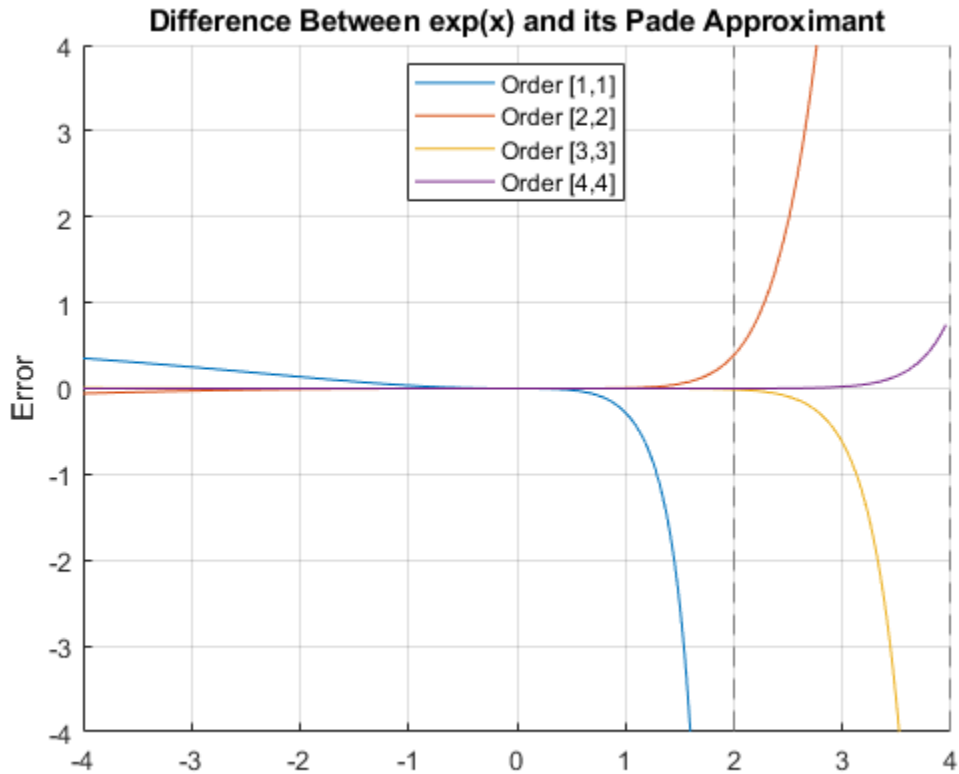

Input Arguments

f — Input to approximate

symbolic number | symbolic variable | symbolic vector | symbolic matrix | symbolic multidimensional array | symbolic function | symbolic expression

Input to approximate, specified as a symbolic number, variable, vector, matrix, multidimensional array, function, or expression.

var — Expansion variable

symbolic variable

Expansion variable, specified as a symbolic variable. If you do not specify `var`, then `pade` uses the default variable determined by `symvar(f, 1)`.

a — Expansion point

number | symbolic number | symbolic variable | symbolic function | symbolic expression

Expansion point, specified as a number, or a symbolic number, variable, function, or expression. The expansion point cannot depend on the expansion variable. You also can specify the expansion point as a `Name, Value` pair argument. If you specify the expansion point both ways, then the `Name, Value` pair argument takes precedence.

Name-Value Pair Arguments

Specify optional comma-separated pairs of `Name`, `Value` arguments. `Name` is the argument name and `Value` is the corresponding value. `Name` must appear inside quotes. You can specify several name and value pair arguments in any order as `Name1, Value1, ..., NameN, ValueN`.

Example: `pade(f, 'Order', [2 2])` returns the Padé approximant of `f` of order `m = 2` and `n = 2`.

ExpansionPoint — Expansion point

number | symbolic number | symbolic variable | symbolic function | symbolic expression

Expansion point, specified as a number, or a symbolic number, variable, function, or expression. The expansion point cannot depend on the expansion variable. You can also specify the expansion point using the input argument `a`. If you specify the expansion point both ways, then the `Name, Value` pair argument takes precedence.

Order — Order of Padé approximant

integer | vector of two integers | symbolic integer | symbolic vector of two integers

Order of the Padé approximant, specified as an integer, a vector of two integers, or a symbolic integer, or vector of two integers. If you specify a single integer, then the integer specifies both the numerator order `m` and denominator order `n` producing a Padé approximant with `m = n`. If you specify a vector of two integers, then the first integer specifies `m` and the second integer specifies `n`. By default, `pade` returns a Padé approximant with `m = n = 3`.

OrderMode — Flag that selects absolute or relative order for Padé approximant

'absolute' (default) | 'relative'

Flag that selects absolute or relative order for Padé approximant, specified as `'absolute'` or `'relative'`. The default value of `'absolute'` uses the standard definition of the Padé approximant. If you set `'OrderMode'` to `'relative'`, it only has an effect when there is a pole or a zero at the expansion point `a`. In this case, to increase accuracy, `pade` multiplies the numerator by $(\text{var} - a)^p$ where `p` is the multiplicity of the zero or pole at the expansion point. For details, see “Padé Approximant” on page 4-1045.

More About

Padé Approximant

By default, `pade` approximates the function $f(x)$ using the standard form of the Padé approximant of order $[m, n]$ around $x = x_0$ which is

$$\frac{a_0 + a_1(x - x_0) + \dots + a_m(x - x_0)^m}{1 + b_1(x - x_0) + \dots + b_n(x - x_0)^n}$$

When `OrderMode` is `relative`, and a pole or zero exists at the expansion point $x = x_0$, the `pade` function uses this form of the Padé approximant

$$\frac{(x - x_0)^p (a_0 + a_1(x - x_0) + \dots + a_m(x - x_0)^m)}{1 + b_1(x - x_0) + \dots + b_n(x - x_0)^n}$$

The parameters `p` and `a0` are given by the leading order term $f = a_0(x - x_0)^p + O((x - x_0)^{p+1})$ of the series expansion of f around $x = x_0$. Thus, `p` is the multiplicity of the pole or zero at `x0`.

Tips

- If you use both the third argument `a` and `ExpansionPoint` to specify the expansion point, the value specified via `ExpansionPoint` prevails.

Algorithms

- The parameters a_1, \dots, b_n are chosen such that the series expansion of the Padé approximant coincides with the series expansion of f to the maximal possible order.
- The expansion points $\pm\infty$ and $\pm i\infty$ are not allowed.
- When `pade` cannot find the Padé approximant, it returns the function call.
- For `pade` to return the Padé approximant, a Taylor or Laurent series expansion of f must exist at the expansion point.

See Also

`series` | `taylor`

Topics

“Padé Approximant” on page 2-69

Introduced in R2014b

partfrac

Partial fraction decomposition

Syntax

```
partfrac(expr, var)
partfrac(expr, var, Name, Value)
```

Description

`partfrac(expr, var)` finds the partial fraction decomposition of `expr` with respect to `var`. If you do not specify `var`, then `partfrac` uses the variable determined by `symvar`.

`partfrac(expr, var, Name, Value)` finds the partial fraction decomposition using additional options specified by one or more `Name, Value` pair arguments.

Examples

Partial Fraction Decomposition of Symbolic Expressions

Find partial fraction decomposition of univariate and multivariate expressions.

First, find partial fraction decomposition of univariate expressions. For expressions with one variable, you can omit specifying the variable.

```
syms x
partfrac(x^2/(x^3 - 3*x + 2))

ans =
5/(9*(x - 1)) + 1/(3*(x - 1)^2) + 4/(9*(x + 2))
```

Find partial fraction decomposition of a multivariate expression with respect to a particular variable.

```
syms a b
partfrac(a^2/(a^2 - b^2), a)

ans =
b/(2*(a - b)) - b/(2*(a + b)) + 1

partfrac(a^2/(a^2 - b^2), b)

ans =
a/(2*(a + b)) + a/(2*(a - b))
```

If you do not specify the variable, then `partfrac` computes partial fraction decomposition with respect to a variable determined by `symvar`.

```
symvar(a^2/(a^2 - b^2), 1)
partfrac(a^2/(a^2 - b^2))

ans =
b
```

```
ans =
a/(2*(a + b)) + a/(2*(a - b))
```

Factorization Modes

Choose a particular factorization mode by using the `FactorMode` input.

Find the partial fraction decomposition without specifying the factorization mode. By default, `partfrac` uses factorization over rational numbers. In this mode, `partfrac` keeps numbers in their exact symbolic form.

```
syms x
f = 1/(x^3 + 2);
partfrac(f,x)
```

```
ans =
1/(x^3 + 2)
```

Repeat the decomposition with numeric factorization over real numbers. In this mode, `partfrac` factors the denominator into linear and quadratic irreducible polynomials with real coefficients. This mode converts all numeric values to floating-point numbers.

```
partfrac(f,x,'FactorMode','real')
```

```
ans =
0.2099868416491455274612017678797/(x + 1.2599210498948731647672106072782) - ...
(0.2099868416491455274612017678797*x - 0.52913368398939982491723521309077)/(x^2 - ...
1.2599210498948731647672106072782*x + 1.5874010519681994747517056392723)
```

Repeat the decomposition with factorization over complex numbers. In this mode, `partfrac` reduces quadratic polynomials in the denominator to linear expressions with complex coefficients. This mode converts all numbers to floating point.

```
partfrac(f,x,'FactorMode','complex')
```

```
ans =
0.2099868416491455274612017678797/(x + 1.2599210498948731647672106072782) + ...
(- 0.10499342082457276373060088393985 - 0.1818539332862023392667876903163i)/...
(x - 0.62996052494743658238360530363911 - 1.0911236359717214035600726141898i) + ...
(- 0.10499342082457276373060088393985 + 0.1818539332862023392667876903163i)/...
(x - 0.62996052494743658238360530363911 + 1.0911236359717214035600726141898i)
```

Find the partial fraction decomposition of this expression using the full factorization mode. In this mode, `partfrac` factors the denominator into linear expressions, reducing quadratic polynomials to linear expressions with complex coefficients. This mode keeps numbers in their exact symbolic form.

```
pfFull = partfrac(f,x,'FactorMode','full')
```

```
pfFull =
2^(1/3)/(6*(x + 2^(1/3))) + ...
(2^(1/3)*((3^(1/2)*1i)/2 - 1/2))/(6*(x + 2^(1/3)*((3^(1/2)*1i)/2 - 1/2))) - ...
(2^(1/3)*((3^(1/2)*1i)/2 + 1/2))/(6*(x - 2^(1/3)*((3^(1/2)*1i)/2 + 1/2)))
```

Approximate the result with floating-point numbers by using `vpa`. Because the expression does not contain any symbolic parameters besides the variable `x`, the result is the same as in complex factorization mode.

```
vpa(pfFull)
```

```
ans =
0.2099868416491455274612017678797/(x + 1.2599210498948731647672106072782) + ...
```

```
(- 0.10499342082457276373060088393985 - 0.18185393932862023392667876903163i)/...
(x - 0.62996052494743658238360530363911 - 1.0911236359717214035600726141898i) + ...
(- 0.10499342082457276373060088393985 + 0.18185393932862023392667876903163i)/...
(x - 0.62996052494743658238360530363911 + 1.0911236359717214035600726141898i)
```

In the complex mode, `partfrac` factors only those expressions in the denominator whose coefficients can be converted to floating-point numbers. Show this by replacing 2 in `f` with a symbolic variable and find the partial fraction decomposition in complex mode. `partfrac` returns the expression unchanged.

```
syms a
f = subs(f,2,a);
partfrac(f,x,'FactorMode','complex')
```

```
ans =
1/(x^3 + a)
```

When you use the full factorization mode, `partfrac` factors expressions in the denominator symbolically. Thus, `partfrac` in the full factorization mode factors the expression.

```
partfrac(1/(x^3 + a), x, 'FactorMode', 'full')
```

```
ans =
1/(3*(-a)^(2/3)*(x - (-a)^(1/3))) - ...
((3^(1/2)*1i)/2 + 1/2)/(3*(-a)^(2/3)*(x + (-a)^(1/3)*((3^(1/2)*1i)/2 + 1/2))) + ...
((3^(1/2)*1i)/2 - 1/2)/(3*(-a)^(2/3)*(x - (-a)^(1/3)*((3^(1/2)*1i)/2 - 1/2)))
```

Full Factorization Mode Returns root

In full factorization mode, `partfrac` represents coefficients using `root` when it is not mathematically possible to find the coefficients as exact symbolic numbers. Show this behavior.

```
syms x
s = partfrac(1/(x^3 + x - 3), x, 'FactorMode','full')

s =
symsum(-(6*root(z^3 + z - 3, z, k)^2)/247 + ...
(27*root(z^3 + z - 3, z, k))/247 + ...
4/247)/(root(z^3 + z - 3, z, k) - x), k, 1, 3)
```

Approximate the result with floating-point numbers by using `vpa`.

```
vpa(s)

ans =
0.1846004942289254798185772017286/(x - 1.2134116627622296341321313773815) + ...
(- 0.092300247114462739909288600864302 + 0.11581130283490645120989658654914i)/...
(x + 0.60670583138111481706606568869074 - 1.450612249188441526515442203395i) + ...
(- 0.092300247114462739909288600864302 - 0.11581130283490645120989658654914i)/...
(x + 0.60670583138111481706606568869074 + 1.450612249188441526515442203395i)
```

Numerators and Denominators of Partial Fraction Decomposition

Return a vector of numerators and a vector of denominators of the partial fraction decomposition.

First, find the partial fraction decomposition of the expression.

```
syms x
P = partfrac(x^2/(x^3 - 3*x + 2), x)

P =
5/(9*(x - 1)) + 1/(3*(x - 1)^2) + 4/(9*(x + 2))
```

Partial fraction decomposition is a sum of fractions. Use the `children` function to return a vector containing the terms of that sum. Then, use `numden` to extract the numerators and denominators of the terms.

```
[N,D] = numden(children(P))

N =
[ 5, 1, 4]

D =
[ 9*x - 9, 3*(x - 1)^2, 9*x + 18]
```

Reconstruct the partial fraction decomposition from the vectors of numerators and denominators.

```
P1 = sum(N./D)

P1 =
1/(3*(x - 1)^2) + 5/(9*x - 9) + 4/(9*x + 18)
```

Verify that the reconstructed expression, `P1`, is equivalent to the original partial fraction decomposition, `P`.

```
isAlways(P1 == P)

ans =
    logical
     1
```

Input Arguments

expr — Rational expression

symbolic expression | symbolic function

Rational expression, specified as a symbolic expression or function.

var — Variable of interest

symbolic variable

Variable of interest, specified as a symbolic variable.

Name-Value Pair Arguments

Specify optional comma-separated pairs of `Name`, `Value` arguments. `Name` is the argument name and `Value` is the corresponding value. `Name` must appear inside quotes. You can specify several name and value pair arguments in any order as `Name1`, `Value1`, ..., `NameN`, `ValueN`.

Example: `partfrac(1/(x^3 - 2),x,'FactorMode','real')`

FactorMode — Factorization mode

'rational' (default) | 'real' | 'complex' | 'full'

Factorization mode, specified as the comma-separated pair consisting of 'FactorMode' and one of these character vectors.

'rational'	Factorization over rational numbers.
------------	--------------------------------------

'real'	Factorization into linear and quadratic polynomials with real coefficients. The coefficients of the input must be convertible to real floating-point numbers.
'complex'	Factorization into linear polynomials whose coefficients are floating-point numbers. The coefficients of the input must be convertible to floating-point numbers.
'full'	Factorization into linear polynomials with exact symbolic coefficients. If <code>partfrac</code> cannot calculate coefficients as exact symbolic numbers, then <code>partfrac</code> represents coefficients by using <code>symsum</code> ranging over a root.

More About

Partial Fraction Decomposition

Partial fraction decomposition is an operation on rational expressions.

$$f(x) = g(x) + \frac{p(x)}{q(x)},$$

Where the denominator of the expression can be written as $q(x) = q_1(x)q_2(x)\dots$, the partial fraction decomposition is an expression of this form.

$$f(x) = g(x) + \sum_j \frac{p_j(x)}{q_j(x)}$$

Here, the denominators $q_j(x)$ are irreducible polynomials or powers of irreducible polynomials. The numerators $p_j(x)$ are polynomials of smaller degrees than the corresponding denominators $q_j(x)$.

Partial fraction decomposition can simplify integration by integrating each term of the returned expression separately.

See Also

`children` | `coeffs` | `collect` | `combine` | `compose` | `divisors` | `expand` | `factor` | `horner` | `numden` | `rewrite` | `simplify` | `simplifyFraction`

Topics

"Choose Function to Rearrange Expression" on page 2-104

Introduced in R2015a

piecewise

Conditionally defined expression or function

Syntax

```
pw = piecewise(cond1, val1, cond2, val2, ...)
pw = piecewise(cond1, val1, cond2, val2, ..., otherwiseVal)
```

Description

`pw = piecewise(cond1, val1, cond2, val2, ...)` returns the piecewise expression or function `pw` whose value is `val1` when condition `cond1` is true, is `val2` when `cond2` is true, and so on. If no condition is true, the value of `pw` is `NaN`.

`pw = piecewise(cond1, val1, cond2, val2, ..., otherwiseVal)` returns the piecewise expression or function `pw` that has the value `otherwiseVal` if no condition is true.

Examples

Define and Evaluate Piecewise Expression

Define the following piecewise expression by using `piecewise`.

$$y = \begin{cases} -1 & x < 0 \\ 1 & x > 0 \end{cases}$$

```
syms x
y = piecewise(x<0, -1, x>0, 1)
```

```
y =
piecewise(x < 0, -1, 0 < x, 1)
```

Evaluate `y` at `-2`, `0`, and `2` by using `subs` to substitute for `x`. Because `y` is undefined at `x = 0`, the value is `NaN`.

```
subs(y, x, [-2 0 2])
```

```
ans =
[ -1, NaN, 1]
```

Define Piecewise Function

Define the following function symbolically.

$$y(x) = \begin{cases} -1 & x < 0 \\ 1 & x > 0 \end{cases}$$

```
syms y(x)
y(x) = piecewise(x<0, -1, x>0, 1)
```

```
y(x) =
piecewise(x < 0, -1, 0 < x, 1)
```

Because $y(x)$ is a symbolic function, you can directly evaluate it for values of x . Evaluate $y(x)$ at -2 , 0 , and 2 . Because $y(x)$ is undefined at $x = 0$, the value is NaN. For details, see “Create Symbolic Functions” on page 1-7.

```
y([-2 0 2])
ans =
[ -1, NaN, 1]
```

Set Value When No Conditions Is True

Set the value of a piecewise function when no condition is true (called *otherwise value*) by specifying an additional input argument. If an additional argument is not specified, the default otherwise value of the function is NaN.

Define the piecewise function

$$y(x) = \begin{cases} -2 & x < -2 \\ 0 & -2 < x < 0 \\ 1 & \text{otherwise} \end{cases}$$

```
syms y(x)
y(x) = piecewise(x<-2, -2, -2<x<0, 0, 1)
y(x) =
piecewise(x < -2, -2, x in Dom::Interval(-2, 0), 0, 1)
```

Evaluate $y(x)$ between -3 and 1 by generating values of x using `linspace`. At -2 and 0 , $y(x)$ evaluates to 1 because the other conditions are not true.

```
xvalues = linspace(-3,1,5)
yvalues = y(xvalues)
xvalues =
    -3    -2    -1     0     1
yvalues =
[ -2, 1, 0, 1, 1]
```

Plot Piecewise Expression

Plot the following piecewise expression by using `fplot`.

$$y = \begin{cases} -2 & x < -2 \\ x & -2 < x < 2 \\ 2 & x > 2 \end{cases}$$

```
syms x
y = piecewise(x<-2, -2, -2<x<2, x, x>2, 2);
fplot(y)
```

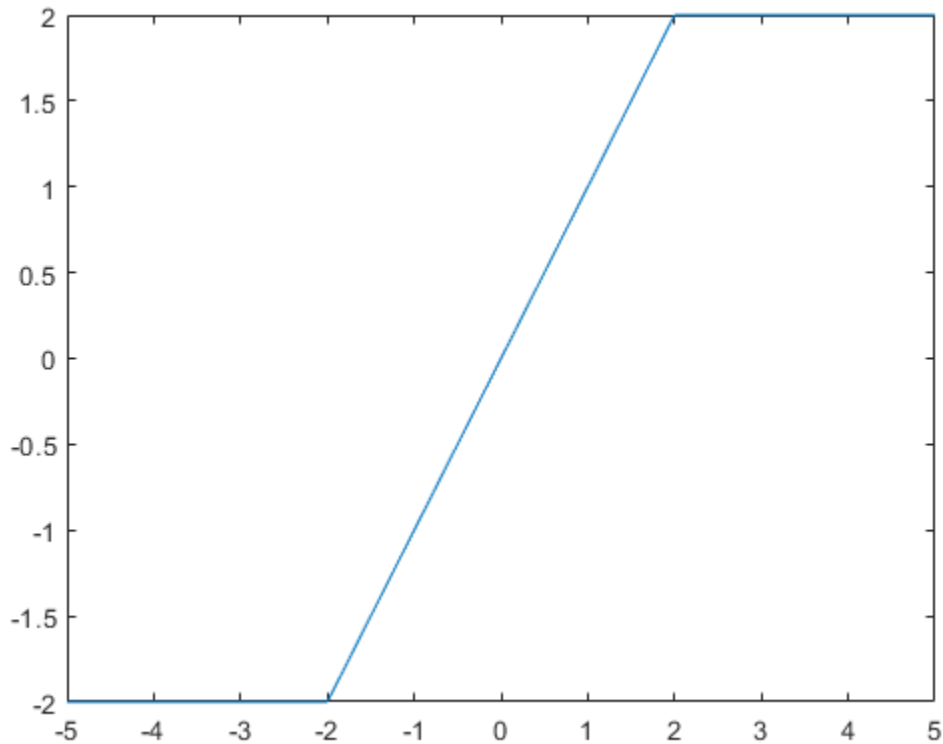

Assumptions and Piecewise Expressions

On creation, a piecewise expression applies existing assumptions. Apply assumptions set after creating the piecewise expression by using `simplify` on the expression.

Assume $x > 0$. Then define a piecewise expression with the same condition $x > 0$. `piecewise` automatically applies the assumption to simplify the condition.

```
syms x
assume(x > 0)
pw = piecewise(x<0, -1, x>0, 1)
```

```
pw =
1
```

Clear the assumption on x for further computations.

```
assume(x, 'clear')
```

Create a piecewise expression `pw` with the condition $x > 0$. Then set the assumption that $x > 0$. Apply the assumption to `pw` by using `simplify`.

```
pw = piecewise(x<0, -1, x>0, 1);
assume(x > 0)
pw = simplify(pw)
```

```
pw =
1
```

Clear the assumption on x for further computations.

```
assume(x, 'clear')
```

Differentiate, Integrate, and Find Limits of Piecewise Expression

Differentiate, integrate, and find limits of a piecewise expression by using `diff`, `int`, and `limit` respectively.

Differentiate the following piecewise expression by using `diff`.

$$y = \begin{cases} 1/x & x < -1 \\ \sin(x)/x & x \geq -1 \end{cases}$$

```
syms x
y = piecewise(x<-1, 1/x, x>=-1, sin(x)/x);
diffy = diff(y, x)

diffy =
piecewise(x < -1, -1/x^2, -1 < x, cos(x)/x - sin(x)/x^2)
```

Integrate y by using `int`.

```
inty = int(y, x)

inty =
piecewise(x < -1, log(x), -1 <= x, sinint(x))
```

Find the limits of y at 0 and -1 by using `limit`. Because `limit` finds the double-sided limit, the piecewise expression must be defined from both sides. Alternatively, you can find the right- or left-sided limit. For details, see `limit`.

```
limit(y, x, 0)
limit(y, x, -1)

ans =
1
ans =
limit(piecewise(x < -1, 1/x, -1 < x, sin(x)/x), x, -1)
```

Because the two conditions meet at -1 , the limits from both sides differ and `limit` cannot find a double-sided limit.

Elementary Operations on Piecewise Expressions

Add, subtract, divide, and multiply two piecewise expressions. The resulting piecewise expression is only defined where the initial piecewise expressions are defined.

```
syms x
pw1 = piecewise(x<-1, -1, x>=-1, 1);
pw2 = piecewise(x<0, -2, x>=0, 2);
add = pw1 + pw2
sub = pw1 - pw2
mul = pw1 * pw2
div = pw1 / pw2
```

```

add =
piecewise(x < -1, -3, x in Dom::Interval([-1], 0), -1, 0 <= x, 3)
sub =
piecewise(x < -1, 1, x in Dom::Interval([-1], 0), 3, 0 <= x, -1)
mul =
piecewise(x < -1, 2, x in Dom::Interval([-1], 0), -2, 0 <= x, 2)
div =
piecewise(x < -1, 1/2, x in Dom::Interval([-1], 0), -1/2, 0 <= x, 1/2)

```

Modify or Extend Piecewise Expression

Modify a piecewise expression by replacing part of the expression using `subs`. Extend a piecewise expression by specifying the expression as the otherwise value of a new piecewise expression. This action combines the two piecewise expressions. `piecewise` does not check for overlapping or conflicting conditions. Instead, like an if-else ladder, `piecewise` returns the value for the first true condition.

Change the condition $x < 2$ in a piecewise expression to $x < 0$ by using `subs`.

```

syms x
pw = piecewise(x < 2, -1, x > 0, 1);
pw = subs(pw, x < 2, x < 0)

```

```

pw =
piecewise(x < 0, -1, 0 < x, 1)

```

Add the condition $x > 5$ with the value $1/x$ to `pw` by creating a new piecewise expression with `pw` as the otherwise value.

```

pw = piecewise(x > 5, 1/x, pw)

pw =
piecewise(5 < x, 1/x, x < 0, -1, 0 < x, 1)

```

Input Arguments

cond — Condition

symbolic condition | symbolic variable

Condition, specified as a symbolic condition or variable. A symbolic variable represents an unknown condition.

Example: $x > 2$

val — Value when condition is satisfied

number | vector | matrix | multidimensional array | symbolic number | symbolic variable | symbolic vector | symbolic matrix | symbolic multidimensional array | symbolic function | symbolic expression

Value when condition is satisfied, specified as a number, vector, matrix, or multidimensional array, or as a symbolic number, variable, vector, matrix, multidimensional array, function, or expression.

otherwiseVal — Value if no conditions are true

number | vector | matrix | multidimensional array | symbolic number | symbolic variable | symbolic vector | symbolic matrix | symbolic multidimensional array | symbolic function | symbolic expression

Value if no conditions are true, specified as a number, vector, matrix, or multidimensional array, or as a symbolic number, variable, vector, matrix, multidimensional array, function, or expression. If `otherwiseVal` is not specified, its value is `NaN`.

Output Arguments

pw — Piecewise expression or function

symbolic expression | symbolic function

Piecewise expression or function, returned as a symbolic expression or function. The value of `pw` is the value `val` of the first condition `cond` that is true. To find the value of `pw`, use `subs` to substitute for variables in `pw`.

Tips

- `piecewise` does not check for overlapping or conflicting conditions. A piecewise expression returns the value of the first true condition and disregards any following true expressions. Thus, `piecewise` mimics an if-else ladder.

See Also

`and` | `assume` | `assumeAlso` | `assumptions` | `if` | `in` | `isAlways` | `not` | `or`

Introduced in R2016b

pinv

Moore-Penrose inverse (pseudoinverse) of symbolic matrix

Syntax

```
X = pinv(A)
```

Description

$X = \text{pinv}(A)$ returns the pseudoinverse of A . Pseudoinverse is also called the Moore-Penrose inverse.

Examples

Compute Pseudoinverse of Matrix

Compute the pseudoinverse of this matrix. Because these numbers are not symbolic objects, you get floating-point results.

```
A = [1 1i 3; 1 3 2];
X = pinv(A)
```

```
X =
    0.0729 + 0.0312i    0.0417 - 0.0312i
   -0.2187 - 0.0521i    0.3125 + 0.0729i
    0.2917 + 0.0625i    0.0104 - 0.0938i
```

Now, convert this matrix to a symbolic object, and compute the pseudoinverse.

```
A = sym([1 1i 3; 1 3 2]);
X = pinv(A)
```

```
X =
[ 7/96 + 1i/32, 1/24 - 1i/32]
[ - 7/32 - 5i/96, 5/16 + 7i/96]
[ 7/24 + 1i/16, 1/96 - 3i/32]
```

Check that $A*X*A = A$ and $X*A*X = X$.

```
isAlways(A*X*A == A)
```

```
ans =
 2×3 logical array
     1     1     1
     1     1     1
```

```
isAlways(X*A*X == X)
```

```
ans =
 3×2 logical array
     1     1
     1     1
     1     1
```

Now, verify that $A*X$ and $X*A$ are Hermitian matrices.

```
isAlways(A*X == (A*X)')
```

```
ans =
  2x2 logical array
   1     1
   1     1
```

```
isAlways(X*A == (X*A)')
```

```
ans =
  3x3 logical array
   1     1     1
   1     1     1
   1     1     1
```

Compute Pseudoinverse of Matrix

Compute the pseudoinverse of this matrix.

```
syms a
A = [1 a; -a 1];
X = pinv(A)
```

```
X =
[ (a*conj(a) + 1)/(a^2*conj(a)^2 + a^2 + conj(a)^2 + 1) -...
  (conj(a)*(a - conj(a)))/(a^2*conj(a)^2 + a^2 + conj(a)^2 + 1),
  - (a - conj(a))/(a^2*conj(a)^2 + a^2 + conj(a)^2 + 1) -...
  (conj(a)*(a*conj(a) + 1))/(a^2*conj(a)^2 + a^2 + conj(a)^2 + 1)]
[ (a - conj(a))/(a^2*conj(a)^2 + a^2 + conj(a)^2 + 1) +...
  (conj(a)*(a*conj(a) + 1))/(a^2*conj(a)^2 + a^2 + conj(a)^2 + 1),
  (a*conj(a) + 1)/(a^2*conj(a)^2 + a^2 + conj(a)^2 + 1) -...
  (conj(a)*(a - conj(a)))/(a^2*conj(a)^2 + a^2 + conj(a)^2 + 1)]
```

Now, compute the pseudoinverse of A assuming that a is real.

```
assume(a, 'real')
A = [1 a; -a 1];
X = pinv(A)
```

```
X =
[ 1/(a^2 + 1), -a/(a^2 + 1)]
[ a/(a^2 + 1), 1/(a^2 + 1)]
```

For further computations, remove the assumption on a by recreating it using `syms`.

```
syms a
```

Input Arguments

A — Input

symbolic matrix

Input, specified as a symbolic matrix.

Output Arguments

X — Pseudoinverse of matrix

symbolic matrix

Pseudoinverse of matrix, returned as a symbolic matrix, such that $A*X*A = A$ and $X*A*X = X$.

More About

Moore-Penrose Pseudoinverse

The pseudoinverse of an m -by- n matrix A is an n -by- m matrix X , such that $A*X*A = A$ and $X*A*X = X$. The matrices $A*X$ and $X*A$ must be Hermitian.

Tips

- Calling `pinv` for numeric arguments that are not symbolic objects invokes the MATLAB `pinv` function.
- For an invertible matrix A , the Moore-Penrose inverse X of A coincides with the inverse of A .

See Also

`inv` | `pinv` | `rank` | `svd`

Introduced in R2013a

playAnimation

Play animation objects in a MATLAB figure window

Syntax

```
playAnimation  
playAnimation(fig)  
playAnimation( ___,Name,Value)
```

Description

`playAnimation` plays animation objects in a MATLAB figure window. The animation objects must be created using the `f Animator` function.

By default, the variable `t = sym('t')` is the time parameter of the animation objects. `playAnimation` plays the animation with 10 frames per unit interval of `t` within the range of `t` from 0 to 10.

`playAnimation(fig)` plays animation objects in the figure `fig`.

`playAnimation(___,Name,Value)` plays the animation objects with the specified `Name,Value` pair arguments. Use this option with any of the input argument combinations in the previous syntaxes.

Examples

Animate Moving Circle

First, create an animation object of a moving circle using `f Animator`.

Create two symbolic variables, `t` and `x`. The variable `t` defines the time parameter of the animation. Use `t` to set the center of the circle at $(t, 1)$ and `x` to parameterize the perimeter of the circle within the range $[-\pi, \pi]$. Set the `x`-axis and `y`-axis to be equal length.

```
syms t x  
f Animator(@fplot,cos(x)+t,sin(x)+1,[-pi pi])  
axis equal
```

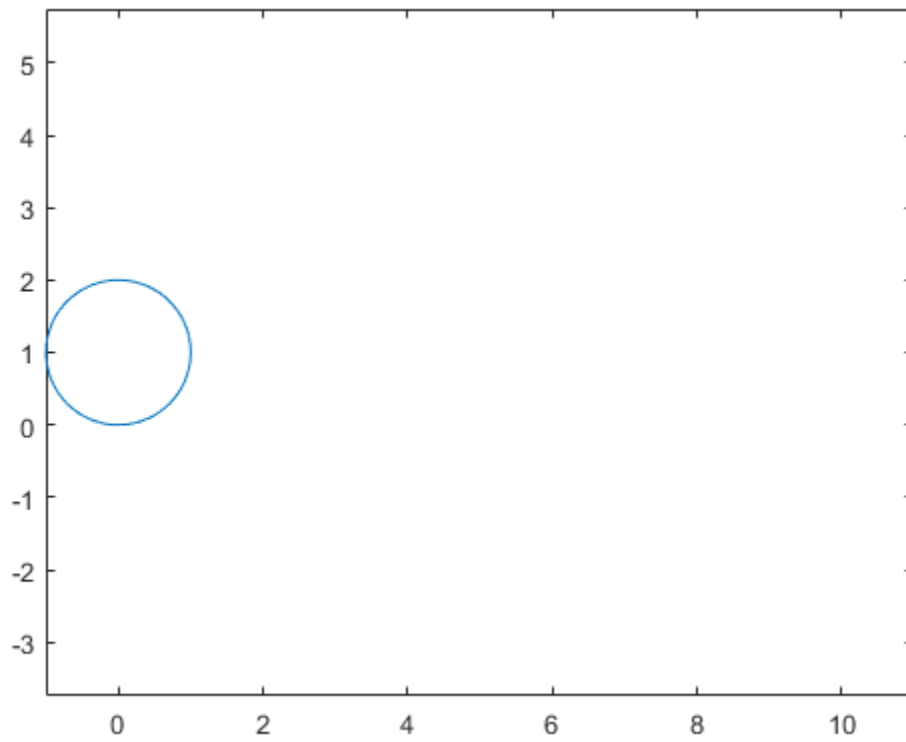

Next, enter the command `playAnimation` to play the animation.

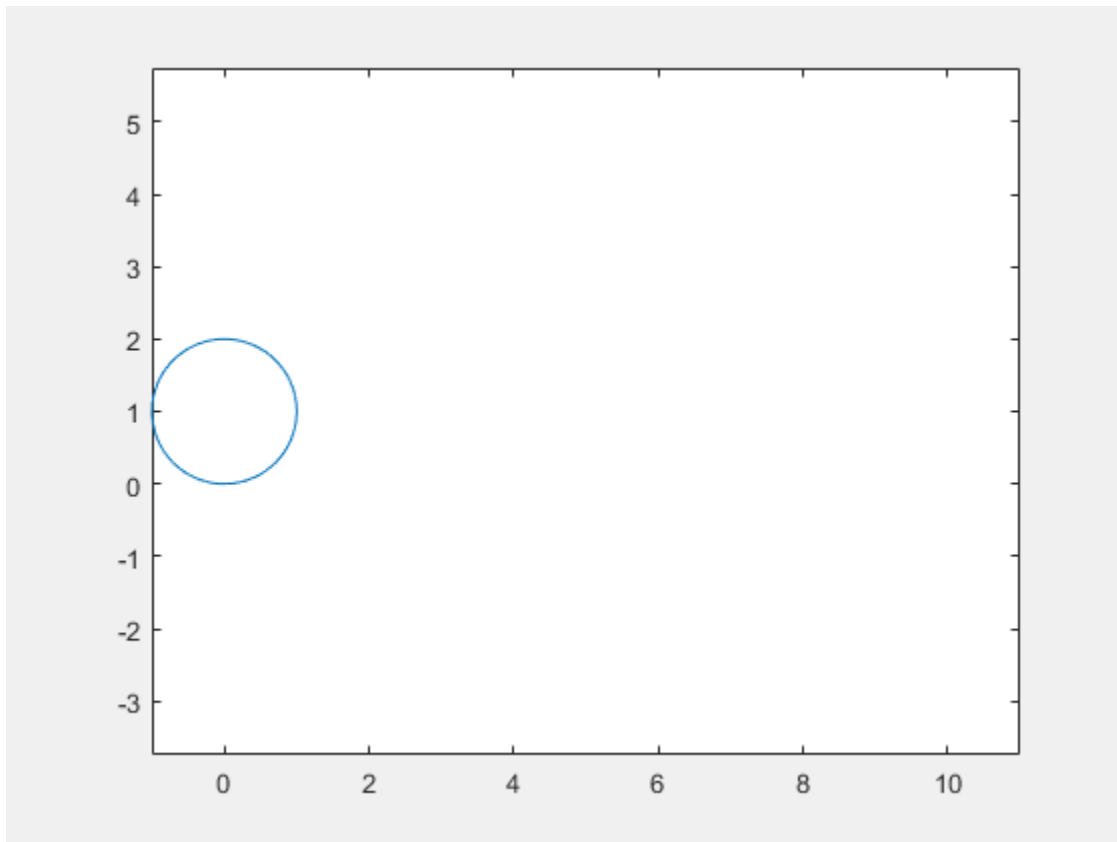

By default, `playAnimation` plays an animation with 10 generated frames per unit time within the range of t from 0 to 10.

Animate Moving Circle with Timer

Create two symbolic variables, t and x . The variable t defines the time parameter of the animation.

```
syms t x
```

Create a circle animation object using `f animator`. Use t to set the center of the circle at $(t, 1)$ and x to parameterize the perimeter of the circle within the range $[-\pi, \pi]$. Set the x -axis and y -axis to be equal length.

```
f animator(@fplot,cos(x)+t,sin(x)+1,[-pi pi])
axis equal
```

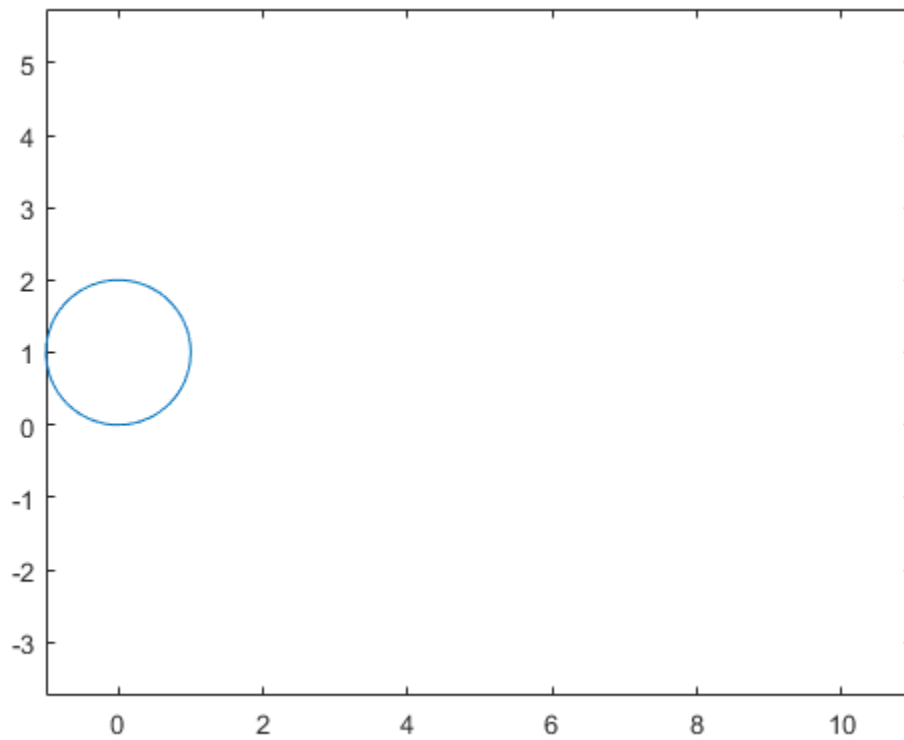

Add a piece of text to count the elapsed time by using the `text` function. Use `num2str` to convert the time parameter to a string.

```
hold on
fanimation(@() text(9,3,"Timer: "+num2str(t,2)))
hold off
```

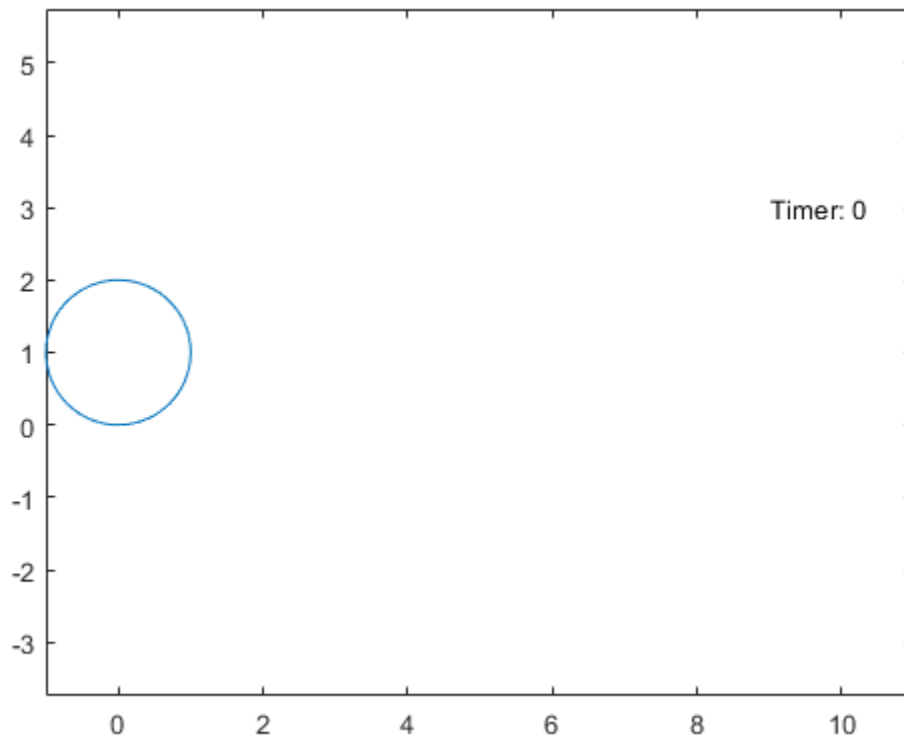

By default, `playAnimation` plays the animation with 10 generated frames per unit time within the range of `t` from 0 to 10. Change the range of the time parameter to `[4 8]` using the `'AnimationRange'` property. Change the frame rate per unit time to 4 using the `'FrameRate'` property. Play the animation in the current figure by entering the following command.

```
playAnimation(gcf,'AnimationRange',[4 8],'FrameRate',4)
```

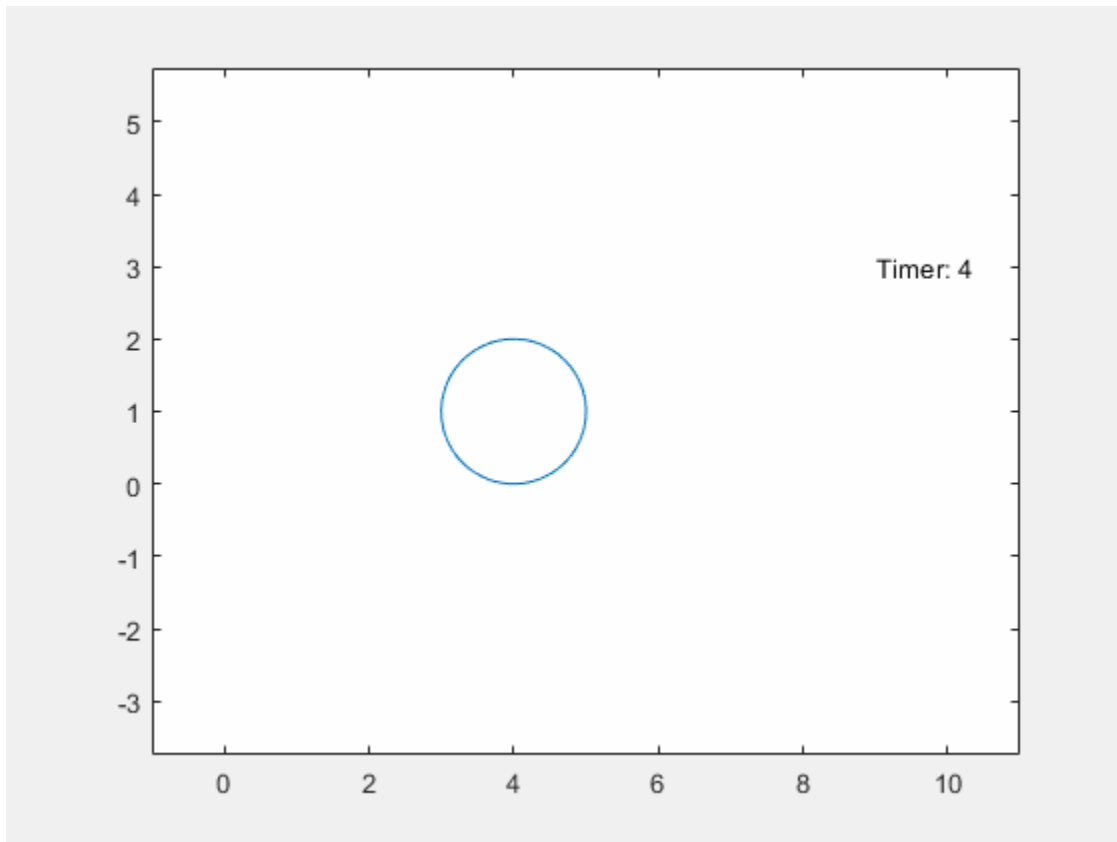

Create Animation in UI Figure

Create a UI figure. Specify the UI axes of the figure.

```
fig = uifigure;  
ax = uiaxes(fig);
```

Add an animation object to the UI axes using `f animator`. Create two symbolic variables, `x` and `t`. Plot a curve that grows exponentially as a function of time `t` within the interval `[0 3]`.

```
syms x t;  
f animator(ax,@fplot,exp(x),[0 t], 'r', 'AnimationRange',[0 3])
```

Play the animation in the UI figure `fig` by entering the command `playAnimation(fig)`. Alternatively, you can also use the command `playAnimation(ax.Parent)`.

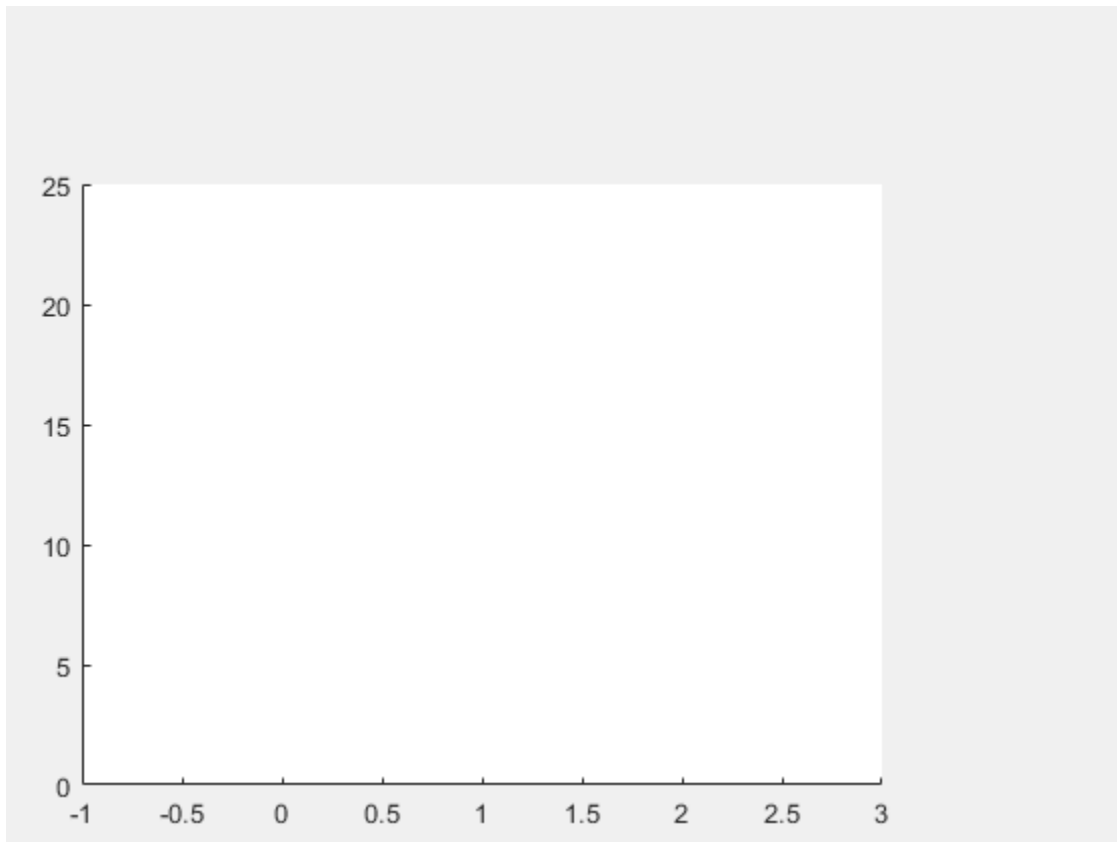

Copyright 2018 The MathWorks, Inc.

Input Arguments

fig — Target figure

Figure object

Target figure, specified as a Figure object. For more information about Figure objects, see [figure](#).

Name-Value Pair Arguments

Specify optional comma-separated pairs of **Name**, **Value** arguments. **Name** is the argument name and **Value** is the corresponding value. **Name** must appear inside quotes. You can specify several name and value pair arguments in any order as **Name1**, **Value1**, ..., **NameN**, **ValueN**.

Example: `'Backwards',true,'FrameRate',25`

AnimationRange — Range of animation time parameter

`[0 10]` (default) | two-element row vector

Range of the animation time parameter, specified as a two-element row vector. The two elements must be real values that are increasing.

Example: `[-2 4.5]`

FrameRate — Frame rate

10 (default) | positive value

Frame rate, specified as a positive value. The frame rate defines the number of frames per unit time when playing the animation objects.

Example: 30

Backwards — Backward option

logical 0 (false) (default) | logical value (boolean)

Backward option, specified as a logical value (boolean). If you specify the option `true`, then the function plays the animation backwards.

Example: `true`

SpeedFactor — Speed factor

1 (default) | real nonzero value

Speed factor, specified as a real nonzero value. The speed factor sets the ratio of one unit interval of the animation time parameter to one second of clock time.

- If you specify a negative value for 'SpeedFactor' and keep the default value 0 (false) for 'Backwards' option, then the function plays the animation backwards with the specified speed factor. For example, `playAnimation('SpeedFactor', -1)` launches the same animation as `playAnimation('Backwards', true)`.
- If you specify a zero value for 'SpeedFactor', then `playAnimation('SpeedFactor', 0)` launches a still frame indefinitely and does not play any animation.

Example: 2

Tips

- When you create a graph by using a plotting function, such as `fplot`, MATLAB creates a series of graphics objects. You can then animate a specific property of the graphics objects by using the `fimator` and the `playAnimation` functions. Note that some functions, such as `title` and `xlabel`, create text objects that cannot be animated. Instead, use the `text` function to create text objects that can be animated.

See Also

`animationToFrame` | `fimator` | `rewindAnimation` | `writeAnimation`

Introduced in R2019a

plus, +

Symbolic addition

Syntax

```
A + B
plus(A,B)
```

Description

$A + B$ adds A and B .

`plus(A,B)` is equivalent to $A + B$.

Examples

Add Scalar to Array

`plus` adds x to each element of the array.

```
syms x
A = [x sin(x) 3];
A + x

ans =

[ 2*x, x + sin(x), x + 3]
```

Add Two Matrices

Add the identity matrix to matrix M .

```
syms x
M = [x x^2; Inf 0];
M + eye(2)

ans =

[ x + 1, x^2]
[ Inf, 1]
```

Alternatively, use `plus(M,eye(2))`.

```
plus(M,eye(2))

ans =

[ x + 1, x^2]
[ Inf, 1]
```

Add Symbolic Functions

```
syms f(x) g(x)
f(x) = x^2 + 5*x + 6;
```

```
g(x) = 3*x - 2;  
h = f + g
```

```
h(x) =  
x^2 + 8*x + 4
```

Add Expression to Symbolic Function

Add expression `expr` to function `f`.

```
syms f(x)  
f(x) = x^2 + 3*x + 2;  
expr = x^2 - 2;  
f(x) = f(x) + expr
```

```
f(x) =  
2*x^2 + 3*x
```

Input Arguments

A — Input

symbolic variable | symbolic vector | symbolic matrix | symbolic multidimensional array | symbolic function | symbolic expression

Input, specified as a symbolic variable, vector, matrix, multidimensional array, function, or expression.

B — Input

symbolic variable | symbolic vector | symbolic matrix | symbolic multidimensional array | symbolic function | symbolic expression

Input, specified as a symbolic variable, vector, matrix, multidimensional array, function, or expression.

Tips

- All nonscalar arguments must be the same size. If one input argument is nonscalar, then `plus` expands the scalar into an array of the same size as the nonscalar argument, with all elements equal to the scalar.

See Also

`ctranspose` | `ldivide` | `minus` | `mldivide` | `mpower` | `mrdivide` | `mtimes` | `power` | `rdivide` | `times` | `transpose`

Introduced before R2006a

pochhammer

Pochhammer symbol

Syntax

`pochhammer(x,n)`

Description

`pochhammer(x,n)` returns the “Pochhammer Symbol” on page 4-1073 $(x)_n$.

Examples

Find Pochhammer Symbol for Numeric and Symbolic Inputs

Find the Pochhammer symbol for the numeric inputs $x = 3$ at $n = 2$.

```
pochhammer(3,2)
```

```
ans =
    12
```

Find the Pochhammer symbol for the symbolic input x at $n = 3$. The `pochhammer` function does not automatically return the expanded form of the expression. Use `expand` to force `pochhammer` to return the form of the expanded expression.

```
syms x
P = pochhammer(x, 3)
P = expand(P)
```

```
P =
pochhammer(x, 3)
P =
x^3 + 3*x^2 + 2*x
```

Rewrite and Factor Outputs of Pochhammer

If conditions are satisfied, `expand` rewrites the solution using `gamma`.

```
syms n x
assume(x>0)
assume(n>0)
P = pochhammer(x, n);
P = expand(P)
```

```
P =
gamma(n + x)/gamma(x)
```

To use the variables in further computations, clear their assumptions by recreating them using `syms`.

```
syms n x
```

To convert expanded output of `pochhammer` into its factors, use `factor`.

```
P = expand(pochhammer(x, 4));  
P = factor(P)
```

```
P =  
[ x, x + 3, x + 2, x + 1]
```

Differentiate Pochhammer Symbol

Differentiate `pochhammer` once with respect to `x`.

```
syms n x  
diff(pochhammer(x,n),x)
```

```
ans =  
pochhammer(x, n)*(psi(n + x) - psi(x))
```

Differentiate `pochhammer` twice with respect to `n`.

```
diff(pochhammer(x,n),n,2)
```

```
ans =  
pochhammer(x, n)*psi(n + x)^2 + pochhammer(x, n)*psi(1, n + x)
```

Taylor Series Expansion of Pochhammer Symbol

Use `taylor` to find the Taylor series expansion of `pochhammer` with `n = 3` around the expansion point `x = 2`.

```
syms x  
taylor(pochhammer(x,3),x,2)
```

```
ans =  
26*x + 9*(x - 2)^2 + (x - 2)^3 - 28
```

Plot Pochhammer Symbol

Plot the Pochhammer symbol from `n = 0` to `n = 4` for `x`. Use `axis` to display the region of interest.

```
syms x  
fplot(pochhammer(x,0:4))  
axis([-4 4 -4 4])
```

```
grid on  
legend('n = 0', 'n = 1', 'n = 2', 'n = 3', 'n = 4', 'Location', 'Best')  
title('Pochhammer symbol (x)_n for n=0 to n=4')
```

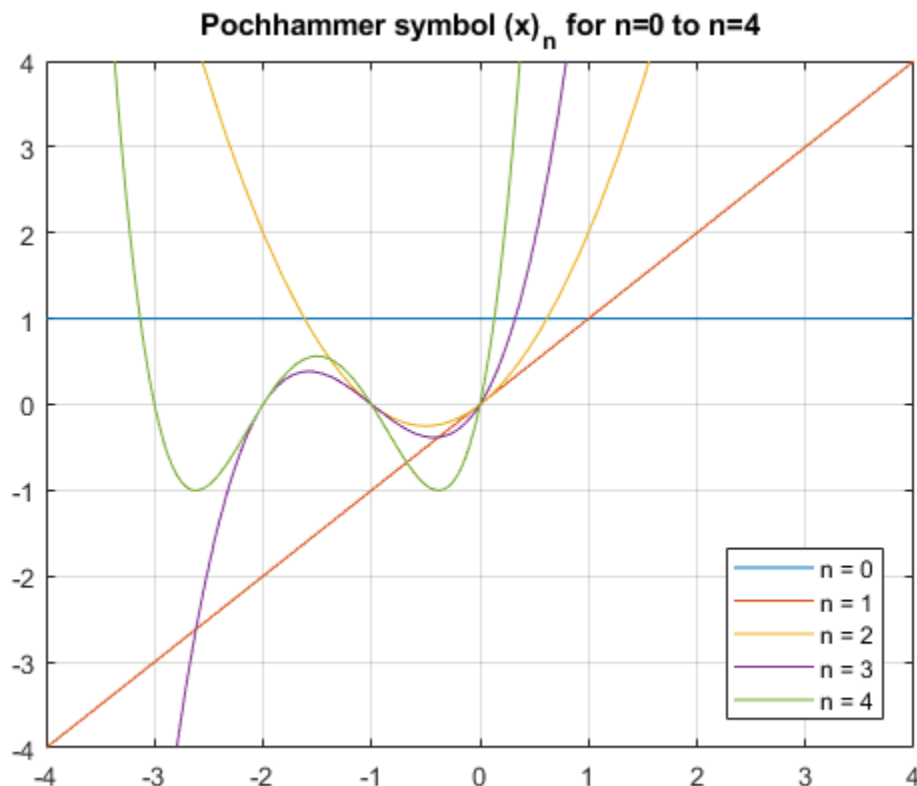

Input Arguments

x – Input

number | vector | matrix | multidimensional array | symbolic number | symbolic variable | symbolic vector | symbolic matrix | symbolic multidimensional array | symbolic function | symbolic expression

Input, specified as a number, vector, matrix, or multidimensional array, or a symbolic number, variable, vector, matrix, multidimensional array, function, or expression.

n – Input

number | vector | matrix | multidimensional array | symbolic number | symbolic variable | symbolic vector | symbolic matrix | symbolic multidimensional array | symbolic function | symbolic expression

Input, specified as a number, vector, matrix, or multidimensional array, or a symbolic number, variable, vector, matrix, multidimensional array, function, or expression.

More About

Pochhammer Symbol

Pochhammer's symbol is defined as

$$(x)_n = \frac{\Gamma(x+n)}{\Gamma(x)},$$

where Γ is the Gamma function.

If n is a positive integer, Pochhammer's symbol is

$$(x)_n = x(x + 1)\dots(x + n - 1)$$

Algorithms

- If x and n are numerical values, then an explicit numerical result is returned. Otherwise, a symbolic function call is returned.
- If both x and $x + n$ are nonpositive integers, then

$$(x)_n = (-1)^n \frac{\Gamma(1 - x)}{\Gamma(1 - x - n)}.$$

- The following special cases are implemented.

$$(x)_0 = 1$$

$$(x)_1 = x$$

$$(x)_{-1} = \frac{1}{x - 1}$$

$$(1)_n = \Gamma(n + 1)$$

$$(2)_n = \Gamma(n + 2)$$

- If n is a positive integer, then `expand(pochhammer(x, n))` returns the expanded polynomial $x(x + 1)\dots(x + n - 1)$.
- If n is not an integer, then `expand(pochhammer(x, n))` returns a representation in terms of gamma.

See Also

`factorial` | `gamma`

Introduced in R2014b

poles

Poles of expression or function

Syntax

```
P = poles(f,var)
P = poles(f,var,a,b)
[P,N] = poles(____)
[P,N,R] = poles(____)
```

Description

`P = poles(f,var)` finds the poles of `f` with respect to variable `var`.

`P = poles(f,var,a,b)` returns poles in the interval `(a,b)`.

`[P,N] = poles(____)` returns the poles of `f` and their orders in `N`.

`[P,N,R] = poles(____)` returns the poles of `f`, their orders, and residues in `R`.

Examples

Find Poles of Symbolic Expressions

```
syms x
poles(1/(x-1i))
```

```
ans =
1i
```

```
poles(sin(x)/(x-1))
```

```
ans =
1
```

Specify Independent Variable

Find the poles of this expression. If you do not specify a variable, `poles` uses the default variable determined by `symvar`.

```
syms x a
f = 1/((x-1)*(a-2));
poles(f)
```

```
ans =
1
```

Find the poles with respect to `a` by specifying the second argument.

```
syms x a
poles(f,a)

ans =
2
```

Find Poles in Interval

Find the poles of the tangent function in the interval $(-\pi, \pi)$.

```
syms x
poles(tan(x), x, -pi, pi)

ans =
-pi/2
 pi/2
```

The tangent function has an infinite number of poles. If you do not specify the interval, `poles` cannot find all of them. It issues a warning and returns an empty symbolic object.

```
syms x
poles(tan(x))
```

```
Warning: Unable to determine poles.
ans =
Empty sym: 0-by-1
```

If `poles` can prove that the input does not have poles in the interval, it returns empty without issuing a warning.

```
syms x
poles(tan(x), x, -1, 1)

ans =
Empty sym: 0-by-1
```

Return Order of Poles

Return orders along with poles by using two output arguments. Restrict the search interval to $(-\pi, \pi)$.

```
syms x
[Poles, Orders] = poles(tan(x)/(x-1)^3, x, -pi, pi)

Poles =
-pi/2
 pi/2
 1

Orders =
1
1
3
```

Return Order and Residue of Poles

Return the residues and orders along with the poles by specifying three output arguments.

```
syms x a
[Poles, Orders, Residues] = poles(a/(x^2*(x-1)), x)

Poles =
     1
     0
Orders =
     1
     2
Residues =
     a
    -a
```

Input Arguments

f — Input

symbolic expression | symbolic function.

Input, specified as a symbolic expression or function.

var — Independent variable

symbolic variable

Independent variable, specified as a symbolic variable.

a, b — Search interval for poles

vector of two real numbers | vector of two real symbolic numbers

Search interval for poles, specified as a vector of two real numeric or symbolic numbers (including infinities).

Tips

- If `poles` cannot find all nonremovable singularities and cannot prove that they do not exist, it issues a warning and returns an empty symbolic object.
- If `poles` can prove that the input does not have poles (in the specified interval or complex plane), it returns empty without issuing a warning.
- `a` and `b` must be real numbers or infinities. If you provide complex numbers, `poles` uses an empty interval and returns an empty symbolic object.

See Also

`limit` | `solve` | `symvar` | `vpasolve`

Introduced in R2012b

poly2sym

Create symbolic polynomial from vector of coefficients

Syntax

```
p = poly2sym(c)
p = poly2sym(c,var)
```

Description

`p = poly2sym(c)` creates the symbolic polynomial expression `p` from the vector of coefficients `c`. The polynomial variable is `x`. If `c = [c1,c2,...,cn]`, then `p = poly2sym(c)` returns $c_1x^{n-1} + c_2x^{n-2} + \dots + c_n$.

This syntax does not create the symbolic variable `x` in the MATLAB Workspace.

`p = poly2sym(c,var)` uses `var` as a polynomial variable when creating the symbolic polynomial expression `p` from the vector of coefficients `c`.

Examples

Create Polynomial Expression

Create a polynomial expression from a symbolic vector of coefficients. If you do not specify a polynomial variable, `poly2sym` uses `x`.

```
syms a b c d
p = poly2sym([a, b, c, d])
```

```
p =
a*x^3 + b*x^2 + c*x + d
```

Create a polynomial expression from a symbolic vector of rational coefficients.

```
p = poly2sym(sym([1/2, -1/3, 1/4]))
```

```
p =
x^2/2 - x/3 + 1/4
```

Create a polynomial expression from a numeric vector of floating-point coefficients. The toolbox converts floating-point coefficients to rational numbers before creating a polynomial expression.

```
p = poly2sym([0.75, -0.5, 0.25])
```

```
p =
(3*x^2)/4 - x/2 + 1/4
```

Specify Polynomial Variable

Create a polynomial expression from a symbolic vector of coefficients. Use `t` as a polynomial variable.

```
syms a b c d t
p = poly2sym([a, b, c, d], t)
```

```
p =
a*t^3 + b*t^2 + c*t + d
```

To use a symbolic expression, such as $t^2 + 1$ or $\exp(t)$, instead of a polynomial variable, substitute the variable using `subs`.

```
p1 = subs(p, t, t^2 + 1)
p2 = subs(p, t, exp(t))
```

```
p1 =
d + a*(t^2 + 1)^3 + b*(t^2 + 1)^2 + c*(t^2 + 1)
```

```
p2 =
d + c*exp(t) + a*exp(3*t) + b*exp(2*t)
```

Input Arguments

c — Polynomial coefficients

numeric vector | symbolic vector

Polynomial coefficients, specified as a numeric or symbolic vector. Argument `c` can be a column or row vector.

var — Polynomial variable

symbolic variable

Polynomial variable, specified as a symbolic variable.

Output Arguments

p — Polynomial

symbolic expression

Polynomial, returned as a symbolic expression.

Tips

- When you call `poly2sym` for a numeric vector `c`, the toolbox converts the numeric vector to a vector of symbolic numbers using the default (rational) conversion mode of `sym`.

See Also

`coeffs` | `sym` | `sym2poly`

Introduced before R2006a

polylog

Polylogarithm

Syntax

```
Li = polylog(n,x)
```

Description

`Li = polylog(n,x)` returns the polylogarithm of the order `n` and the argument `x`.

Examples

Polylogarithms of Numeric and Symbolic Arguments

`polylog` returns floating-point numbers or exact symbolic results depending on the arguments you use.

Compute the polylogarithms of numeric input arguments. The `polylog` function returns floating-point numbers.

```
Li = [polylog(3,-1/2), polylog(4,1/3), polylog(5,3/4)]
```

```
Li =
    -0.4726    0.3408    0.7697
```

Compute the polylogarithms of the same input arguments by converting them to symbolic objects. For most symbolic (exact) numbers, `polylog` returns unresolved symbolic calls.

```
symA = [polylog(3,sym(-1/2)), polylog(sym(4),1/3), polylog(5,sym(3/4))]
```

```
symA =
[ polylog(3, -1/2), polylog(4, 1/3), polylog(5, 3/4)]
```

Approximate the symbolic results with the default number of 32 significant digits by using `vpa`.

```
Li = vpa(symA)
```

```
Li =
[ -0.47259784465889687461862319312655,...
  0.3407911308562507524776409440122,...
  0.76973541059975738097269173152535]
```

The `polylog` function also accepts noninteger values of the order `n`. Compute `polylog` for complex arguments.

```
Li = polylog(-0.2i,2.5)
```

```
Li =
    -2.5030 + 0.3958i
```

Explicit Expressions for Polylogarithms

If the order of the polylogarithm is 0, 1, or a negative integer, then `polylog` returns an explicit expression.

The polylogarithm of $n = 1$ is a logarithmic function.

```
syms x
Li = polylog(1,x)
```

```
Li =
-log(1 - x)
```

The polylogarithms of $n < 1$ are rational expressions.

```
Li = polylog(0,x)
```

```
Li =
-x/(x - 1)
```

```
Li = polylog(-1,x)
```

```
Li =
x/(x - 1)^2
```

```
Li = polylog(-2,x)
```

```
Li =
-(x^2 + x)/(x - 1)^3
```

```
Li = polylog(-3,x)
```

```
Li =
(x^3 + 4*x^2 + x)/(x - 1)^4
```

```
Li = polylog(-10,x)
```

```
Li =
-(x^10 + 1013*x^9 + 47840*x^8 + 455192*x^7 + ...
1310354*x^6 + 1310354*x^5 + 455192*x^4 + ...
47840*x^3 + 1013*x^2 + x)/(x - 1)^11
```

Special Values

The `polylog` function has special values for some parameters.

If the second argument is 0, then the polylogarithm is equal to 0 for any integer value of the first argument. If the second argument is 1, then the polylogarithm is the Riemann zeta function of the first argument.

```
syms n
Li = [polylog(n,0), polylog(n,1)]
```

```
Li =
[ 0, zeta(n)]
```

If the second argument is -1, then the polylogarithm has a special value for any integer value of the first argument except 1.

```

assume(n ~= 1)
Li = polylog(n, -1)

Li =
zeta(n)*(2^(1 - n) - 1)

```

To do other computations, clear the assumption on n by recreating it using `syms`.

```
syms n
```

Compute other special values of the polylogarithm function.

```

Li = [polylog(4,sym(1)), polylog(sym(5),-1), polylog(2,sym(i))]

Li =
[ pi^4/90, -(15*zeta(5))/16, catalan*1i - pi^2/48]

```

Plot Polylogarithms

Plot the polylogarithms of the integer orders n from -3 to 1 within the interval $x = [-4 \ 0.3]$.

```

syms x
for n = -3:1
    fplot(polylog(n,x),[-4 0.3])
    hold on
end
title('Polylogarithm')
legend('show','Location','best')
hold off

```

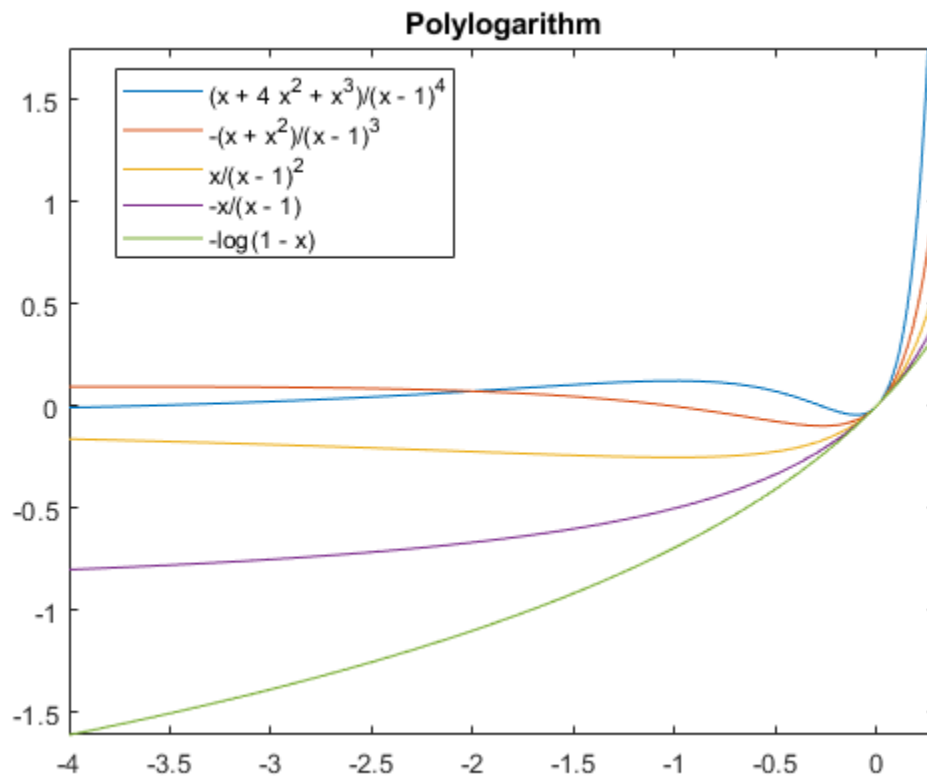

Handle Expressions Containing Polylogarithms

Many functions, such as `diff` and `int`, can handle expressions containing `polylog`.

Differentiate these expressions containing polylogarithms.

```
syms n x
dLi = diff(polylog(n, x), x)
dLi = diff(x*polylog(n, x), x)
```

```
dLi =
polylog(n - 1, x)/x
```

```
dLi =
polylog(n, x) + polylog(n - 1, x)
```

Compute the integrals of these expressions containing polylogarithms.

```
intLi = int(polylog(n, x)/x, x)
intLi = int(polylog(n, x) + polylog(n - 1, x), x)
```

```
intLi =
polylog(n + 1, x)
```

```
intLi =
x*polylog(n, x)
```

Input Arguments

n — Order of polylogarithm

number | array | symbolic number | symbolic variable | symbolic function | symbolic expression | symbolic array

Order of the polylogarithm, specified as a number, array, symbolic number, symbolic variable, symbolic function, symbolic expression, or symbolic array.

Data Types: `single` | `double` | `sym` | `symfun`

x — Argument of polylogarithm

number | array | symbolic number | symbolic variable | symbolic function | symbolic expression | symbolic array

Argument of the polylogarithm, specified as a number, array, symbolic number, symbolic variable, symbolic function, symbolic expression, or symbolic array.

Data Types: `single` | `double` | `sym` | `symfun`

More About

Polylogarithm

For a complex number z of modulus $|z| < 1$, the polylogarithm of order n is defined as:

$$\text{Li}_n(z) = \sum_{k=1}^{\infty} \frac{z^k}{k^n}.$$

Analytic continuation extends this function the whole complex plane, with a branch cut along the real interval $[1, \infty)$ for $n \geq 1$.

Tips

- `polylog(2, x)` is equivalent to `dilog(1 - x)`.
- The logarithmic integral function (the integral logarithm) uses the same notation, `li(x)`, but without an index. The toolbox provides the `logint` function to compute the logarithmic integral function.
- Floating-point evaluation of the polylogarithm function can be slow for complex arguments or high-precision numbers. To increase the computational speed, you can reduce the floating-point precision by using the `vpa` and `digits` functions. For more information, see “Increase Speed by Reducing Precision” on page 2-134.
- The polylogarithm function is related to other special functions. For example, it can be expressed in terms of the Hurwitz zeta function $\zeta(s, a)$ and the gamma function $\Gamma(z)$:

$$\text{Li}_n(z) = \frac{\Gamma(1-n)}{(2\pi)^{1-n}} \left[i^{1-n} \zeta\left(1-n, \frac{1}{2} + \frac{\ln(-z)}{2\pi i}\right) + i^{n-1} \zeta\left(1-n, \frac{1}{2} - \frac{\ln(-z)}{2\pi i}\right) \right].$$

Here, $n \neq 0, 1, 2, \dots$

References

- [1] Olver, F. W. J., A. B. Olde Daalhuis, D. W. Lozier, B. I. Schneider, R. F. Boisvert, C. W. Clark, B. R. Miller, and B. V. Saunders, eds., Chapter 25. Zeta and Related Functions, *NIST Digital Library of Mathematical Functions*, Release 1.0.20, Sept. 15, 2018.

See Also

`dilog` | `hurwitzZeta` | `log` | `logint` | `zeta`

Introduced in R2014b

polynomialDegree

Degree of polynomial

Syntax

```
polynomialDegree(p)
polynomialDegree(p,vars)
```

Description

`polynomialDegree(p)` returns the degree of polynomial p with respect to all variables found in p by `symvar`.

`polynomialDegree(p,vars)` returns the degree of p with respect to the variables in `vars`.

Examples

Degree of Polynomial

Find the degree of the polynomial $x^3 + x + 1$.

```
syms x
p = x^3 + x + 1;
deg = polynomialDegree(p)

deg =
     3
```

Degree of Multivariate Polynomial with Respect to Variable

Specify variables as the second argument of `polynomialDegree`. Find the degree of the polynomial $a^2x^3 + b^6x$ with the default independent variables found by `symvar`, the variable x , and the variables $[a \ x]$.

When using the default variables, the degree is 7 because, by default, a and b are variables. So the total degree of b^6x is 7.

```
syms a b x
p = a^2*x^3 + b^6*x;
deg = polynomialDegree(p) % uses symvar

deg =
     7
```

```
deg = polynomialDegree(p,x)
```

```
deg =
     3
```

```
vars = [a x];  
deg = polynomialDegree(p, vars)  
  
deg =  
    5
```

Input Arguments

p – Polynomial

symbolic expression | symbolic function

Polynomial, specified as a symbolic expression or function.

vars – Polynomial variables

vector of symbolic variables

Polynomial variables, specified as a vector of symbolic variables.

See Also

`coeffs` | `polynomialReduce`

Introduced in R2018a

polynomialReduce

Reduce polynomials by division

Syntax

```
r = polynomialReduce(p,d)
r = polynomialReduce(p,d,vars)
r = polynomialReduce( ___, 'MonomialOrder', MonomialOrder)
```

```
[r,q] = polynomialReduce( ___ )
```

Description

`r = polynomialReduce(p,d)` returns the “Polynomial Reduction” on page 4-1090 of `p` by `d` with respect to all variables in `p` determined by `symvar`. The input `d` can be a vector of polynomials.

`r = polynomialReduce(p,d,vars)` uses the polynomial variables in `vars`.

`r = polynomialReduce(___, 'MonomialOrder', MonomialOrder)` also uses the specified monomial order in addition to the input arguments in previous syntaxes. Options are 'degreeInverseLexicographic', 'degreeLexicographic', or 'lexicographic'. By default, `polynomialReduce` uses 'degreeInverseLexicographic'.

`[r,q] = polynomialReduce(___)` also returns the quotient in `q`.

Examples

Divide Two Polynomials

Find the quotient and remainder when $x^3 - x*y^2 + 1$ is divided by $x + y$.

```
syms x y
p = x^3 - x*y^2 + 1;
d = x + y;
[r,q] = polynomialReduce(p,d)
```

```
r =
1
q =
x^2 - y*x
```

Reconstruct the original polynomial from the quotient and remainder. Check that the reconstructed polynomial equals `p` by using `isAlways`.

```
pOrig = expand(sum(q.*d) + r);
isAlways(p == pOrig)
```

```
ans =  
  logical  
  1
```

Specify Polynomial Variables

Specify the polynomial variables as the second argument of `polynomialReduce`.

Divide $\exp(a)x^2 + 2xy + 1$ by $x - y$ with the polynomial variables $[x y]$, treating a as a symbolic parameter.

```
syms a x y  
p = exp(a)*x^2 + 2*x*y + 1;  
d = x - y;  
vars = [x y];  
r = polynomialReduce(p,d,vars)  
  
r =  
(exp(a) + 2)*y^2 + 1
```

Reduce Polynomial by Several Polynomials

Reduce $x^5 - x^2y^6 - xy$ by $x^2 + y$ and $x^2 - y^3$.

```
syms x y  
p = x^5 - x*y^6 - x*y;  
d = [x^2 + y, x^2 - y^3];  
[r,q] = polynomialReduce(p,d)  
  
r =  
-x*y  
q =  
[ x^3 - x*y^3, x*y^3 - x*y]
```

Reconstruct the original polynomial from the quotient and remainder. Check that the reconstructed polynomial equals p by using `isAlways`.

```
pOrig = expand(q*d.' + r);  
isAlways(p == pOrig)
```

```
ans =  
  logical  
  1
```

Specify Term Order of Polynomials

By default, `polynomialReduce` orders the terms in the polynomials with the term order `degreeInverseLexicographic`. Change the term order to `lexicographic` or `degreeLexicographic` by using the `'MonomialOrder'` name-value pair argument.

Divide two polynomials by using the `lexicographic` term order.

```
syms x y  
p = x^2 + y^3 + 1;
```

```
d = x - y^2;
r = polynomialReduce(p,d,'MonomialOrder','lexicographic')

r =
y^4 + y^3 + 1
```

Divide the same polynomials by using the `degreeLexicographic` term order.

```
r = polynomialReduce(p,d,'MonomialOrder','degreeLexicographic')

r =
x^2 + y*x + 1
```

Input Arguments

p — Polynomial to divide

symbolic expression | symbolic function

Polynomial to divide, specified as a symbolic expression or function.

d — Polynomials to divide by

symbolic expression or function | vector of symbolic expressions or functions

Polynomials to divide by, specified as a symbolic expression or function or a vector of symbolic expressions or functions.

vars — Polynomial variables

vector of symbolic variables

Polynomial variables, specified as a vector of symbolic variables.

MonomialOrder — Monomial order of divisors

'degreeInverseLexicographic' (default) | 'degreeLexicographic' | 'lexicographic'

Monomial order of divisors, specified as 'degreeInverseLexicographic', 'degreeLexicographic', or 'lexicographic'. If you specify `vars`, then `polynomialReduce` sorts variables based on the order of variables in `vars`.

- `lexicographic` sorts the terms of a polynomial using lexicographic ordering.
- `degreeLexicographic` sorts the terms of a polynomial according to the total degree of each term. If terms have equal total degrees, `polynomialReduce` sorts the terms using lexicographic ordering.
- `degreeInverseLexicographic` sorts the terms of a polynomial according to the total degree of each term. If terms have equal total degrees, `polynomialReduce` sorts the terms using inverse lexicographic ordering.

Output Arguments

r — Remainder of polynomial division

symbolic polynomial

Remainder of polynomial division, returned as a symbolic polynomial.

q — Quotient of polynomial division

symbolic polynomial | vector of symbolic polynomials

Quotient of polynomial division, returned as a symbolic polynomial or a vector of symbolic polynomials.

More About

Polynomial Reduction

Polynomial reduction is the division of the polynomial p by the divisor polynomials d_1, d_2, \dots, d_n . The terms of the divisor polynomials are ordered according to a certain term order. The quotients q_1, q_2, \dots, q_n and the remainder r satisfy this equation.

$$p = q_1d_1 + q_2d_2 + \dots + q_nd_n + r.$$

No term in r can be divided by the leading terms of any of the divisors d_1, d_2, \dots, d_n .

See Also

`eliminate` | `gbasis` | `polynomialDegree`

Introduced in R2018a

potential

Potential of vector field

Syntax

```
potential(V,X)
potential(V,X,Y)
```

Description

`potential(V,X)` computes the potential of the vector field V with respect to the vector X in Cartesian coordinates. The vector field V must be a gradient field.

`potential(V,X,Y)` computes the potential of vector field V with respect to X using Y as base point for the integration.

Examples

Compute Potential of Vector Field

Compute the potential of this vector field with respect to the vector $[x, y, z]$:

```
syms x y z
P = potential([x, y, z*exp(z)], [x y z])
```

```
P =
x^2/2 + y^2/2 + exp(z)*(z - 1)
```

Use the `gradient` function to verify the result:

```
simplify(gradient(P, [x y z]))
```

```
ans =
      x
      y
z*exp(z)
```

Specify Integration Base Point

Compute the potential of this vector field specifying the integration base point as $[0 \ 0 \ 0]$:

```
syms x y z
P = potential([x, y, z*exp(z)], [x y z], [0 0 0])
```

```
P =
x^2/2 + y^2/2 + exp(z)*(z - 1) + 1
```

Verify that $P([0 \ 0 \ 0]) = 0$:

```
subs(P, [x y z], [0 0 0])
```

```
ans =
0
```

Test Potential for Field Without Gradient

If a vector field is not gradient, `potential` returns NaN:

```
potential([x*y, y], [x y])
```

```
ans =
NaN
```

Input Arguments

V – Vector field

3-D symbolic vector of symbolic expressions or functions (default)

Vector field, specified as a 3-D vector of symbolic expressions or functions.

X – Input

vector of three symbolic variables

Input, specified as a vector of three symbolic variables with respect to which you compute the potential.

Y – Input

symbolic vector

Input, specified as a symbolic vector of variables, expressions, or numbers that you want to use as a base point for the integration. If you use this argument, `potential` returns $P(X)$ such that $P(Y) = 0$. Otherwise, the potential is only defined up to some additive constant.

More About

Scalar Potential of Gradient Vector Field

The potential of a gradient vector field $V(X) = [v_1(x_1, x_2, \dots), v_2(x_1, x_2, \dots), \dots]$ is the scalar $P(X)$ such that $V(X) = \nabla P(X)$.

The vector field is gradient if and only if the corresponding Jacobian is symmetrical:

$$\left(\frac{\partial v_i}{\partial x_j} \right) = \left(\frac{\partial v_j}{\partial x_i} \right)$$

The `potential` function represents the potential in its integral form:

$$P(X) = \int_0^1 (X - Y) \cdot V(Y + \lambda(X - Y)) d\lambda$$

Tips

- If `potential` cannot verify that V is a gradient field, it returns NaN.
- Returning NaN does not prove that V is not a gradient field. For performance reasons, `potential` sometimes does not sufficiently simplify partial derivatives, and therefore, it cannot verify that the field is gradient.

- If Y is a scalar, then `potential` expands it into a vector of the same length as X with all elements equal to Y .

See Also

`curl` | `diff` | `divergence` | `gradient` | `hessian` | `jacobian` | `laplacian` | `vectorPotential`

Introduced in R2012a

power, .^

Symbolic array power

Syntax

```
A.^B  
power(A,B)
```

Description

$A.^B$ computes A to the B power and is an elementwise operation.

`power(A,B)` is equivalent to $A.^B$.

Examples

Square Each Matrix Element

Create a 2-by-3 matrix.

```
A = sym('a', [2 3])
```

```
A =  
[ a1_1, a1_2, a1_3]  
[ a2_1, a2_2, a2_3]
```

Square each element of the matrix.

```
A.^2
```

```
ans =  
[ a1_1^2, a1_2^2, a1_3^2]  
[ a2_1^2, a2_2^2, a2_3^2]
```

Use Matrices for Base and Exponent

Create a 3-by-3 symbolic Hilbert matrix and a 3-by-3 diagonal matrix.

```
H = sym(hilb(3))  
d = diag(sym([1 2 3]))
```

```
H =  
[ 1, 1/2, 1/3]  
[ 1/2, 1/3, 1/4]  
[ 1/3, 1/4, 1/5]
```

```
d =  
[ 1, 0, 0]  
[ 0, 2, 0]  
[ 0, 0, 3]
```

Raise the elements of the Hilbert matrix to the powers of the diagonal matrix. The base and the exponent must be matrices of the same size.

```
H.^d
```

```
ans =  
[ 1, 1, 1]  
[ 1, 1/9, 1]  
[ 1, 1, 1/125]
```

Input Arguments

A — Input

number | symbolic number | symbolic variable | symbolic vector | symbolic matrix | symbolic multidimensional array | symbolic function | symbolic expression

Input, specified as a number or a symbolic number, variable, vector, matrix, multidimensional array, function, or expression. Inputs A and B must be the same size unless one is a scalar. A scalar value expands into an array of the same size as the other input.

B — Input

number | symbolic number | symbolic variable | symbolic vector | symbolic matrix | symbolic multidimensional array | symbolic function | symbolic expression

Input, specified as a number or a symbolic number, variable, vector, matrix, multidimensional array, function, or expression. Inputs A and B must be the same size unless one is a scalar. A scalar value expands into an array of the same size as the other input.

See Also

ctranspose | ldivide | minus | mldivide | mpower | mrdivide | mtimes | nthroot | plus | rdivide | times | transpose

Introduced before R2006a

powermod

Modular exponentiation

Syntax

```
c = powermod(a,b,m)
```

Description

`c = powermod(a,b,m)` returns the modular exponentiation $a^b \bmod m$. The input `a`, `b` must be integers, and `m` must be a nonnegative integer. For more information, see “Modular Exponentiation” on page 4-1097.

Examples

Compute Modular Exponentiation

Compute the modular exponentiation $a^b \bmod m$ by using `powermod`. The `powermod` function is efficient because it does not calculate the exponential a^b .

```
c = powermod(3,5,7)
```

```
c =  
    5
```

Prove Fermat's Little Theorem

Fermat's little theorem states that if p is prime and a is not divisible by p , then $a^{(p-1)} \bmod p$ is 1.

Test Fermat's little theorem for $p = 5$, $a = 3$. As expected, `powermod` returns 1.

```
p = 5;  
a = 3;  
c = powermod(a,p-1,p)
```

```
c =  
    1
```

Test the same case for all values of a less than p . The function `powermod` acts element-wise to return a vector of ones.

```
p = 5;  
a = 1:p-1;  
c = powermod(a,p-1,p)
```

```
c =  
    1    1    1    1
```

Compute Fermat Primes Using Fermat Primality Test

Fermat's little theorem states that if p is a prime number and a is not divisible by p , then $a^{(p-1)} \bmod p$ is 1. On the contrary, if $a^{(p-1)} \bmod p$ is 1 and a is not divisible by p , then p is not always a prime number (p can be a pseudoprime).

Test numbers from 300 to 400 for primality by using Fermat's little theorem with base 2.

```
p = 300:400;
remainder = powermod(2,p-1,p);
primesFermat = p(remainder == 1)

primesFermat =
    307    311    313    317    331    337    341    347    349    353...
    359    367    373    379    383    389    397
```

Find Fermat pseudoprimes by comparing the results with `isprime`. 341 is a Fermat pseudoprime.

```
primeNumbers = p(isprime(p));
setdiff(primesFermat,primeNumbers)

ans =
    341
```

Input Arguments

a — Base

number | vector | matrix | array | symbolic number | symbolic array

Base, specified as a number, vector, matrix, array, or a symbolic number or array. **a** must be an integer.

b — Exponent or power

number | vector | matrix | array | symbolic number | symbolic array

Exponent or power, specified as a number, vector, matrix, array, or a symbolic number or array. **b** must be an integer.

m — Divisor

number | vector | matrix | array | symbolic number | symbolic array

Divisor, specified as a number, vector, matrix, array, or a symbolic number or array. **m** must be a nonnegative integer.

More About

Modular Exponentiation

For a positive exponent b , the modular exponentiation c is defined as

$$c = a^b \bmod m.$$

For a negative exponent b , the definition can be extended by finding the modular multiplicative inverse d of a modulo m , that is

$$c = d^{-b} \bmod m.$$

where d satisfies the relation

$ad \bmod m = 1.$

See Also

`mod` | `nextprime` | `nthprime` | `prevprime`

Introduced in R2018a

pretty

Prettyprint symbolic expressions

Note `pretty` is not recommended. Use Live Scripts instead. Live Scripts provide full math rendering while `pretty` uses plain-text formatting. See “What Is a Live Script or Function?” (MATLAB)

Syntax

`pretty(X)`

Description

`pretty(X)` prints X in a plain-text format that resembles typeset mathematics. For true typeset rendering, use Live Scripts instead. See “What Is a Live Script or Function?” (MATLAB)

Examples

Pretty Print Symbolic Expressions

Pretty print symbolic expressions.

```
A = sym(pascal(2))
B = eig(A)
pretty(B)
```

```
A =
[ 1, 1]
[ 1, 2]
```

```
B =
```

```
3/2 - 5^(1/2)/2
5^(1/2)/2 + 3/2
```

```
/ 3    sqrt(5) \
| - - - - - |
| 2      2    |
|          |
| sqrt(5)  3  |
| - - - - - + - |
\      2      2 /
```

Pretty Print Long Expressions

Solve this equation, and then use `pretty` to represent the solutions in the format similar to typeset mathematics. For better readability, `pretty` uses abbreviations when representing long expressions.

```
syms x
s = solve(x^4 + 2*x + 1, x, 'MaxDegree',3);
pretty(s)
```

$$\left[\begin{array}{c} -1 \\ \sqrt[3]{\frac{1}{9} \sqrt[3]{2} + \frac{1}{3}} \\ \frac{1}{9 \sqrt[3]{2}} - \sqrt[3]{\frac{1}{2}} + \frac{1}{3} \\ \sqrt[3]{\frac{1}{9} \sqrt[3]{2} - \frac{1}{3}} + \sqrt[3]{\frac{1}{2}} + \frac{1}{3} \end{array} \right]$$

where

$$\#1 = \frac{\sqrt[3]{3} \left(\sqrt[3]{\frac{2}{9} \sqrt[3]{2} + \sqrt[3]{11}} \right)}{2}$$

$$\#2 = \sqrt[3]{\frac{\sqrt[3]{11} \sqrt[3]{27} - 17 \sqrt[3]{1}}{27}}$$

Introduced before R2006a

prevprime

Previous prime number

Syntax

```
prevprime(n)
```

Description

`prevprime(n)` returns the largest prime number smaller than or equal to n . If n is a vector or matrix, then `prevprime` acts element-wise on n .

Examples

Find Previous Prime Number

Find the largest prime number smaller than 100.

```
prevprime(100)
```

```
ans =
    97
```

Find the largest prime numbers smaller than 1000, 10000, and 100000 by specifying the input as a vector.

```
v = [1000 10000 100000];
prevprime(v)
```

```
ans =
    997    9973    99991
```

Find Large Prime Number

When finding large prime numbers, return exact symbolic integers by using symbolic input. Further, if your input has 15 or more digits, then use quotation marks and wrap the number in `sym` to represent the number accurately. For more information, see “Numeric to Symbolic Conversion” on page 2-136.

Find a large prime number by using $10^{\text{sym}(18)}$.

```
prevprime(10^sym(18))
```

```
ans =
99999999999999989
```

Find the prime number previous to 823572345728582545 by using quotation marks.

```
prevprime(sym('823572345728582545'))
```

```
ans =
823572345728582543
```

Input Arguments

n – Input

number | vector | matrix | array | symbolic number | symbolic array

Input, specified as a number, vector, matrix, array, or a symbolic number or array.

See Also

isprime | nextprime | nthprime | primes

Introduced in R2016b

psi

Digamma function

Syntax

```
psi(x)
psi(k,x)
```

Description

`psi(x)` computes the digamma function on page 4-1105 of x .

`psi(k,x)` computes the polygamma function on page 4-1105 of x , which is the k th derivative of the digamma function at x .

Examples

Compute Digamma and Polygamma for Numeric Inputs

Compute the digamma and polygamma functions for these numbers. Because these numbers are not symbolic objects, you get the floating-point results.

```
[psi(1/2) psi(2, 1/2) psi(1.34) psi(1, sin(pi/3))]
ans =
   -1.9635   -16.8288   -0.1248    2.0372
```

Compute Digamma and Polygamma for Symbolic Inputs

Compute the digamma and polygamma functions for the numbers converted to symbolic objects.

```
[psi(sym(1/2)), psi(1, sym(1/2)), psi(sym(1/4))]
ans =
[ - eulergamma - 2*log(2), pi^2/2, - eulergamma - pi/2 - 3*log(2)]
```

For some symbolic (exact) numbers, `psi` returns unresolved symbolic calls.

```
psi(sym(sqrt(2)))
ans =
psi(2^(1/2))
```

Compute Derivatives of Digamma and Polygamma Functions

Compute the derivatives of these expressions containing the digamma and polygamma functions.

```
syms x
diff(psi(1, x^3 + 1), x)
diff(psi(sin(x)), x)
ans =
3*x^2*psi(2, x^3 + 1)
```

```
ans =
cos(x)*psi(1, sin(x))
```

Expand Digamma and Polygamma Functions

Expand the expressions containing the digamma functions.

```
syms x
expand(psi(2*x + 3))
expand(psi(x + 2)*psi(x))

ans =
psi(x + 1/2)/2 + log(2) + psi(x)/2 +...
1/(2*x + 1) + 1/(2*x + 2) + 1/(2*x)

ans =
psi(x)/x + psi(x)^2 + psi(x)/(x + 1)
```

Limit of Digamma and Polygamma Functions

Compute the limits for expressions containing the digamma and polygamma functions.

```
syms x
limit(x*psi(x), x, 0)
limit(psi(3, x), x, inf)

ans =
-1

ans =
0
```

Compute Digamma for Matrix Input

Compute the digamma function for elements of matrix M and vector V .

```
M = sym([0 inf; 1/3 1/2]);
V = sym([1, inf]);
psi(M)
psi(V)

ans =
[
Inf, Inf]
[ -eulergamma - (3*log(3))/2 - (pi*3^(1/2))/6, -eulergamma - 2*log(2)]

ans =
[ -eulergamma, Inf]
```

Compute Polygamma for Matrix Input

Compute the polygamma function for elements of matrix M and vector V . The `psi` function acts elementwise on nonscalar inputs.

```
M = sym([0 inf; 1/3 1/2]);
polyGammaM = [1 3; 2 2];
V = sym([1, inf]);
polyGammaV = [6 6];
psi(polyGammaM, M)
psi(polyGammaV, V)
```

```
ans =
[
      Inf,      0]
[ -26*zeta(3) - (4*3^(1/2)*pi^3)/9, -14*zeta(3)]
```

```
ans =
[ -720*zeta(7), 0]
```

Because all elements of `polyGammaV` have the same value, you can replace `polyGammaV` by a scalar of that value. `psi` expands the scalar into a nonscalar of the same size as `V` and computes the result.

```
V = sym([1, inf]);
psi(6,V)
```

```
ans =
[ -720*zeta(7), 0]
```

Input Arguments

x — Input

symbolic number | symbolic variable | symbolic expression | symbolic array

Input, specified as a symbolic number, variable, expression, or array, or expression.

k — Input

nonnegative integer | nonnegative integer or vector, matrix or multidimensional array of nonnegative integers.

Input, specified as a nonnegative integer or vector, matrix or multidimensional array of nonnegative integers. If `x` is nonscalar and `k` is scalar, then `k` is expanded into a nonscalar of the same dimensions as `x` with each element being equal to `k`. If both `x` and `k` are nonscalars, they must have the same dimensions.

More About

Digamma Function

The digamma function is the first derivative of the logarithm of the gamma function:

$$\psi(x) = \frac{d}{dx} \ln \Gamma(x) = \frac{\Gamma'(x)}{\Gamma(x)}$$

Polygamma Function

The polygamma function of the order k is the $(k + 1)$ th derivative of the logarithm of the gamma function:

$$\psi^{(k)}(x) = \frac{d^{k+1}}{dx^{k+1}} \ln \Gamma(x) = \frac{d^k}{dx^k} \psi(x)$$

Tips

- Calling `psi` for a number that is not a symbolic object invokes the MATLAB `psi` function. This function accepts real nonnegative arguments `x`. If you want to compute the polygamma function for a complex number, use `sym` to convert that number to a symbolic object, and then call `psi` for that symbolic object.

- $\text{psi}(\theta, x)$ is equivalent to $\text{psi}(x)$.

See Also

beta | factorial | gamma | nchoosek

Introduced in R2011b

qr

QR factorization

Syntax

$R = \text{qr}(A)$

$[Q,R] = \text{qr}(A)$

$[Q,R,P] = \text{qr}(A)$

$[C,R] = \text{qr}(A,B)$

$[C,R,P] = \text{qr}(A,B)$

$[Q,R,p] = \text{qr}(A, \text{'vector'})$

$[C,R,p] = \text{qr}(A,B, \text{'vector'})$

$___ = \text{qr}(___, \text{'econ'})$

$___ = \text{qr}(___, \text{'real'})$

Description

$R = \text{qr}(A)$ returns the R part of the QR decomposition on page 4-1115 $A = Q^*R$. Here, A is an m -by- n matrix, R is an m -by- n upper triangular matrix, and Q is an m -by- m unitary matrix.

$[Q,R] = \text{qr}(A)$ returns an upper triangular matrix R and a unitary matrix Q , such that $A = Q^*R$.

$[Q,R,P] = \text{qr}(A)$ returns an upper triangular matrix R , a unitary matrix Q , and a permutation matrix P , such that $A^*P = Q^*R$. If all elements of A can be approximated by the floating-point numbers, then this syntax chooses the column permutation P so that $\text{abs}(\text{diag}(R))$ is decreasing. Otherwise, it returns $P = \text{eye}(n)$.

$[C,R] = \text{qr}(A,B)$ returns an upper triangular matrix R and a matrix C , such that $C = Q^*B$ and $A = Q^*R$. Here, A and B must have the same number of rows.

C and R represent the solution of the matrix equation $A^*X = B$ as $X = R \setminus C$.

$[C,R,P] = \text{qr}(A,B)$ returns an upper triangular matrix R , a matrix C , such that $C = Q^*B$, and a permutation matrix P , such that $A^*P = Q^*R$. If all elements of A can be approximated by the floating-point numbers, then this syntax chooses the permutation matrix P so that $\text{abs}(\text{diag}(R))$ is decreasing. Otherwise, it returns $P = \text{eye}(n)$. Here, A and B must have the same number of rows.

C , R , and P represent the solution of the matrix equation $A^*X = B$ as $X = P^*(R \setminus C)$.

$[Q,R,p] = \text{qr}(A, \text{'vector'})$ returns the permutation information as a vector p , such that $A(:,p) = Q^*R$.

$[C,R,p] = \text{qr}(A,B, \text{'vector'})$ returns the permutation information as a vector p .

C , R , and p represent the solution of the matrix equation $A^*X = B$ as $X(p,:) = R \setminus C$.

`___ = qr(___, 'econ')` returns the "economy size" decomposition. If A is an m -by- n matrix with $m > n$, then `qr` computes only the first n columns of Q and the first n rows of R . For $m \leq n$, the syntaxes with 'econ' are equivalent to the corresponding syntaxes without 'econ'.

When you use 'econ', `qr` always returns the permutation information as a vector p .

You can use `0` instead of 'econ'. For example, `[Q,R] = qr(A,0)` is equivalent to `[Q,R] = qr(A,'econ')`.

`___ = qr(___, 'real')` assumes that input arguments and intermediate results are real, and therefore, suppresses calls to `abs` and `conj`. When you use this flag, `qr` assumes that all symbolic variables represent real numbers. When using this flag, ensure that all numeric arguments are real numbers.

Use 'real' to avoid complex conjugates in the result.

Examples

R part of QR Factorization

Compute the R part of the QR decomposition of the 4-by-4 Wilkinson's eigenvalue test matrix.

Create the 4-by-4 Wilkinson's eigenvalue test matrix:

```
A = sym(wilkinson(4))
```

```
A =
[ 3/2, 1, 0, 0]
[ 1, 1/2, 1, 0]
[ 0, 1, 1/2, 1]
[ 0, 0, 1, 3/2]
```

Use the syntax with one output argument to return the R part of the QR decomposition without returning the Q part:

```
R = qr(A)
```

```
R =
[ 13^(1/2)/2, (4*13^(1/2))/13, (2*13^(1/2))/13, 0]
[ 0, (13^(1/2)*53^(1/2))/26, (10*13^(1/2)*53^(1/2))/689, (2*13^(1/2)*53^(1/2))/53]
[ 0, 0, (53^(1/2)*381^(1/2))/106, (172*53^(1/2)*381^(1/2))/20193]
[ 0, 0, 0, (35*381^(1/2))/762]
```

QR Factorization of Pascal Matrix

Compute the QR decomposition of the 3-by-3 Pascal matrix.

Create the 3-by-3 Pascal matrix:

```
A = sym(pascal(3))
```

```
A =
[ 1, 1, 1]
[ 1, 2, 3]
[ 1, 3, 6]
```

Find the Q and R matrices representing the QR decomposition of A :

```
[Q,R] = qr(A)
```

```

Q =
[ 3^(1/2)/3, -2^(1/2)/2, 6^(1/2)/6]
[ 3^(1/2)/3, 0, -6^(1/2)/3]
[ 3^(1/2)/3, 2^(1/2)/2, 6^(1/2)/6]

R =
[ 3^(1/2), 2*3^(1/2), (10*3^(1/2))/3]
[ 0, 2^(1/2), (5*2^(1/2))/2]
[ 0, 0, 6^(1/2)/6]

```

Verify that $A = Q*R$ using `isAlways`:

```
isAlways(A == Q*R)
```

```

ans =
 3x3 logical array
 1 1 1
 1 1 1
 1 1 1

```

Permutation Information

Using permutations helps increase numerical stability of the QR factorization for floating-point matrices. The `qr` function returns permutation information either as a matrix or as a vector.

Set the number of significant decimal digits, used for variable-precision arithmetic, to 10. Approximate the 3-by-3 symbolic Hilbert matrix by floating-point numbers:

```

previoussetting = digits(10);
A = vpa(hilb(3))

A =
[ 1.0, 0.5, 0.3333333333]
[ 0.5, 0.3333333333, 0.25]
[ 0.3333333333, 0.25, 0.2]

```

First, compute the QR decomposition of A without permutations:

```

[Q,R] = qr(A)

Q =
[ 0.8571428571, -0.5016049166, 0.1170411472]
[ 0.4285714286, 0.5684855721, -0.7022468832]
[ 0.2857142857, 0.6520863915, 0.7022468832]

R =
[ 1.166666667, 0.6428571429, 0.45]
[ 0, 0.1017143303, 0.1053370325]
[ 0, 0, 0.003901371573]

```

Compute the difference between A and $Q*R$. The computed Q and R matrices do not strictly satisfy the equality $A*P = Q*R$ because of the round-off errors.

```
A - Q*R
```

```

ans =
[-1.387778781e-16, -3.989863995e-16, -2.064320936e-16]
[-3.469446952e-18, -8.847089727e-17, -1.084202172e-16]
[-2.602085214e-18, -6.591949209e-17, -6.678685383e-17]

```

To increase numerical stability of the QR decomposition, use permutations by specifying the syntax with three output arguments. For matrices that do not contain symbolic variables, expressions, or functions, this syntax triggers pivoting, so that $\text{abs}(\text{diag}(R))$ in the returned matrix R is decreasing.

```
[Q,R,P] = qr(A)

Q =
[ 0.8571428571, -0.4969293466, -0.1355261854]
[ 0.4285714286,  0.5421047417,  0.7228063223]
[ 0.2857142857,  0.6776309272, -0.6776309272]
R =
[ 1.166666667,      0.45,    0.6428571429]
[      0, 0.1054092553,    0.1016446391]
[      0,      0,    0.003764616262]
P =
     1     0     0
     0     0     1
     0     1     0
```

Check the equality $A*P = Q*R$ again. QR factorization with permutations results in smaller round-off errors.

```
A*P - Q*R

ans =
[ -3.469446952e-18, -4.33680869e-18, -6.938893904e-18]
[      0, -8.67361738e-19, -1.734723476e-18]
[      0, -4.33680869e-19, -1.734723476e-18]
```

Now, return the permutation information as a vector by using the 'vector' argument:

```
[Q,R,p] = qr(A,'vector')

Q =
[ 0.8571428571, -0.4969293466, -0.1355261854]
[ 0.4285714286,  0.5421047417,  0.7228063223]
[ 0.2857142857,  0.6776309272, -0.6776309272]
R =
[ 1.166666667,      0.45,    0.6428571429]
[      0, 0.1054092553,    0.1016446391]
[      0,      0,    0.003764616262]
p =
     1     3     2
```

Verify that $A(:,p) = Q*R$:

```
A(:,p) - Q*R

ans =
[ -3.469446952e-18, -4.33680869e-18, -6.938893904e-18]
[      0, -8.67361738e-19, -1.734723476e-18]
[      0, -4.33680869e-19, -1.734723476e-18]
```

Exact symbolic computations let you avoid roundoff errors:

```
A = sym(hilb(3));
[Q,R] = qr(A);
A - Q*R
```

```
ans =
[ 0, 0, 0]
[ 0, 0, 0]
[ 0, 0, 0]
```

Restore the number of significant decimal digits to its default setting:

```
digits(previoussetting)
```

Use QR Decomposition to Solve Matrix Equation

You can use `qr` to solve systems of equations in a matrix form.

Suppose you need to solve the system of equations $A*X = b$, where A and b are the following matrix and vector:

```
A = sym(invhilb(5))
b = sym([1:5]')
```

```
A =
[ 25, -300, 1050, -1400, 630]
[ -300, 4800, -18900, 26880, -12600]
[ 1050, -18900, 79380, -117600, 56700]
[ -1400, 26880, -117600, 179200, -88200]
[ 630, -12600, 56700, -88200, 44100]
b =
```

```
1
2
3
4
5
```

Use `qr` to find matrices C and R , such that $C = Q'*B$ and $A = Q*R$:

```
[C,R] = qr(A,b);
```

Compute the solution X :

```
X = R\C
```

```
X =
      5
    71/20
   197/70
   657/280
  1271/630
```

Verify that X is the solution of the system $A*X = b$ using `isAlways`:

```
isAlways(A*X == b)
```

```
ans =
5x1 logical array
1
1
1
1
1
```

Use QR Decomposition with Permutation Information to Solve Matrix Equation

When solving systems of equations that contain floating-point numbers, use QR decomposition with the permutation matrix or vector.

Suppose you need to solve the system of equations $A \cdot X = b$, where A and b are the following matrix and vector:

```
previoussetting = digits(10);
A = vpa([2 -3 -1; 1 1 -1; 0 1 -1]);
b = vpa([2; 0; -1]);
```

Use `qr` to find matrices C and R , such that $C = Q' \cdot B$ and $A = Q \cdot R$:

```
[C,R,P] = qr(A,b)

C =
-2.110579412
-0.2132007164
0.7071067812
R =
[ 3.31662479, 0.3015113446, -1.507556723]
[          0, 1.705605731, -1.492405014]
[          0,          0, 0.7071067812]
P =
     0     0     1
     1     0     0
     0     1     0
```

Compute the solution X :

```
X = P*(R\C)
```

```
X =
    1.0
   -0.25
    0.75
```

Alternatively, return the permutation information as a vector:

```
[C,R,p] = qr(A,b,'vector')

C =
-2.110579412
-0.2132007164
0.7071067812
R =
[ 3.31662479, 0.3015113446, -1.507556723]
[          0, 1.705605731, -1.492405014]
[          0,          0, 0.7071067812]
p =
     2     3     1
```

In this case, compute the solution X as follows:

```
X(p,:) = R\C

X =
    1.0
```

```
-0.25
0.75
```

Restore the number of significant decimal digits to its default setting:

```
digits(previoussetting)
```

"Economy Size" Decomposition

Use 'econ' to compute the "economy size" QR decomposition.

Create a matrix that consists of the first two columns of the 4-by-4 Pascal matrix:

```
A = sym(pascal(4));
A = A(:,1:2)
```

```
A =
[ 1, 1]
[ 1, 2]
[ 1, 3]
[ 1, 4]
```

Compute the QR decomposition for this matrix:

```
[Q,R] = qr(A)
```

```
Q =
[ 1/2, -(3*5^(1/2))/10, (3^(1/2)*10^(1/2))/10, 0]
[ 1/2, -5^(1/2)/10, -(2*3^(1/2)*10^(1/2))/15, 6^(1/2)/6]
[ 1/2, 5^(1/2)/10, -(3^(1/2)*10^(1/2))/30, -6^(1/2)/3]
[ 1/2, (3*5^(1/2))/10, (3^(1/2)*10^(1/2))/15, 6^(1/2)/6]
```

```
R =
[ 2, 5]
[ 0, 5^(1/2)]
[ 0, 0]
[ 0, 0]
```

Now, compute the "economy size" QR decomposition for this matrix. Because the number of rows exceeds the number of columns, qr computes only the first 2 columns of Q and the first 2 rows of R.

```
[Q,R] = qr(A,'econ')
```

```
Q =
[ 1/2, -(3*5^(1/2))/10]
[ 1/2, -5^(1/2)/10]
[ 1/2, 5^(1/2)/10]
[ 1/2, (3*5^(1/2))/10]
```

```
R =
[ 2, 5]
[ 0, 5^(1/2)]
```

Avoid Complex Conjugates

Use the 'real' flag to avoid complex conjugates in the result.

Create a matrix, one of the elements of which is a variable:

```
syms x
A = [1 2; 3 x]
```

```
A =
[ 1, 2]
[ 3, x]
```

Compute the QR factorization of this matrix. By default, `qr` assumes that `x` represents a complex number, and therefore, the result contains expressions with the `abs` function.

```
[Q,R] = qr(A)
```

```
Q =
[ 10^(1/2)/10, -((3*x)/10 - 9/5)/(abs(x/10 - 3/5)^2...
+ abs((3*x)/10 - 9/5)^2)^(1/2)]
[ (3*10^(1/2))/10, (x/10 - 3/5)/(abs(x/10 - 3/5)^2...
+ abs((3*x)/10 - 9/5)^2)^(1/2)]
```

```
R =
[ 10^(1/2), (10^(1/2)*(3*x + 2))/10]
[ 0, (abs(x/10 - 3/5)^2 + abs((3*x)/10 - 9/5)^2)^(1/2)]
```

When you use `'real'`, `qr` assumes that all symbolic variables represent real numbers, and can return shorter results:

```
[Q,R] = qr(A,'real')
```

```
Q =
[ 10^(1/2)/10, -((3*x)/10 - 9/5)/(x^2/10 - (6*x)/5...
+ 18/5)^(1/2)]
[ (3*10^(1/2))/10, (x/10 - 3/5)/(x^2/10 - (6*x)/5...
+ 18/5)^(1/2)]
```

```
R =
[ 10^(1/2), (10^(1/2)*(3*x + 2))/10]
[ 0, (x^2/10 - (6*x)/5 + 18/5)^(1/2)]
```

Input Arguments

A — Input matrix

m-by-*n* symbolic matrix

Input matrix, specified as an *m*-by-*n* symbolic matrix.

B — Input

symbolic vector | symbolic matrix

Input, specified as a symbolic vector or matrix. The number of rows in `B` must be the same as the number of rows in `A`.

Output Arguments

R — R part of the QR decomposition

m-by-*n* upper triangular symbolic matrix

R part of the QR decomposition, returned as an *m*-by-*n* upper triangular symbolic matrix.

Q – Q part of the QR decomposition*m-by-m* unitary symbolic matrix

Q part of the QR decomposition, returned as an *m-by-m* unitary symbolic matrix.

P – Permutation information

matrix of double-precision values

Permutation information, returned as a matrix of double-precision values, such that $A * P = Q * R$.

p – Permutation information

vector of double-precision values

Permutation information, returned as a vector of double-precision values, such that $A(:, p) = Q * R$.

C – Matrix representing solution of matrix equation $A * X = B$

symbolic matrix

Matrix representing solution of matrix equation $A * X = B$, returned as a symbolic matrix, such that $C = Q' * B$.

More About**QR Factorization of Matrix**

The QR factorization expresses an *m-by-n* matrix *A* as $A = Q * R$. Here, *Q* is an *m-by-m* unitary matrix, and *R* is an *m-by-n* upper triangular matrix. If the components of *A* are real numbers, then *Q* is an orthogonal matrix.

Tips

- The upper triangular matrix *R* satisfies the following condition: $R = \text{chol}(A' * A)$.
- The arguments 'econ' and 0 only affect the shape of the returned matrices.
- Calling `qr` for numeric matrices that are not symbolic objects (not created by `sym`, `syms`, or `vpa`) invokes the MATLAB `qr` function.
- If you use 'matrix' instead of 'vector', then `qr` returns permutation matrices, as it does by default. If you use 'matrix' and 'econ', then `qr` throws an error.
- Matrix computations involving many symbolic variables can be slow. To increase the computational speed, reduce the number of symbolic variables by substituting the given values for some variables.

See Also`chol` | `eig` | `lu` | `svd`**Introduced in R2014a**

quorem

Quotient and remainder

Syntax

```
[Q,R] = quorem(A,B,var)
[Q,R] = quorem(A,B)
```

Description

`[Q,R] = quorem(A,B,var)` divides A by B and returns the quotient Q and remainder R of the division, such that $A = Q*B + R$. This syntax regards A and B as polynomials in the variable var .

If A and B are matrices, `quorem` performs elements-wise division, using var as a variable. It returns the quotient Q and remainder R of the division, such that $A = Q.*B + R$.

`[Q,R] = quorem(A,B)` uses the variable determined by `symvar(A,1)`. If `symvar(A,1)` returns an empty symbolic object `sym([])`, then `quorem` uses the variable determined by `symvar(B,1)`.

If both `symvar(A,1)` and `symvar(B,1)` are empty, then A and B must both be integers or matrices with integer elements. In this case, `quorem(A,B)` returns symbolic integers Q and R , such that $A = Q*B + R$. If A and B are matrices, then Q and R are symbolic matrices with integer elements, such that $A = Q.*B + R$, and each element of R is smaller in absolute value than the corresponding element of B .

Examples

Divide Multivariate Polynomials

Compute the quotient and remainder of the division of these multivariate polynomials with respect to the variable y :

```
syms x y
p1 = x^3*y^4 - 2*x*y + 5*x + 1;
p2 = x*y;
[q, r] = quorem(p1, p2, y)
```

```
q =
x^2*y^3 - 2
```

```
r =
5*x + 1
```

Divide Univariate Polynomials

Compute the quotient and remainder of the division of these univariate polynomials:

```
syms x
p = x^3 - 2*x + 5;
[q, r] = quorem(x^5, p)
```

```
q =
x^2 + 2
```

```
r =
- 5*x^2 + 4*x - 10
```

Divide Integers

Compute the quotient and remainder of the division of these integers:

```
[q, r] = quorem(sym(10)^5, sym(985))
```

```
q =
101
```

```
r =
515
```

Input Arguments

A — Dividend (numerator)

symbolic integer | polynomial | symbolic vector | symbolic matrix

Dividend (numerator), specified as a symbolic integer, polynomial, or a vector or matrix of symbolic integers or polynomials.

B — Divisor (denominator)

symbolic integer | polynomial | symbolic vector | symbolic matrix

Divisor (denominator), specified as a symbolic integer, polynomial, or a vector or matrix of symbolic integers or polynomials.

var — Polynomial variable

symbolic variable

Polynomial variable, specified as a symbolic variable.

Output Arguments

Q — Quotient of the division

symbolic integer | symbolic expression | symbolic vector | symbolic matrix

Quotient of the division, returned as a symbolic integer, expression, or a vector or matrix of symbolic integers or expressions.

R — Remainder of the division

symbolic integer | symbolic expression | symbolic vector | symbolic matrix

Remainder of the division, returned as a symbolic integer, expression, or a vector or matrix of symbolic integers or expressions.

See Also

deconv | mod

Introduced before R2006a

rank

Find rank of symbolic matrix

Syntax

rank(A)

Description

rank(A) returns the rank of symbolic matrix A.

Examples

Find Rank of Matrix

```
syms a b c d
A = [a b; c d];
rank(A)
```

```
ans =
     2
```

Rank of Symbolic Matrices Is Exact

Symbolic calculations return the exact rank of a matrix while numeric calculations can suffer from round-off errors. This exact calculation is useful for ill-conditioned matrices, such as the Hilbert matrix. The rank of a Hilbert matrix of order n is n .

Find the rank of the Hilbert matrix of order 15 numerically. Then convert the numeric matrix to a symbolic matrix using `sym` and find the rank symbolically.

```
H = hilb(15);
rank(H)
rank(sym(H))
```

```
ans =
    12
ans =
    15
```

The symbolic calculation returns the correct rank of 15. The numeric calculation returns an incorrect rank of 12 due to round-off errors.

Rank Function Does Not Simplify Symbolic Calculations

Consider this matrix

$$A = \begin{bmatrix} 1 - \sin^2(x) & \cos^2(x) \\ 1 & 1 \end{bmatrix}.$$

After simplification of $1 - \sin(x)^2$ to $\cos(x)^2$, the matrix has a rank of 1. However, `rank` returns an incorrect rank of 2 because it does not take into account identities satisfied by special functions occurring in the matrix elements. Demonstrate the incorrect result.

```
syms x
A = [1-sin(x) cos(x); cos(x) 1+sin(x)];
rank(A)

ans =
     2
```

`rank` returns an incorrect result because the outputs of intermediate steps are not simplified. While there is no fail-safe workaround, you can simplify symbolic expressions by using numeric substitution and evaluating the substitution using `vpa`.

Find the correct rank by substituting `x` with a number and evaluating the result using `vpa`.

```
rank(vpa(subs(A,x,1)))

ans =
     1
```

However, even after numeric substitution, `rank` can return incorrect results due to round-off errors.

Input Arguments

A — Input

number | vector | matrix | symbolic number | symbolic vector | symbolic matrix

Input, specified as a number, vector, or matrix or a symbolic number, vector, or matrix.

See Also

`eig` | `null` | `rref`

Introduced before R2006a

rat

Rational fraction approximation (continued fraction)

Syntax

```
R = rat(X)
R = rat(X,tol)

[N,D] = rat( ___ )
___ = rat( ___ ,Name,Value)
```

Description

`R = rat(X)` returns the rational fraction approximation of `X` to within the default tolerance, $1.e-6*\text{norm}(X(:),1)$. The approximation is a character array containing the simple continued fraction on page 4-1126 with finite terms.

`R = rat(X,tol)` approximates `X` to within the tolerance, `tol`.

`[N,D] = rat(___)` returns two arrays, `N` and `D`, such that `N./D` approximates `X`. You can use this output syntax with any of the previous input syntaxes.

`___ = rat(___ ,Name,Value)` uses additional options specified by one or more `Name,Value` pair arguments to approximate `X`.

Examples

Find Rational Approximation of Irrational Number

Declare the irrational number $\sqrt{3}$ as a symbolic number.

```
X = sqrt(sym(3))
```

```
X =  $\sqrt{3}$ 
```

Find the rational fraction approximation (truncated continued fraction) of this number. The resulting expression is a character vector.

```
R = rat(X)
```

```
R =
'2 + 1/(-4 + 1/(4 + 1/(-4 + 1/(4 + 1/(-4)))))'
```

Display the symbolic formula from the character vector `R`.

```
displayFormula(['A rational approximation of X is'; R])
```

```
A rational approximation of X is
```

$$2 + \frac{1}{-4 + \frac{1}{4 + \frac{1}{-4 + \frac{1}{4 + \frac{1}{-4}}}}}$$

Approximate Value of π with Different Precision

Represent the mathematical quantity π as a symbolic constant. The constant π is an irrational number.

```
X = sym(pi)
```

```
X =  $\pi$ 
```

Use `vpa` to show the decimal representation of π with 12 significant digits.

```
Xdec = vpa(X,12)
```

```
Xdec = 3.14159265359
```

Find the rational fraction approximation of π using the `rat` function with default tolerance. The resulting expression is a character vector.

```
R = rat(sym(pi))
```

```
R =  
'3 + 1/(7 + 1/(16))'
```

Use `str2sym` to turn the character vector into a single fractional number.

```
Q = str2sym(R)
```

```
Q =  
 $\frac{355}{113}$ 
```

Show the decimal representation of the fractional number 355/113. This approximation agrees with π to 6 decimal places.

```
Qdec = vpa(Q,12)
```

```
Qdec = 3.14159292035
```

You can specify a tolerance for additional accuracy in the approximation.

```
R = rat(sym(pi),1e-8)
```

```
R =  
'3 + 1/(7 + 1/(16 + 1/(-294)))'
```

```
Q = str2sym(R)
```

```
Q =  
 $\frac{104348}{33215}$ 
```

The resulting approximation, 104348/33215, agrees with π to 9 decimal places.

```
Qdec = vpa(Q,12)
```

```
Qdec = 3.14159265392
```

Approximate Solution of Equation

Solve the equation $\cos(x) + x^2 + x = 42$ using `vpsolve`. The solution is returned in decimal representation.

```
syms x
```

```
sol = vpsolve(cos(x) + x^2 + x == 42)
```

```
sol = 5.9274875551262136192212919837749
```

Approximate the solution as a continued fraction.

```
R = rat(sol)
```

```
R =
```

```
'6 + 1/(-14 + 1/(5 + 1/(-5)))'
```

To extract the coefficients in the denominator of the continued fraction, you can use the `regexp` function and convert them to a character array.

```
S = char(regexp(R, '(-*\d+)', 'match'))
```

```
S = 3x4 char array
```

```
'(-14'
```

```
'(5 '
```

```
'(-5 '
```

Return the result as a symbolic array.

```
coeffs = sym(S(:,2:end))
```

```
coeffs =
```

$$\begin{pmatrix} -14 \\ 5 \\ -5 \end{pmatrix}$$

Use `str2sym` to turn the continued fraction `R` into a single fractional number.

```
Q = str2sym(R)
```

```
Q =
```

$$\frac{1962}{331}$$

You can also return the numerator and denominator of the rational approximation by specifying two output arguments for the `rat` function.

```
[N,D] = rat(sol)
```

```
N = 1962
```

```
D = 331
```

Find Rational Approximation of Golden Ratio

Define the golden ratio $X = (1 + \sqrt{5})/2$ as a symbolic number.

```
X = (sym(1) + sqrt(5))/ 2
```

```
X =

$$\frac{\sqrt{5}}{2} + \frac{1}{2}$$

```

Find the rational approximation of X within a tolerance of $1e-4$.

```
R = rat(X,1e-4)
```

```
R =
'2 + 1/(-3 + 1/(3 + 1/(-3 + 1/(3 + 1/(-3)))))'
```

To return the rational approximation with 10 coefficients, set the 'Length' option to 10. This option ignores the specified tolerance in the approximation.

```
R10 = rat(X,1e-4, 'Length', 10)
```

```
R10 =
'2 + 1/(-3 + 1/(3 + 1/(-3 + 1/(3 + 1/(-3 + 1/(3 + 1/(-3 + 1/(3 + 1/(-3))))))))''
```

To return the rational approximation with all positive coefficients, set the 'Positive' option to true.

```
Rpos = rat(X,1e-4, 'Positive', true)
```

```
Rpos =
'1 + 1/(1 + 1/(1 + 1/(1 + 1/(1 + 1/(1 + 1/(1 + 1/(1 + 1/(1 + 1/(1))))))))''
```

Input Arguments

X — Input

number | vector | matrix | array | symbolic number | symbolic array

Input, specified as a number, vector, matrix, array, symbolic number, or symbolic array.

Data Types: single | double | sym

Complex Number Support: Yes

tol — Tolerance

scalar

Tolerance, specified as a scalar. N and D approximate X , such that $N./D - X < tol$. The default tolerance is $1e-6 * \text{norm}(X(:), 1)$.

Name-Value Pair Arguments

Specify optional comma-separated pairs of `Name`, `Value` arguments. `Name` is the argument name and `Value` is the corresponding value. `Name` must appear inside quotes. You can specify several name and value pair arguments in any order as `Name1, Value1, ..., NameN, ValueN`.

Example: `'Length',5,'Positive',true`

Length — Number of coefficients

positive integer

Number of coefficients or terms of the continued fraction, specified as a positive integer. Specifying this option overrides the tolerance argument `tol`.

Example: 5

Positive — Option to return positive coefficients

logical 0 (false) (default) | logical value

Option to return positive coefficients, specified as a logical value (boolean). If you specify `true`, then `rat` returns a regular continued fraction expansion with all positive integers in the denominator.

Example: `true`

Output Arguments

R — Continued fraction

character array

Continued fraction, returned as a character array.

- If `X` is an array of m elements and all elements are real numbers, then `R` is returned as a character array with m rows.
- If `X` is an array of m elements that contains a complex number, then `R` is returned as a character array with $2m+1$ rows. The first m rows of `R` represent the continued fraction expansion of the real parts of `X`, followed by `' +i* ... '` in the $(m+1)$ -th row, and the last m rows represent the continued fraction expansions of the imaginary parts of `X`.

N — Numerator

number | vector | matrix | array | symbolic number | symbolic array

Numerator, returned as a number, vector, matrix, array, symbolic number, or symbolic array. `N./D` approximates `X`.

D — Denominator

number | vector | matrix | array | symbolic number | symbolic array

Denominator, returned as a number, vector, matrix, array, symbolic number, or symbolic array. `N./D` approximates `X`.

Limitations

- You can only specify the `Name`, `Value` arguments, such as `'Length',5,'Positive',true`, if the array `X` contains a symbolic number or the data type of `X` is `sym`.

More About

Simple Continued Fraction

The `rat` function approximates each element of X by a simple continued fraction of the form

$$R = \frac{N}{D} = a_1 + \frac{1}{a_2 + \frac{1}{\ddots + \frac{1}{a_k}}}$$

with a finite number of integer terms a_1, a_2, \dots, a_k . The accuracy of the rational approximation increases with the number of terms.

See Also

`format` | `vpa` | `sym`

Introduced in R2020a

rdivide, ./

Symbolic array right division

Syntax

```
A./B
rdivide(A,B)
```

Description

A./B divides A by B.

rdivide(A,B) is equivalent to A./B.

Examples

Divide Scalar by Matrix

Create a 2-by-3 matrix.

```
B = sym('b', [2 3])
```

```
B =
[ b1_1, b1_2, b1_3]
[ b2_1, b2_2, b2_3]
```

Divide the symbolic expression `sin(a)` by each element of the matrix B.

```
syms a
sin(a)./B
```

```
ans =
[ sin(a)/b1_1, sin(a)/b1_2, sin(a)/b1_3]
[ sin(a)/b2_1, sin(a)/b2_2, sin(a)/b2_3]
```

Divide Matrix by Matrix

Create a 3-by-3 symbolic Hilbert matrix and a 3-by-3 diagonal matrix.

```
H = sym(hilb(3))
d = diag(sym([1 2 3]))
```

```
H =
[ 1, 1/2, 1/3]
[ 1/2, 1/3, 1/4]
[ 1/3, 1/4, 1/5]
```

```
d =
[ 1, 0, 0]
[ 0, 2, 0]
[ 0, 0, 3]
```

Divide d by H by using the elementwise right division operator `./`. This operator divides each element of the first matrix by the corresponding element of the second matrix. The dimensions of the matrices must be the same.

```
d./H  
  
ans =  
[ 1, 0, 0]  
[ 0, 6, 0]  
[ 0, 0, 15]
```

Divide Expression by Symbolic Function

Divide a symbolic expression by a symbolic function. The result is a symbolic function.

```
syms f(x)  
f(x) = x^2;  
f1 = (x^2 + 5*x + 6)./f  
  
f1(x) =  
(x^2 + 5*x + 6)/x^2
```

Input Arguments

A — Input

symbolic variable | symbolic vector | symbolic matrix | symbolic multidimensional array | symbolic function | symbolic expression

Input, specified as a symbolic variable, vector, matrix, multidimensional array, function, or expression. Inputs A and B must be the same size unless one is a scalar. A scalar value expands into an array of the same size as the other input.

B — Input

symbolic variable | symbolic vector | symbolic matrix | symbolic multidimensional array | symbolic function | symbolic expression

Input, specified as a symbolic variable, vector, matrix, multidimensional array, function, or expression. Inputs A and B must be the same size unless one is a scalar. A scalar value expands into an array of the same size as the other input.

See Also

`ctranspose` | `ldivide` | `minus` | `mldivide` | `mpower` | `mrdivide` | `mtimes` | `plus` | `power` | `times` | `transpose`

Introduced before R2006a

read

(Not recommended) Read MuPAD program file into symbolic engine

Note `read(symengine,...)` is not recommended. Use equivalent Symbolic Math Toolbox™ functions that replace MuPAD® functions instead. For more information, see “Compatibility Considerations”.

Syntax

`read(symengine, filename)`

Description

`read(symengine, filename)` reads the MuPAD program file `filename` into the symbolic engine. Reading a program file means finding and executing it.

Examples

Read MuPAD Program File into Symbolic Engine

Suppose you wrote the MuPAD procedure `myProc` and saved it in the file `myProcedure.mu`.

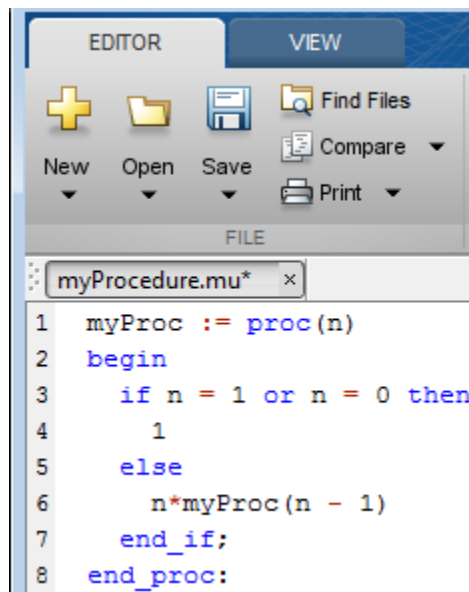

```

EDITOR          VIEW
+  Folder  Save  Find Files
New  Open  Save  Compare
FILE
myProcedure.mu* x
1  myProc := proc(n)
2  begin
3    if n = 1 or n = 0 then
4      1
5    else
6      n*myProc(n - 1)
7    end_if;
8  end_proc:
  
```

Before you can call this procedure at the MATLAB Command Window, you must read the file `myProcedure.mu` into the symbolic engine. To read a program file into the symbolic engine, use `read`:

```
read(symengine, 'myProcedure.mu')
```

If the file is not on the MATLAB path, specify the full path to this file. For example, if `myProcedure.mu` is in the MuPAD folder on disk C, enter:

```
read(symengine, 'C:/MuPAD/myProcedure.mu')
```

Now you can access the procedure `myProc` using `evalin` or `feval`. For example, compute the factorial of 10:

```
feval(symengine, 'myProc', 10)
```

```
ans =  
3628800
```

Input Arguments

filename — name of a MuPAD program file

character vector

Name of a MuPAD program file, specified as a character vector. This file must have the extension `.mu` or `.gz`.

Tips

- If you do not specify the file extension, `read` searches for the file `filename.mu`.
- If `filename` is a GNU® zip file with the extension `.gz`, `read` uncompresses it upon reading.
- `filename` can include full or relative path information. If `filename` does not have a path component, `read` uses the MATLAB function `which` to search for the file on the MATLAB path.
- `read` ignores any MuPAD aliases defined in the program file. If your program file contains aliases or uses the aliases predefined by MATLAB, see “Alternatives” on page 4-1130.

Alternatives

You also can use `feval` to call the MuPAD `read` function. The `read` function available from the MATLAB Command Window is equivalent to calling the MuPAD `read` function with the `Plain` option. It ignores any MuPAD aliases defined in the program file:

```
feval(symengine, 'read', ' "myProcedure.mu" ', 'Plain')
```

If your program file contains aliases or uses the aliases predefined by MATLAB, do not use `Plain`:

```
feval(symengine, 'read', ' "myProcedure.mu" ')
```

Compatibility Considerations

`read(symengine, ...)` is not recommended

Not recommended starting in R2018b

Symbolic Math Toolbox includes operations and functions for symbolic math expressions that parallel MATLAB functionality for numeric values. Unlike MuPAD functionality, Symbolic Math Toolbox functions enable you to work in familiar interfaces, such as the MATLAB Command Window or Live Editor, which offer a smooth workflow and are optimized for usability.

Therefore, instead of passing a MuPAD program file to `read`, enter the equivalent Symbolic Math Toolbox functionality into the MATLAB command line or Live Editor to work with symbolic math expressions. For a list of available functions, see Symbolic Math Toolbox functions list.

To convert a MuPAD notebook file to a MATLAB live script file, see `convertMuPADNotebook`.

If you cannot find the Symbolic Math Toolbox equivalent for MuPAD functionality, contact MathWorks Technical Support.

Although the use of `read` is not recommended, there are no plans to remove it at this time.

Introduced in R2011b

real

Real part of complex number

Syntax

```
real(z)
```

Description

`real(z)` returns the real part of `z`. If `z` is a matrix, `real` acts elementwise on `z`.

Examples

Compute Real Part of Numeric Inputs

Find the real parts of these numbers. Because these numbers are not symbolic objects, you get floating-point results.

```
[real(2 + 3/2*i), real(sin(5*i)), real(2*exp(1 + i))]
```

```
ans =  
    2.0000         0    2.9374
```

Compute Real Part of Symbolic Inputs

Compute the real parts of the numbers converted to symbolic objects:

```
[real(sym(2) + 3/2*i), real(4/(sym(1) + 3*i)), real(sin(sym(5)*i))]
```

```
ans =  
[ 2, 2/5, 0]
```

Compute the real part of this symbolic expression:

```
real(2*exp(1 + sym(i)))
```

```
ans =  
2*cos(1)*exp(1)
```

Compute Real Part of Symbolic Expressions

In general, `real` cannot extract the entire real parts from symbolic expressions containing variables. However, `real` can rewrite and sometimes simplify the input expression:

```
syms a x y  
real(a + 2)  
real(x + y*i)
```

```
ans =  
real(a) + 2
```

```
ans =  
real(x) - imag(y)
```

If you assign numeric values to these variables or specify that these variables are real, `real` can extract the real part of the expression:

```
syms a
a = 5 + 3*i;
real(a + 2)
```

```
ans =
    7
```

```
syms x y real
real(x + y*i)
```

```
ans =
x
```

Clear the assumption that `x` and `y` are real by recreating them using `syms`:

```
syms x y
```

Compute Real Part for Matrix Input

Find the real parts of the elements of matrix `A`:

```
syms x
A = [-1 + sym(i), sinh(x); exp(10 + sym(7)*i), exp(sym(pi)*i)];
real(A)
```

```
ans =
[ -1, real(sinh(x))]
[ cos(7)*exp(10), -1]
```

Input Arguments

z – Input

number | vector | matrix | array | symbolic number | symbolic variable | symbolic array | symbolic function | symbolic expression

Input, specified as a number, vector, matrix, or array, or a symbolic number, variable, array, function, or expression.

Tips

- Calling `real` for a number that is not a symbolic object invokes the MATLAB `real` function.

Alternatives

You can compute the real part of `z` via the conjugate: $\text{real}(z) = (z + \text{conj}(z))/2$.

See Also

`conj` | `imag` | `in` | `sign` | `signIm`

Introduced before R2006a

rectangularPulse

Rectangular pulse function

Syntax

```
rectangularPulse(a,b,x)  
rectangularPulse(x)
```

Description

`rectangularPulse(a,b,x)` returns the “Rectangular Pulse Function” on page 4-1137.

`rectangularPulse(x)` is a shortcut for `rectangularPulse(-1/2,1/2,x)`.

Examples

Plot Rectangular Pulse Function

Plot the rectangular pulse function using `fplot`.

```
syms x  
fplot(rectangularPulse(x), [-1 1])
```

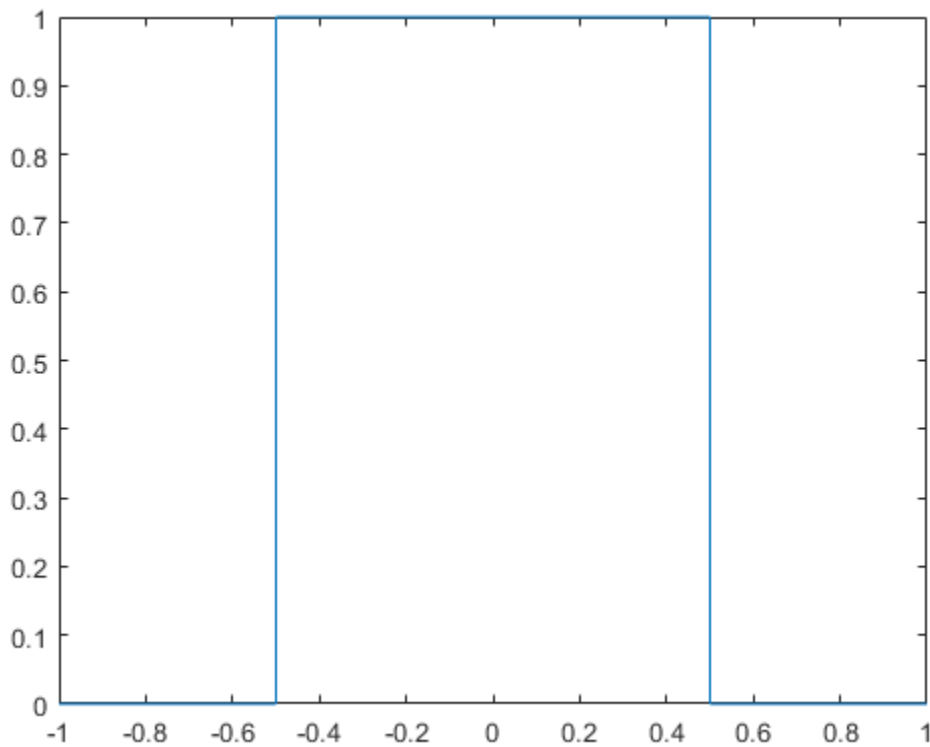

Compute Rectangular Pulse Function

Compute the rectangular pulse function for these numbers. Because these numbers are not symbolic objects, you get floating-point results.

```
[rectangularPulse(-1, 1, -2)
 rectangularPulse(-1, 1, -1)
 rectangularPulse(-1, 1, 0)
 rectangularPulse(-1, 1, 1)
 rectangularPulse(-1, 1, 2)]
```

```
ans =
      0
 0.5000
 1.0000
 0.5000
      0
```

Compute the rectangular pulse function for the same numbers in symbolic form.

```
[rectangularPulse(sym(-1), 1, -2)
 rectangularPulse(-1, sym(1), -1)
 rectangularPulse(-1, 1, sym(0))
 rectangularPulse(sym(-1), 1, 1)
 rectangularPulse(sym(-1), 1, 2)]
```

```
ans =
      0
 1/2
 1
 1/2
      0
```

Edge Values of Rectangular Pulse

Show that if $a < b$, the rectangular pulse function for $x = a$ and $x = b$ equals $1/2$.

```
syms a b x
assume(a < b)
rectangularPulse(a, b, a)
rectangularPulse(a, b, b)
```

```
ans =
1/2
```

```
ans =
1/2
```

For further computations, remove the assumptions on the variables by recreating them using `syms`:

```
syms a b
```

For $a = b$, the rectangular pulse function returns 0 :

```
syms a x
rectangularPulse(a, a, x)
```

```
ans =
0
```

Fixed Rectangular Pulse of Width 1

Compute a rectangular pulse of width by using `rectangularPulse(x)`. This call is equal to `rectangularPulse(-1/2, 1/2, x)`.

```
syms x
rectangularPulse(x)
```

```
ans =
rectangularPulse(-1/2, 1/2, x)
```

```
[rectangularPulse(sym(-1))
 rectangularPulse(sym(-1/2))
 rectangularPulse(sym(0))
 rectangularPulse(sym(1/2))
 rectangularPulse(sym(1))]
```

```
ans =
0
1/2
1
1/2
0
```

Relation Between Heaviside and Rectangular Pulse

When the rising or falling edge of `rectangularPulse` is `Inf`, then the result is in terms of `heaviside`.

```
syms x
rectangularPulse(-inf, 0, x)
rectangularPulse(0, inf, x)
rectangularPulse(-inf, inf, x)
```

```
ans =
heaviside(-x)
```

```
ans =
heaviside(x)
```

```
ans =
1
```

Input Arguments

a — Input

-1/2 (default) | number | symbolic scalar

Input, specified as a number or a symbolic scalar. This argument specifies the rising edge of the rectangular pulse function.

b – Input

-1/2 (default) | number | symbolic scalar

Input, specified as a number or a symbolic scalar. This argument specifies the falling edge of the rectangular pulse function.

x – Input

number | vector | matrix | array | symbolic number | symbolic variable | symbolic array | symbolic function | symbolic expression

Input, specified as a number, vector, matrix, or array, or a symbolic number, variable, array, function, or expression.

More About

Rectangular Pulse Function

- If $a < x < b$, then the rectangular pulse function equals 1.
- If $x = a$ or $x = b$ and $a \neq b$, then the rectangular pulse function equals 1/2.
- Otherwise, it equals 0.

The rectangular pulse function is also called the rectangle function, boxcar function, Pi function, or gate function.

Tips

- If a and b are variables or expressions with variables, `rectangularPulse` assumes that $a < b$. If a and b are numerical values, such that $a > b$, `rectangularPulse` throws an error.
- If $a = b$, `rectangularPulse` returns 0.

See Also

`dirac` | `heaviside` | `triangularPulse`

Introduced in R2012b

reduceDAEIndex

Convert system of first-order differential algebraic equations to equivalent system of differential index 1

Syntax

```
[newEqs,newVars] = reduceDAEIndex(eqs,vars)
[newEqs,newVars,R] = reduceDAEIndex(eqs,vars)
[newEqs,newVars,R,oldIndex] = reduceDAEIndex(eqs,vars)
```

Description

`[newEqs,newVars] = reduceDAEIndex(eqs,vars)` converts a high-index system of first-order differential algebraic equations `eqs` to an equivalent system `newEqs` of differential index 1.

`reduceDAEIndex` keeps the original equations and variables and introduces new variables and equations. After conversion, `reduceDAEIndex` checks the differential index of the new system by calling `isLowIndexDAE`. If the index of `newEqs` is 2 or higher, then `reduceDAEIndex` issues a warning.

`[newEqs,newVars,R] = reduceDAEIndex(eqs,vars)` returns matrix `R` that expresses the new variables in `newVars` as derivatives of the original variables `vars`.

`[newEqs,newVars,R,oldIndex] = reduceDAEIndex(eqs,vars)` returns the differential index, `oldIndex`, of the original system of DAEs, `eqs`.

Examples

Reduce Differential Index of DAE System

Check if the following DAE system has a low (0 or 1) or high (>1) differential index. If the index is higher than 1, then use `reduceDAEIndex` to reduce it.

Create the following system of two differential algebraic equations. Here, the symbolic functions `x(t)`, `y(t)`, and `z(t)` represent the state variables of the system. Specify the equations and variables as two symbolic vectors: equations as a vector of symbolic equations, and variables as a vector of symbolic function calls.

```
syms x(t) y(t) z(t) f(t)
eqs = [diff(x) == x + z, diff(y) == f(t), x == y];
vars = [x(t), y(t), z(t)];
```

Use `isLowIndexDAE` to check the differential index of the system. For this system, `isLowIndexDAE` returns 0 (false). This means that the differential index of the system is 2 or higher.

```
isLowIndexDAE(eqs, vars)
```

```
ans =
    logical
     0
```

Use `reduceDAEIndex` to rewrite the system so that the differential index is 1. The new system has one additional state variable, `Dyt(t)`.

```
[newEqs, newVars] = reduceDAEIndex(eqs, vars)
```

```
newEqs =
    diff(x(t), t) - z(t) - x(t)
                Dyt(t) - f(t)
                x(t) - y(t)
    diff(x(t), t) - Dyt(t)
```

```
newVars =
    x(t)
    y(t)
    z(t)
    Dyt(t)
```

Check if the differential order of the new system is lower than 2.

```
isLowIndexDAE(newEqs, newVars)
```

```
ans =
    logical
     1
```

Reduce the Index and Return More Details

Reduce the differential index of a system that contains two second-order differential algebraic equation. Because the equations are second-order equations, first use `reduceDifferentialOrder` to rewrite the system to a system of first-order DAEs.

Create the following system of two second-order DAEs. Here, $x(t)$, $y(t)$, and $F(t)$ are the state variables of the system. Specify the equations and variables as two symbolic vectors: equations as a vector of symbolic equations, and variables as a vector of symbolic function calls.

```
syms t x(t) y(t) F(t) r g
eqs = [diff(x(t), t, t) == -F(t)*x(t),...
       diff(y(t), t, t) == -F(t)*y(t) - g,...
       x(t)^2 + y(t)^2 == r^2 ];
vars = [x(t), y(t), F(t)];
```

Rewrite this system so that all equations become first-order differential equations. The `reduceDifferentialOrder` function replaces the second-order DAE by two first-order expressions by introducing the new variables $Dxt(t)$ and $Dyt(t)$. It also replaces the first-order equations by symbolic expressions.

```
[eqs, vars] = reduceDifferentialOrder(eqs, vars)
```

```
eqs =
    diff(Dxt(t), t) + F(t)*x(t)
    diff(Dyt(t), t) + g + F(t)*y(t)
    - r^2 + x(t)^2 + y(t)^2
    Dxt(t) - diff(x(t), t)
    Dyt(t) - diff(y(t), t)
```

```
vars =
    x(t)
    y(t)
```

```

F(t)
Dxt(t)
Dyt(t)

```

Use `reduceDAEIndex` to rewrite the system so that the differential index is 1.

```
[eqs, vars, R, originalIndex] = reduceDAEIndex(eqs, vars)
```

```

eqs =
    Dxtt(t) + F(t)*x(t)
    g + Dytt(t) + F(t)*y(t)
    - r^2 + x(t)^2 + y(t)^2
    Dx(t) - Dxt1(t)
    Dyt(t) - Dyt1(t)
    2*Dxt1(t)*x(t) + 2*Dyt1(t)*y(t)
2*Dxt1(t)*x(t) + 2*Dxt1(t)^2 + 2*Dyt1(t)^2 + 2*y(t)*diff(Dyt1(t), t)
    Dxtt(t) - Dxt1t(t)
    Dytt(t) - diff(Dyt1(t), t)
    Dyt1(t) - diff(y(t), t)

```

```

vars =
    x(t)
    y(t)
    F(t)
    Dx(t)
    Dyt(t)
    Dytt(t)
    Dxtt(t)
    Dxt1(t)
    Dyt1(t)
    Dxt1t(t)

```

```

R =
[ Dytt(t), diff(Dyt(t), t)]
[ Dxtt(t), diff(Dxt(t), t)]
[ Dxt1(t), diff(x(t), t)]
[ Dyt1(t), diff(y(t), t)]
[ Dxt1t(t), diff(x(t), t, t)]

```

```

originalIndex =
    3

```

Use `reduceRedundancies` to shorten the system.

```
[eqs, vars] = reduceRedundancies(eqs, vars)
```

```

eqs =
    Dxtt(t) + F(t)*x(t)
    g + Dytt(t) + F(t)*y(t)
    - r^2 + x(t)^2 + y(t)^2
    2*Dxt(t)*x(t) + 2*Dyt(t)*y(t)
2*Dxtt(t)*x(t) + 2*Dytt(t)*y(t) + 2*Dxt(t)^2 + 2*Dyt(t)^2
    Dytt(t) - diff(Dyt(t), t)
    Dyt(t) - diff(y(t), t)

```

```

vars =
    x(t)
    y(t)
    F(t)

```

$Dx(t)$
 $Dy(t)$
 $Dy''(t)$
 $Dx''(t)$

Input Arguments

eqs — System of first-order DAEs

vector of symbolic equations | vector of symbolic expressions

System of first-order DAEs, specified as a vector of symbolic equations or expressions.

vars — State variables

vector of symbolic functions | vector of symbolic function calls

State variables, specified as a vector of symbolic functions or function calls, such as $x(t)$.

Example: $[x(t), y(t)]$

Output Arguments

newEqs — System of first-order DAEs of differential index 1

column vector of symbolic expressions

System of first-order DAEs of differential index 1, returned as a column vector of symbolic expressions.

newVars — Extended set of variables

column vector of symbolic function calls

Extended set of variables, returned as a column vector of symbolic function calls. This vector includes the original state variables `vars` followed by the generated variables that replace the second- and higher-order derivatives in `eqs`.

R — Relations between new and original variables

symbolic matrix

Relations between new and original variables, returned as a symbolic matrix with two columns. The first column contains the new variables. The second column contains their definitions as derivatives of the original variables `vars`.

oldIndex — Differential index of original DAE system

integer

Differential index of original DAE system, returned as an integer or NaN.

Algorithms

The implementation of `reduceDAEIndex` uses the Pantelides algorithm. This algorithm reduces higher-index systems to lower-index systems by selectively adding differentiated forms of the original equations. The Pantelides algorithm can underestimate the differential index of a new system, and therefore, can fail to reduce the differential index to 1. In this case, `reduceDAEIndex` issues a warning and, for the syntax with four output arguments, returns the value of `oldIndex` as NaN. The

reduceDAEToODE function uses more reliable, but slower Gaussian elimination. Note that reduceDAEToODE requires the DAE system to be semilinear.

See Also

daeFunction | decic | findDecoupledBlocks | incidenceMatrix | isLowIndexDAE | massMatrixForm | odeFunction | reduceDAEToODE | reduceDifferentialOrder | reduceRedundancies

Topics

“Solve Differential Algebraic Equations (DAEs)” on page 2-194

Introduced in R2014b

reduceDAEToODE

Convert system of first-order semilinear differential algebraic equations to equivalent system of differential index 0

Syntax

```
newEqs = reduceDAEToODE(eqs, vars)
[newEqs, constraintEqs] = reduceDAEToODE(eqs, vars)
[newEqs, constraintEqs, oldIndex] = reduceDAEToODE(eqs, vars)
```

Description

`newEqs = reduceDAEToODE(eqs, vars)` converts a high-index system of first-order semilinear algebraic equations `eqs` to an equivalent system of ordinary differential equations, `newEqs`. The differential index of the new system is 0, that is, the Jacobian of `newEqs` with respect to the derivatives of the variables in `vars` is invertible.

`[newEqs, constraintEqs] = reduceDAEToODE(eqs, vars)` returns a vector of constraint equations.

`[newEqs, constraintEqs, oldIndex] = reduceDAEToODE(eqs, vars)` returns the differential index `oldIndex` of the original system of semilinear DAEs, `eqs`.

Examples

Convert DAE System to Implicit ODE System

Convert a system of differential algebraic equations (DAEs) to a system of implicit ordinary differential equations (ODEs).

Create the following system of two differential algebraic equations. Here, the symbolic functions $x(t)$, $y(t)$, and $z(t)$ represent the state variables of the system. Specify the equations and variables as two symbolic vectors: equations as a vector of symbolic equations, and variables as a vector of symbolic function calls.

```
syms x(t) y(t) z(t)
eqs = [diff(x,t)+x*diff(y,t) == y,...
       x*diff(x, t)+x^2*diff(y) == sin(x),...
       x^2 + y^2 == t*z];
vars = [x(t), y(t), z(t)];
```

Use `reduceDAEToODE` to rewrite the system so that the differential index is 0.

```
newEqs = reduceDAEToODE(eqs, vars)
```

```
newEqs =
           x(t)*diff(y(t), t) - y(t) + diff(x(t), t)
diff(x(t), t)*(cos(x(t)) - y(t)) - x(t)*diff(y(t), t)
z(t) - 2*x(t)*diff(x(t), t) - 2*y(t)*diff(y(t), t) + t*diff(z(t), t)
```

Reduce System and Return More Details

Check if the following DAE system has a low (0 or 1) or high (>1) differential index. If the index is higher than 1, first try to reduce the index by using `reduceDAEIndex` and then by using `reduceDAEToODE`.

Create the system of differential algebraic equations. Here, the functions $x_1(t)$, $x_2(t)$, and $x_3(t)$ represent the state variables of the system. The system also contains the functions $q_1(t)$, $q_2(t)$, and $q_3(t)$. These functions do not represent state variables. Specify the equations and variables as two symbolic vectors: equations as a vector of symbolic equations, and variables as a vector of symbolic function calls.

```
syms x1(t) x2(t) x3(t) q1(t) q2(t) q3(t)
eqs = [diff(x2) == q1 - x1,
       diff(x3) == q2 - 2*x2 - t*(q1-x1),
       q3 - t*x2 - x3];
vars = [x1(t), x2(t), x3(t)];
```

Use `isLowIndexDAE` to check the differential index of the system. For this system, `isLowIndexDAE` returns 0 (false). This means that the differential index of the system is 2 or higher.

```
isLowIndexDAE(eqs, vars)
```

```
ans =
    logical
     0
```

Use `reduceDAEIndex` as your first attempt to rewrite the system so that the differential index is 1. For this system, `reduceDAEIndex` issues a warning because it cannot reduce the differential index of the system to 0 or 1.

```
[newEqs, newVars] = reduceDAEIndex(eqs, vars)
```

Warning: Index of reduced DAEs is larger than 1.

```
newEqs =
          x1(t) - q1(t) + diff(x2(t), t)
Dx3t(t) - q2(t) + 2*x2(t) + t*(q1(t) - x1(t))
          q3(t) - x3(t) - t*x2(t)
diff(q3(t), t) - x2(t) - t*diff(x2(t), t) - Dx3t(t)
```

```
newVars =
    x1(t)
    x2(t)
    x3(t)
Dx3t(t)
```

If `reduceDAEIndex` cannot reduce the semilinear system so that the index is 0 or 1, try using `reduceDAEToODE`. This function can be much slower, therefore it is not recommended as a first choice. Use the syntax with two output arguments to also return the constraint equations.

```
[newEqs, constraintEqs] = reduceDAEToODE(eqs, vars)
```

```
newEqs =
          x1(t) - q1(t) + diff(x2(t), t)
          2*x2(t) - q2(t) + t*q1(t) - t*x1(t) + diff(x3(t), t)
diff(x1(t), t) - diff(q1(t), t) + diff(q2(t), t, t) - diff(q3(t), t, t)
```

```

constraintEqs =
  x1(t) - q1(t) + diff(q2(t), t) - diff(q3(t), t, t)
                    x3(t) - q3(t) + t*x2(t)
                    x2(t) - q2(t) + diff(q3(t), t)

```

Use the syntax with three output arguments to return the new equations, constraint equations, and the differential index of the original system, `eqs`.

```
[newEqs, constraintEqs, oldIndex] = reduceDAEToODE(eqs, vars)
```

```

newEqs =
                    x1(t) - q1(t) + diff(x2(t), t)
                    2*x2(t) - q2(t) + t*q1(t) - t*x1(t) + diff(x3(t), t)
diff(x1(t), t) - diff(q1(t), t) + diff(q2(t), t, t) - diff(q3(t), t, t, t)

constraintEqs =
  x1(t) - q1(t) + diff(q2(t), t) - diff(q3(t), t, t)
                    x3(t) - q3(t) + t*x2(t)
                    x2(t) - q2(t) + diff(q3(t), t)

oldIndex =
    3

```

Input Arguments

eqs — System of first-order semilinear DAEs

vector of symbolic equations | vector of symbolic expressions

System of first-order semilinear DAEs, specified as a vector of symbolic equations or expressions.

vars — State variables

vector of symbolic functions | vector of symbolic function calls

State variables, specified as a vector of symbolic functions or function calls, such as $x(t)$.

Example: $[x(t), y(t)]$ or $[x(t); y(t)]$

Output Arguments

newEqs — System of implicit ordinary differential equations

column vector of symbolic expressions

System of implicit ordinary differential equations, returned as a column vector of symbolic expressions. The differential index of this system is 0.

constraintEqs — Constraint equations encountered during system reduction

column vector of symbolic expressions

Constraint equations encountered during system reduction, returned as a column vector of symbolic expressions. These expressions depend on the variables `vars`, but not on their derivatives. The constraints are conserved quantities of the differential equations in `newEqs`, meaning that the time derivative of each constraint vanishes modulo the equations in `newEqs`.

You can use these equations to determine consistent initial conditions for the DAE system.

oldIndex — Differential index of original DAE system eqs

integer

Differential index of original DAE system eqs, returned as an integer.

Algorithms

The implementation of `reduceDAEToODE` is based on Gaussian elimination. This algorithm is more reliable than the Pantelides algorithm used by `reduceDAEIndex`, but it can be much slower.

See Also

`daeFunction` | `decic` | `findDecoupledBlocks` | `incidenceMatrix` | `isLowIndexDAE` | `massMatrixForm` | `odeFunction` | `reduceDAEIndex` | `reduceDifferentialOrder` | `reduceRedundancies`

Topics

“Solve Semilinear DAE System” on page 2-203

Introduced in R2014b

reduceDifferentialOrder

Reduce system of higher-order differential equations to equivalent system of first-order differential equations

Syntax

```
[newEqs,newVars] = reduceDifferentialOrder(eqs,vars)
[newEqs,newVars,R] = reduceDifferentialOrder(eqs,vars)
```

Description

`[newEqs,newVars] = reduceDifferentialOrder(eqs,vars)` rewrites a system of higher-order differential equations `eqs` as a system of first-order differential equations `newEqs` by substituting derivatives in `eqs` with new variables. Here, `newVars` consists of the original variables `vars` augmented with these new variables.

`[newEqs,newVars,R] = reduceDifferentialOrder(eqs,vars)` returns the matrix `R` that expresses the new variables in `newVars` as derivatives of the original variables `vars`.

Examples

Reduce Differential Order of DAE System

Reduce a system containing higher-order DAEs to a system containing only first-order DAEs.

Create the system of differential equations, which includes a second-order expression. Here, $x(t)$ and $y(t)$ are the state variables of the system, and $c1$ and $c2$ are parameters. Specify the equations and variables as two symbolic vectors: equations as a vector of symbolic equations, and variables as a vector of symbolic function calls.

```
syms x(t) y(t) c1 c2
eqs = [diff(x(t), t, t) + sin(x(t)) + y(t) == c1*cos(t),...
       diff(y(t), t) == c2*x(t)];
vars = [x(t), y(t)];
```

Rewrite this system so that all equations become first-order differential equations. The `reduceDifferentialOrder` function replaces the higher-order DAE by first-order expressions by introducing the new variable $Dxt(t)$. It also represents all equations as symbolic expressions.

```
[newEqs, newVars] = reduceDifferentialOrder(eqs, vars)
```

```
newEqs =
    diff(Dxt(t), t) + sin(x(t)) + y(t) - c1*cos(t)
    diff(y(t), t) - c2*x(t)
    Dxt(t) - diff(x(t), t)
```

```
newVars =
    x(t)
    y(t)
    Dxt(t)
```

Show Relations Between Generated and Original Variables

Reduce a system containing a second- and a third-order expression to a system containing only first-order DAEs. In addition, return a matrix that expresses the variables generated by `reduceDifferentialOrder` via the original variables of this system.

Create a system of differential equations, which includes a second- and a third-order expression. Here, $x(t)$ and $y(t)$ are the state variables of the system. Specify the equations and variables as two symbolic vectors: equations as a vector of symbolic equations, and variables as a vector of symbolic function calls.

```
syms x(t) y(t) f(t)
eqs = [diff(x(t),t,t) == diff(f(t),t,t,t), diff(y(t),t,t,t) == diff(f(t),t,t)];
vars = [x(t), y(t)];
```

Call `reduceDifferentialOrder` with three output arguments. This syntax returns matrix R with two columns: the first column contains the new variables, and the second column expresses the new variables as derivatives of the original variables, $x(t)$ and $y(t)$.

```
[newEqs, newVars, R] = reduceDifferentialOrder(eqs, vars)
```

```
newEqs =
    diff(Dxt(t), t) - diff(f(t), t, t, t)
    diff(Dytt(t), t) - diff(f(t), t, t)
           Dxt(t) - diff(x(t), t)
           Dyt(t) - diff(y(t), t)
           Dytt(t) - diff(Dyt(t), t)
```

```
newVars =
    x(t)
    y(t)
    Dxt(t)
    Dyt(t)
    Dytt(t)
```

```
R =
 [ Dxt(t), diff(x(t), t)]
 [ Dyt(t), diff(y(t), t)]
 [ Dytt(t), diff(y(t), t, t)]
```

Input Arguments

eqs — System containing higher-order differential equations

vector of symbolic equations | vector of symbolic expressions

System containing higher-order differential equations, specified as a vector of symbolic equations or expressions.

vars — Variables of original differential equations

vector of symbolic functions | vector of symbolic function calls

Variables of original differential equations, specified as a vector of symbolic functions, or function calls, such as $x(t)$.

Example: `[x(t), y(t)]`

Output Arguments

newEqs — System of first-order differential equations

column vector of symbolic expressions

System of first-order differential equations, returned as a column vector of symbolic expressions.

newVars — Extended set of variables

column vector of symbolic function calls

Extended set of variables, returned as a column vector of symbolic function calls. This vector includes the original state variables `vars` followed by the generated variables that replace the higher-order derivatives in `eqs`.

R — Relations between new and original variables

symbolic matrix

Relations between new and original variables, returned as a symbolic matrix with two columns. The first column contains the new variables `newVars`. The second column contains their definition as derivatives of the original variables `vars`.

See Also

`daeFunction` | `decic` | `findDecoupledBlocks` | `incidenceMatrix` | `isLowIndexDAE` | `massMatrixForm` | `odeFunction` | `reduceDAEIndex` | `reduceDAEToODE` | `reduceRedundancies`

Topics

“Solve Differential Algebraic Equations (DAEs)” on page 2-194

Introduced in R2014b

reduceRedundancies

Simplify system of first-order differential algebraic equations by eliminating redundant equations and variables

Syntax

```
[newEqs,newVars] = reduceRedundancies(eqs,vars)
[newEqs,newVars,R] = reduceRedundancies(eqs,vars)
```

Description

[newEqs,newVars] = reduceRedundancies(eqs,vars) eliminates redundant equations and variables from the system of first-order differential algebraic equations (DAEs) eqs. The input argument vars specifies the state variables of the system.

reduceRedundancies returns the new DAE system as a column vector newEqs and the reduced state variables as a column vector newVars. Each element of newEqs represents an equation with right side equal to zero.

[newEqs,newVars,R] = reduceRedundancies(eqs,vars) returns a structure array R containing information on the eliminated equations and variables.

Examples

Reduce DAE System by Removing Redundant Equations

Simplify a system of five differential algebraic equations (DAEs) in four state variables to a system of two equations in two state variables.

Create the following system of five DAEs in four state variables $x_1(t)$, $x_2(t)$, $x_3(t)$, and $x_4(t)$. The system also contains symbolic parameters a_1 , a_2 , a_3 , a_4 , b , c , and the function $f(t)$ that are not state variables.

```
syms x1(t) x2(t) x3(t) x4(t) a1 a2 a3 a4 b c f(t)
eqs = [a1*diff(x1(t),t)+a2*diff(x2(t),t) == b*x4(t),
       a3*diff(x2(t),t)+a4*diff(x3(t),t) == c*x4(t),
       x1(t) == 2*x2(t),
       x4(t) == f(t),
       f(t) == sin(t)];
vars = [x1(t),x2(t),x3(t),x4(t)];
```

Use reduceRedundancies to eliminate redundant equations and corresponding state variables.

```
[newEqs,newVars] = reduceRedundancies(eqs,vars)
```

```
newEqs =
```

$$\begin{pmatrix} a_1 \frac{\partial}{\partial t} x_1(t) + \frac{a_2}{2} \frac{\partial}{\partial t} x_1(t) - b f(t) \\ \frac{a_3}{2} \frac{\partial}{\partial t} x_1(t) + a_4 \frac{\partial}{\partial t} x_3(t) - c f(t) \end{pmatrix}$$

```
newVars =
  (x1(t))
  (x3(t))
```

Specify Input Order of State Variables

Specify input order of the state variables to choose which variables are being returned when eliminating DAEs.

Create a system of four DAEs in four state variables $V_{ac}(t)$, $V_1(t)$, $V_2(t)$, and $I(t)$. The system also contains symbolic parameters L , R , and V_0 .

```
syms V_ac(t) V1(t) V2(t) I(t) L R V0
eqs = [V_ac(t) == V1(t) + V2(t),
       V1(t) == I(t)*R,
       V2(t) == L*diff(I(t),t),
       V_ac(t) == V0*cos(t)]
```

```
eqs =
  (V_ac(t) = V1(t) + V2(t))
  (V1(t) = R I(t))
  (V2(t) = L * d/dt I(t))
  (V_ac(t) = V0 cos(t))
```

```
vars = [V_ac(t), I(t), V1(t), V2(t)]
```

```
vars = (V_ac(t) I(t) V1(t) V2(t))
```

Use `reduceRedundancies` to eliminate redundant equations and variables. `reduceRedundancies` prioritizes to keep the state variables in the vector `vars` starting from the first element.

```
[newEqs, newVars] = reduceRedundancies(eqs, vars)
```

```
newEqs =
  -L * d/dt I(t) - R I(t) + V0 cos(t)
```

```
newVars = I(t)
```

Here, `reduceRedundancies` returns a reduced equation in term of the variable $I(t)$.

When multiple ways of reducing the DAEs exist, specify a different input order of the state variables to choose which variables are being returned. Specify another vector that contains a different order of the state variables. Eliminate the DAEs again.

```
vars2 = [V_ac(t), V1(t), V2(t), I(t)]
```

```
vars2 = (V_ac(t) V1(t) V2(t) I(t))
```

```
[newEqs, newVars] = reduceRedundancies(eqs, vars2)
```

```
newEqs =
```

$$\frac{L \frac{\partial}{\partial t} V_1(t) + R V_1(t) - R V_0 \cos(t)}{R}$$

`newVars = V1(t)`

Here, `reduceRedundancies` returns a reduced equation in term of the state variable `V1(t)`.

Obtain Information About Eliminated Equations

Declare three output arguments when calling `reduceRedundancies` to simplify a system of equations and return information about the eliminated equations.

Create the following system of five differential algebraic equations (DAEs) in four state variables `x1(t)`, `x2(t)`, `x3(t)`, and `x4(t)`. The system also contains symbolic parameters `a1`, `a2`, `a3`, `a4`, `b`, `c`, and the function `f(t)` that are not state variables.

```
syms x1(t) x2(t) x3(t) x4(t) a1 a2 a3 a4 b c f(t)
eqs = [a1*diff(x1(t),t)+a2*diff(x2(t),t) == b*x4(t),
       a3*diff(x2(t),t)+a4*diff(x3(t),t) == c*x4(t),
       x1(t) == 2*x2(t),
       x4(t) == f(t),
       f(t) == sin(t)];
vars = [x1(t),x2(t),x3(t),x4(t)];
```

Call `reduceRedundancies` with three output arguments.

```
[newEqs,newVars,R] = reduceRedundancies(eqs,vars)
```

```
newEqs =

$$\begin{pmatrix} a_1 \frac{\partial}{\partial t} x_1(t) + \frac{a_2}{2} \frac{\partial}{\partial t} x_1(t) - b f(t) \\ \frac{a_3}{2} \frac{\partial}{\partial t} x_1(t) + a_4 \frac{\partial}{\partial t} x_3(t) - c f(t) \end{pmatrix}$$

```

```
newVars =

$$\begin{pmatrix} x_1(t) \\ x_3(t) \end{pmatrix}$$

```

```
R = struct with fields:
    solvedEquations: [2x1 sym]
    constantVariables: [1x2 sym]
    replacedVariables: [1x2 sym]
    otherEquations: [1x1 sym]
```

The function `reduceRedundancies` returns information about eliminated equations to `R`. Here, `R` is a structure array with four fields.

The `solvedEquations` field contains the equations that are eliminated by `reduceRedundancies`. The eliminated equations contain those state variables from `vars` that do not appear in `newEqs`. The right side of each eliminated equation is equal to zero.

```
R1 = R.solvedEquations
```

$$R1 = \begin{pmatrix} x_1(t) - 2x_2(t) \\ x_4(t) - f(t) \end{pmatrix}$$

The `constantVariables` field contains a matrix with two columns. The first column contains those state variables from `vars` that `reduceRedundancies` replaced by constant values. The second column contains the corresponding constant values.

$$R2 = R.constantVariables$$

$$R2 = \begin{pmatrix} x_4(t) & f(t) \end{pmatrix}$$

The `replacedVariables` field contains a matrix with two columns. The first column contains those state variables from `vars` that `reduceRedundancies` replaced by expressions in terms of other variables. The second column contains the corresponding values of the eliminated variables.

$$R3 = R.replacedVariables$$

$$R3 = \begin{pmatrix} x_2(t) & \frac{x_1(t)}{2} \end{pmatrix}$$

The `otherEquations` field contains those equations from `eqs` that do not contain any of the state variables `vars`.

$$R4 = R.otherEquations$$

$$R4 = f(t) - \sin(t)$$

Input Arguments

eqs — System of first-order DAEs

vector of symbolic equations | vector of symbolic expressions

System of first-order DAEs, specified as a vector of symbolic equations or expressions.

The relation operator `==` defines symbolic equations. If you specify the element of `eqs` as a symbolic expression without a right side, then a symbolic equation with right side equal to zero is assumed.

vars — State variables

vector of symbolic functions | vector of symbolic function calls

State variables, specified as a vector of symbolic functions or function calls, such as `x(t)`.

The input order of the state variables determines which reduced variables are being returned. If multiple ways of reducing the DAEs exist, then `reduceRedundancies` prioritizes to keep the state variables in `vars` starting from the first element.

Example: `[x(t), z(t), y(t)]`

Output Arguments

newEqs — System of first-order DAEs

column vector of symbolic expressions

System of first-order DAEs, returned as a column vector of symbolic expressions. Each element of `newEqs` represents an equation with right side equal to zero.

newVars — Reduced set of variables

column vector of symbolic function calls

Reduced set of variables, returned as a column vector of symbolic function calls.

R — Information about eliminated variables

structure array

Information about eliminated variables, returned as a structure array containing four fields. To access this information, use:

- `R.solvedEquations` to return a symbolic column vector of all equations that `reduceRedundancies` used to replace those state variables that do not appear in `newEqs`.
- `R.constantVariables` to return a matrix with the following two columns. The first column contains those original state variables of the vector `vars` that were eliminated and replaced by constant values. The second column contains the corresponding constant values.
- `R.replacedVariables` to return a matrix with the following two columns. The first column contains those original state variables of the vector `vars` that were eliminated and replaced in terms of other variables. The second column contains the corresponding values of the eliminated variables.
- `R.otherEquations` to return a column vector containing all original equations `eqs` that do not contain any of the input variables `vars`.

See Also

`daeFunction` | `decic` | `findDecoupledBlocks` | `incidenceMatrix` | `isLowIndexDAE` | `massMatrixForm` | `odeFunction` | `reduceDAEIndex` | `reduceDAEtoODE` | `reduceDifferentialOrder`

Topics

“Solve Differential Algebraic Equations (DAEs)” on page 2-194

Introduced in R2014b

release

Evaluate integrals

Syntax

```
release(expr)
```

Description

`release(expr)` evaluates the integrals in the expression `expr`. The `release` function ignores the 'Hold' option in the `int` function when the integrals are defined.

Examples

Unevaluated Integral

Define a symbolic call to an integral $\int \cos(x) dx$ without evaluating it. Set the 'Hold' option to true when defining the integral using the `int` function.

```
syms x
F = int(cos(x), 'Hold', true)
```

```
F =
  ∫ cos(x) dx
```

Use `release` to evaluate the integral by ignoring the 'Hold' option.

```
G = release(F)
```

```
G = sin(x)
```

Unevaluated Integral and Integration by Parts

Find the integral of $\int x e^x dx$.

Define the integral without evaluating it by setting the 'Hold' option to true.

```
syms x g(y)
F = int(x*exp(x), 'Hold', true)
```

```
F =
  ∫ x ex dx
```

You can apply integration by parts to `F` by using the `integrateByParts` function. Use `exp(x)` as the differential to be integrated.

```
G = integrateByParts(F, exp(x))
```

$$G = x e^x - \int e^x dx$$

To evaluate the integral in G, use the `release` function to ignore the 'Hold' option.

```
Gcalc = release(G)
```

$$Gcalc = x e^x - e^x$$

Compare the result to the integration result returned by `int` without setting the 'Hold' option.

```
Fcalc = int(x*exp(x))
```

$$Fcalc = e^x (x - 1)$$

Integration by Substitution

Find the integral of $\int \cos(\log(x)) dx$ using integration by substitution.

Define the integral without evaluating it by setting the 'Hold' option to `true`.

```
syms x t
F = int(cos(log(x)), 'Hold', true)
```

$$F = \int \cos(\log(x)) dx$$

Substitute the expression $\log(x)$ with `t`.

```
G = changeIntegrationVariable(F, log(x), t)
```

$$G = \int e^t \cos(t) dt$$

To evaluate the integral in G, use the `release` function to ignore the 'Hold' option.

```
H = release(G)
```

$$H = \frac{e^t (\cos(t) + \sin(t))}{2}$$

Restore $\log(x)$ in place of `t`.

```
H = simplify(subs(H, t, log(x)))
```

$$H = \frac{\sqrt{2} x \sin\left(\frac{\pi}{4} + \log(x)\right)}{2}$$

Compare the result to the integration result returned by `int` without setting the 'Hold' option to `true`.

```
Fcalc = int(cos(log(x)))
```

```
Fcalc =
```

$$\frac{\sqrt{2} \times \sin\left(\frac{\pi}{4} + \log(x)\right)}{2}$$

Input Arguments

expr — Expression containing integrals

symbolic expression | symbolic function | symbolic vector | symbolic matrix

Expression containing integrals, specified as a symbolic expression, function, vector, or matrix.

See Also

changeIntegrationVariable | diff | int | integrateByParts

Introduced in R2019b

rem

Remainder after division

Syntax

```
rem(a,b)
```

Description

`rem(a,b)` finds the remainder after division. If $b \neq 0$, then $\text{rem}(a,b) = a - \text{fix}(a/b)*b$. If $b = 0$ or $b = \text{Inf}$ or $b = -\text{Inf}$, then `rem` returns NaN.

The `rem` function does not support complex numbers: all values must be real numbers.

To find the remainder after division of polynomials, use `quorem`.

Examples

Divide Integers by Integers

Find the remainder after division in case both the dividend and divisor are integers.

Find the modulus after division for these numbers.

```
[rem(sym(27), 4), rem(sym(27), -4), rem(sym(-27), 4), rem(sym(-27), -4)]
```

```
ans =  
[ 3, 3, -3, -3]
```

Divide Rationals by Integers

Find the remainder after division in case the dividend is a rational number, and the divisor is an integer.

Find the remainder after division for these numbers.

```
[rem(sym(22/3), 5), rem(sym(1/2), -7), rem(sym(27/6), -11)]
```

```
ans =  
[ 7/3, 1/2, 9/2]
```

Divide Elements of Matrices

For vectors and matrices, `rem` finds the remainder after division element-wise. Nonscalar arguments must be the same size.

Find the remainder after division for the elements of these two matrices.

```
A = sym([27, 28; 29, 30]);  
B = sym([2, 3; 4, 5]);  
rem(A,B)
```

```
ans =  
[ 1, 1]  
[ 1, 0]
```

Find the remainder after division for the elements of matrix A and the value 9. Here, `rem` expands 9 into the 2-by-2 matrix with all elements equal to 9.

```
rem(A,9)
```

```
ans =  
[ 0, 1]  
[ 2, 3]
```

Input Arguments

a — Dividend (numerator)

number | symbolic number | vector | matrix

Dividend (numerator), specified as a number, symbolic number, or a vector or matrix of numbers or symbolic numbers.

b — Divisor (denominator)

number | symbolic number | vector | matrix

Divisor (denominator), specified as a number, symbolic number, or a vector or matrix of numbers or symbolic numbers.

Tips

- Calling `rem` for numbers that are not symbolic objects invokes the MATLAB `rem` function.
- All nonscalar arguments must be the same size. If one input arguments is nonscalar, then `mod` expands the scalar into a vector or matrix of the same size as the nonscalar argument, with all elements equal to the corresponding scalar.

See Also

`mod` | `quorem`

Introduced before R2006a

removeUnit

Remove unit

Syntax

```
removeUnit(unit)
```

Description

`removeUnit(unit)` removes the symbolic unit `unit`. You can remove only user-defined units created with `newUnit`. You cannot remove predefined units. If `unit` is a vector, `removeUnit` removes all units in `unit`.

Examples

Remove Unit

Remove units you define by using `removeUnit`. Create the unit `warp3`, use the unit in calculations, and then remove the unit.

Define the unit `warp3` as 3 times the speed of light.

```
u = symunit;  
warp3 = newUnit('warp3',3*u.c_0)
```

```
warp3 =  
[warp3]
```

Convert `1e10` meter per second to `u.warp3`.

```
speed = rewrite(1e10*u.m/u.s,u.warp3)
```

```
speed =  
(5000000000/449688687)*[warp3]
```

After calculations, remove the unit `u.warp3` by using `removeUnit`.

```
removeUnit(u.warp3)
```

Conversion to `u.warp3` now throws an error.

Input Arguments

unit – Unit name

symbolic unit | vector of symbolic units

Unit name, specified as a symbolic unit or a vector of symbolic units.

See Also

`checkUnits` | `isUnit` | `newUnit` | `newUnitSystem` | `symunit`

Topics

“Units of Measurement Tutorial” on page 2-19

“Unit Conversions and Unit Systems” on page 2-39

“Units and Unit Systems List” on page 2-25

External Websites

The International System of Units (SI)

Introduced in R2017b

reset

(Not recommended) Close MuPAD engine

Note `reset(symengine)` is not recommended. Call `clear all` instead. For more information, see “Compatibility Considerations”.

Syntax

```
reset(symengine)
```

Description

`reset(symengine)` closes the MuPAD engine associated with the MATLAB workspace, and resets all its assumptions. Immediately before or after executing `reset(symengine)` you should clear all symbolic objects in the MATLAB workspace.

Compatibility Considerations

reset(symengine) is not recommended

Not recommended starting in R2018b

To update your code, replace any instance of `reset(symengine)` with `clear all`. The `clear all` call closes the MuPAD engine associated with the MATLAB Workspace, resets all associated assumptions, and removes all variables, including symbolic objects, from the MATLAB Workspace.

Although the use of `reset` is not recommended, there are no plans to remove it at this time.

Introduced in R2008b

reshape

Reshape symbolic array

Syntax

```
reshape(A, n1, n2)
reshape(A, n1, ..., nM)
reshape(A, ..., [], ...)
reshape(A, sz)
```

Description

`reshape(A, n1, n2)` returns the $n1$ -by- $n2$ matrix, which has the same elements as A . The elements are taken column-wise from A to fill in the elements of the $n1$ -by- $n2$ matrix.

`reshape(A, n1, ..., nM)` returns the $n1$ -by-...-by- nM array, which has the same elements as A . The elements are taken column-wise from A to fill in the elements of the $n1$ -by-...-by- nM array.

`reshape(A, ..., [], ...)` lets you represent a size value with the placeholder `[]` while calculating the magnitude of that size value automatically. For example, if A has size 2-by-6, then `reshape(A, 4, [])` returns a 4-by-3 array.

`reshape(A, sz)` reshapes A into an array with size specified by sz , where sz is a vector.

Examples

Reshape Symbolic Row Vector into Column Vector

Reshape V , which is a 1-by-4 row vector, into the 4-by-1 column vector Y . Here, V and Y must have the same number of elements.

Create the vector V .

```
syms f(x) y
V = [3 f(x) -4 y]
```

```
V =
[ 3, f(x), -4, y]
```

Reshape V into Y .

```
Y = reshape(V, 4, 1)
```

```
Y =
 3
f(x)
-4
 y
```

Alternatively, use $Y = V.''$ where `.'` is the nonconjugate transpose.

Reshape Symbolic Matrix

Reshape the 2-by-6 symbolic matrix M into a 4-by-3 matrix.

```
M = sym([1 9 4 3 0 1; 3 9 5 1 9 2])
```

```
N = reshape(M,4,3)
```

```
M =
```

```
[ 1, 9, 4, 3, 0, 1]
 [ 3, 9, 5, 1, 9, 2]
```

```
N =
```

```
[ 1, 4, 0]
 [ 3, 5, 9]
 [ 9, 3, 1]
 [ 9, 1, 2]
```

M and N must have the same number of elements. `reshape` reads M column-wise to fill in the elements of N column-wise.

Alternatively, use a size vector to specify the dimensions of the reshaped matrix.

```
sz = [4 3];
```

```
N = reshape(M,sz)
```

```
N =
```

```
[ 1, 4, 0]
 [ 3, 5, 9]
 [ 9, 3, 1]
 [ 9, 1, 2]
```

Automatically Set Dimension of Reshaped Matrix

When you replace a dimension with the placeholder `[]`, `reshape` calculates the required magnitude of that dimension to reshape the matrix.

Create the matrix M.

```
M = sym([1 9 4 3 0 1; 3 9 5 1 9 2])
```

```
M =
```

```
[ 1, 9, 4, 3, 0, 1]
 [ 3, 9, 5, 1, 9, 2]
```

Reshape M into a matrix with three columns.

```
reshape(M,[],3)
```

```
ans =
```

```
[ 1, 4, 0]
 [ 3, 5, 9]
 [ 9, 3, 1]
 [ 9, 1, 2]
```

`reshape` calculates that a reshaped matrix of three columns needs four rows.

Reshape Matrix Row-wise

Reshape a matrix row-wise by transposing the result.

Create matrix M.

```
syms x
M = sym([1 9 0 sin(x) 2 2; NaN x 5 1 4 7])
```

```
M =
[ 1, 9, 0, sin(x), 2, 2]
[ NaN, x, 5, 1, 4, 7]
```

Reshape M row-wise by transposing the result.

```
reshape(M,4,3) .'
ans =
[ 1, NaN, 9, x]
[ 0, 5, sin(x), 1]
[ 2, 4, 2, 7]
```

Note that `.'` returns the non-conjugate transpose while `'` returns the conjugate transpose.

Reshape 3-D Array into 2-D Matrix

Reshape the 3-by-3-by-2 array M into a 9-by-2 matrix.

M has 18 elements. Because a 9-by-2 matrix also has 18 elements, M can be reshaped into it. Construct M.

```
syms x
M = [sin(x) x 4; 3 2 9; 8 x x];
M(:,:,2) = M'
```

```
M(:,:,1) =
[ sin(x), x, 4]
[ 3, 2, 9]
[ 8, x, x]
M(:,:,2) =
[ sin(conj(x)), 3, 8]
[ conj(x), 2, conj(x)]
[ 4, 9, conj(x)]
```

Reshape M into a 9-by-2 matrix.

```
N = reshape(M,9,2)
N =
[ sin(x), sin(conj(x))]
[ 3, conj(x)]
[ 8, 4]
[ x, 3]
[ 2, 2]
[ x, 9]
[ 4, 8]
[ 9, conj(x)]
[ x, conj(x)]
```

Use reshape to Break Up Arrays

Use `reshape` instead of loops to break up arrays for further computation. Use `reshape` to break up the vector V to find the product of every three elements.

Create vector V.

```
syms x
V = [exp(x) 1 3 9 x 2 7 7 1 8 x^2 3 4 sin(x) x]

V =
[ exp(x), 1, 3, 9, x, 2, 7, 7, 1, 8, x^2, 3, 4, sin(x), x]
```

Specify 3 for the number of rows. Use the placeholder [] for the number of columns. This lets `reshape` automatically calculate the number of columns required for three rows.

```
M = prod( reshape(V,3,[]) )

M =
[ 3*exp(x), 18*x, 49, 24*x^2, 4*x*sin(x)]
```

`reshape` calculates that five columns are required for a matrix of three rows. `prod` then multiplies the elements of each column to return the result.

Input Arguments

A — Input array

symbolic vector | symbolic matrix | symbolic multidimensional array

Input array, specified as a symbolic vector, matrix, or multidimensional array.

n1, n2 — Dimensions of reshaped matrix

comma-separated scalars

Dimensions of reshaped matrix, specified as comma-separated scalars. For example, `reshape(A,3,2)` returns a 3-by-2 matrix. The number of elements in the output array specified by `n1, n2` must be equal to `numel(A)`.

n1, ..., nM — Dimensions of reshaped array

comma-separated scalars

Dimensions of reshaped array, specified as comma-separated scalars. For example, `reshape(A,3,2,2)` returns a 3-by-2-by-2 matrix. The number of elements in the output array specified by `n1, ..., nM` must be equal to `numel(A)`.

sz — Size of reshaped array

numeric vector

Size of reshaped array, specified as a numeric vector. For example, `reshape(A,[3 2])` returns a 3-by-2 matrix. The number of elements in the output array specified by `sz` must be equal to `numel(A)`.

See Also

`colon` | `transpose`

Introduced before R2006a

resultant

Resultant of two polynomials

Syntax

```
resultant(p,q)
resultant(p,q,var)
```

Description

`resultant(p,q)` returns the resultant of the polynomials `p` and `q` with respect to the variable found by `symvar`.

`resultant(p,q,var)` returns the resultant with respect to the variable `var`.

Examples

Resultant of Two Polynomials

Find the resultant of two polynomials.

```
syms x y
p = x^2+y;
q = x-2*y;
resultant(p,q)
```

```
ans =
4*y^2 + y
```

Find the resultant with respect to a specific variable by using the third argument.

```
resultant(p,q,y)
```

```
ans =
2*x^2 + x
```

Solve Polynomial Equations in Two Variables

If two polynomials have a common root, then the resultant must be 0 at that root. Solve polynomial equations in two variables by calculating the resultant with respect to one variable, and solving the resultant for the other variable.

First, calculate the resultant of two polynomials with respect to `x` to return a polynomial in `y`.

```
syms x y
p = y^3 - 2*x^2 + 3*x*y;
q = x^3 + 2*y^2 - 5*x^2*y;
res = resultant(p,q,x)
```

```
res =
y^9 - 35*y^8 + 44*y^6 + 126*y^5 - 32*y^4
```

Solve the resultant for y values of the roots. Avoid numerical roundoff errors by solving equations symbolically using the `solve` function. `solve` represents the solutions symbolically by using `root`.

```
yRoots = solve(res)

yRoots =
    0
    0
    0
    0
    root(z^5 - 35*z^4 + 44*z^2 + 126*z - 32, z, 1)
    root(z^5 - 35*z^4 + 44*z^2 + 126*z - 32, z, 2)
    root(z^5 - 35*z^4 + 44*z^2 + 126*z - 32, z, 3)
    root(z^5 - 35*z^4 + 44*z^2 + 126*z - 32, z, 4)
    root(z^5 - 35*z^4 + 44*z^2 + 126*z - 32, z, 5)
```

Calculate numeric values by using `vpa`.

```
vpa(yRoots)

ans =
    0
    0
    0
    0
    0.23545637976581197505601615070637
- 0.98628744767074109264070992415511 - 1.1027291033304653904984097788422i
- 0.98628744767074109264070992415511 + 1.1027291033304653904984097788422i
    1.7760440932430169904041045113342
    34.96107442233265321982129918627
```

Assume that you want to investigate the fifth root. For the fifth root, calculate the x value by substituting the y value into p and q . Then simultaneously solve the polynomials for x . Avoid numerical roundoff errors by solving equations symbolically using `solve`.

```
eqns = subs([p q], y, yRoots(5));
xRoot5 = solve(eqns,x);
```

Calculate the numeric value of the fifth root by using `vpa`.

```
root5 = vpa([xRoot5 yRoots(5)])

root5 =
[ 0.37078716473998365045397220797284, 0.23545637976581197505601615070637]
```

Verify that the root is correct by substituting `root5` into p and q . The result is 0 within roundoff error.

```
subs([p q],[x y],root5)

ans =
[ -6.313690360861895794753956010471e-41, -9.1835496157991211560057541970488e-41]
```

Input Arguments

p — Polynomial

symbolic expression | symbolic function

Polynomial, specified as a symbolic expression or function.

q – Polynomial

symbolic expression | symbolic function

Polynomial, specified as a symbolic expression or function.

var – Variable

symbolic variable

Variable, specified as a symbolic variable.

See Also

eliminate | gcd | solve

Introduced in R2018a

removeUnitSystem

Remove unit system

Syntax

```
removeUnitSystem(unitSystem)
```

Description

`removeUnitSystem(unitSystem)` removes the unit system `unitSystem`. You can remove only user-defined unit systems created with `newUnitSystem`. You cannot remove predefined unit systems listed in “Unit Systems List” on page 2-36.

Examples

Remove Unit System

Define a unit system, use the unit system to rewrite units, and then remove the unit system by using `removeUnitSystem`.

Define the unit system `mySystem` with SI base units and the derived unit kilowatt hour.

```
u = symunit;  
bunits = baseUnits('SI');  
dunits = [u.kWh];  
mySystem = newUnitSystem('mySystem',bunits,dunits)
```

```
mySystem =  
    "mySystem"
```

Convert 50,000 Joules to derived units of `mySystem` by using `rewrite` with the third argument `'Derived'`. As expected, the result is in kilowatt hour.

```
rewrite(50000*u.J,mySystem,'Derived')
```

```
ans =  
(1/72)*[kWh]
```

Remove the unit system `mySystem` by using `removeUnitSystem`.

```
removeUnitSystem(mySystem)
```

Converting units to `mySystem` now throws an error.

Input Arguments

unitSystem — Name of unit system

string | character vector

Name of the unit system, specified as a string or character vector.

See Also

[baseUnits](#) | [derivedUnits](#) | [newUnitSystem](#) | [removeUnit](#) | [rewrite](#) | [symunit](#) | [unitSystems](#)

Topics

“Units of Measurement Tutorial” on page 2-19

“Unit Conversions and Unit Systems” on page 2-39

“Units and Unit Systems List” on page 2-25

External Websites

The International System of Units (SI)

Introduced in R2017b

rewindAnimation

Rewind previously played animation objects

Syntax

```
rewindAnimation  
rewindAnimation(fig)
```

Description

`rewindAnimation` rewinds previously played animation objects by restoring the animation time parameter to its initial value. The animation objects must be created using the `f Animator` function.

`rewindAnimation(fig)` rewinds animation objects in the figure `fig`.

Examples

Rewind Animation of Moving Circle

Create an animation of a moving circle and rewind it using `rewindAnimation`.

First, create two symbolic variables, `t` and `x`. The variable `t` defines the time parameter of the animation. Use `t` to set the center of the circle at $(t, 1)$ and `x` to parameterize the perimeter of the circle within the range $[-\pi, \pi]$. Create the circle animation object using `f Animator`. Set the `x`-axis and `y`-axis to be equal length.

```
syms t x  
f Animator(@fplot,cos(x)+t,sin(x)+1,[-pi pi])  
axis equal
```

Play the animation by entering the command `playAnimation`. By default, `playAnimation` plays the animation within the range of `t` from 0 to 10. You can rewind the animation by using `rewindAnimation`. `rewindAnimation` restores the animation time parameter to its initial value at `t = 0` and shows the starting animation frame.

```
rewindAnimation
```

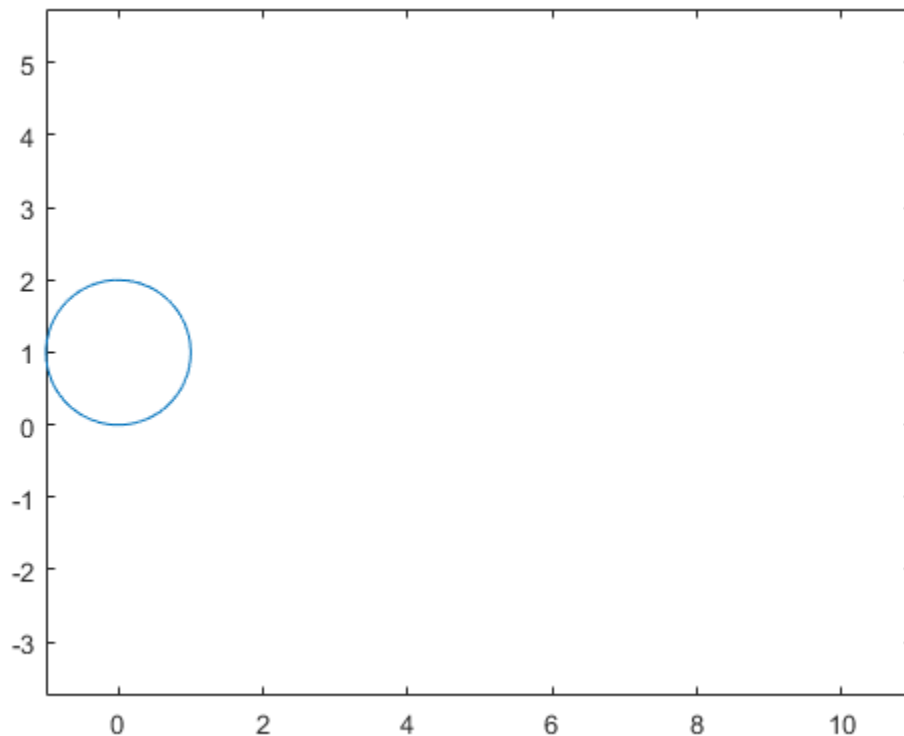

Rewind Animation of Moving Circle with Timer

Create an animation of a moving circle with a timer, and rewind the animation using `rewindAnimation`.

First, create two symbolic variables, `t` and `x`. The variable `t` defines the time parameter of the animation. Create a figure window for the animation.

```
syms t x
fig = figure;
```

Create the circle animation object using `f animator`. Use `t` to set the center of the circle at $(t, 1)$ and `x` to parameterize the perimeter of the circle within the range $[-\pi, \pi]$. Set the range of the animation time parameter to $[4, 8]$. Set the `x`-axis and `y`-axis to be equal length.

```
f animator(@fplot,cos(x)+t,sin(x)+1,[-pi pi], 'AnimationRange',[4 8])
axis equal
```

Next, add a timer animation object. Use the `text` function to create a piece of text to count the elapsed time. Use `num2str` to convert the time parameter to a string.

```
hold on
f animator(@(t) text(8,3,"Timer: "+num2str(t,2)), 'AnimationRange',[4 8])
hold off
```

Play the animation in figure `fig` between 4 and 8 seconds by entering the `playAnimation` command.

```
playAnimation(fig, 'AnimationRange', [4 8])
```

You can rewind a previously played animation by using `rewindAnimation`. `rewindAnimation` restores the animation time parameter to its initial value at `t = 4` and shows the starting animation frame.

```
rewindAnimation(fig)
```

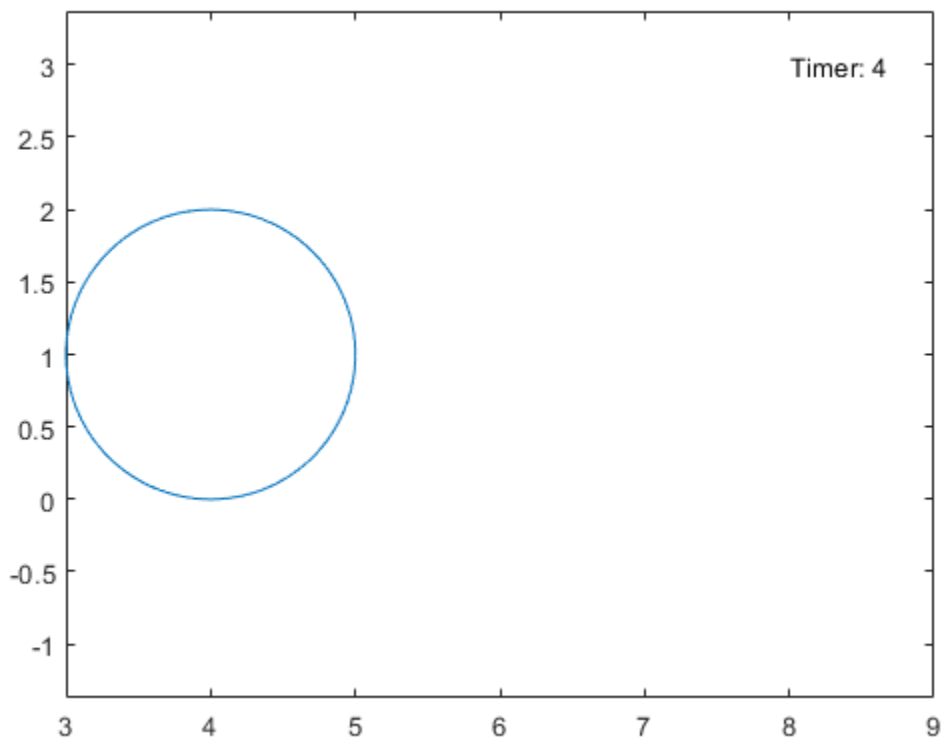

Input Arguments

fig – Target figure

Figure object

Target figure, specified as a Figure object. For more information about Figure objects, see `figure`.

See Also

`animationToFrame` | `f Animator` | `playAnimation` | `writeAnimation`

Introduced in R2019a

rewrite

Rewrite expression in terms of another function

Syntax

```
rewrite(expr, target)
```

Description

`rewrite(expr, target)` rewrites the symbolic expression `expr` in terms of the target function `target`. The rewritten expression is mathematically equivalent to the original expression. If `expr` is a vector or matrix, `rewrite` acts element-wise on `expr`.

Examples

Rewrite Between Trigonometric and Exponential Functions

Rewrite any trigonometric function in terms of the exponential function by specifying the target 'exp'.

```
syms x
sin2exp = rewrite(sin(x), 'exp')
tan2exp = rewrite(tan(x), 'exp')

sin2exp =
(exp(-x*1i)*1i)/2 - (exp(x*1i)*1i)/2

tan2exp =
-(exp(x*2i)*1i - 1i)/(exp(x*2i) + 1)
```

Rewrite the exponential function in terms of any trigonometric function by specifying the trigonometric function as the target. For a full list of targets, see `target`.

```
syms x
exp2sin = rewrite(exp(x), 'sin')
exp2tan = rewrite(-(exp(x*2i)*1i - 1i)/(exp(x*2i) + 1), 'tan')

exp2sin =
1 - 2*sin((x*1i)/2)^2 - sin(x*1i)*1i
exp2tan =
-(((tan(x) - 1i)*1i)/(tan(x) + 1i) + 1i)/...
  ((tan(x) - 1i)/(tan(x) + 1i) - 1)
```

Simplify `exp2tan` into the expected form by using `simplify`.

```
exp2tan = simplify(exp2tan)

exp2tan =
tan(x)
```

Rewrite Between Trigonometric Functions

Rewrite any trigonometric function in terms of any other trigonometric function by specifying the target. For a full list of targets, see `target`.

Rewrite $\tan(x)$ in terms of the sine function by specifying the target 'sin'.

```
syms x
tan2sin = rewrite(tan(x), 'sin')

tan2sin =
-sin(x)/(2*sin(x/2)^2 - 1)
```

Rewrite Between Hyperbolic Functions and Trigonometric Functions

Rewrite any hyperbolic function in terms of any trigonometric function by specifying the trigonometric function as the target. For a full list of targets, see `target`.

Rewrite $\tanh(x)$ in terms of the sine function by specifying the target 'sin'.

```
syms x
tanh2sin = rewrite(tanh(x), 'sin')

tanh2sin =
(sin(x*1i)*1i)/(2*sin((x*1i)/2)^2 - 1)
```

Similarly, rewrite trigonometric functions in terms of hyperbolic functions by specifying the hyperbolic function as the target.

Rewrite Between Inverse Trigonometric Functions and Logarithm Function

Rewrite any inverse trigonometric function in terms of the logarithm function by specifying the target 'log'. For a full list of targets, see `target`.

Rewrite $\arccos(x)$ and $\operatorname{acot}(x)$ in terms of the log function.

```
syms x
acos2log = rewrite(acos(x), 'log')
acot2log = rewrite(acot(x), 'log')

acos2log =
-log(x + (1 - x^2)^(1/2)*1i)*1i

acot2log =
(log(1 - 1i/x)*1i)/2 - (log(1i/x + 1)*1i)/2
```

Similarly, rewrite the logarithm function in terms of an inverse trigonometric function by specifying the inverse trigonometric function as the target.

Rewrite Elements of Matrix

Rewrite each element of a matrix by calling `rewrite` on the matrix.

Rewrite all elements of a matrix in terms of the `exp` function.

```
syms x
matrix = [sin(x) cos(x); sinh(x) cosh(x)];
rewrite(matrix, 'exp')

ans =
[ (exp(-x*1i)*1i)/2 - (exp(x*1i)*1i)/2, exp(-x*1i)/2 + exp(x*1i)/2]
[ exp(x)/2 - exp(-x)/2, exp(-x)/2 + exp(x)/2]
```

Rewrite Between Sine and Cosine Functions

Rewrite the cosine function in terms of the sine function. Here, `rewrite` replaces the cosine function using the identity $\cos(2*x) = 1 - 2*\sin(x)^2$ which is valid for any x .

```
syms x
rewrite(cos(x), 'sin')

ans =
1 - 2*sin(x/2)^2
```

`rewrite` does not replace $\sin(x)$ with either $-\sqrt{1 - \cos^2(x)}$ or $\sqrt{1 - \cos^2(x)}$ because these expressions are not valid for all x . However, using the square of these expressions to replace $\sin(x)^2$ is valid for all x . Thus, `rewrite` replaces $\sin(x)^2$.

```
syms x
rewrite(sin(x), 'cos')
rewrite(sin(x)^2, 'cos')

ans =
sin(x)
ans =
1 - cos(x)^2
```

Input Arguments

expr – Input to rewrite

symbolic number | symbolic variable | symbolic expression | symbolic function | symbolic vector | symbolic matrix | symbolic multidimensional array

Input to `rewrite`, specified as a symbolic number, variable, expression, function, vector, matrix, or multidimensional array.

target – Target function

character vector

Target function, specified as a character vector. This table summarizes the rewriting rules for all allowed targets.

Target	Rewrites These Functions	In Terms of These Functions
'exp'	All trigonometric and hyperbolic functions including inverse functions	exp, log

Target	Rewrites These Functions	In Terms of These Functions
'log'	All inverse trigonometric and hyperbolic functions	log
'sincos'	tan, cot, exp, sinh, cosh, tanh, coth	sin, cos
'sin', 'cos', 'tan', or 'cot'	sin, cos, exp, tan, cot, sinh, cosh, tanh, coth except the target	Target trigonometric function
'sinhcosh'	tan, cot, exp, sin, cos, tanh, coth	sinh, cosh
'sinh', 'cosh', 'tanh', 'coth'	tan, cot, exp, sin, cos, sinh, cosh, tanh, coth except the target	Target hyperbolic function
'asin', 'acos', 'atan', 'acot'	log, and all inverse trigonometric and inverse hyperbolic functions	Target inverse trigonometric function
'asinh', 'acosh', 'atanh', 'acoth'	log, and all inverse trigonometric and inverse hyperbolic functions	Target inverse hyperbolic function
'sqrt'	$\text{abs}(x + \text{li}*y)$	$\text{sqrt}(x^2 + y^2)$
'heaviside'	sign, triangularPulse, rectangularPulse	heaviside
'piecewise'	abs, heaviside, sign, triangularPulse, rectangularPulse	piecewise

Tips

- `rewrite` replaces symbolic function calls in `expr` with the target function only if the replacement is mathematically valid. Otherwise, it keeps the original function calls.

See Also

Functions

`collect` | `combine` | `expand` | `factor` | `horner` | `numden` | `simplify` | `simplifyFraction` | `unitConvert`

Live Editor Tasks

Simplify Symbolic Expression

Topics

“Choose Function to Rearrange Expression” on page 2-104

“Simplify Symbolic Expressions Using Live Editor Task” on page 2-94

Introduced in R2012a

rhs

Right side (RHS) of equation

Syntax

```
rhs(eqn)
```

Description

`rhs(eqn)` returns the right side of the symbolic equation `eqn`. The value of `eqn` also can be a symbolic condition, such as $x > 0$. If `eqn` is an array, then `rhs` returns an array of the right sides of the equations in `eqn`.

Examples

Find Right Side of Equation

Find the right side of the equation $2*y == x^2$ by using `rhs`.

First, declare the equation.

```
syms x y
eqn = 2*y == x^2
```

```
eqn =
2*y == x^2
```

Find the right side of `eqn` by using `rhs`.

```
rhsEqn = rhs(eqn)
```

```
rhsEqn =
x^2
```

Find Right Side of Condition

Find the right side of the condition $x < y + 1$ by using `rhs`.

First, declare the condition.

```
syms x y
cond = x < y + 1
```

```
cond =
x < y + 1
```

Find the right side of `cond` by using `rhs`.

```
rhsCond = rhs(cond)
```

```
rhsCond =
y + 1
```

Note Conditions that use the $>$ operator are internally rewritten using the $<$ operator. Therefore, `rhs` returns the original left side. For example, `rhs(x > a)` returns `x`.

Find Right Side of Equations in Array

For an array that contains equations and conditions, `rhs` returns an array of the right sides of those equations or conditions. The output array is the same size as the input array.

Find the right side of the equations and conditions in the vector `V`.

```
syms x y
V = [y^2 == x^2, x ~= 0, x*y >= 1]
```

```
V =
[ y^2 == x^2, x ~= 0, 1 <= x*y]
```

```
rhsV = rhs(V)
```

```
rhsV =
[ x^2, 0, x*y]
```

Because any condition using the $>=$ operator is internally rewritten using the $<=$ operator, the sides of the last condition in `V` are exchanged.

Input Arguments

eqn — Equation or condition

symbolic equation | symbolic condition | vector of symbolic equations or conditions | matrix of symbolic equations or conditions | multidimensional array of symbolic equations or conditions

Equation or condition, specified as a symbolic equation or condition, or a vector, matrix, or multidimensional array of symbolic equations or conditions.

See Also

`assume` | `children` | `lhs` | `subs`

Introduced in R2017a

root

Represent roots of polynomial

Syntax

```
root(p,x)
root(p,x,k)
```

Description

`root(p,x)` returns a column vector of numbered roots of symbolic polynomial p with respect to x . Symbolically solving a high-degree polynomial for its roots can be complex or mathematically impossible. In this case, the Symbolic Math Toolbox uses the `root` function to represent the roots of the polynomial.

`root(p,x,k)` represents the k th root of symbolic polynomial p with respect to x .

Examples

Represent Roots of High-Degree Polynomial

Represent the roots of the polynomial $x^3 + 1$ using `root`. The `root` function returns a column vector. The elements of this vector represent the three roots of the polynomial.

```
syms x
p = x^3 + 1;
root(p,x)

ans =
    root(x^3 + 1, x, 1)
    root(x^3 + 1, x, 2)
    root(x^3 + 1, x, 3)
```

`root(x^3 + 1, x, 1)` represents the first root of p , while `root(x^3 + 1, x, 2)` represents the second root, and so on. Use this syntax to represent roots of high-degree polynomials.

Find Roots of High-Degree Polynomial

When solving a high-degree polynomial, `solve` represents the roots by using `root`. Alternatively, you can either return an explicit solution by using the `MaxDegree` option or return a numerical result by using `vpa`.

Find the roots of $x^3 + 3x - 16$.

```
syms x
p = x^3 + 3*x - 16;
R = solve(p,x)

R =
    root(z^3 + 3*z - 16, z, 1)
    root(z^3 + 3*z - 16, z, 2)
    root(z^3 + 3*z - 16, z, 3)
```

Find the roots explicitly by setting the `MaxDegree` option to the degree of the polynomial. Polynomials with a degree greater than 4 do not have explicit solutions.

```
Rexplicit = solve(p,x,'MaxDegree',3)
```

```
Rexplicit =
      (65^(1/2) + 8)^(1/3) - 1/(65^(1/2) + 8)^(1/3)
1/(2*(65^(1/2) + 8)^(1/3)) - (65^(1/2) + 8)^(1/3)/2 - ...
(3^(1/2)*(1/(65^(1/2) + 8)^(1/3) + (65^(1/2) + 8)^(1/3))*1i)/2
1/(2*(65^(1/2) + 8)^(1/3)) - (65^(1/2) + 8)^(1/3)/2 + ...
(3^(1/2)*(1/(65^(1/2) + 8)^(1/3) + (65^(1/2) + 8)^(1/3))*1i)/2
```

Calculate the roots numerically by using `vpa` to convert `R` to high-precision floating point.

```
Rnumeric = vpa(R)
```

```
RRnumeric =
      2.1267693318103912337456401562601
- 1.0633846659051956168728200781301 - 2.5283118563671914055545884653776i
- 1.0633846659051956168728200781301 + 2.5283118563671914055545884653776i
```

If the call to `root` contains parameters, substitute the parameters with numbers by using `subs` before calling `vpa`.

Use root in Symbolic Computations

You can use the `root` function as input to Symbolic Math Toolbox functions such as `simplify`, `subs`, and `diff`.

Simplify an expression containing `root` using the `simplify` function.

```
syms x
r = root(x^6 + x, x, 1);
simplify(sin(r)^2 + cos(r)^2)
```

```
ans =
1
```

Substitute for parameters in `root` with numbers using `subs`.

```
syms b
subs(root(x^2 + b*x, x, 1), b, 5)
```

```
ans =
root(x^2 + 5*x, x, 1)
```

Substituting for parameters using `subs` is necessary before converting `root` to numeric form using `vpa`.

Differentiate an expression containing `root` with respect to a parameter using `diff`.

```
diff(root(x^2 + b*x, x, 1), b)
```

```
ans =
root(b^2*x^2 + b^2*x, x, 1)
```

Find Inverse Laplace Transform of Ratio of Polynomials

Find the inverse Laplace transform of a ratio of two polynomials using `ilaplace`. The inverse Laplace transform is returned in terms of `root`.

```
syms s
G = (s^3 + 1)/(s^6 + s^5 + s^2);
H = ilaplace(G)

H =
t - symsum(exp(t*root(s3^4 + s3^3 + 1, s3, k))/...
(4*root(s3^4 + s3^3 + 1, s3, k) + 3), k, 1, 4)
```

When you get the `root` function in output, you can use the `root` function as input in subsequent symbolic calculations. However, if a numerical result is required, convert the `root` function to a high-precision numeric result using `vpa`.

Convert the inverse Laplace transform to numeric form using `vpa`.

```
H_vpa = simplify(vpa(H))

H_vpa =
t +...
0.30881178580997278695808136329347*exp(-1.0189127943851558447865795886366*t)*...
cos(0.60256541999859902604398442197193*t) -...
0.30881178580997278695808136329347*exp(0.5189127943851558447865795886366*t)*...
cos(0.666609844932018579153758800733*t) -...
0.6919689479355443779463355813596*exp(-1.0189127943851558447865795886366*t)*...
sin(0.60256541999859902604398442197193*t) -...
0.16223098826244593894459034019473*exp(0.5189127943851558447865795886366*t)*...
sin(0.666609844932018579153758800733*t)
```

Input Arguments

p — Symbolic polynomial

symbolic expression

Symbolic polynomial, specified as a symbolic expression.

x — Variable

symbolic variable

Variable, specified as a symbolic variable.

k — Number of polynomial root

number | vector | matrix | multidimensional array | symbolic number | symbolic vector | symbolic matrix | symbolic multidimensional array

Number of polynomial root, specified as a number, vector, matrix, multidimensional array, or a symbolic number, vector, matrix, or multidimensional array. When `k` is a nonscalar, `root` acts element-wise on `k`.

Example: `root(f, x, 3)` represents the third root of `f`.

See Also

`solve` | `vpa`

Introduced in R2015b

rref

Reduced row echelon form of matrix (Gauss-Jordan elimination)

Syntax

`rref(A)`

Description

`rref(A)` computes the reduced row echelon form of the symbolic matrix `A`. If the elements of a matrix contain free symbolic variables, `rref` regards the matrix as nonzero.

To solve a system of linear equations, use `linsolve`.

Examples

Compute Reduced Row Echelon Form of Numeric Matrix

Compute the reduced row echelon form of the magic square matrix.

```
rref(sym(magic(4)))
```

```
ans =
[ 1, 0, 0, 1]
[ 0, 1, 0, 3]
[ 0, 0, 1, -3]
[ 0, 0, 0, 0]
```

Compute Reduced Row Echelon Form of Symbolic Matrix

Compute the reduced row echelon form of the following symbolic matrix.

```
syms a b c
A = [a b c; b c a; a + b, b + c, c + a];
rref(A)
```

```
ans =
[ 1, 0, -(- c^2 + a*b)/(- b^2 + a*c)]
[ 0, 1, -(- a^2 + b*c)/(- b^2 + a*c)]
[ 0, 0, 0]
```

See Also

`eig` | `jordan` | `linsolve` | `rank`

Introduced before R2006a

rsums

Interactive evaluation of Riemann sums

Syntax

```
rsums(f)
rsums(f, a, b)
rsums(f, [a, b])
```

Description

`rsums(f)` interactively approximates the integral of $f(x)$ by middle Riemann sums for x from 0 to 1. `rsums(f)` displays a graph of $f(x)$ using 10 terms (rectangles). You can adjust the number of terms taken in the middle Riemann sum by using the slider below the graph. The number of terms available ranges from 2 to 128. f can be a character vector or a symbolic expression. The height of each rectangle is determined by the value of the function in the middle of each interval.

`rsums(f, a, b)` and `rsums(f, [a, b])` approximates the integral for x from a to b .

Examples

Approximate Integral by Riemann Sum

Approximate the integral $\int_0^1 x^2 dx$ by middle Riemann sum. `rsums` displays a graph of x^2 using 10 terms of the midpoint Riemann sum for the integration range from 0 to 1. The total sum is 0.3325.

```
syms x
rsums(x^2)
```

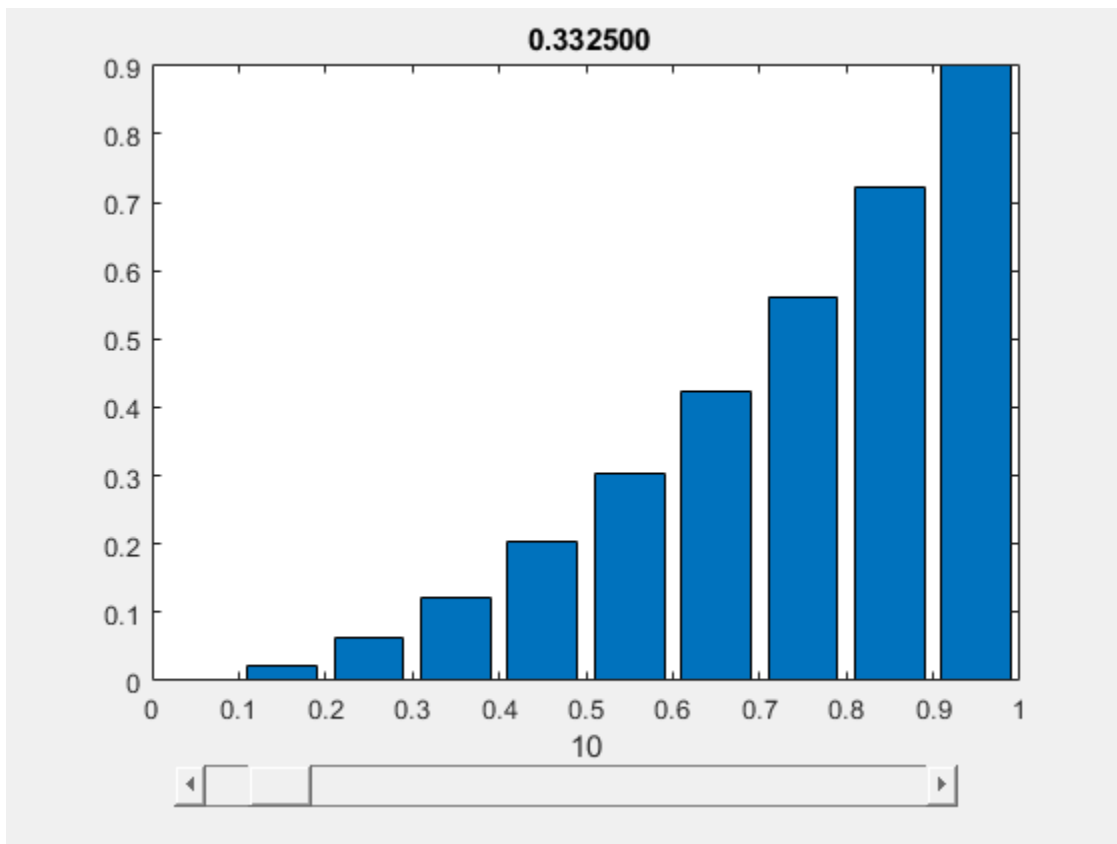
Change the integration range of x from -2 to 5. The total Riemann sum is 44.0475.

`rsums(x^2, -2, 5)`

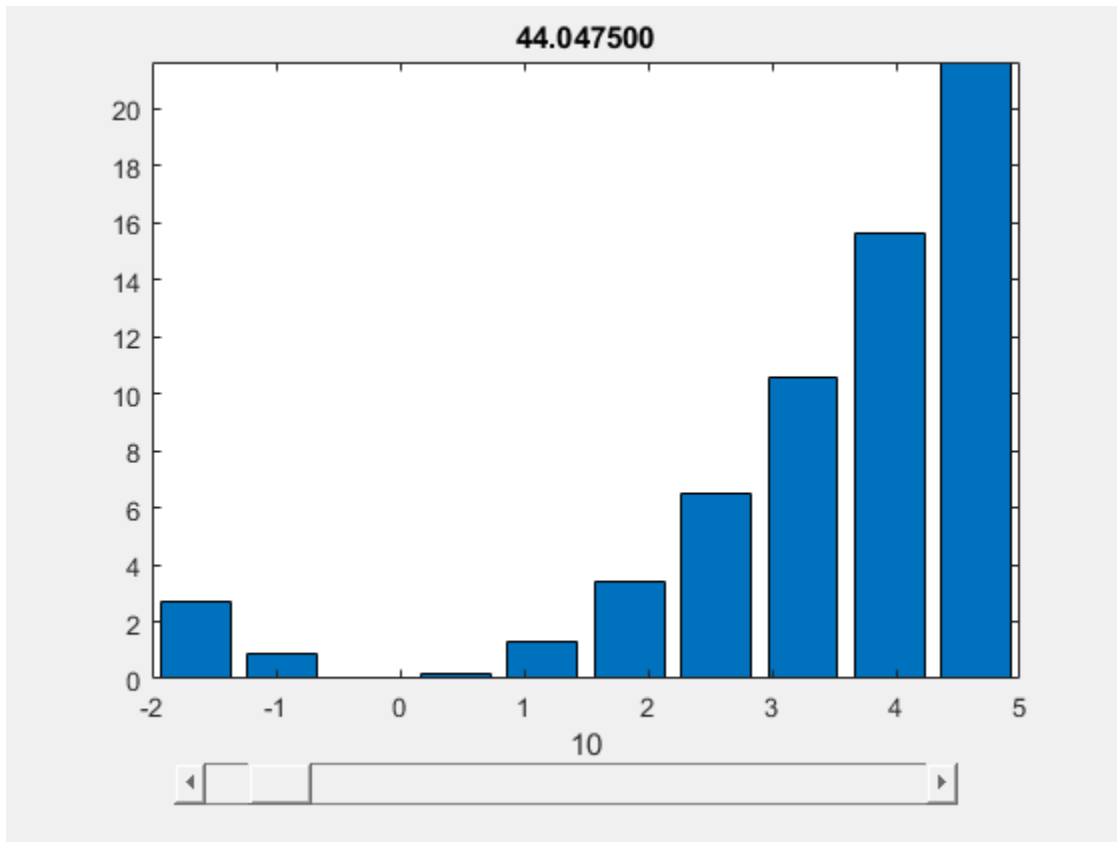

Input Arguments

f – Integrand

symbolic expression | symbolic function | symbolic number

Integrand, specified as a symbolic expression, function, or number.

a – Lower bound

number | symbolic number

Lower bound, specified as a number or symbolic number.

b – Upper bound

number | symbolic number

Upper bound, specified as a number or symbolic number.

See Also

`funtool` | `int` | `taylortool`

Introduced before R2006a

sec

Symbolic secant function

Syntax

`sec(X)`

Description

`sec(X)` returns the secant function on page 4-1191 of X.

Examples

Secant Function for Numeric and Symbolic Arguments

Depending on its arguments, `sec` returns floating-point or exact symbolic results.

Compute the secant function for these numbers. Because these numbers are not symbolic objects, `sec` returns floating-point results.

```
A = sec([-2, -pi, pi/6, 5*pi/7, 11])
```

```
A =
    -2.4030    -1.0000     1.1547    -1.6039    225.9531
```

Compute the secant function for the numbers converted to symbolic objects. For many symbolic (exact) numbers, `sec` returns unresolved symbolic calls.

```
symA = sec(sym([-2, -pi, pi/6, 5*pi/7, 11]))
```

```
symA =
[ 1/cos(2), -1, (2*3^(1/2))/3, -1/cos((2*pi)/7), 1/cos(11)]
```

Use `vpa` to approximate symbolic results with floating-point numbers:

```
vpa(symA)
```

```
ans =
[ -2.4029979617223809897546004014201, ...
  -1.0, ...
  1.1547005383792515290182975610039, ...
  -1.6038754716096765049444092780298, ...
  225.95305931402493269037542703557]
```

Plot Secant Function

Plot the secant function on the interval from -4π to 4π .

```
syms x
fplot(sec(x),[-4*pi 4*pi])
grid on
```

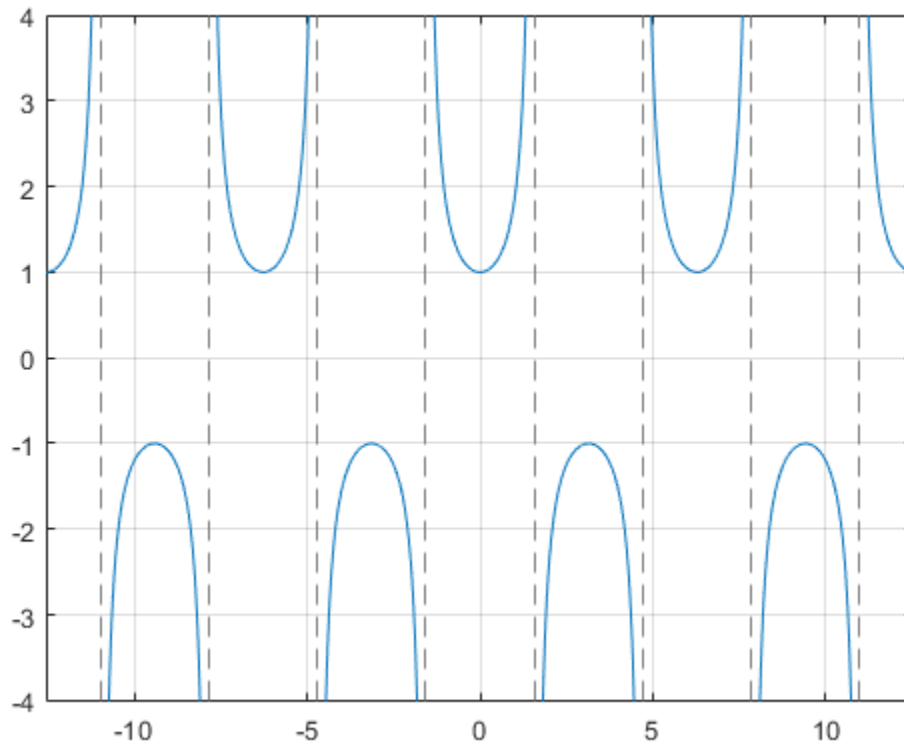

Handle Expressions Containing Secant Function

Many functions, such as `diff`, `int`, `taylor`, and `rewrite`, can handle expressions containing `sec`.

Find the first and second derivatives of the secant function:

```
syms x
diff(sec(x), x)
diff(sec(x), x, x)
```

```
ans =
sin(x)/cos(x)^2
```

```
ans =
1/cos(x) + (2*sin(x)^2)/cos(x)^3
```

Find the indefinite integral of the secant function:

```
int(sec(x), x)
```

```
ans =
log(1/cos(x)) + log(sin(x) + 1)
```

Find the Taylor series expansion of `sec(x)`:

```
taylor(sec(x), x)
```

```
ans =
(5*x^4)/24 + x^2/2 + 1
```

Rewrite the secant function in terms of the exponential function:

```
rewrite(sec(x), 'exp')
```

```
ans =
1/(exp(-x*1i)/2 + exp(x*1i)/2)
```

Evaluate Units with sec Function

sec numerically evaluates these units automatically: radian, degree, arcmin, arcsec, and revolution.

Show this behavior by finding the secant of x degrees and 2 radians.

```
u = symunit;
syms x
f = [x*u.degree 2*u.radian];
secf = sec(f)

secf =
[ 1/cos((pi*x)/180), 1/cos(2)]
```

You can calculate secf by substituting for x using subs and then using double or vpa.

Input Arguments

X — Input

symbolic number | symbolic variable | symbolic expression | symbolic function | symbolic vector | symbolic matrix

Input, specified as a symbolic number, variable, expression, or function, or as a vector or matrix of symbolic numbers, variables, expressions, or functions.

More About

Secant Function

The secant of an angle, α , defined with reference to a right angled triangle is

$$\sec(\alpha) = \frac{1}{\cos(\alpha)} = \frac{\text{hypotenuse}}{\text{adjacent side}} = \frac{h}{b}.$$

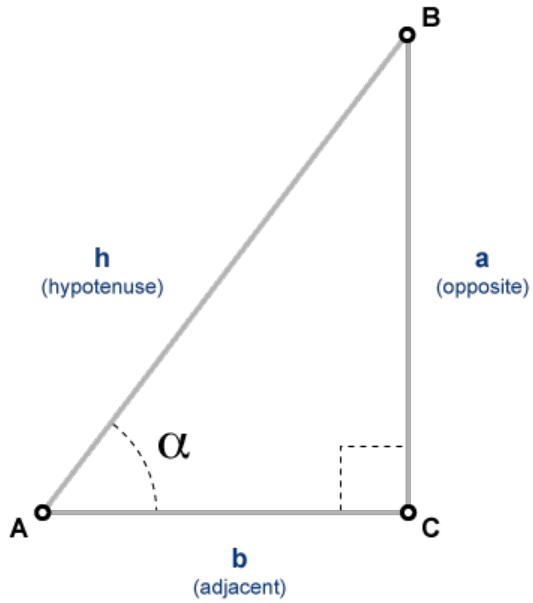

The secant of a complex argument, α , is

$$\sec(\alpha) = \frac{2}{e^{i\alpha} + e^{-i\alpha}} .$$

See Also

acos | acot | acsc | asec | asin | atan | cos | cot | csc | sin | tan

Introduced before R2006a

sech

Symbolic hyperbolic secant function

Syntax

`sech(X)`

Description

`sech(X)` returns the hyperbolic secant function of X .

Examples

Hyperbolic Secant Function for Numeric and Symbolic Arguments

Depending on its arguments, `sech` returns floating-point or exact symbolic results.

Compute the hyperbolic secant function for these numbers. Because these numbers are not symbolic objects, `sech` returns floating-point results.

```
A = sech([-2, -pi*i, pi*i/6, 0, pi*i/3, 5*pi*i/7, 1])
```

```
A =
    0.2658    -1.0000    1.1547    1.0000    2.0000    -1.6039    0.6481
```

Compute the hyperbolic secant function for the numbers converted to symbolic objects. For many symbolic (exact) numbers, `sech` returns unresolved symbolic calls.

```
symA = sech(sym([-2, -pi*i, pi*i/6, 0, pi*i/3, 5*pi*i/7, 1]))
```

```
symA =
[ 1/cosh(2), -1, (2*3^(1/2))/3, 1, 2, -1/cosh((pi*2i)/7), 1/cosh(1)]
```

Use `vpa` to approximate symbolic results with floating-point numbers:

```
vpa(symA)
```

```
ans =
[ 0.26580222883407969212086273981989, ...
 -1.0, ...
 1.1547005383792515290182975610039, ...
 1.0, ...
 2.0, ...
 -1.6038754716096765049444092780298, ...
 0.64805427366388539957497735322615]
```

Plot Hyperbolic Secant Function

Plot the hyperbolic secant function on the interval from -10 to 10.

```
syms x
fplot(sech(x), [-10, 10])
grid on
```

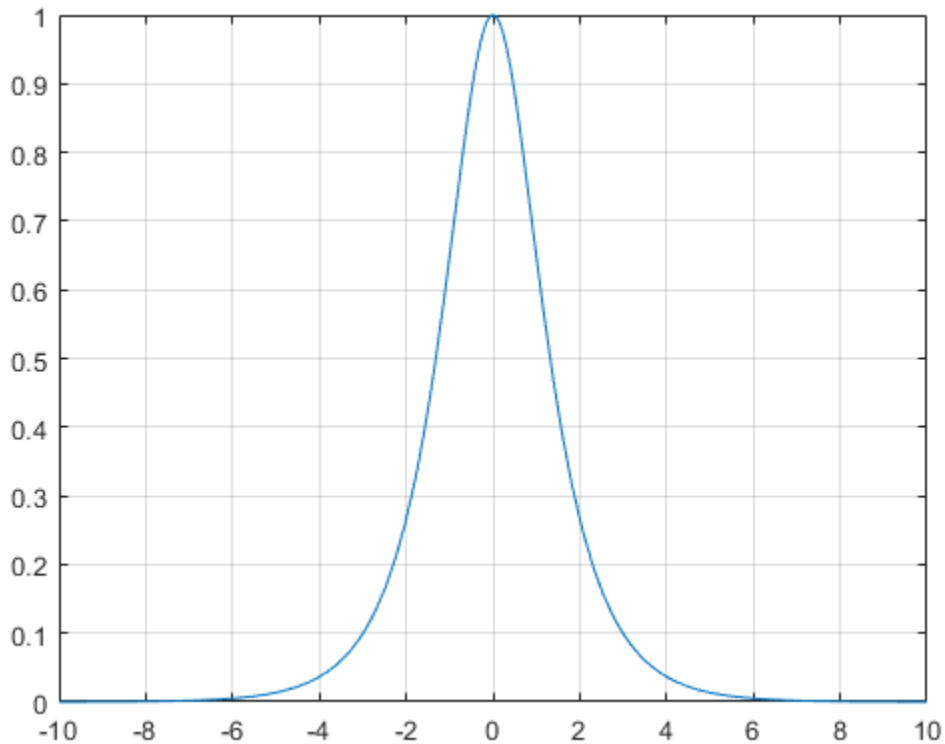

Handle Expressions Containing Hyperbolic Secant Function

Many functions, such as `diff`, `int`, `taylor`, and `rewrite`, can handle expressions containing `sech`.

Find the first and second derivatives of the hyperbolic secant function:

```
syms x
diff(sech(x), x)
diff(sech(x), x, x)
```

```
ans =
-sinh(x)/cosh(x)^2
```

```
ans =
(2*sinh(x)^2)/cosh(x)^3 - 1/cosh(x)
```

Find the indefinite integral of the hyperbolic secant function:

```
int(sech(x), x)
```

```
ans =
2*atan(exp(x))
```

Find the Taylor series expansion of `sech(x)`:

```
taylor(sech(x), x)
```



```
ans =  
(5*x^4)/24 - x^2/2 + 1
```

Rewrite the hyperbolic secant function in terms of the exponential function:

```
rewrite(sech(x), 'exp')
```

```
ans =  
1/(exp(-x)/2 + exp(x)/2)
```

Input Arguments

X — Input

symbolic number | symbolic variable | symbolic expression | symbolic function | symbolic vector | symbolic matrix

Input, specified as a symbolic number, variable, expression, or function, or as a vector or matrix of symbolic numbers, variables, expressions, or functions.

See Also

acosh | acoth | acsch | asech | asinh | atanh | cosh | coth | csch | sinh | tanh

Introduced before R2006a

separateUnits

Separate units from expression

Syntax

```
[Data,Units] = separateUnits(expr)
Data = separateUnits(expr)
```

Description

`[Data,Units] = separateUnits(expr)` returns the units of the symbolic expression `expr` in `Units` and the rest of `expr` in `Data`.

`Data = separateUnits(expr)` removes symbolic units from `expr` and then returns the rest.

Examples

Separate Units and Expression

Separate the units from the expression $10*t*u.m/u.s$, where `u = symunit`, by providing two output arguments for `separateUnits`.

```
u = symunit;
syms t
speed = 10*t*u.m/u.s;
[Data,Units] = separateUnits(speed)
```

```
Data =
10*t
Units =
1*([m]/[s])
```

Return only the expression with the units removed by providing one output argument.

```
Data = separateUnits(speed)
```

```
Data =
10*t
```

Separate Incompatible Units

When the expression has incompatible units, `separateUnits` errors. Units are incompatible when they do not have the same dimensions, such as length or time.

Separate the units from $2*u.m + 3*u.s$, where `u = symunit`. The `separateUnits` function throws an error. Instead, to list the units in the input, use `findUnits`.

```
u = symunit;
[Data,Units] = separateUnits(2*u.m + 3*u.s)
```

```
Error using separateUnits (line 52)
Argument has incompatible units.
```

Separate Inconsistent Units

When the input has inconsistent units that can be converted to the same unit, then `separateUnits` performs the conversion and returns the separated result. Units are inconsistent when they cannot be converted to each other with a conversion factor of 1

Separate the units from $2*u.m + 30*u.cm$. Even though the units differ, `separateUnits` converts them to the same unit and returns the separated result.

```
u = symunit;
[Data,Units] = separateUnits(2*u.m + 30*u.cm)
```

```
Data =
230
Units =
[cm]
```

Input Arguments

expr — Input

number | vector | matrix | multidimensional array | symbolic number | symbolic variable | symbolic vector | symbolic matrix | symbolic multidimensional array | symbolic function | symbolic expression

Input, returned as a number, vector, matrix or multidimensional array, or a symbolic number, variable, vector, matrix, multidimensional array, function, or expression.

Output Arguments

Data — Expression after removing units

number | vector | matrix | multidimensional array | symbolic number | symbolic variable | symbolic vector | symbolic matrix | symbolic equation | symbolic multidimensional array | symbolic function | symbolic expression

Expression after removing units, returned as a number, vector, matrix or multidimensional array, or a symbolic number, variable, vector, matrix, equation, multidimensional array, function, or expression.

Units — Units from input

symbolic units

Units from input, specified as symbolic units.

See Also

`checkUnits` | `findUnits` | `isUnit` | `newUnit` | `str2symunit` | `symunit` | `symunit2str` | `unitConversionFactor`

Topics

“Units of Measurement Tutorial” on page 2-19
 “Unit Conversions and Unit Systems” on page 2-39
 “Units and Unit Systems List” on page 2-25

External Websites

The International System of Units (SI)

Introduced in R2017a

series

Puiseux series

Syntax

```
series(f,var)
series(f,var,a)
series( ____,Name,Value)
```

Description

`series(f,var)` approximates f with the Puiseux series expansion of f up to the fifth order at the point $\text{var} = 0$. If you do not specify `var`, then `series` uses the default variable determined by `symvar(f,1)`.

`series(f,var,a)` approximates f with the Puiseux series expansion of f at the point $\text{var} = a$.

`series(____,Name,Value)` uses additional options specified by one or more `Name,Value` pair arguments. You can specify `Name,Value` after the input arguments in any of the previous syntaxes.

Examples

Find Puiseux Series Expansion

Find the Puiseux series expansions of univariate and multivariate expressions.

Find the Puiseux series expansion of this expression at the point $x = 0$.

```
syms x
series(1/sin(x), x)

ans =
x/6 + 1/x + (7*x^3)/360
```

Find the Puiseux series expansion of this multivariate expression. If you do not specify the expansion variable, `series` uses the default variable determined by `symvar(f,1)`.

```
syms s t
f = sin(s)/sin(t);
symvar(f, 1)
series(f)

ans =
t

ans =
sin(s)/t + (7*t^3*sin(s))/360 + (t*sin(s))/6
```

To use another expansion variable, specify it explicitly.

```
syms s t
f = sin(s)/sin(t);
series(f, s)
```

```
ans =
s^5/(120*sin(t)) - s^3/(6*sin(t)) + s/sin(t)
```

Specify Expansion Point

Find the Puiseux series expansion of $\text{psi}(x)$ around $x = \text{Inf}$. The default expansion point is 0. To specify a different expansion point, use the `ExpansionPoint` name-value pair.

```
series(psi(x), x, 'ExpansionPoint', Inf)
```

```
ans =
log(x) - 1/(2*x) - 1/(12*x^2) + 1/(120*x^4)
```

Alternatively, specify the expansion point as the third argument of `series`.

```
syms x
series(psi(x), x, Inf)
```

```
ans =
log(x) - 1/(2*x) - 1/(12*x^2) + 1/(120*x^4)
```

Specify Truncation Order

Find the Puiseux series expansion of $\exp(x)/x$ using different truncation orders.

Find the series expansion up to the default truncation order 6.

```
syms x
f = exp(x)/x;
s6 = series(f, x)
```

```
s6 =
x/2 + 1/x + x^2/6 + x^3/24 + x^4/120 + 1
```

Use `Order` to control the truncation order. For example, approximate the same expression up to the orders 7 and 8.

```
s7 = series(f, x, 'Order', 7)
s8 = series(f, x, 'Order', 8)
```

```
s7 =
x/2 + 1/x + x^2/6 + x^3/24 + x^4/120 + x^5/720 + 1
```

```
s8 =
x/2 + 1/x + x^2/6 + x^3/24 + x^4/120 + x^5/720 + x^6/5040 + 1
```

Plot the original expression `f` and its approximations `s6`, `s7`, and `s8`. Note how the accuracy of the approximation depends on the truncation order.

```
fplot([s6 s7 s8 f])
legend('approximation up to 0(x^6)', 'approximation up to 0(x^7)', ...
      'approximation up to 0(x^8)', 'exp(x)/x', 'Location', 'Best')
title('Puiseux Series Expansion')
```

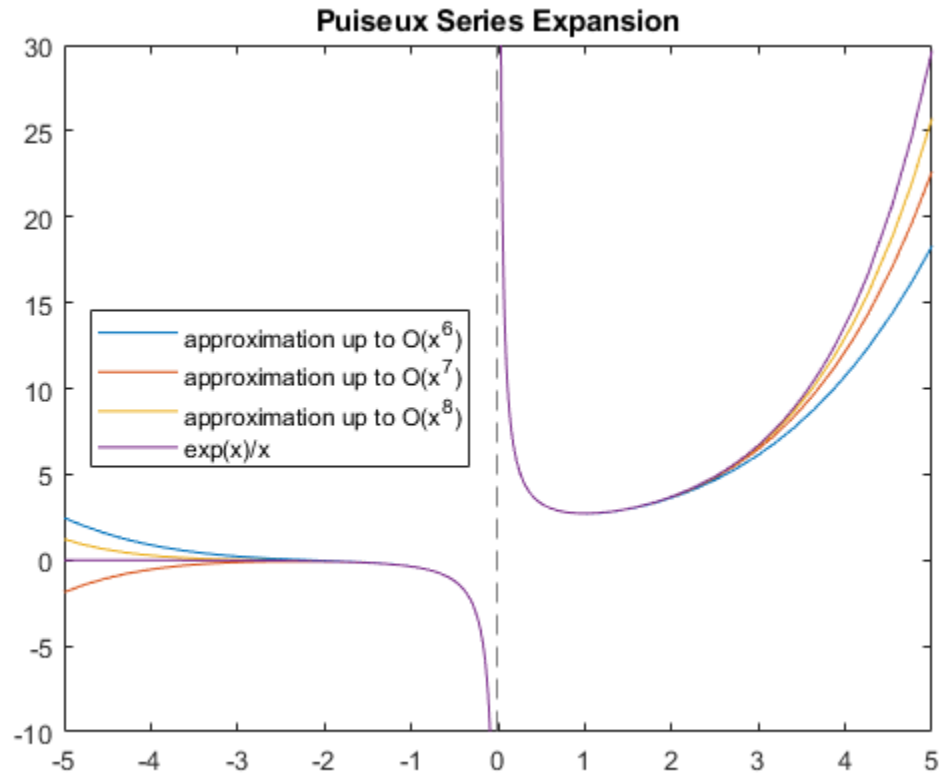

Specify Direction of Expansion

Find the Puiseux series approximations using the `Direction` argument. This argument lets you change the convergence area, which is the area where `series` tries to find converging Puiseux series expansion approximating the original expression.

Find the Puiseux series approximation of this expression. By default, `series` finds the approximation that is valid in a small open circle in the complex plane around the expansion point.

```
syms x
series(sin(sqrt(-x)), x)

ans =
(-x)^(1/2) - (-x)^(3/2)/6 + (-x)^(5/2)/120
```

Find the Puiseux series approximation of the same expression that is valid in a small interval to the left of the expansion point. Then, find an approximation that is valid in a small interval to the right of the expansion point.

```
syms x
series(sin(sqrt(-x)), x)
series(sin(sqrt(-x)), x, 'Direction', 'left')
series(sin(sqrt(-x)), x, 'Direction', 'right')

ans =
(-x)^(1/2) - (-x)^(3/2)/6 + (-x)^(5/2)/120
```

```
ans =
- x^(1/2)*1i - (x^(3/2)*1i)/6 - (x^(5/2)*1i)/120
```

```
ans =
x^(1/2)*1i + (x^(3/2)*1i)/6 + (x^(5/2)*1i)/120
```

Try computing the Puiseux series approximation of this expression. By default, `series` tries to find an approximation that is valid in the complex plane around the expansion point. For this expression, such approximation does not exist.

```
series(real(sin(x)), x)
```

```
Error using sym/series>scalarSeries (line 90)
Cannot compute a series expansion of the input.
```

However, the approximation exists along the real axis, to both sides of $x = 0$.

```
series(real(sin(x)), x, 'Direction', 'realAxis')
```

```
ans =
x^5/120 - x^3/6 + x
```

Input Arguments

f — Input to approximate

symbolic expression | symbolic function | symbolic vector | symbolic matrix | symbolic multidimensional array

Input to approximate, specified as a symbolic expression or function. It also can be a vector, matrix, or multidimensional array of symbolic expressions or functions.

var — Expansion variable

symbolic variable

Expansion variable, specified as a symbolic variable. If you do not specify `var`, then `series` uses the default variable determined by `symvar(f,1)`.

a — Expansion point

0 (default) | number | symbolic number | symbolic variable | symbolic function | symbolic expression

Expansion point, specified as a number, or a symbolic number, variable, function, or expression. The expansion point cannot depend on the expansion variable.

You also can specify the expansion point as a `Name, Value` pair argument. If you specify the expansion point both ways, then the `Name, Value` pair argument takes precedence.

Name-Value Pair Arguments

Specify optional comma-separated pairs of `Name, Value` arguments. `Name` is the argument name and `Value` is the corresponding value. `Name` must appear inside quotes. You can specify several name and value pair arguments in any order as `Name1, Value1, ..., NameN, ValueN`.

Example: `series(psi(x), x, 'ExpansionPoint', Inf, 'Order', 9)`

ExpansionPoint — Expansion point

0 (default) | number | symbolic number | symbolic variable | symbolic function | symbolic expression

Expansion point, specified as a number, or a symbolic number, variable, function, or expression. The expansion point cannot depend on the expansion variable.

You can also specify the expansion point using the input argument `a`. If you specify the expansion point both ways, then the `Name, Value` pair argument takes precedence.

Order — Truncation order of Puiseux series expansion

6 (default) | positive integer | symbolic positive integer

Truncation order of Puiseux series expansion, specified as a positive integer or a symbolic positive integer.

`series` computes the Puiseux series approximation with the order $n - 1$. The truncation order n is the exponent in the O -term: $O(\text{var}^n)$.

Direction — Direction for area of convergence of Puiseux series expansion

'complexPlane' (default) | 'left' | 'right' | 'realAxis'

Direction for area of convergence of Puiseux series expansion, specified as:

'left'	Find a Puiseux series approximation that is valid in a small interval to the left of the expansion point.
'right'	Find a Puiseux series approximation that is valid in a small interval to the right of the expansion point.
'realAxis'	Find a Puiseux series approximation that is valid in a small interval on the both sides of the expansion point.
'complexPlane'	Find a Puiseux series approximation that is valid in a small open circle in the complex plane around the expansion point. This is the default value.

Tips

- If you use both the third argument `a` and the `ExpansionPoint` name-value pair to specify the expansion point, the value specified via `ExpansionPoint` prevails.

See Also

`pade` | `taylor`

Introduced in R2015b

sign

Sign of real or complex value

Syntax

```
sign(z)
```

Description

`sign(z)` returns the sign of real or complex value z . The sign of a complex number z is defined as $z/|z|$. If z is a vector or a matrix, `sign(z)` returns the sign of each element of z .

Examples

Signs of Real Numbers

Find the signs of these symbolic real numbers:

```
[sign(sym(1/2)), sign(sym(0)), sign(sym(pi) - 4)]
```

```
ans =  
[ 1, 0, -1]
```

Signs of Matrix Elements

Find the signs of the real and complex elements of matrix A :

```
A = sym([(1/2 + i), -25; i*(i + 1), pi/6 - i*pi/2]);  
sign(A)
```

```
ans =  
[ 5^(1/2)*(1/5 + 2i/5), -1]  
[ 2^(1/2)*(- 1/2 + 1i/2), 5^(1/2)*18^(1/2)*(1/30 - 1i/10)]
```

Sign of Symbolic Expression

Find the sign of this expression assuming that the value x is negative:

```
syms x  
assume(x < 0)  
sign(5*x^3)
```

```
ans =  
-1
```

For further computations, clear the assumption on x by recreating it using `syms`:

```
syms x
```

Input Arguments

z — Input

symbolic number | symbolic variable | symbolic expression | symbolic function | symbolic vector | symbolic matrix

Input specified as a symbolic number, variable, expression, function, vector, or matrix.

More About

Sign Function

The sign function of any number z is defined via the absolute value of z :

$$\text{sign}(z) = \frac{z}{|z|}$$

Thus, the sign function of a real number z can be defined as follows:

$$\text{sign}(z) = \begin{cases} -1 & \text{if } x < 0 \\ 0 & \text{if } x = 0 \\ 1 & \text{if } x > 0 \end{cases}$$

Tips

- Calling `sign` for a number that is not a symbolic object invokes the MATLAB `sign` function.

See Also

`abs` | `angle` | `imag` | `real` | `signIm`

Introduced in R2013a

signIm

Sign of the imaginary part of complex number

Syntax

`signIm(z)`

Description

`signIm(z)` returns the sign of the imaginary part of a complex number z . For all complex numbers with a nonzero imaginary part, `signIm(z) = sign(imag(z))`. For real numbers, `signIm(z) = -sign(z)`.

$$\text{signIm}(z) = \begin{cases} 1 & \text{if } \text{Im}(z) > 0 \text{ or } \text{Im}(z) = 0 \text{ and } z < 0 \\ 0 & \text{if } z = 0 \\ -1 & \text{otherwise} \end{cases}$$

Examples

Symbolic Results Including signIm

Results of symbolic computations, especially symbolic integration, can include the `signIm` function.

Integrate this expression. For complex values a and x , this integral includes `signIm`.

```
syms a x
f = 1/(a^2 + x^2);
F = int(f, x, -Inf, Inf)
```

```
F =
(pi*signIm(1i/a))/a
```

Signs of Imaginary Parts of Numbers

Find the signs of imaginary parts of complex numbers with nonzero imaginary parts and of real numbers.

Use `signIm` to find the signs of imaginary parts of these numbers. For complex numbers with nonzero imaginary parts, `signIm` returns the sign of the imaginary part of the number.

```
[signIm(-18 + 3*i), signIm(-18 - 3*i),...
signIm(10 + 3*i), signIm(10 - 3*i),...
signIm(Inf*i), signIm(-Inf*i)]
```

```
ans =
     1     -1     1     -1     1     -1
```

For real positive numbers, `signIm` returns `-1`.

```
[signIm(2/3), signIm(1), signIm(100), signIm(Inf)]
```

```
ans =
    -1    -1    -1    -1
```

For real negative numbers, `signIm` returns 1.

```
[signIm(-2/3), signIm(-1), signIm(-100), signIm(-Inf)]
```

```
ans =
     1     1     1     1
```

`signIm(0)` is 0.

```
[signIm(0), signIm(0 + 0*i), signIm(0 - 0*i)]
```

```
ans =
     0     0     0
```

Signs of Imaginary Parts of Symbolic Expressions

Find the signs of imaginary parts of symbolic expressions that represent complex numbers.

Call `signIm` for these symbolic expressions without additional assumptions. Because `signIm` cannot determine if the imaginary part of a symbolic expression is positive, negative, or zero, it returns unresolved symbolic calls.

```
syms x y z
[signIm(z), signIm(x + y*i), signIm(x - 3*i)]
```

```
ans =
 [ signIm(z), signIm(x + y*1i), signIm(x - 3i)]
```

Assume that x , y , and z are positive values. Find the signs of imaginary parts of the same symbolic expressions.

```
syms x y z positive
[signIm(z), signIm(x + y*i), signIm(x - 3*i)]
```

```
ans =
 [ -1, 1, -1]
```

For further computations, clear the assumptions by recreating the variables using `syms`.

```
syms x y z
```

Find the first derivative of the `signIm` function. `signIm` is a constant function, except for the jump discontinuities along the real axis. The `diff` function ignores these discontinuities.

```
syms z
diff(signIm(z), z)
```

```
ans =
 0
```

Signs of Imaginary Parts of Matrix Elements

`signIm` accepts vectors and matrices as its input argument. This lets you find the signs of imaginary parts of several numbers in one function call.

Find the signs of imaginary parts of the real and complex elements of matrix A .

```
A = sym([(1/2 + i), -25; i*(i + 1), pi/6 - i*pi/2]);  
signIm(A)
```

```
ans =  
[ 1,  1]  
[ 1, -1]
```

Input Arguments

z — Input representing complex number

number | symbolic number | symbolic variable | symbolic expression | vector | matrix

Input representing complex number, specified as a number, symbolic number, symbolic variable, expression, vector, or matrix.

Tips

- `signIm(NaN)` returns NaN.

See Also

`conj` | `imag` | `real` | `sign`

Introduced in R2014b

simplify

Algebraic simplification

Syntax

```
S = simplify(expr)
S = simplify(expr,Name,Value)
```

Description

`S = simplify(expr)` performs algebraic simplification of `expr`. If `expr` is a symbolic vector or matrix, this function simplifies each element of `expr`.

`S = simplify(expr,Name,Value)` performs algebraic simplification of `expr` using additional options specified by one or more `Name, Value` pair arguments.

Examples

Simplify Expressions

Simplify these symbolic expressions:

```
syms x a b c
S = simplify(sin(x)^2 + cos(x)^2)
S = simplify(exp(c*log(sqrt(a+b))))
```

```
S =
1
```

```
S =
(a + b)^(c/2)
```

Simplify Matrix Elements

Call `simplify` for this symbolic matrix. When the input argument is a vector or matrix, `simplify` tries to find a simpler form of each element of the vector or matrix.

```
syms x
M = [(x^2 + 5*x + 6)/(x + 2), sin(x)*sin(2*x) + cos(x)*cos(2*x);
      (exp(-x*i)*i)/2 - (exp(x*i)*i)/2, sqrt(16)];
S = simplify(M)
```

```
S =
[ x + 3, cos(x)]
[ sin(x),    4]
```

Get Simpler Results For Logarithms and Powers

Simplify a symbolic expression that contain logarithms and powers. By default, `simplify` does not combine powers and logarithms because combining them is not valid for generic complex values.

```
syms x
expr = (log(x^2 + 2*x + 1) - log(x + 1))*sqrt(x^2);
S = simplify(expr)
```

```
S =
-(log(x + 1) - log((x + 1)^2))*(x^2)^(1/2)
```

To apply the simplification rules that allow the `simplify` function to combine powers and logarithms, set `'IgnoreAnalyticConstraints'` to `true`:

```
S = simplify(expr, 'IgnoreAnalyticConstraints', true)
```

```
S =
x*log(x + 1)
```

Get Simpler Results Using More Simplification Steps

Simplify this expression:

```
syms x
expr = ((exp(-x*i)*i) - (exp(x*i)*i))/(exp(-x*i) + exp(x*i));
S = simplify(expr)
```

```
S =
-(exp(x*2i)*1i - 1i)/(exp(x*2i) + 1)
```

By default, `simplify` uses one internal simplification step. You can get different, often shorter, simplification results by increasing the number of simplification steps:

```
S10 = simplify(expr, 'Steps', 10)
S30 = simplify(expr, 'Steps', 30)
S50 = simplify(expr, 'Steps', 50)
```

```
S10 =
2i/(exp(x*2i) + 1) - 1i
```

```
S30 =
((cos(x) - sin(x)*1i)*1i)/cos(x) - 1i
```

```
S50 =
tan(x)
```

If you are unable to return the desired result, try alternate simplification functions. See “Choose Function to Rearrange Expression” on page 2-104.

Get Equivalent Results For Symbolic Expression

Get equivalent results for a symbolic expression by setting the value of `'All'` to `true`.

```
syms x
expr = cos(x)^2 - sin(x)^2;
S = simplify(expr, 'All', true)
```

```
S =
      cos(2*x)
cos(x)^2 - sin(x)^2
```

Increase the number of simplification steps to 10. Find the other equivalent results for the same expression.

```
S = simplify(expr, 'Steps', 10, 'All', true)
```

```
S =
      cos(2*x)
    1 - 2*sin(x)^2
    2*cos(x)^2 - 1
  cos(x)^2 - sin(x)^2
    cot(2*x)*sin(2*x)
  exp(-x*2i)/2 + exp(x*2i)/2
```

Separate Real and Imaginary Parts

Attempt to separate real and imaginary parts of an expression by setting the value of 'Criterion' to 'preferReal'.

```
syms x
f = (exp(x + exp(-x*i)/2 - exp(x*i)/2)*i)/2 - ...
    (exp(-x - exp(-x*i)/2 + exp(x*i)/2)*i)/2;
S = simplify(f, 'Criterion', 'preferReal', 'Steps', 100)
```

```
S =
sin(sin(x))*cosh(x) + cos(sin(x))*sinh(x)*1i
```

If 'Criterion' is not set to 'preferReal', then `simplify` returns a shorter result but the real and imaginary parts are not separated.

```
S = simplify(f, 'Steps', 100)
```

```
S =
sin(sin(x) + x*1i)
```

When you set 'Criterion' to 'preferReal', the simplifier disfavors expression forms where complex values appear inside subexpressions. In nested subexpressions, the deeper the complex value appears inside an expression, the least preference this form of an expression gets.

Avoid Imaginary Terms in Exponents

Attempt to avoid imaginary terms in exponents by setting 'Criterion' to 'preferReal'.

Show this behavior by simplifying a complex symbolic expression with and without setting 'Criterion' to 'preferReal'. When 'Criterion' is set to 'preferReal', then `simplify` places the imaginary term outside the exponent.

```
expr = sym(i)^(i+1);
withoutPreferReal = simplify(expr, 'Steps', 100)
```

```
withoutPreferReal =
(-1)^(1/2 + 1i/2)
```

```
withPreferReal = simplify(expr, 'Criterion', 'preferReal', 'Steps', 100)
```

```
withPreferReal =
exp(-pi/2)*1i
```

Simplify Units

Simplify expressions containing symbolic units of the same dimension by using `simplify`.

```
u = symunit;
expr = 300*u.cm + 40*u.inch + 2*u.m;
S = simplify(expr)
```

```
S =
(3008/5)*[cm]
```

`simplify` automatically chooses the unit to rewrite into. To choose a specific unit, use `rewrite`.

Input Arguments

expr — Input expression

symbolic expression | symbolic function | symbolic vector | symbolic matrix

Input expression, specified as a symbolic expression, function, vector, or matrix.

Name-Value Pair Arguments

Specify optional comma-separated pairs of **Name**, **Value** arguments. **Name** is the argument name and **Value** is the corresponding value. **Name** must appear inside quotes. You can specify several name and value pair arguments in any order as `Name1, Value1, ..., NameN, ValueN`.

Example: `'Seconds', 60` limits the simplification process to 60 seconds.

All — Option to return equivalent results

false (default) | true

Option to return equivalent results, specified as the comma-separated pair consisting of `'All'` and either of the two logical values. When you use this option, the input argument `expr` must be a scalar.

false	Use the default option to return only the final simplification result.
true	Return a column vector of equivalent results for the input expression. You can use this option along with the <code>'Steps'</code> option to obtain alternative expressions in the simplification process.

Criterion — Simplification criterion

'default' (default) | 'preferReal'

Simplification criterion, specified as the comma-separated pair consisting of `'Criterion'` and one of these character vectors.

'default'	Use the default (internal) simplification criteria.
'preferReal'	Favor the forms of <code>S</code> containing real values over the forms containing complex values. If any form of <code>S</code> contains complex values, the simplifier disfavors the forms where complex values appear inside subexpressions. In case of nested subexpressions, the deeper the complex value appears inside an expression, the least preference this form of an expression gets.

IgnoreAnalyticConstraints — Simplification rules

false (default) | true

Simplification rules, specified as the comma-separated pair consisting of `'IgnoreAnalyticConstraints'` and one of these values.

<code>false</code>	Use strict simplification rules. <code>simplify</code> always returns results that are analytically equivalent to the initial expression.
<code>true</code>	Apply purely algebraic simplifications to an expression. <code>simplify</code> can return simpler results for the input expressions where it would return more complicated results otherwise. Setting <code>IgnoreAnalyticConstraints</code> to <code>true</code> can lead to results that are not equivalent to the initial expression.

Seconds — Time limit for the simplification process

`Inf (default) | positive number`

Time limit for the simplification process, specified as the comma-separated pair consisting of 'Seconds' and a positive value that denotes the maximal time in seconds.

Steps — Number of simplification steps

`1 (default) | positive number`

Number of simplification steps, specified as the comma-separated pair consisting of 'Steps' and a positive value that denotes the maximal number of internal simplification steps. Note that increasing the number of simplification steps can slow down your computations.

`simplify(expr, 'Steps', n)` is equivalent to `simplify(expr, n)`, where `n` is the number of simplification steps.

Tips

- Simplification of mathematical expression is not a clearly defined subject. There is no universal idea as to which form of an expression is simplest. The form of a mathematical expression that is simplest for one problem might be complicated or even unsuitable for another problem.

Algorithms

When you use `IgnoreAnalyticConstraints`, then `simplify` follows these rules:

- $\log(a) + \log(b) = \log(a \cdot b)$ for all values of a and b . In particular, the following equality is valid for all values of a , b , and c :

$$(a \cdot b)^c = a^c \cdot b^c.$$

- $\log(a^b) = b \cdot \log(a)$ for all values of a and b . In particular, the following equality is valid for all values of a , b , and c :

$$(a^b)^c = a^{b \cdot c}.$$

- If f and g are standard mathematical functions and $f(g(x)) = x$ for all small positive numbers, $f(g(x)) = x$ is assumed to be valid for all complex values of x . In particular:

- $\log(e^x) = x$
- $\text{asin}(\sin(x)) = x$, $\text{acos}(\cos(x)) = x$, $\text{atan}(\tan(x)) = x$
- $\text{asinh}(\sinh(x)) = x$, $\text{acosh}(\cosh(x)) = x$, $\text{atanh}(\tanh(x)) = x$
- $W_k(x \cdot e^x) = x$ for all branch indices k of the Lambert W function.

See Also

Functions

collect | combine | expand | factor | horner | numden | rewrite | simplifyFraction

Live Editor Tasks

Simplify Symbolic Expression

Topics

“Simplify Symbolic Expressions” on page 2-81

“Choose Function to Rearrange Expression” on page 2-104

“Simplify Symbolic Expressions Using Live Editor Task” on page 2-94

Introduced before R2006a

simplifyFraction

Simplify symbolic rational expressions

Syntax

```
simplifyFraction(expr)
simplifyFraction(expr, 'Expand', true)
```

Description

`simplifyFraction(expr)` simplifies the rational expression `expr` such that the numerator and denominator have no divisors in common.

`simplifyFraction(expr, 'Expand', true)` expands the numerator and denominator of the resulting simplified fraction as polynomials without factorization.

Examples

Simplify Symbolic Rational Expressions

Simplify two rational expressions by using `simplifyFraction`.

```
syms x y
fraction = (x^2-1)/(x+1);
simplifyFraction(fraction)

ans =
x - 1

fraction = (y*(x^2-1))/((x+1)*(x-1));
simplifyFraction(fraction)

ans =
y
```

Expand Simplified Rational Expression

Create a rational expression. Simplify the expression by using `simplifyFraction`.

```
syms x y
fraction = ((y+1)^2*(x^2-1))/((x+1)*(x-1)^2);
simplifyFraction(fraction)

ans =
(y + 1)^2/(x - 1)
```

Simplify the same rational expression again. Expand the numerator and denominator of the resulting fraction by setting `'Expand'` to `true`.

```
simplifyFraction(fraction, 'Expand', true)
```

```
ans =  
(y^2 + 2*y + 1)/(x - 1)
```

Simplify Rational Subexpressions of Expressions

Simplify rational expressions by using `simplifyFraction`.

```
syms x  
expr = ((x^2+2*x+1)/(x+1))^(1/2);  
simplifyFraction(expr)
```

```
ans =  
(x + 1)^(1/2)
```

Simplify rational expressions that contain irrational subexpressions instead of variables.

```
expr = (1-sin(x)^2)/(1-sin(x));  
simplifyFraction(expr)
```

```
ans =  
sin(x) + 1
```

`simplifyFraction` does not apply algebraic identities to simplify the rational expression. Show that `simplifyFraction` does not apply standard trigonometric identities.

```
expr = (1-cos(x)^2)/sin(x);  
simplifyFraction(expr)
```

```
ans =  
-(cos(x)^2 - 1)/sin(x)
```

Input Arguments

expr — Input

number | vector | matrix | array | symbolic number | symbolic variable | symbolic array | symbolic function | symbolic expression

Input, specified as a number, vector, matrix, or array, or a symbolic number, variable, array, function, or expression.

Tips

- `expr` can contain irrational subexpressions, such as $\sin(x)$ and $x^{(-1/3)}$. `simplifyFraction` simplifies such expressions as if they were variables.
- `simplifyFraction` does not apply algebraic identities.

Alternatives

You can also simplify rational expressions using the general simplification function `simplify`. However, `simplifyFraction` is more efficient for simplifying rational expressions.

See Also

Functions

collect | combine | expand | factor | horner | numden | rewrite | simplify

Live Editor Tasks

Simplify Symbolic Expression

Topics

“Simplify Symbolic Expressions” on page 2-81

“Choose Function to Rearrange Expression” on page 2-104

“Simplify Symbolic Expressions Using Live Editor Task” on page 2-94

Introduced in R2011b

Simplify Symbolic Expression

Simplify symbolic expressions in Live Editor

Description

The **Simplify Symbolic Expression** task enables you to interactively simplify or rearrange symbolic expressions. The task automatically generates MATLAB code for your live script. For more information about Live Editor tasks, see “Add Interactive Tasks to a Live Script” (MATLAB).

Using this task, you can:

- Perform algebraic simplification of symbolic expressions.
- Rewrite expressions in terms of another function.
- Expand algebraic expressions.
- Combine terms of identical algebraic structure.
- Generate the code used to simplify or rearrange expressions.

Related Functions

The code that **Simplify Symbolic Expression** generates to simplify expressions uses these functions.

- `simplify`
- `simplifyFraction`
- `rewrite`
- `expand`
- `combine`

Description (collapsed portion)

Related Functions

The code that **Simplify Symbolic Expression** generates to simplify expressions uses these functions.

- `simplify`
- `simplifyFraction`
- `rewrite`
- `expand`
- `combine`

Open the Task

To add the **Simplify Symbolic Expression** task to a live script in the MATLAB Editor:

- On the **Live Editor** tab, select **Task > Simplify Symbolic Expression**.
- In a code block in your script, type a relevant keyword, such as `simplify`, `symbolic`, `rewrite`, `expand`, or `combine`. Select Simplify Symbolic Expression from the suggested command completions.

Parameters

Method — Specify simplification method

`Simplify` (default) | `Simplify fraction` | `Rewrite` | `Expand` | `Combine`

Specify the simplification method from the drop-down list:

Simplification Method	Description
<code>Simplify</code>	Perform algebraic simplification.
<code>Simplify fraction</code>	Simplify symbolic rational expressions.
<code>Rewrite</code>	Rewrite expressions in terms of another function.
<code>Expand</code>	Expand expressions and simplify inputs of functions by using identities.
<code>Combine</code>	Combine terms of identical algebraic structure.

Effort — Specify computational effort used to simplify

`Minimum` (default) | `Low` | `Medium` | `High` | `Full`

Specify the computational effort used for the `Simplify` method from the drop-down list:

Simplification Effort	Description
<code>Minimum</code>	Minimum effort with fastest computation time (can return most complicated result)
<code>Low</code>	Low effort with faster computation time
<code>Medium</code>	Medium effort with normal computation time
<code>High</code>	High effort with slower computation time
<code>Full</code>	Full effort with slowest computation time (can return simplest result)

Multiply out brackets — Multiply out brackets when expanding expressions

`off` (default) | `on`

Select this check box to not expand special functions for the `Expand` method. This option expands the arithmetic part of an expression, such as powers and roots, without expanding trigonometric, hyperbolic, logarithmic, and special functions.

Ignore analytic constraints — Ignore analytic constraints when expanding expressions

`off` (default) | `on`

Select this check box to apply purely algebraic simplifications to give simpler solutions for the `Expand` method, which could lead to results not generally valid. This option applies mathematical identities that are convenient, but do not always hold for all values of variables. In some cases, this option can lead to simpler results that are not equivalent to the initial expression.

See Also

Functions

combine | expand | rewrite | simplify | simplifyFraction

Live Editor Tasks

Solve Symbolic Equation

Topics

“Add Interactive Tasks to a Live Script” (MATLAB)

“Simplify Symbolic Expressions Using Live Editor Task” on page 2-94

“Choose Function to Rearrange Expression” on page 2-104

“Simplify Symbolic Expressions” on page 2-81

Introduced in R2020a

simscapeEquation

Convert symbolic expressions to Simscape language equations

Syntax

```
simscapeEquation(f)
simscapeEquation(LHS,RHS)
```

Description

`simscapeEquation(f)` converts the symbolic expression f to a Simscape language equation. This function call converts any derivative with respect to the variable t to the Simscape notation $X.der$. Here X is the time-dependent variable. In the resulting Simscape equation, the variable *time* replaces all instances of the variable t except for derivatives with respect to t .

`simscapeEquation` converts expressions with the second and higher-order derivatives to a system of first-order equations, introducing new variables, such as $x1$, $x2$, and so on.

`simscapeEquation(LHS,RHS)` returns a Simscape equation $LHS == RHS$.

Examples

Convert Expressions to Simscape Equations

Convert the following expressions to Simscape language equations.

```
syms t x(t) y(t)
phi = diff(x) + 5*y + sin(t);
simscapeEquation(phi)
simscapeEquation(diff(y),phi)

ans =
    'phi == sin(time)+y*5.0+x.der;'

ans =
    'y.der == sin(time)+y*5.0+x.der;'
```

Convert ODE to Simscape Equation

Convert this expression containing the second derivative.

```
syms x(t)
eqn1 = diff(x,2) - diff(x) + sin(t);
simscapeEquation(eqn1)

ans =
    'x.der == x1;
    eqn1 == sin(time)-x1+x1.der;'
```

Convert this expression containing the fourth and second derivatives.

```
eqn2 = diff(x,4) + diff(x,2) - diff(x) + sin(t);  
simscapeEquation(eqn2)
```

```
ans =  
    'x.der == x1;  
    x1.der == x2;  
    x2.der == x3;  
    eqn2 == sin(time)-x1+x2+x3.der;'
```

Tips

- The equation section of a Simscape component file supports a limited number of functions. For details and the list of supported functions, see Simscape [equations](#). If a symbolic equation contains functions that are not available in the equation section of a Simscape component file, `simscapeEquation` cannot convert these equations correctly to Simscape equations. Such expressions do not trigger an error message. Expressions with infinities are prone to invalid conversion.

See Also

[ccode](#) | [fortran](#) | [matlabFunction](#) | [matlabFunctionBlock](#) | [symWriteSSC](#)

Topics

“Generate Simscape Equations from Symbolic Expressions” on page 2-272

Introduced in R2010a

sin

Symbolic sine function

Syntax

`sin(X)`

Description

`sin(X)` returns the sine function on page 4-1225 of X.

Examples

Sine Function for Numeric and Symbolic Arguments

Depending on its arguments, `sin` returns floating-point or exact symbolic results.

Compute the sine function for these numbers. Because these numbers are not symbolic objects, `sin` returns floating-point results.

```
A = sin([-2, -pi, pi/6, 5*pi/7, 11])
```

```
A =
   -0.9093   -0.0000    0.5000    0.7818   -1.0000
```

Compute the sine function for the numbers converted to symbolic objects. For many symbolic (exact) numbers, `sin` returns unresolved symbolic calls.

```
symA = sin(sym([-2, -pi, pi/6, 5*pi/7, 11]))
```

```
symA =
[ -sin(2), 0, 1/2, sin((2*pi)/7), sin(11)]
```

Use `vpa` to approximate symbolic results with floating-point numbers:

```
vpa(symA)
```

```
ans =
[ -0.90929742682568169539601986591174,...
  0,...
  0.5,...
  0.78183148246802980870844452667406,...
 -0.99999020655070345705156489902552]
```

Plot Sine Function

Plot the sine function on the interval from -4π to 4π .

```
syms x
fplot(sin(x),[-4*pi 4*pi])
grid on
```

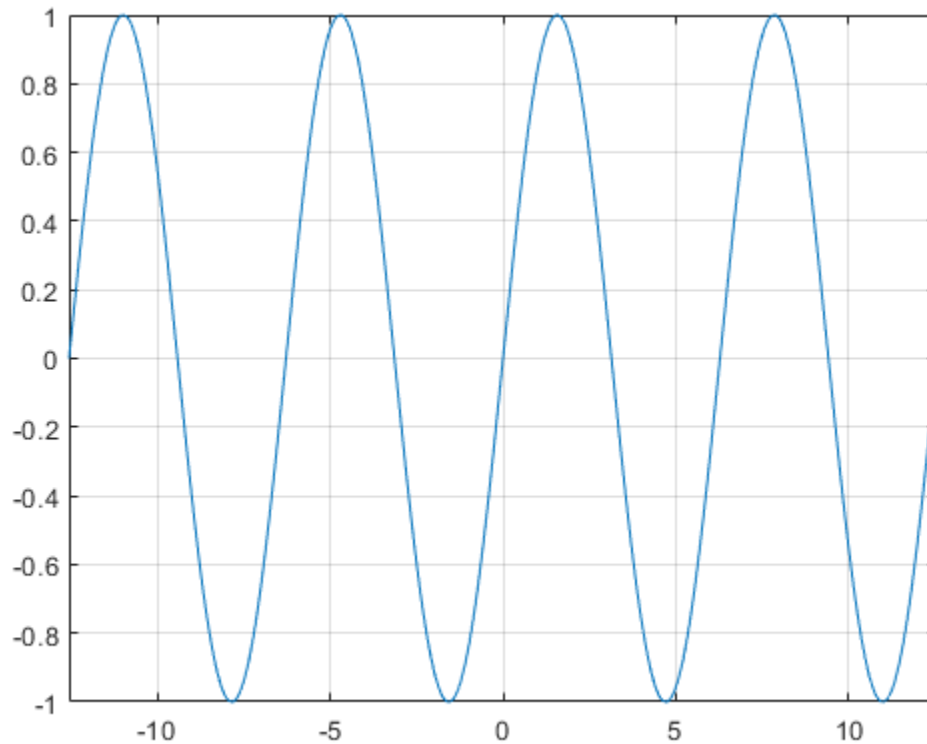

Handle Expressions Containing Sine Function

Many functions, such as `diff`, `int`, `taylor`, and `rewrite`, can handle expressions containing `sin`.

Find the first and second derivatives of the sine function:

```
syms x
diff(sin(x), x)
diff(sin(x), x, x)
```

```
ans =
cos(x)
```

```
ans =
-sin(x)
```

Find the indefinite integral of the sine function:

```
int(sin(x), x)
```

```
ans =
-cos(x)
```

Find the Taylor series expansion of `sin(x)`:

```
taylor(sin(x), x)
```

```
ans =
x^5/120 - x^3/6 + x
```

Rewrite the sine function in terms of the exponential function:

```
rewrite(sin(x), 'exp')

ans =
(exp(-x*1i)*1i)/2 - (exp(x*1i)*1i)/2
```

Evaluate Units with sin Function

sin numerically evaluates these units automatically: radian, degree, arcmin, arcsec, and revolution.

Show this behavior by finding the sine of x degrees and 2 radians.

```
u = symunit;
syms x
f = [x*u.degree 2*u.radian];
sinf = sin(f)

sinf =
[ sin((pi*x)/180), sin(2)]
```

You can calculate `sinf` by substituting for `x` using `subs` and then using `double` or `vpa`.

Input Arguments

X — Input

symbolic number | symbolic variable | symbolic expression | symbolic function | symbolic vector | symbolic matrix

Input, specified as a symbolic number, variable, expression, or function, or as a vector or matrix of symbolic numbers, variables, expressions, or functions.

More About

Sine Function

The sine of an angle, α , defined with reference to a right angled triangle is

$$\sin(\alpha) = \frac{\text{opposite side}}{\text{hypotenuse}} = \frac{a}{h} .$$

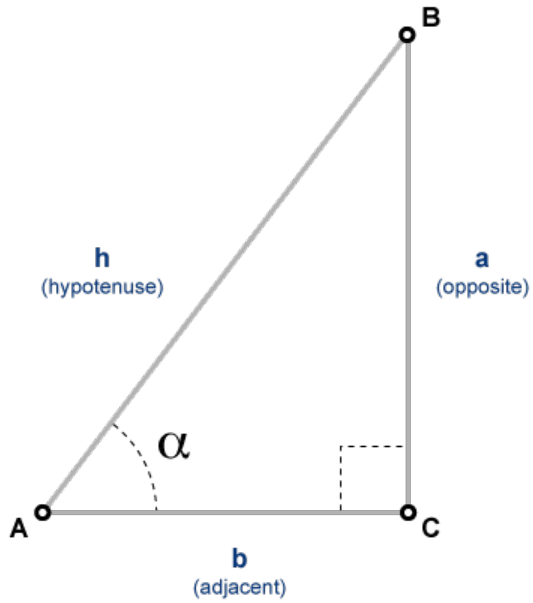

The sine of a complex argument, α , is

$$\sin(\alpha) = \frac{e^{i\alpha} - e^{-i\alpha}}{2i} .$$

See Also

acos | acot | acsc | asec | asin | atan | cos | cot | csc | sec | sinc | tan

Introduced before R2006a

sinc

Normalized sinc function

Syntax

```
sinc(x)
```

Description

`sinc(x)` returns $\sin(\pi x)/(\pi x)$. The symbolic `sinc` function does not implement floating-point results, only symbolic results. Floating-point results are returned by the `sinc` function in Signal Processing Toolbox™.

Examples

Sinc Function of Symbolic Inputs

```
syms x
sinc(x)

ans =
sin(pi*x)/(x*pi)
```

Show that `sinc` returns 1 at 0, 0 at other integer inputs, and exact symbolic values for other inputs.

```
V = sym([-1 0 1 3/2]);
S = sinc(V)
```

```
S =
[ 0, 1, 0, -2/(3*pi)]
```

Convert the exact symbolic output to high-precision floating point by using `vpa`.

```
vpa(S)

ans =
[ 0, 1.0, 0, -0.21220659078919378102517835116335]
```

Fourier Transforms Involving Sinc Function

Although `sinc` appears in tables of Fourier transforms, `fourier` does not return `sinc` in output.

Show that `fourier` transforms a pulse in terms of `sin` and `cos`.

```
fourier(rectangularPulse(x))

ans =
(cos(w/2)*1i + sin(w/2))/w - (cos(w/2)*1i - sin(w/2))/w
```

Show that `fourier` transforms `sinc` in terms of `heaviside`.

```
syms x
fourier(sinc(x))

ans =
(pi*heaviside(pi - w) - pi*heaviside(- w - pi))/pi
```

Plot Sinc Function

Plot the sinc function by using `fplot`.

```
syms x
fplot(sinc(x))
```

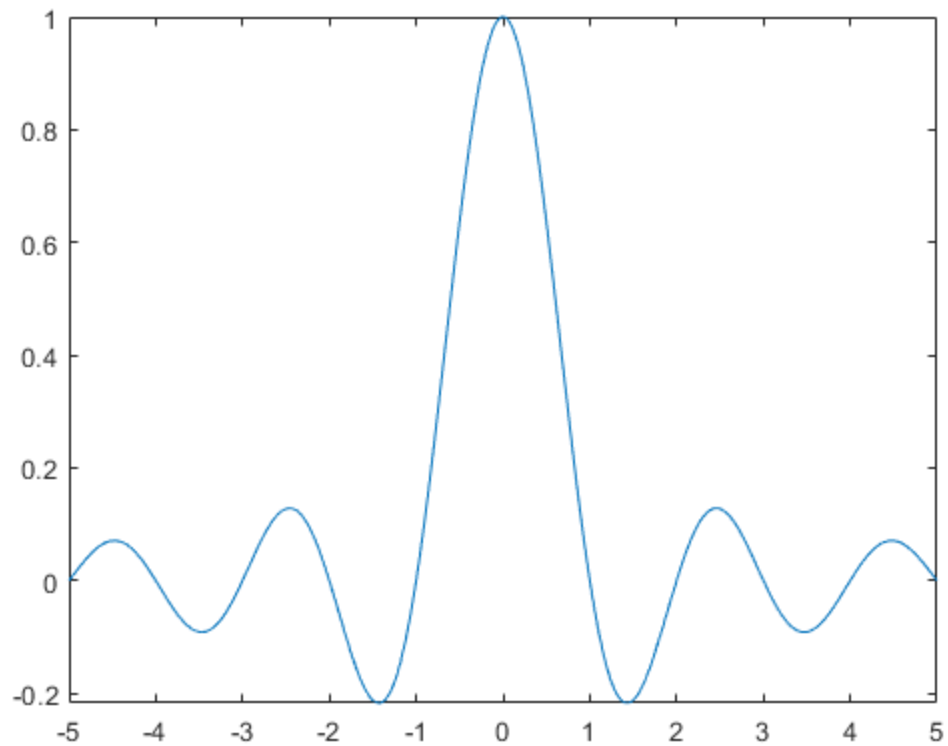

Rewrite Sinc Function to Other Functions

Rewrite the sinc function to the exponential function `exp` by using `rewrite`.

```
syms x
rewrite(sinc(x), 'exp')

ans =
((exp(-pi*x*1i)*1i)/2 - (exp(pi*x*1i)*1i)/2)/(x*pi)
```

Differentiate, Integrate, and Expand the Sinc Function

Differentiate, integrate, and expand sinc by using the `diff`, `int`, and `taylor` functions, respectively.

Differentiate sinc.

```
syms x
diff(sinc(x))

ans =
cos(pi*x)/x - sin(pi*x)/(x^2*pi)
```

Integrate sinc from `-Inf` to `Inf`.

```
int(sinc(x), [-Inf Inf])

ans =
1
```

Integrate sinc from `-Inf` to `x`.

```
int(sinc(x), -Inf, x)

ans =
sinint(pi*x)/pi + 1/2
```

Find the Taylor expansion of sinc.

```
taylor(sinc(x))

ans =
(pi^4*x^4)/120 - (pi^2*x^2)/6 + 1
```

Prove Identity Involving Sinc Function

Prove an identity by defining the identity as a condition and using the `isAlways` function to check the condition.

Prove this identity.

$$\text{sinc}(x) = \frac{1}{\Gamma(1+x)\Gamma(1-x)}.$$

```
syms x
cond = sinc(x) == 1/(gamma(1+x)*gamma(1-x));
isAlways(cond)
```

```
ans =  
    logical  
     1
```

Input Arguments

x — Input

number | vector | matrix | array | symbolic number | symbolic variable | symbolic array | symbolic function | symbolic expression

Input, specified as a number, vector, matrix, or array, or a symbolic number, variable, array, function, or expression.

See Also

sin

Introduced in R2018b

sinh

Symbolic hyperbolic sine function

Syntax

```
sinh(X)
```

Description

`sinh(X)` returns the hyperbolic sine function of X .

Examples

Hyperbolic Sine Function for Numeric and Symbolic Arguments

Depending on its arguments, `sinh` returns floating-point or exact symbolic results.

Compute the hyperbolic sine function for these numbers. Because these numbers are not symbolic objects, `sinh` returns floating-point results.

```
A = sinh([-2, -pi*i, pi*i/6, 5*pi*i/7, 3*pi*i/2])
A =
-3.6269 + 0.0000i    0.0000 - 0.0000i    0.0000 + 0.5000i...
 0.0000 + 0.7818i    0.0000 - 1.0000i
```

Compute the hyperbolic sine function for the numbers converted to symbolic objects. For many symbolic (exact) numbers, `sinh` returns unresolved symbolic calls.

```
symA = sinh(sym([-2, -pi*i, pi*i/6, 5*pi*i/7, 3*pi*i/2]))
symA =
[ -sinh(2), 0, 1i/2, sinh((pi*2i)/7), -1i]
```

Use `vpa` to approximate symbolic results with floating-point numbers:

```
vpa(symA)
ans =
[ -3.6268604078470187676682139828013,...
 0,...
 0.5i,...
 0.78183148246802980870844452667406i,...
 -1.0i]
```

Plot Hyperbolic Sine Function

Plot the hyperbolic sine function on the interval from $-\pi$ to π .

```
syms x
fplot(sinh(x),[-pi pi])
grid on
```

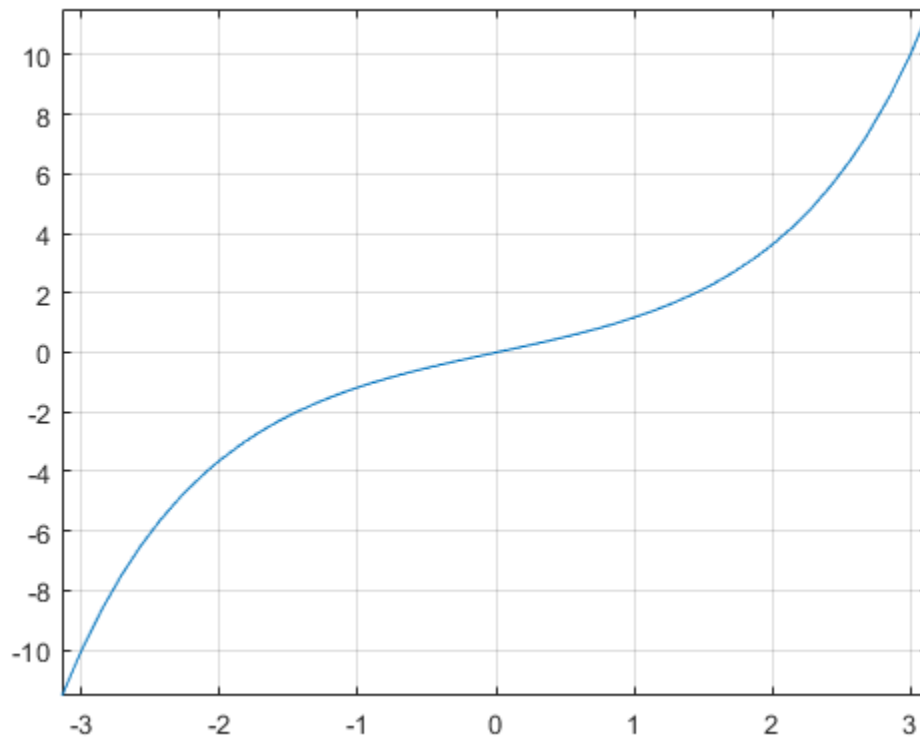

Handle Expressions Containing Hyperbolic Sine Function

Many functions, such as `diff`, `int`, `taylor`, and `rewrite`, can handle expressions containing `sinh`.

Find the first and second derivatives of the hyperbolic sine function:

```
syms x
diff(sinh(x), x)
diff(sinh(x), x, x)
```

```
ans =
cosh(x)
```

```
ans =
sinh(x)
```

Find the indefinite integral of the hyperbolic sine function:

```
int(sinh(x), x)
```

```
ans =
cosh(x)
```

Find the Taylor series expansion of `sinh(x)`:

```
taylor(sinh(x), x)
```

```
ans =  
x^5/120 + x^3/6 + x
```

Rewrite the hyperbolic sine function in terms of the exponential function:

```
rewrite(sinh(x), 'exp')
```

```
ans =  
exp(x)/2 - exp(-x)/2
```

Input Arguments

X — Input

symbolic number | symbolic variable | symbolic expression | symbolic function | symbolic vector | symbolic matrix

Input, specified as a symbolic number, variable, expression, or function, or as a vector or matrix of symbolic numbers, variables, expressions, or functions.

See Also

acosh | acoth | acsch | asech | asinh | atanh | cosh | coth | csch | sech | tanh

Introduced before R2006a

sinhint

Hyperbolic sine integral function

Syntax

```
sinhint(X)
```

Description

`sinhint(X)` returns the hyperbolic sine integral function on page 4-1236 of X.

Examples

Hyperbolic Sine Integral Function for Numeric and Symbolic Arguments

Depending on its arguments, `sinhint` returns floating-point or exact symbolic results.

Compute the hyperbolic sine integral function for these numbers. Because these numbers are not symbolic objects, `sinhint` returns floating-point results.

```
A = sinhint([-pi, -1, 0, pi/2, 2*pi])
```

```
A =
    -5.4696    -1.0573         0     1.8027    53.7368
```

Compute the hyperbolic sine integral function for the numbers converted to symbolic objects. For many symbolic (exact) numbers, `sinhint` returns unresolved symbolic calls.

```
symA = sinhint(sym([-pi, -1, 0, pi/2, 2*pi]))
```

```
symA =
[ -sinhint(pi), -sinhint(1), 0, sinhint(pi/2), sinhint(2*pi)]
```

Use `vpa` to approximate symbolic results with floating-point numbers:

```
vpa(symA)
```

```
ans =
[ -5.4696403451153421506369580091277,...
 -1.0572508753757285145718423548959,...
 0,...
 1.802743198288293882089794577617,...
 53.736750620859153990408011863262]
```

Plot Hyperbolic Sine Integral Function

Plot the hyperbolic sine integral function on the interval from -2π to 2π .

```
syms x
fplot(sinhint(x),[-2*pi 2*pi])
grid on
```

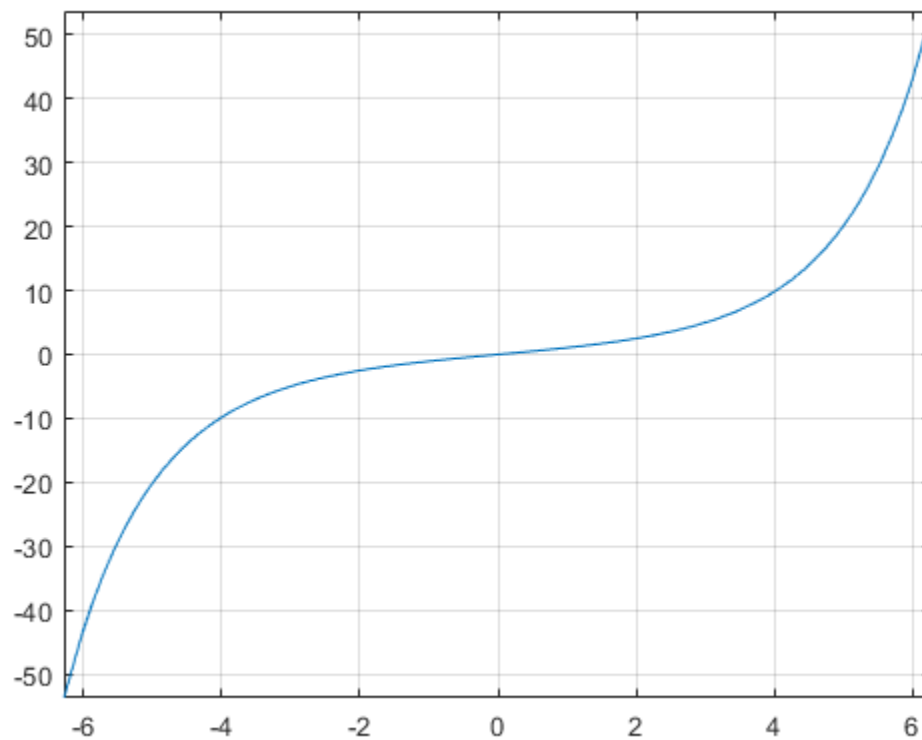
Handle Expressions Containing Hyperbolic Sine Integral Function

Many functions, such as `diff`, `int`, and `taylor`, can handle expressions containing `sinhint`.

Find the first and second derivatives of the hyperbolic sine integral function:

```
syms x
diff(sinhint(x), x)
diff(sinhint(x), x, x)
```

```
ans =
sinh(x)/x
```

```
ans =
cosh(x)/x - sinh(x)/x^2
```

Find the indefinite integral of the hyperbolic sine integral function:

```
int(sinhint(x), x)
```

```
ans =
x*sinhint(x) - cosh(x)
```

Find the Taylor series expansion of `sinhint(x)`:

```
taylor(sinhint(x), x)
```

```
ans =  
x^5/600 + x^3/18 + x
```

Input Arguments

X — Input

symbolic number | symbolic variable | symbolic expression | symbolic function | symbolic vector | symbolic matrix

Input, specified as a symbolic number, variable, expression, or function, or as a vector or matrix of symbolic numbers, variables, expressions, or functions.

More About

Hyperbolic Sine Integral Function

The hyperbolic sine integral function is defined as follows:

$$\text{Shi}(x) = \int_0^x \frac{\sinh(t)}{t} dt$$

References

- [1] Gautschi, W. and W. F. Cahill. “Exponential Integral and Related Functions.” *Handbook of Mathematical Functions with Formulas, Graphs, and Mathematical Tables*. (M. Abramowitz and I. A. Stegun, eds.). New York: Dover, 1972.

See Also

coshint | cosint | eulergamma | int | sin | sinint | ssinint

Introduced in R2014a

sinint

Sine integral function

Syntax

```
sinint(X)
```

Description

`sinint(X)` returns the sine integral function of X .

Examples

Sine Integral Function for Numeric and Symbolic Arguments

Depending on its arguments, `sinint` returns floating-point or exact symbolic results.

Compute the sine integral function for these numbers. Because these numbers are not symbolic objects, `sinint` returns floating-point results.

```
A = sinint([- pi, 0, pi/2, pi, 1])
```

```
A =
   -1.8519         0    1.3708    1.8519    0.9461
```

Compute the sine integral function for the numbers converted to symbolic objects. For many symbolic (exact) numbers, `sinint` returns unresolved symbolic calls.

```
symA = sinint(sym([- pi, 0, pi/2, pi, 1]))
```

```
symA =
[ -sinint(pi), 0, sinint(pi/2), sinint(pi), sinint(1)]
```

Use `vpa` to approximate symbolic results with floating-point numbers:

```
vpa(symA)
```

```
ans =
[ -1.851937051982466170361053370158,...
  0,...
  1.3707621681544884800696782883816,...
  1.851937051982466170361053370158,...
  0.94608307036718301494135331382318]
```

Plot Sine Integral Function

Plot the sine integral function on the interval from -4π to 4π .

```
syms x
fplot(sinint(x),[-4*pi 4*pi])
grid on
```

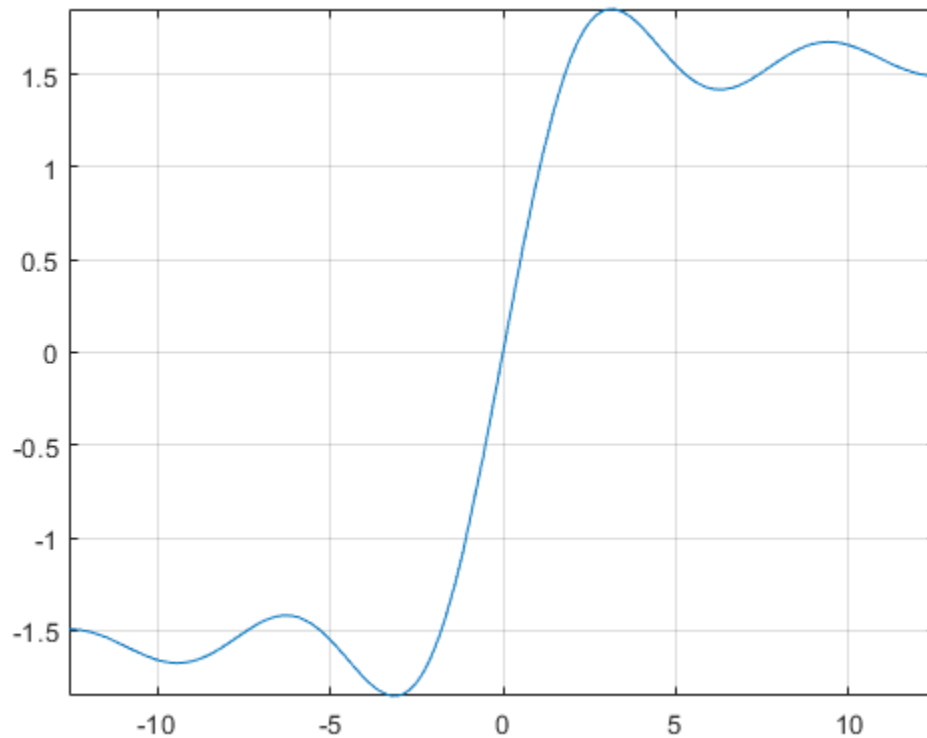

Handle Expressions Containing Sine Integral Function

Many functions, such as `diff`, `int`, and `taylor`, can handle expressions containing `sinint`.

Find the first and second derivatives of the sine integral function:

```
syms x
diff(sinint(x), x)
diff(sinint(x), x, x)
```

```
ans =
sin(x)/x
```

```
ans =
cos(x)/x - sin(x)/x^2
```

Find the indefinite integral of the sine integral function:

```
int(sinint(x), x)
```

```
ans =
cos(x) + x*sinint(x)
```

Find the Taylor series expansion of `sinint(x)`:

```
taylor(sinint(x), x)
```

ans =
 $x^5/600 - x^3/18 + x$

Input Arguments

X — Input

symbolic number | symbolic variable | symbolic expression | symbolic function | symbolic vector | symbolic matrix

Input, specified as a symbolic number, variable, expression, or function, or as a vector or matrix of symbolic numbers, variables, expressions, or functions.

More About

Sine Integral Function

The sine integral function is defined as follows:

$$\text{Si}(x) = \int_0^x \frac{\sin(t)}{t} dt$$

References

- [1] Gautschi, W. and W. F. Cahill. "Exponential Integral and Related Functions." *Handbook of Mathematical Functions with Formulas, Graphs, and Mathematical Tables*. (M. Abramowitz and I. A. Stegun, eds.). New York: Dover, 1972.

See Also

coshint | cosint | eulergamma | int | sin | sinhint | ssinint

Introduced before R2006a

smithForm

Smith form of matrix

Syntax

```
S = smithForm(A)
[U,V,S] = smithForm(A)

___ = smithForm(A,var)
```

Description

`S = smithForm(A)` returns the Smith normal form on page 4-1244 of a square invertible matrix `A`. The elements of `A` must be integers or polynomials in a variable determined by `symvar(A,1)`. The Smith form `S` is a diagonal matrix.

`[U,V,S] = smithForm(A)` returns the Smith normal form of `A` and unimodular transformation matrices `U` and `V`, such that $S = U*A*V$.

`___ = smithForm(A,var)` assumes that the elements of `A` are univariate polynomials in the specified variable `var`. If `A` contains other variables, `smithForm` treats those variables as symbolic parameters.

You can use the input argument `var` in any of the previous syntaxes.

If `A` does not contain `var`, then `smithForm(A)` and `smithForm(A,var)` return different results.

Examples

Smith Form for Matrix of Integers

Find the Smith form of an inverse Hilbert matrix.

```
A = sym(invhilb(5))
S = smithForm(A)
```

```
A =
[ 25, -300, 1050, -1400, 630]
[ -300, 4800, -18900, 26880, -12600]
[ 1050, -18900, 79380, -117600, 56700]
[ -1400, 26880, -117600, 179200, -88200]
[ 630, -12600, 56700, -88200, 44100]
```

```
S =
[ 5, 0, 0, 0, 0]
[ 0, 60, 0, 0, 0]
[ 0, 0, 420, 0, 0]
[ 0, 0, 0, 840, 0]
[ 0, 0, 0, 0, 2520]
```

Smith Form for Matrix of Univariate Polynomials

Create a 2-by-2 matrix, the elements of which are polynomials in the variable x .

```
syms x
A = [x^2 + 3, (2*x - 1)^2; (x + 2)^2, 3*x^2 + 5]

A =
[ x^2 + 3, (2*x - 1)^2]
[ (x + 2)^2, 3*x^2 + 5]
```

Find the Smith form of this matrix.

```
S = smithForm(A)

S =
[ 1, 0]
[ 0, x^4 + 12*x^3 - 13*x^2 - 12*x - 11]
```

Smith Form for Matrix of Multivariate Polynomials

Create a 2-by-2 matrix containing two variables: x and y .

```
syms x y
A = [2/x + y, x^2 - y^2; 3*sin(x) + y, x]

A =
[ y + 2/x, x^2 - y^2]
[ y + 3*sin(x), x]
```

Find the Smith form of this matrix. If you do not specify the polynomial variable, `smithForm` uses `symvar(A,1)` and thus determines that the polynomial variable is x . Because $3*\sin(x) + y$ is not a polynomial in x , `smithForm` throws an error.

```
S = smithForm(A)
```

```
Error using mupadengine/feval (line 163)
Cannot convert the matrix entries to integers or univariate polynomials.
```

Find the Smith form of A specifying that all elements of A are polynomials in the variable y .

```
S = smithForm(A,y)

S =
[ 1, 0]
[ 0, 3*y^2*sin(x) - 3*x^2*sin(x) + y^3 + y*(- x^2 + x) + 2]
```

Smith Form and Transformation Matrices

Find the Smith form and transformation matrices for an inverse Hilbert matrix.

```
A = sym(invhilb(3));
[U,V,S] = smithForm(A)

U =
[ 1, 1, 1]
[ -4, -1, 0]
[ 10, 5, 3]
```

```
V =
[ 1, -2, 0]
[ 0,  1, 5]
[ 0,  1, 4]
```

```
S =
[ 3,  0,  0]
[ 0, 12,  0]
[ 0,  0, 60]
```

Verify that $S = U*A*V$.

```
isAlways(S == U*A*V)
```

```
ans =
 3x3 logical array
   1   1   1
   1   1   1
   1   1   1
```

Find the Smith form and transformation matrices for a matrix of polynomials.

```
syms x y
A = [2*(x - y), 3*(x^2 - y^2);
     4*(x^3 - y^3), 5*(x^4 - y^4)];
[U,V,S] = smithForm(A,x)
```

```
U =
[ 0, 1]
[ 1, - x/(10*y^3) - 3/(5*y^2)]
```

```
V =
[ -x/(4*y^3), - (5*x*y^2)/2 - (5*x^2*y)/2 - (5*x^3)/2 - (5*y^3)/2]
[ 1/(5*y^3), 2*x^2 + 2*x*y + 2*y^2]
```

```
S =
[ x - y, 0]
[ 0, x^4 + 6*x^3*y - 6*x*y^3 - y^4]
```

Verify that $S = U*A*V$.

```
isAlways(S == U*A*V)
```

```
ans =
 2x2 logical array
   1   1
   1   1
```

If You Specify Variable for Integer Matrix

If a matrix does not contain a particular variable, and you call `smithForm` specifying that variable as the second argument, then the result differs from what you get without specifying that variable. For example, create a matrix that does not contain any variables.

```
A = [9 -36 30; -36 192 -180; 30 -180 180]
```

```
A =
   9  -36  30
```



```
-36  192 -180
 30 -180  180
```

Call `smithForm` specifying variable `x` as the second argument. In this case, `smithForm` assumes that the elements of `A` are univariate polynomials in `x`.

```
syms x
smithForm(A,x)
```

```
ans =
     1     0     0
     0     1     0
     0     0     1
```

Call `smithForm` without specifying variables. In this case, `smithForm` treats `A` as a matrix of integers.

```
smithForm(A)
```

```
ans =
     3     0     0
     0    12     0
     0     0    60
```

Input Arguments

A — Input matrix

square invertible symbolic matrix

Input matrix, specified as a square invertible symbolic matrix, the elements of which are integers or univariate polynomials. If the elements of `A` contain more than one variable, use the `var` argument to specify a polynomial variable, and treat all other variables as symbolic parameters. If `A` is multivariate, and you do not specify `var`, then `smithForm` uses `symvar(A,1)` to determine a polynomial variable.

var — Polynomial variable

symbolic variable

Polynomial variable, specified as a symbolic variable.

Output Arguments

S — Smith normal form of input matrix

symbolic diagonal matrix

Smith normal form of input matrix, returned as a symbolic diagonal matrix. The first diagonal element divides the second, the second divides the third, and so on.

U — Transformation matrix

unimodular symbolic matrix

Transformation matrix, returned as a unimodular symbolic matrix. If elements of `A` are integers, then elements of `U` are also integers, and $\det(U) = 1$ or $\det(U) = -1$. If elements of `A` are polynomials, then elements of `U` are univariate polynomials, and $\det(U)$ is a constant.

V — Transformation matrix

unimodular symbolic matrix

Transformation matrix, returned as a unimodular symbolic matrix. If elements of A are integers, then elements of V are also integers, and $\det(V) = 1$ or $\det(V) = -1$. If elements of A are polynomials, then elements of V are univariate polynomials, and $\det(V)$ is a constant.

More About**Smith Normal Form**

Smith normal form of a an n -by- n matrix A is an n -by- n diagonal matrix S , such that $S_{i,i}$ divides $S_{i+1,i+1}$ for all $i < n$.

See Also

hermiteForm | jordan

Introduced in R2015b

solve

Equations and systems solver

Note Support for character vector or string inputs has been removed. Instead, use `syms` to declare variables and replace inputs such as `solve('2*x == 1', 'x')` with `solve(2*x == 1, x)`.

Syntax

```
S = solve(eqn, var)
S = solve(eqn, var, Name, Value)
```

```
Y = solve(eqns, vars)
Y = solve(eqns, vars, Name, Value)
```

```
[y1, ..., yN] = solve(eqns, vars)
[y1, ..., yN] = solve(eqns, vars, Name, Value)
[y1, ..., yN, parameters, conditions] = solve(eqns, vars, 'ReturnConditions', true)
```

Description

`S = solve(eqn, var)` solves the equation `eqn` for the variable `var`. If you do not specify `var`, the `symvar` function determines the variable to solve for. For example, `solve(x + 1 == 2, x)` solves the equation $x + 1 = 2$ for x .

`S = solve(eqn, var, Name, Value)` uses additional options specified by one or more `Name, Value` pair arguments.

`Y = solve(eqns, vars)` solves the system of equations `eqns` for the variables `vars` and returns a structure that contains the solutions. If you do not specify `vars`, `solve` uses `symvar` to find the variables to solve for. In this case, the number of variables that `symvar` finds is equal to the number of equations `eqns`.

`Y = solve(eqns, vars, Name, Value)` uses additional options specified by one or more `Name, Value` pair arguments.

`[y1, ..., yN] = solve(eqns, vars)` solves the system of equations `eqns` for the variables `vars`. The solutions are assigned to the variables `y1, ..., yN`. If you do not specify the variables, `solve` uses `symvar` to find the variables to solve for. In this case, the number of variables that `symvar` finds is equal to the number of output arguments `N`.

`[y1, ..., yN] = solve(eqns, vars, Name, Value)` uses additional options specified by one or more `Name, Value` pair arguments.

`[y1, ..., yN, parameters, conditions] = solve(eqns, vars, 'ReturnConditions', true)` returns the additional arguments `parameters` and `conditions` that specify the parameters in the solution and the conditions on the solution.

Examples

Solve Quadratic Equation

Solve the quadratic equation without specifying a variable to solve for. `solve` chooses `x` to return the solution.

```
syms a b c x
eqn = a*x^2 + b*x + c == 0
```

$$\text{eqn} = ax^2 + bx + c = 0$$

```
S = solve(eqn)
```

$$S = \begin{pmatrix} -\frac{b + \sqrt{b^2 - 4ac}}{2a} \\ -\frac{b - \sqrt{b^2 - 4ac}}{2a} \end{pmatrix}$$

Specify the variable to solve for and solve the quadratic equation for `a`.

```
Sa = solve(eqn, a)
```

$$S_a = -\frac{c + bx}{x^2}$$

Solve Polynomial and Return Real Solutions

Solve a fifth-degree polynomial. It has five solutions.

```
syms x
eqn = x^5 == 3125;
S = solve(eqn, x)
```

$$S = \begin{pmatrix} 5 \\ -\sigma_1 - \frac{5}{4} - \frac{5\sqrt{2}\sqrt{5 - \sqrt{5}}i}{4} \\ -\sigma_1 - \frac{5}{4} + \frac{5\sqrt{2}\sqrt{5 - \sqrt{5}}i}{4} \\ \sigma_1 - \frac{5}{4} - \frac{5\sqrt{2}\sqrt{\sqrt{5} + 5}i}{4} \\ \sigma_1 - \frac{5}{4} + \frac{5\sqrt{2}\sqrt{\sqrt{5} + 5}i}{4} \end{pmatrix}$$

where

$$\sigma_1 = \frac{5\sqrt{5}}{4}$$

Return only real solutions by setting `'Real'` option to `true`. The only real solutions of this equation is 5.

```
S = solve(eqn, x, 'Real', true)
```

S = 5

Numerically Solve Equations

When `solve` cannot symbolically solve an equation, it tries to find a numeric solution using `vpsolve`. The `vpsolve` function returns the first solution found.

Try solving the following equation. `solve` returns a numeric solution because it cannot find a symbolic solution.

```
syms x
eqn = sin(x) == x^2 - 1;
S = solve(eqn,x)
```

Warning: Unable to solve symbolically. Returning a numeric solution using [matlab:web\(fu](matlab:web(fu)

```
S = -0.63673265080528201088799090383828
```

Plot the left and the right sides of the equation. Observe that the equation also has a positive solution.

```
fplot([lhs(eqn) rhs(eqn)], [-2 2])
```

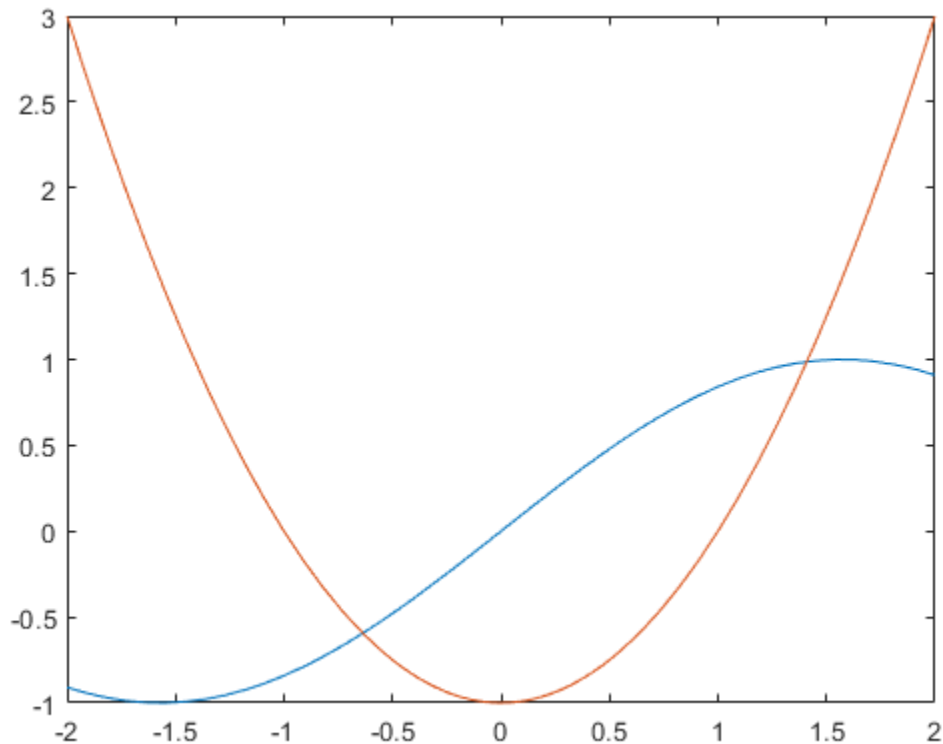

Find the other solution by directly calling the numeric solver `vpsolve` and specifying the interval.

```
V = vpsolve(eqn,x,[0 2])
```

```
V = 1.4096240040025962492355939705895
```

Solve Multivariate Equations and Assign Outputs to Structure

When solving for multiple variables, it can be more convenient to store the outputs in a structure array than in separate variables. The `solve` function returns a structure when you specify a single output argument and multiple outputs exist.

Solve a system of equations to return the solutions in a structure array.

```
syms u v
eqns = [2*u + v == 0, u - v == 1];
S = solve(eqns,[u v])
```

```
S = struct with fields:
  u: [1x1 sym]
  v: [1x1 sym]
```

Access the solutions by addressing the elements of the structure.

```
S.u
```

```
ans =
    1
    3
```

```
S.v
```

```
ans =
   -2
    3
```

Using a structure array allows you to conveniently substitute solutions into other expressions.

Use the `subs` function to substitute the solutions `S` into other expressions.

```
expr1 = u^2;
e1 = subs(expr1,S)
```

```
e1 =
    1
    9
```

```
expr2 = 3*v + u;
e2 = subs(expr2,S)
```

```
e2 =
   -5
    3
```

If `solve` returns an empty object, then no solutions exist.

```
eqns = [3*u+2, 3*u+1];
S = solve(eqns,u)
```

```
S =
```

Empty sym: 0-by-1

Solve Inequalities

The `solve` function can solve inequalities and return solutions that satisfy the inequalities. Solve the following inequalities.

$$x > 0$$

$$y > 0$$

$$x^2 + y^2 + xy < 1$$

Set `'ReturnConditions'` to `true` to return any parameters in the solution and conditions on the solution.

```
syms x y
eqn1 = x > 0;
eqn2 = y > 0;
eqn3 = x^2 + y^2 + x*y < 1;
eqns = [eqn1 eqn2 eqn3];

S = solve(eqns,[x y],'ReturnConditions',true);
S.x
```

$$\text{ans} = \frac{\sqrt{u - 3v^2}}{2} - \frac{v}{2}$$

S.y

$$\text{ans} = v$$

S.parameters

$$\text{ans} = (u \ v)$$

S.conditions

$$\text{ans} = 4v^2 < u \wedge u < 4 \wedge 0 < v$$

The parameters `u` and `v` do not exist in MATLAB® workspace and must be accessed using `S.parameters`.

Check if the values `u = 7/2` and `v = 1/2` satisfy the condition using `subs` and `isAlways`.

```
condWithValues = subs(S.conditions, S.parameters, [7/2,1/2]);
isAlways(condWithValues)
```

$$\text{ans} = \text{logical}$$

$$1$$

`isAlways` returns logical 1 (true) indicating that these values satisfy the condition. Substitute these parameter values into `S.x` and `S.y` to find a solution for `x` and `y`.

```
xSol = subs(S.x, S.parameters, [7/2,1/2])
```

```
xSol =

$$\frac{\sqrt{11}}{4} - \frac{1}{4}$$

```

```
ySol = subs(S.y, S.parameters, [7/2,1/2])
```

```
ySol =

$$\frac{1}{2}$$

```

Solve Multivariate Equations and Assign Outputs to Variables

Solve the system of equations.

$$2u^2 + v^2 = 0$$

$$u - v = 1$$

When solving for more than one variable, the order in which you specify the variables defines the order in which the solver returns the solutions. Assign the solutions to variables `solv` and `solu` by specifying the variables explicitly. The solver returns an array of solutions for each variable.

```
syms u v
eqns = [2*u^2 + v^2 == 0, u - v == 1];
vars = [v u];
[solv, solu] = solve(eqns,vars)
```

```
solv =

$$\begin{pmatrix} -\frac{2}{3} - \frac{\sqrt{2} i}{3} \\ -\frac{2}{3} + \frac{\sqrt{2} i}{3} \end{pmatrix}$$

```

```
solu =

$$\begin{pmatrix} \frac{1}{3} - \frac{\sqrt{2} i}{3} \\ \frac{1}{3} + \frac{\sqrt{2} i}{3} \end{pmatrix}$$

```

Entries with the same index form the pair of solutions.

```
solutions = [solv solu]
```

```
solutions =

$$\begin{pmatrix} -\frac{2}{3} - \frac{\sqrt{2} i}{3} & \frac{1}{3} - \frac{\sqrt{2} i}{3} \\ -\frac{2}{3} + \frac{\sqrt{2} i}{3} & \frac{1}{3} + \frac{\sqrt{2} i}{3} \end{pmatrix}$$

```

Use Parameters and Conditions to Refine Solution

Return the complete solution of an equation with parameters and conditions of the solution by specifying 'ReturnConditions' as true.

Solve the equation $\sin(x) = 0$. Provide two additional output variables for output arguments parameters and conditions.

```
syms x
eqn = sin(x) == 0;
[solx,parameters,conditions] = solve(eqn,x,'ReturnConditions',true)

solx =  $\pi k$ 

parameters = k

conditions =  $k \in \mathbb{Z}$ 
```

The solution πk contains the parameter k , where k must be an integer. The variable k does not exist in MATLAB workspace and must be accessed using parameters.

Restrict the solution to $0 < x < 2\pi$. Find a valid value of k for this restriction. Assume the condition, conditions, and use solve to find k . Substitute the value of k found into the solution for x .

```
assume(conditions)
restriction = [solx > 0, solx < 2*pi];
solk = solve(restriction,parameters)

solk = 1

valx = subs(solx,parameters,solk)

valx =  $\pi$ 
```

Alternatively, determine the solution for x by choosing a value of k . Check if the value chosen satisfies the condition on k using isAlways.

Check if $k = 4$ satisfies the condition on k .

```
condk4 = subs(conditions,parameters,4);
isAlways(condk4)

ans = logical
     1
```

isAlways returns logical 1(true), meaning that 4 is a valid value for k . Substitute k with 4 to obtain a solution for x . Use vpa to obtain a numeric approximation.

```
valx = subs(solx,parameters,4)

valx =  $4\pi$ 

vpa(valx)

ans = 12.566370614359172953850573533118
```

Shorten Result with Simplification Rules

Try to solve the equation $\exp(\log(x)\log(3x)) = 4$. By default, `solve` does not apply simplifications that are not always mathematically correct. As a result, `solve` cannot solve the equation symbolically.

```
syms x
eqn = exp(log(x)*log(3*x)) == 4;
S = solve(eqn,x)
```

Warning: Unable to solve symbolically. Returning a numeric solution using

```
S = -14.009379055223370038369334703094 - 2.9255310052111119036668717988769 i
```

Set `'IgnoreAnalyticConstraints'` to `true` to apply simplification rules that might allow `solve` to find a solution. For details, see “Algorithms” on page 4-1258.

```
S = solve(eqn,x,'IgnoreAnalyticConstraints',true)
```

```
S =
```

$$\begin{pmatrix} \frac{\sqrt{3} e^{-\frac{\sqrt{\log(256) + \log(3)^2}}{2}}}{3} \\ \frac{\sqrt{3} e^{\frac{\sqrt{\log(256) + \log(3)^2}}{2}}}{3} \end{pmatrix}$$

`solve` applies simplifications that allow the solver to find a solution. The mathematical rules applied when performing simplifications are not always valid in general. Thus, the solutions in this mode might not be correct or complete, and need verification.

Ignore Assumptions on Variables

The `sym` and `syms` functions let you set assumptions for symbolic variables.

Assume that the variable `x` is positive.

```
syms x positive
```

When you solve an equation for a variable under assumptions, the solver only returns solutions consistent with the assumptions. Solve this equation for `x`.

```
eqn = x^2 + 5*x - 6 == 0;
S = solve(eqn,x)
```

```
S = 1
```

Allow solutions that do not satisfy the assumptions by setting `'IgnoreProperties'` to `true`.

```
S = solve(eqn,x,'IgnoreProperties',true)
```

```
S =
```

$$\begin{pmatrix} -6 \\ 1 \end{pmatrix}$$

For further computations, clear the assumption that you set on the variable x by recreating it using `syms`.

`syms x`

Solve Polynomial Equations of High Degree

When you solve a polynomial equation, the solver might use `root` to return the solutions. Solve a third-degree polynomial.

```
syms x a
eqn = x^3 + x^2 + a == 0;
solve(eqn, x)
```

```
ans =

$$\begin{pmatrix} \text{root}(z^3 + z^2 + a, z, 1) \\ \text{root}(z^3 + z^2 + a, z, 2) \\ \text{root}(z^3 + z^2 + a, z, 3) \end{pmatrix}$$

```

Try to get an explicit solution for such equations by calling the solver with `'MaxDegree'`. The option specifies the maximum degree of polynomials for which the solver tries to return explicit solutions. The default value is 2. Increasing this value, you can get explicit solutions for higher order polynomials.

Solve the same equations for explicit solutions by increasing the value of `'MaxDegree'` to 3.

```
S = solve(eqn, x, 'MaxDegree', 3)
```

```
S =
```

$$\begin{pmatrix} \frac{1}{9\sigma_1} + \sigma_1 - \frac{1}{3} \\ -\frac{1}{18\sigma_1} - \frac{\sigma_1}{2} - \frac{1}{3} - \frac{\sqrt{3}\left(\frac{1}{9\sigma_1} - \sigma_1\right) i}{2} \\ -\frac{1}{18\sigma_1} - \frac{\sigma_1}{2} - \frac{1}{3} + \frac{\sqrt{3}\left(\frac{1}{9\sigma_1} - \sigma_1\right) i}{2} \end{pmatrix}$$

where

$$\sigma_1 = \left(\sqrt{\left(\frac{a}{2} + \frac{1}{27}\right)^2 - \frac{1}{729} - \frac{a}{2} - \frac{1}{27}} \right)^{1/3}$$

Return One Solution

Solve the equation $\sin(x) + \cos(2x) = 1$.

Instead of returning an infinite set of periodic solutions, the solver picks three solutions that it considers to be the most practical.

```
syms x
eqn = sin(x) + cos(2*x) == 1;
S = solve(eqn,x)
```

```
S =
    ( 0 )
    (  pi )
    (  6 )
    ( 5 pi )
    (  6 )
```

Choose only one solution by setting 'PrincipalValue' to true.

```
S1 = solve(eqn,x,'PrincipalValue',true)
```

```
S1 = 0
```

Input Arguments

eqn — Equation to solve

symbolic expression | symbolic equation

Equation to solve, specified as a symbolic expression or symbolic equation. The relation operator `==` defines symbolic equations. If `eqn` is a symbolic expression (without the right side), the solver assumes that the right side is 0, and solves the equation `eqn == 0`.

var — Variable for which you solve equation

symbolic variable

Variable for which you solve an equation, specified as a symbolic variable. By default, `solve` uses the variable determined by `symvar`.

eqns — System of equations

symbolic expressions | symbolic equations

System of equations, specified as symbolic expressions or symbolic equations. If any elements of `eqns` are symbolic expressions (without the right side), `solve` equates the element to 0.

vars — Variables for which you solve an equation or system of equations

symbolic variables

Variables for which you solve an equation or system of equations, specified as symbolic variables. By default, `solve` uses the variables determined by `symvar`.

The order in which you specify these variables defines the order in which the solver returns the solutions.

Name-Value Pair Arguments

Example: `'Real', true` specifies that the solver returns real solutions.

Real — Flag for returning only real solutions

false (default) | true

Flag for returning only real solutions, specified as the comma-separated pair consisting of 'Real' and one of these values.

false	Return all solutions.
true	Return only those solutions for which every subexpression of the original equation represents a real number. This option also assumes that all symbolic parameters of an equation represent real numbers.

See “Solve Polynomial and Return Real Solutions” on page 4-1246.

ReturnConditions – Flag for returning parameters and conditions

false (default) | true

Flag for returning parameters in solution and conditions under which the solution is true, specified as the comma-separated pair consisting of 'ReturnConditions' and one of these values.

false	Do not return parameterized solutions and the conditions under which the solution holds. The <code>solve</code> function replaces parameters with appropriate values.
true	Return the parameters in the solution and the conditions under which the solution holds. For a call with a single output variable, <code>solve</code> returns a structure with the fields <code>parameters</code> and <code>conditions</code> . For multiple output variables, <code>solve</code> assigns the parameters and conditions to the last two output variables. This behavior means that the number of output variables must be equal to the number of variables to solve for plus two.

See “Solve Inequalities” on page 4-1249.

Example: `[v1, v2, params, conditions] = solve(sin(x) + y == 0, y^2 == 3, 'ReturnConditions', true)` returns the parameters in `params` and conditions in `conditions`.

IgnoreAnalyticConstraints – Simplification rules applied to expressions and equations

false (default) | true

Simplification rules applied to expressions and equations, specified as the comma-separated pair consisting of 'IgnoreAnalyticConstraints' and one of these values.

false	Use strict simplification rules.
true	Apply purely algebraic simplifications to expressions and equations. Setting <code>IgnoreAnalyticConstraints</code> to <code>true</code> can give you simple solutions for the equations for which the direct use of the solver returns complicated results. In some cases, it also enables <code>solve</code> to solve equations and systems that cannot be solved otherwise. However, setting <code>IgnoreAnalyticConstraints</code> to <code>true</code> can lead to wrong or incomplete results.

See “Shorten Result with Simplification Rules” on page 4-1252.

IgnoreProperties – Flag for returning solutions inconsistent with properties of variables

false (default) | true

Flag for returning solutions inconsistent with the properties of variables, specified as the comma-separated pair consisting of 'IgnoreProperties' and one of these values.

<code>false</code>	Do not include solutions inconsistent with the properties of variables.
<code>true</code>	Include solutions inconsistent with the properties of variables.

See “Ignore Assumptions on Variables” on page 4-1252.

MaxDegree — Maximum degree of polynomial equations for which solver uses explicit formulas

2 (default) | positive integer smaller than 5

Maximum degree of polynomial equations for which solver uses explicit formulas, specified as a positive integer smaller than 5. The solver does not use explicit formulas that involve radicals when solving polynomial equations of a degree larger than the specified value.

See “Solve Polynomial Equations of High Degree” on page 4-1253.

PrincipalValue — Flag for returning one solution

`false` (default) | `true`

Flag for returning one solution, specified as the comma-separated pair consisting of 'PrincipalValue' and one of these values.

<code>false</code>	Return all solutions.
<code>true</code>	Return only one solution. If an equation or a system of equations does not have a solution, the solver returns an empty symbolic object.

See “Return One Solution” on page 4-1253.

Output Arguments

S — Solutions of equation

symbolic array

Solutions of an equation, returned as a symbolic array. The size of a symbolic array corresponds to the number of the solutions.

Y — Solutions of system of equations

structure

Solutions of a system of equations, returned as a structure. The number of fields in the structure correspond to the number of independent variables in a system. If 'ReturnConditions' is set to `true`, the `solve` function returns two additional fields that contain the parameters in the solution, and the conditions under which the solution is true.

y1, ..., yN — Solutions of system of equations

symbolic variables

Solutions of a system of equations, returned as symbolic variables. The number of output variables or symbolic arrays must be equal to the number of independent variables in a system. If you explicitly specify independent variables `vars`, then the solver uses the same order to return the solutions. If you do not specify `vars`, the toolbox sorts independent variables alphabetically, and then assigns the solutions for these variables to the output variables.

parameters — Parameters in solution

vector of generated parameters

Parameters in a solution, returned as a vector of generated parameters. This output argument is only returned if `ReturnConditions` is `true`. If a single output argument is provided, `parameters` is returned as a field of a structure. If multiple output arguments are provided, `parameters` is returned as the second-to-last output argument. The generated parameters do not appear in the MATLAB workspace. They must be accessed using `parameters`.

Example: `[solx, params, conditions] = solve(sin(x) == 0, 'ReturnConditions', true)` returns the parameter `k` in the argument `params`.

conditions — Conditions under which solutions are valid

vector of symbolic expressions

Conditions under which solutions are valid, returned as a vector of symbolic expressions. This output argument is only returned if `ReturnConditions` is `true`. If a single output argument is provided, `conditions` is returned as a field of a structure. If multiple output arguments are provided, `conditions` is returned as the last output argument.

Example: `[solx, params, conditions] = solve(sin(x) == 0, 'ReturnConditions', true)` returns the condition `in(k, 'integer')` in `conditions`. The solution in `solx` is valid only under this condition.

Tips

- If `solve` cannot find a solution and `ReturnConditions` is `false`, the `solve` function internally calls the numeric solver `vpasolve` that tries to find a numeric solution. For polynomial equations and systems without symbolic parameters, the numeric solver returns all solutions. For nonpolynomial equations and systems without symbolic parameters, the numeric solver returns only one solution (if a solution exists).
- If `solve` cannot find a solution and `ReturnConditions` is `true`, `solve` returns an empty solution with a warning. If no solutions exist, `solve` returns an empty solution without a warning.
- If the solution contains parameters and `ReturnConditions` is `true`, `solve` returns the parameters in the solution and the conditions under which the solutions are true. If `ReturnConditions` is `false`, the `solve` function either chooses values of the parameters and returns the corresponding results, or returns parameterized solutions without choosing particular values. In the latter case, `solve` also issues a warning indicating the values of parameters in the returned solutions.
- If a parameter does not appear in any condition, it means the parameter can take any complex value.
- The output of `solve` can contain parameters from the input equations in addition to parameters introduced by `solve`.
- Parameters introduced by `solve` do not appear in the MATLAB workspace. They must be accessed using the output argument that contains them. Alternatively, to use the parameters in the MATLAB workspace use `syms` to initialize the parameter. For example, if the parameter is `k`, use `syms k`.
- The variable names `parameters` and `conditions` are not allowed as inputs to `solve`.
- To solve differential equations, use the `dsolve` function.
- When solving a system of equations, always assign the result to output arguments. Output arguments let you access the values of the solutions of a system.

- `MaxDegree` only accepts positive integers smaller than 5 because, in general, there are no explicit expressions for the roots of polynomials of degrees higher than 4.
- The output variables y_1, \dots, y_N do not specify the variables for which `solve` solves equations or systems. If y_1, \dots, y_N are the variables that appear in `eqns`, then there is no guarantee that `solve(eqns)` will assign the solutions to y_1, \dots, y_N using the correct order. Thus, when you run `[b, a] = solve(eqns)`, you might get the solutions for `a` assigned to `b` and vice versa.

To ensure the order of the returned solutions, specify the variables `vars`. For example, the call `[b, a] = solve(eqns, b, a)` assigns the solutions for `a` to `a` and the solutions for `b` to `b`.

Algorithms

When you use `IgnoreAnalyticConstraints`, the solver applies these rules to the expressions on both sides of an equation.

- $\log(a) + \log(b) = \log(a \cdot b)$ for all values of a and b . In particular, the following equality is valid for all values of a , b , and c :

$$(a \cdot b)^c = a^c \cdot b^c.$$

- $\log(a^b) = b \cdot \log(a)$ for all values of a and b . In particular, the following equality is valid for all values of a , b , and c :

$$(a^b)^c = a^{b \cdot c}.$$

- If f and g are standard mathematical functions and $f(g(x)) = x$ for all small positive numbers, $f(g(x)) = x$ is assumed to be valid for all complex values x . In particular:
 - $\log(e^x) = x$
 - $\text{asin}(\sin(x)) = x$, $\text{acos}(\cos(x)) = x$, $\text{atan}(\tan(x)) = x$
 - $\text{asinh}(\sinh(x)) = x$, $\text{acosh}(\cosh(x)) = x$, $\text{atanh}(\tanh(x)) = x$
 - $W_k(x \cdot e^x) = x$ for all branch indices k of the Lambert W function.
- The solver can multiply both sides of an equation by any expression except 0 .
- The solutions of polynomial equations must be complete.

See Also

Functions

`dsolve` | `isolate` | `linsolve` | `root` | `subs` | `symvar` | `vpasolve`

Live Editor Tasks

Solve Symbolic Equation

Topics

“Solve Algebraic Equation” on page 2-153

“Solve System of Algebraic Equations” on page 2-160

“Solve System of Linear Equations” on page 2-173

“Solve Algebraic Equation Using Live Editor Task” on page 2-86

“Select Numeric or Symbolic Solver” on page 2-159

“Troubleshoot Equation Solutions from solve Function” on page 2-169

Introduced before R2006a

Solve Symbolic Equation

Find analytic solutions of symbolic equations in Live Editor

Description

The **Solve Symbolic Equation** task enables you to interactively find analytic solutions of symbolic equations. The task automatically generates MATLAB code for your live script. For more information about Live Editor tasks, see “Add Interactive Tasks to a Live Script” (MATLAB).

Using this task, you can:

- Find analytic solutions of symbolic equations, which include a single equation and a system of algebraic equations.
- Specify the solver options to find solutions.
- Generate the code used to solve equations.

Open the Task

To add the **Solve Symbolic Equation** task to a live script in the MATLAB Editor:

- On the **Live Editor** tab, select **Task > Solve Symbolic Equation**.
- In a code block in your script, type a relevant keyword, such as `solve`, `symbolic`, or `equation`. Select **Solve Symbolic Equation** from the suggested command completions.

Parameters

Return real solutions — Return only real solutions

`off` (default) | `on`

Select this check box to return solutions for which every subexpression of the equation represents a real number. This option assumes all parameters of the equation represent real numbers.

Return one solution — Return one solution

`off` (default) | `on`

Select this check box to return a single solution (principal value). If an equation or a system of equations does not have any solution, the solver returns an empty symbolic object.

Return conditions — Return more general solution and its constraints

`off` (default) | `on`

Select this check box to return the more general solution and the analytic constraints under which the solution holds. This option returns a structure with the fields `parameters` and `conditions` that contain the parameters in the solution and the conditions under which they hold, respectively.

Expand all roots — Expand solutions in terms of square roots

`off` (default) | `on`

Select this check box to express the root function in terms of square roots in the solutions. The results can be lengthy or less accurate for floating-point approximations.

Ignore analytic constraints – Option to ignore analytic constraints

off (default) | on

Select this check box to apply purely algebraic simplifications to give simpler solutions, which could lead to results not generally valid. This option applies mathematical identities that are convenient, but do not always hold for all values of variables. In some cases, it also enables the **Solve Symbolic Equation** task to solve equations and systems that cannot be solved otherwise.

Ignore properties – Option to ignore assumptions on variables to solve for

off (default) | on

Select this check box to ignore assumptions on the variables to solve for. This option may include solutions that are inconsistent with assumptions on the variables to solve for.

See Also**Functions**

solve

Live Editor Tasks

Simplify Symbolic Expression

Topics

“Add Interactive Tasks to a Live Script” (MATLAB)

“Solve Algebraic Equation Using Live Editor Task” on page 2-86

“Solve Algebraic Equation” on page 2-153

Introduced in R2020a

sort

Sort elements of symbolic vectors or matrices

Syntax

```
Y = sort(X)
[Y,I] = sort(____)
____ = sort(X,dim)
____ = sort(____, 'descend')
```

Description

`Y = sort(X)` sorts the elements of a symbolic vector or matrix in ascending order. If `X` is a vector, `sort(X)` sorts the elements of `X` in lexicographic order. If `X` is a matrix, `sort(X)` sorts each column of `X`.

`[Y,I] = sort(____)` shows the indices that each element of `Y` had in the original vector or matrix `X`.

If `X` is an `m`-by-`n` matrix and you sort elements of each column (`dim = 2`), then each column of `I` is a permutation vector of the corresponding column of `X`, such that

```
for j = 1:n
    Y(:,j) = X(I(:,j),j);
end
```

If `X` is a two-dimensional matrix, and you sort the elements of each column, the array `I` shows the row indices that the elements of `Y` had in the original matrix `X`. If you sort the elements of each row, `I` shows the original column indices.

`____ = sort(X,dim)` sorts the elements of `X` along the dimension `dim`. Thus, if `X` is a two-dimensional matrix, then `sort(X,1)` sorts elements of each column of `X`, and `sort(X,2)` sorts elements of each row.

`____ = sort(____, 'descend')` sorts `X` in descending order. By default, `sort` uses ascending order.

Examples

Sort Vector Elements

By default, `sort` sorts the element of a vector or a matrix in ascending order.

Sort the elements of the following symbolic vector:

```
syms a b c d e
sort([7 e 1 c 5 d a b])

ans =
[ 1, 5, 7, a, b, c, d, e]
```

Find Indices That Elements of Sorted Matrix Had in Original Matrix

To find the indices that each element of a new vector or matrix `Y` had in the original vector or matrix `X`, call `sort` with two output arguments.

Sort the matrix `X` returning the matrix of indices that each element of the sorted matrix had in `X`:

```
X = sym(magic(3));
[Y, I] = sort(X)
```

```
Y =
 [ 3, 1, 2]
 [ 4, 5, 6]
 [ 8, 9, 7]
```

```
I =
     2     1     3
     3     2     1
     1     3     2
```

Sort Matrix Along Its Columns and Rows

When sorting elements of a matrix, `sort` can work along the columns or rows of that matrix.

Sort the elements of the following symbolic matrix:

```
X = sym(magic(3))
```

```
X =
 [ 8, 1, 6]
 [ 3, 5, 7]
 [ 4, 9, 2]
```

By default, the `sort` command sorts elements of each column:

```
sort(X)

ans =
 [ 3, 1, 2]
 [ 4, 5, 6]
 [ 8, 9, 7]
```

To sort the elements of each row, use set the value of the `dim` option to 2:

```
sort(X,2)

ans =
 [ 1, 6, 8]
 [ 3, 5, 7]
 [ 2, 4, 9]
```

Sort in Descending Order

`sort` can sort the elements of a vector or a matrix in descending order.

Sort the elements of this vector in descending order:

```
syms a b c d e
sort([7 e 1 c 5 d a b], 'descend')
```

```
ans =  
[ e, d, c, b, a, 7, 5, 1 ]
```

Sort the elements of each column of this matrix *X* in descending order:

```
X = sym(magic(3))  
sort(X, 'descend')
```

```
X =  
[ 8, 1, 6 ]  
[ 3, 5, 7 ]  
[ 4, 9, 2 ]
```

```
ans =  
[ 8, 9, 7 ]  
[ 4, 5, 6 ]  
[ 3, 1, 2 ]
```

Now, sort the elements of each row of *X* in descending order:

```
sort(X, 2, 'descend')
```

```
ans =  
[ 8, 6, 1 ]  
[ 7, 5, 3 ]  
[ 9, 4, 2 ]
```

Input Arguments

X — Input that needs to be sorted

symbolic vector | symbolic matrix

Input that needs to be sorted, specified as a symbolic vector or matrix.

dim — Dimension to operate along

positive integer

Dimension to operate along, specified as a positive integer. The default value is 1. If *dim* exceeds the number of dimensions of *X*, then `sort(X,dim)` returns *X*, and `[Y,I] = sort(X,dim)` returns *Y* = *X* and *I* = `ones(size(X))`.

Output Arguments

Y — Sorted output

symbolic vector | symbolic matrix

Sorted output, returned as a symbolic vector or matrix.

I — Indices that elements of *Y* had in *X*

symbolic vector | symbolic matrix

Indices that elements of *Y* had in *X*, returned as a symbolic vector or matrix. `[Y,I] = sort(X,dim)` also returns matrix *I* = `ones(size(X))` if the value *dim* exceeds the number of dimensions of *X*.

Tips

- Calling `sort` for vectors or matrices of numbers that are not symbolic objects invokes the MATLAB `sort` function.
- For complex input X , `sort` compares elements by their magnitudes (complex moduli), computed with `abs(X)`. If complex numbers have the same complex modulus, `sort` compares their phase angles, `angle(X)`.
- If you use `'ascend'` instead of `'descend'`, then `sort` returns elements in ascending order, as it does by default.
- `sort` uses the following rules:
 - It sorts symbolic numbers and floating-point numbers numerically.
 - It sorts symbolic variables alphabetically.
 - In all other cases, including symbolic expressions and functions, `sort` uses internal sorting rules.

Introduced before R2006a

sqrtm

Matrix square root

Syntax

```
X = sqrtm(A)
[X,resnorm] = sqrtm(A)
```

Description

`X = sqrtm(A)` returns a matrix X , such that $X^2 = A$ and the eigenvalues of X are the square roots of the eigenvalues of A .

`[X,resnorm] = sqrtm(A)` returns a matrix X and the residual norm $(A-X^2, 'fro') / \text{norm}(A, 'fro')$.

Examples

Compute Square Root of Matrix

Compute the square root of this matrix. Because these numbers are not symbolic objects, you get floating-point results.

```
A = [2 -2 0; -1 3 0; -1/3 5/3 2];
X = sqrtm(A)
```

```
X =
    1.3333    -0.6667     0.0000
   -0.3333     1.6667    -0.0000
   -0.0572     0.5286     1.4142
```

Now, convert this matrix to a symbolic object, and compute its square root again:

```
A = sym([2 -2 0; -1 3 0; -1/3 5/3 2]);
X = sqrtm(A)
```

```
X =
[
    4/3,      -2/3,      0]
[
   -1/3,      5/3,      0]
[ (2*2^(1/2))/3 - 1, 1 - 2^(1/2)/3, 2^(1/2)]
```

Check the correctness of the result:

```
isAlways(X^2 == A)
```

```
ans =
    3×3 logical array
    1     1     1
    1     1     1
    1     1     1
```

Return Residual of Matrix Square Root

Use the syntax with two output arguments to return the square root of a matrix and the residual:

```
A = vpa(sym([0 0; 0 5/3]), 100);  
[X, resnorm] = sqrtm(A)
```

```
X =  
[ 0, 0]  
[ 0, 1.2909944487358056283930884665941]
```

```
resnorm =  
2.9387358770557187699218413430556e-40
```

Input Arguments

A — Input

symbolic matrix

Input, specified as a symbolic matrix.

Output Arguments

X — Matrix square root

symbolic matrix

Matrix square root, returned as a symbolic matrix such that $X^2 = A$.

resnorm — Residual

symbolic expression

Residual, returned as a symbolic expression. The residual is computed as $\text{norm}(A - X^2, 'fro') / \text{norm}(A, 'fro')$.

Tips

- Calling `sqrtm` for a matrix that is not a symbolic object invokes the MATLAB `sqrtm` function.

See Also

`cond` | `eig` | `expm` | `funm` | `jordan` | `logm` | `norm`

Introduced in R2013a

ssinint

Shifted sine integral function

Syntax

```
ssinint(X)
```

Description

`ssinint(X)` returns the shifted sine integral function on page 4-1270 $\text{ssinint}(X) = \text{sinint}(X) - \pi/2$.

Examples

Shifted Sine Integral Function for Numeric and Symbolic Arguments

Depending on its arguments, `ssinint` returns floating-point or exact symbolic results.

Compute the shifted sine integral function for these numbers. Because these numbers are not symbolic objects, `ssinint` returns floating-point results.

```
A = ssinint([- pi, 0, pi/2, pi, 1])
A =
    -3.4227    -1.5708    -0.2000     0.2811    -0.6247
```

Compute the shifted sine integral function for the numbers converted to symbolic objects. For many symbolic (exact) numbers, `ssinint` returns unresolved symbolic calls.

```
symA = ssinint(sym([- pi, 0, pi/2, pi, 1]))
symA =
[ - pi - ssinint(pi), -pi/2, ssinint(pi/2), ssinint(pi), ssinint(1)]
```

Use `vpa` to approximate symbolic results with floating-point numbers:

```
vpa(symA)
ans =
[ -3.4227333787773627895923750617977,...
 -1.5707963267948966192313216916398,...
 -0.20003415864040813916164340325818,...
 0.28114072518756955112973167851824,...
 -0.62471325642771360428996837781657]
```

Plot Shifted Sine Integral Function

Plot the shifted sine integral function on the interval from -4π to 4π .

```
syms x
fplot(ssinint(x),[-4*pi 4*pi])
grid on
```

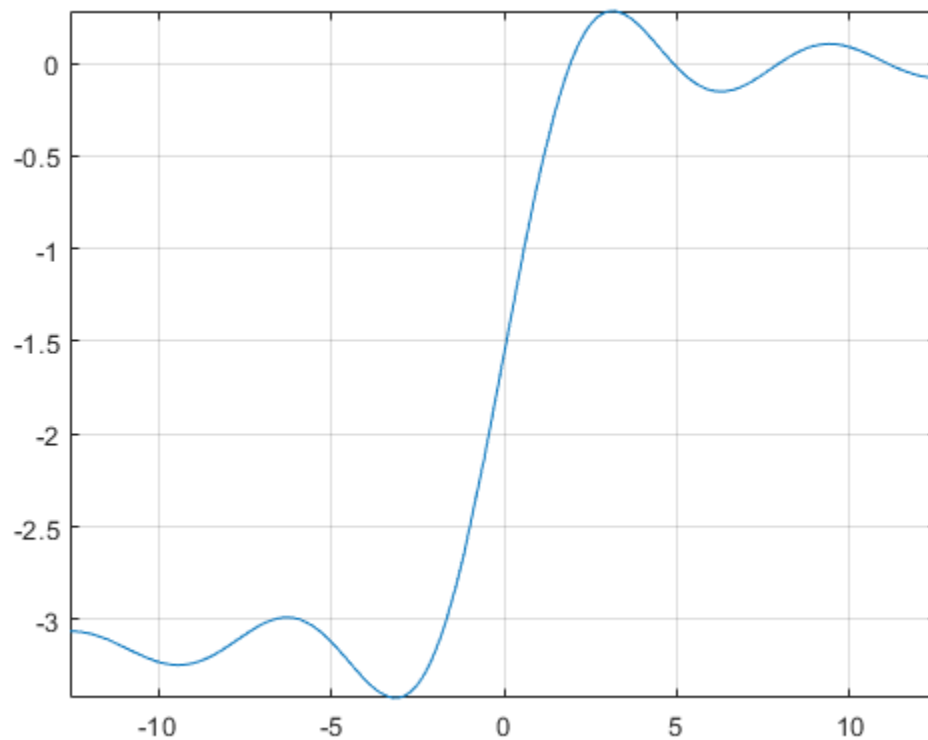

Handle Expressions Containing Shifted Sine Integral Function

Many functions, such as `diff`, `int`, and `taylor`, can handle expressions containing `ssinint`.

Find the first and second derivatives of the shifted sine integral function:

```
syms x
diff(ssinint(x), x)
diff(ssinint(x), x, x)
```

```
ans =
sin(x)/x
```

```
ans =
cos(x)/x - sin(x)/x^2
```

Find the indefinite integral of the shifted sine integral function:

```
int(ssinint(x), x)
```

```
ans =
cos(x) + x*ssinint(x)
```

Find the Taylor series expansion of `ssinint(x)`:

```
taylor(ssinint(x), x)
```

ans =
 $x^5/600 - x^3/18 + x - \pi/2$

Input Arguments

X — Input

symbolic number | symbolic variable | symbolic expression | symbolic function | symbolic vector | symbolic matrix

Input, specified as a symbolic number, variable, expression, or function, or as a vector or matrix of symbolic numbers, variables, expressions, or functions.

More About

Sine Integral Function

The sine integral function is defined as follows:

$$\text{Si}(x) = \int_0^x \frac{\sin(t)}{t} dt$$

Shifted Sine Integral Function

The sine integral function is defined as $\text{Ssi}(x) = \text{Si}(x) - \pi/2$.

References

- [1] Gautschi, W. and W. F. Cahill. "Exponential Integral and Related Functions." *Handbook of Mathematical Functions with Formulas, Graphs, and Mathematical Tables*. (M. Abramowitz and I. A. Stegun, eds.). New York: Dover, 1972.

See Also

coshint | cosint | eulergamma | int | sin | sinhint | sinhint | sinint

Introduced in R2014a

str2symunit

Convert character vector or string to unit

Syntax

```
str2symunit(unitStr)
str2symunit(unitStr,toolbox)
```

Description

`str2symunit(unitStr)` converts the character vector or string `unitStr` to symbolic units.

`str2symunit(unitStr,toolbox)` converts the character vector `unitStr` assuming it represents units in the toolbox `toolbox`. The allowed values of `toolbox` are 'Aerospace', 'SimBiology', 'Simscape', or 'Simulink'.

Examples

Convert Character Vector to Unit

Convert the character vector 'km/hour' to symbolic units.

```
unit = str2symunit('km/hour')

unit =
1*([km]/[h])
```

Use this unit to define a speed of 50 km/hour.

```
speed = 50*unit

speed =
50*([km]/[h])
```

Convert Units of Specified Toolbox

Convert units from other toolboxes to symbolic units by specifying the toolbox name as the second argument to `str2symunit`. The allowed names are 'Aerospace', 'SimBiology', 'Simscape', or 'Simulink'.

Convert 'km/h-s' from Aerospace Toolbox to symbolic units.

```
unit = str2symunit('km/h-s','Aerospace')

unit =
1*([km]/([h]*[s]))
```

Convert 'molecule/s' from SimBiology® to symbolic units.

```
unit = str2symunit('molecule/s','SimBiology')

unit =
1*([molecule]/[s])
```

Convert 'gee/km' from Simscape to symbolic units.

```
unit = str2symunit('gee/km','Simscape')
```

```
unit =  
1*([g_n]/[km])
```

Convert 'rad/second' from Simulink to symbolic units.

```
unit = str2symunit('rad/second','Simulink')
```

```
unit =  
1*([rad]/[s])
```

Input Arguments

unitStr — Input units

character vector | string

Input, specified as a character vector or string.

Example: `str2symunit('km/hour')`

toolbox — Toolbox to which units belong

'Aerospace' | 'SimBiology' | 'Simscape' | 'Simulink'

Toolbox to which input belongs, specified as 'Aerospace', 'SimBiology', 'Simscape', or 'Simulink'.

Example: `str2symunit('km/h-s', 'Aerospace')`

See Also

`checkUnits` | `findUnits` | `isUnit` | `newUnit` | `separateUnits` | `symunit` | `symunit2str` | `unitConversionFactor`

Topics

“Units of Measurement Tutorial” on page 2-19

“Unit Conversions and Unit Systems” on page 2-39

“Units and Unit Systems List” on page 2-25

External Websites

The International System of Units (SI)

Introduced in R2017a

str2sym

Evaluate string representing symbolic expression

Syntax

```
str2sym(symstr)
```

Description

`str2sym(symstr)` evaluates `symstr` where `symstr` is a string representing a symbolic expression. Enter symbolic expressions as strings only when reading expressions from text files or when specifying numbers exactly. Otherwise, do not use strings for symbolic input.

Examples

Evaluate String as Symbolic Expression

Evaluate the string `'sin(pi)'`. `str2sym` returns the expected result.

```
str2sym('sin(pi)')
```

```
ans =  
0
```

`str2sym` assumes the `=` operator represents an equation, not an assignment. Also, `str2sym` does not add the variables contained in the string to the workspace.

Show this behavior by evaluating `'x^2 = 4'`. The `str2sym` function returns the equation `x^2 == 4` but `x` does not appear in the workspace.

```
eqn = str2sym('x^2 = 4')
```

```
eqn =  
x^2 == 4
```

Find the variable in `eqn` by using `symvar`. The variable `var` now refers to `x`.

```
var = symvar(eqn)
```

```
var =  
x
```

Assign values from `eqn` by solving `eqn` for `var` and assigning the result.

```
varVal = solve(eqn,var)
```

```
varVal =  
-2  
2
```

Substitute Workspace Values into String Input

`str2sym` does not substitute values from the workspace for variables in the input. Therefore, `str2sym` has reproducible output. Instead, substitute workspace values by using `subs` on the output of `str2sym`.

Set `y` to 2. Then, evaluate `'y^2'` with and without `subs` to show how `subs` substitutes `y` with its value.

```
y = 2;
withoutSubs = str2sym('y^2')

withoutSubs =
y^2

withSubs = subs(str2sym('y^2'))

withSubs =
4
```

Evaluate Strings from File as Symbolic Expressions

When symbolic expressions are stored as strings in a file, evaluate the strings by reading the file and using `str2sym`.

Assume the file `mySym.txt` contains this text.

```
a = 2.431
y = a*exp(t)
diff(z(t),t) = b*y*z
```

Evaluate expressions in `mySym.txt` using `str2sym`.

```
filename = 'mySym.txt';
filetext = fileread(filename);
filetext = splitlines(filetext);
str2sym(filetext)

ans =
      a == 2.431
      y == a*exp(t)
diff(z(t), t) == b*y*z
```

The output of `str2sym` is independent of workspace values, which means the output is reproducible. Show this reproducibility by assigning a value to `b` and re-evaluating the stored expressions.

```
b = 5;
str2sym(filetext)

ans =
      a == 2.431
      y == a*exp(t)
diff(z(t), t) == b*y*z
```

To use workspace values or a value from input equations, use `subs` (solve the equation first using `solve`), as described in “Evaluate String as Symbolic Expression” on page 4-1273 and “Substitute Workspace Values into String Input” on page 4-1273.

Execute Functions in String Input

`str2sym` executes functions in input when the functions are on the path. Otherwise, `str2sym` returns the symbolic object as expected. This behavior means that the output is reproducible.

Show this behavior by reading a differential equation and initial condition from a file. Solve the equation for the condition. Because `str2sym` does not evaluate $y(t)$ in the equation, the output is reproducible.

```
filename = 'mySym.txt';
filetext = fileread(filename);
filetext = splitlines(filetext);
eqn = str2sym(filetext(1))

eqn =
diff(y(t), t) == -y(t)

cond = str2sym(filetext(2))

cond =
y(0) == 2

ySol = dsolve(eqn,cond)

ySol =
2*exp(-t)
```

Exactly Represent Large Numbers and High-Precision Numbers

Because the MATLAB parser automatically converts all numbers to double precision, maintain original precision by entering large numbers and high-precision numbers as strings. Instead of `str2sym`, enter integers using `sym` and floating-point numbers using `vpa` because `sym` and `vpa` are faster.

Show the error between entering a ratio of large integers directly versus the exact string representation.

```
num = sym(12230984290/38490293482)

num =
5724399718238385/18014398509481984

numExact = sym('12230984290/38490293482')

numExact =
6115492145/19245146741

error = num - numExact

error =
-7827162395/346689742765832461975814144
```

Show the error between entering a high-precision number directly versus the exact string representation.

```
num = vpa(8.023098429038490293482)

num =
8.0230984290384910195825796108693

numExact = vpa('8.023098429038490293482')

numExact =
8.023098429038490293482

error = num - numExact

error =
0.000000000000000072610057961086928844451883343504
```

For details, see “Numeric to Symbolic Conversion” on page 2-136. For full workflows, see “Numerical Computations With High Precision” and “Prime Factorizations”.

Convert Hexadecimal and Binary Values to Symbolic Decimal Numbers

Starting in R2019b, you can represent hexadecimal and binary values using character vectors. Hexadecimal values start with a `0x` or `0X` prefix, while binary values start with a `0b` or `0B` prefix. You can then convert the hexadecimal and binary values to symbolic decimal numbers using `str2sym`. For more information, see “Hexadecimal and Binary Values” (MATLAB).

Create a character vector that represents a hexadecimal value. Convert the value to symbolic decimal number.

```
H = '0x2A'
D = str2sym(H)

D =
42
```

Create a character vector that represents a binary value. Convert the value to symbolic decimal number.

```
B = '0b101010'
D = str2sym(B)

D =
42
```

Input Arguments

symstr — String representing symbolic expression

character vector | string | cell array of character vectors

String representing a symbolic expression, specified as a character vector, string, or cell array of character vectors.

Tips

- `str2sym` assumes the `=` operator represents an equation, not an assignment.
- `str2sym` does not create variables contained in the input.
- `str2sym('inf')` returns infinity (`Inf`).
- `str2sym('i')` returns the imaginary number `1i`.

See Also

`subs` | `sym` | `syms` | `vpa`

Topics

"Numeric to Symbolic Conversion" on page 2-136

Introduced in R2017b

subexpr

Rewrite symbolic expression in terms of common subexpressions

Syntax

```
[r,sigma] = subexpr(expr)
[r,var] = subexpr(expr,'var')
[r,var] = subexpr(expr,var)
```

Description

`[r,sigma] = subexpr(expr)` rewrites the symbolic expression `expr` in terms of a common subexpression, substituting this common subexpression with the symbolic variable `sigma`. The input expression `expr` cannot contain the variable `sigma`.

`[r,var] = subexpr(expr,'var')` substitutes the common subexpression by `var`. The input expression `expr` cannot contain the symbolic variable `var`.

`[r,var] = subexpr(expr,var)` is equivalent to `[r,var] = subexpr(expr,'var')`, except that the symbolic variable `var` must already exist in the MATLAB workspace.

This syntax overwrites the value of the variable `var` with the common subexpression found in `expr`. To avoid overwriting the value of `var`, use another variable name as the second output argument. For example, use `[r,var1] = subexpr(expr,var)`.

Examples

Rewrite Expression Using Abbreviations

Solve the following equation. The solutions are very long expressions. To display the solutions, remove the semicolon at the end of the `solve` command.

```
syms a b c d x
solutions = solve(a*x^3 + b*x^2 + c*x + d == 0, x, 'MaxDegree', 3);
```

These long expressions have common subexpressions. To shorten the expressions, abbreviate the common subexpression by using `subexpr`. If you do not specify the variable to use for abbreviations as the second input argument of `subexpr`, then `subexpr` uses the variable `sigma`.

```
[r, sigma] = subexpr(solutions)
```

```
r =
```

$$\begin{pmatrix} \sigma - \frac{b}{3a} - \frac{\sigma_2}{\sigma} \\ \frac{\sigma_2}{2\sigma} - \frac{b}{3a} - \frac{\sigma}{2} - \sigma_1 \\ \frac{\sigma_2}{2\sigma} - \frac{b}{3a} - \frac{\sigma}{2} + \sigma_1 \end{pmatrix}$$

where

$$\sigma_1 = \frac{\sqrt{3}\left(\sigma + \frac{\sigma_2}{\sigma}\right) i}{2}$$

$$\sigma_2 = \frac{c}{3a} - \frac{b^2}{9a^2}$$

sigma =

$$\left(\sqrt{\left(\frac{d}{2a} + \frac{b^3}{27a^3} - \frac{bc}{6a^2}\right)^2 + \left(\frac{c}{3a} - \frac{b^2}{9a^2}\right)^3} - \frac{b^3}{27a^3} - \frac{d}{2a} + \frac{bc}{6a^2} \right)^{1/3}$$

Customize Abbreviation Variables

Solve a quadratic equation.

`syms a b c x`

`solutions = solve(a*x^2 + b*x + c == 0, x)`

`solutions =`

$$\begin{pmatrix} -\frac{b + \sqrt{b^2 - 4ac}}{2a} \\ -\frac{b - \sqrt{b^2 - 4ac}}{2a} \end{pmatrix}$$

Use `syms` to create the symbolic variable `s`, and then replace common subexpressions in the result with this variable.

`syms s`

`[abbrSolutions,s] = subexpr(solutions,s)`

`abbrSolutions =`

$$\begin{pmatrix} -\frac{b + s}{2a} \\ -\frac{b - s}{2a} \end{pmatrix}$$

$$s = \sqrt{b^2 - 4ac}$$

Alternatively, use `'s'` to specify the abbreviation variable.

`[abbrSolutions,s] = subexpr(solutions,'s')`

`abbrSolutions =`

$$\begin{pmatrix} -\frac{b+s}{2a} \\ -\frac{b-s}{2a} \end{pmatrix}$$

$$s = \sqrt{b^2 - 4ac}$$

Both syntaxes overwrite the value of the variable `s` with the common subexpression. Therefore, you cannot, for example, substitute `s` with some value.

```
subs(abbrSolutions,s,0)
```

```
ans =
```

$$\begin{pmatrix} -\frac{b+s}{2a} \\ -\frac{b-s}{2a} \end{pmatrix}$$

To avoid overwriting the value of the variable `s`, use another variable name for the second output argument.

```
syms s
[abbrSolutions,t] = subexpr(solutions,'s')
```

```
abbrSolutions =
```

$$\begin{pmatrix} -\frac{b+s}{2a} \\ -\frac{b-s}{2a} \end{pmatrix}$$

```
t =
```

$$\sqrt{b^2 - 4ac}$$

```
subs(abbrSolutions,s,0)
```

```
ans =
```

$$\begin{pmatrix} -\frac{b}{2a} \\ -\frac{b}{2a} \end{pmatrix}$$

Input Arguments

expr — Long expression containing common subexpressions

symbolic expression | symbolic function

Long expression containing common subexpressions, specified as a symbolic expression or function.

var — Variable to use for substituting common subexpressions

character vector | symbolic variable

Variable to use for substituting common subexpressions, specified as a character vector or symbolic variable.

`subexpr` throws an error if the input expression `expr` already contains `var`.

Output Arguments

r — Expression with common subexpressions replaced by abbreviations

symbolic expression | symbolic function

Expression with common subexpressions replaced by abbreviations, returned as a symbolic expression or function.

var — Variable used for abbreviations

symbolic variable

Variable used for abbreviations, returned as a symbolic variable.

See Also

children | simplify | subs

Topics

“Abbreviate Common Terms in Long Expressions” on page 2-101

Introduced before R2006a

subs

Symbolic substitution

Syntax

```
subs(s,old,new)
subs(s,new)
subs(s)
```

Description

`subs(s,old,new)` returns a copy of `s`, replacing all occurrences of `old` with `new`, and then evaluates `s`.

`subs(s,new)` returns a copy of `s`, replacing all occurrences of the default variable in `s` with `new`, and then evaluates `s`. The default variable is defined by `symvar`.

`subs(s)` returns a copy of `s`, replacing symbolic variables in `s`, with their values obtained from the calling function and the MATLAB Workspace, and then evaluates `s`. Variables with no assigned values remain as variables.

Examples

Single Substitution

Replace `a` with `4` in this expression.

```
syms a b
subs(a + b, a, 4)
```

```
ans =
b + 4
```

Replace `a*b` with `5` in this expression.

```
subs(a*b^2, a*b, 5)
```

```
ans =
5*b
```

Default Substitution Variable

Substitute the default variable in this expression with `a`. If you do not specify the variable or expression to replace, `subs` uses `symvar` to find the default variable. For `x + y`, the default variable is `x`.

```
syms x y a
symvar(x + y, 1)
```

```
ans =
x
```

Therefore, `subs` replaces `x` with `a`.

```
subs(x + y, a)
```

```
ans =  
a + y
```

Evaluate Expression with New Values

When you assign a new value to a symbolic variable, expressions containing the variable are not automatically evaluated. Instead, evaluate expressions by using `subs`.

Define the expression `y = x^2`.

```
syms x  
y = x^2;
```

Assign 2 to `x`. The value of `y` is still `x^2` instead of 4.

```
x = 2;  
y
```

```
y =  
x^2
```

Evaluate `y` with the new value of `x` by using `subs`.

```
subs(y)
```

```
ans =  
4
```

Multiple Substitutions

Make multiple substitutions by specifying the old and new values as vectors.

```
syms a b  
subs(cos(a) + sin(b), [a, b], [sym('alpha'), 2])
```

```
ans =  
sin(2) + cos(alpha)
```

Alternatively, for multiple substitutions, use cell arrays.

```
subs(cos(a) + sin(b), {a, b}, {sym('alpha'), 2})
```

```
ans =  
sin(2) + cos(alpha)
```

Substitute Scalars with Arrays

Replace variable `a` in this expression with the 3-by-3 magic square matrix. Note that the constant 1 expands to the 3-by-3 matrix with all its elements equal to 1.

```
syms a t  
subs(exp(a*t) + 1, a, -magic(3))
```

```
ans =  
[ exp(-8*t) + 1, exp(-t) + 1, exp(-6*t) + 1]
```

```
[ exp(-3*t) + 1, exp(-5*t) + 1, exp(-7*t) + 1]
[ exp(-4*t) + 1, exp(-9*t) + 1, exp(-2*t) + 1]
```

You can also replace an element of a vector, matrix, or array with a nonscalar value. For example, create these 2-by-2 matrices.

```
A = sym('A', [2,2])
B = sym('B', [2,2])
```

```
A =
[ A1_1, A1_2]
[ A2_1, A2_2]
```

```
B =
[ B1_1, B1_2]
[ B2_1, B2_2]
```

Replace the first element of the matrix A with the matrix B. While making this substitution, `subs` expands the 2-by-2 matrix A into this 4-by-4 matrix.

```
A44 = subs(A, A(1,1), B)
```

```
A44 =
[ B1_1, B1_2, A1_2, A1_2]
[ B2_1, B2_2, A1_2, A1_2]
[ A2_1, A2_1, A2_2, A2_2]
[ A2_1, A2_1, A2_2, A2_2]
```

`subs` does not let you replace a nonscalar with a scalar.

Substitute Multiple Scalars with Arrays

Replace variables `x` and `y` with these 2-by-2 matrices. When you make multiple substitutions involving vectors or matrices, use cell arrays to specify the old and new values.

```
syms x y
subs(x*y, {x, y}, {[0 1; -1 0], [1 -1; -2 1]})
```

```
ans =
[ 0, -1]
[ 2,  0]
```

Note that these substitutions are element-wise.

```
[0 1; -1 0].*[1 -1; -2 1]
```

```
ans =
  0   -1
  2    0
```

Substitutions in Equations

Eliminate variables from an equation by using the variable's value from another equation. In the second equation, isolate the variable on the left side using `isolate`, and then substitute the right side with the variable in the first equation.

First, declare the equations `eqn1` and `eqn2`.

```
syms x y
eqn1 = sin(x)+y == x^2 + y^2;
eqn2 = y*x == cos(x);
```

Isolate y in eqn2 by using `isolate`.

```
eqn2 = isolate(eqn2,y)

eqn2 =
y == cos(x)/x
```

Eliminate y from eqn1 by substituting the right side of eqn2 with the left side of eqn2 in eqn1.

```
eqn1 = subs(eqn1, lhs(eqn2), rhs(eqn2))

eqn1 =
sin(x) + cos(x)/x == cos(x)^2/x^2 + x^2
```

Substitutions in Functions

Replace x with a in this symbolic function.

```
syms x y a
syms f(x, y)
f(x, y) = x + y;
f = subs(f, x, a)

f(x, y) =
a + y
```

`subs` replaces the values in the symbolic function formula, but does not replace input arguments of the function.

```
formula(f)
argnames(f)

ans =
a + y

ans =
[ x, y]
```

Replace the arguments of a symbolic function explicitly.

```
syms x y
f(x, y) = x + y;
f(a, y) = subs(f, x, a);
f

f(a, y) =
a + y
```

Substitute Variables with Corresponding Values from Structure

Suppose you want to verify the solutions of this system of equations.

```
syms x y
eqs = [x^2 + y^2 == 1, x == y];
S = solve(eqs, [x y]);
```

```
S.x
S.y

ans =
-2^(1/2)/2
 2^(1/2)/2
ans =
-2^(1/2)/2
 2^(1/2)/2
```

Verify the solutions by substituting the solutions into the original system.

```
isAlways(subs(eqs, S))
```

```
ans =
 2x2 logical array
 1 1
 1 1
```

Input Arguments

s — Input

symbolic variable | symbolic expression | symbolic equation | symbolic function | symbolic array | symbolic matrix

Input, specified as a symbolic variable, expression, equation, function, array, or matrix.

old — Element to substitute

symbolic variable | symbolic expression | symbolic array

Element to substitute, specified as a symbolic variable, expression, or array.

new — New element

number | symbolic number | symbolic variable | symbolic expression | symbolic array | structure

New element to substitute with, specified as a number, symbolic number, variable, expression, array, or a structure.

Tips

- `subs(s,old,new)` does not modify `s`. To modify `s`, use `s = subs(s,old,new)`.
- If `old` and `new` are both vectors or cell arrays of the same size, `subs` replaces each element of `old` with the corresponding element of `new`.
- If `old` is a scalar, and `new` is a vector or matrix, then `subs(s,old,new)` replaces all instances of `old` in `s` with `new`, performing all operations element-wise. All constant terms in `s` are replaced with the constant multiplied by a vector or matrix of all 1s.
- If `s` is a univariate polynomial and `new` is a numeric matrix, use `polyvalm(sym2poly(s), new)` to evaluate `s` as a matrix. All constant terms are replaced with the constant multiplied by an identity matrix.

See Also

`double` | `lhs` | `rhs` | `simplify` | `subexpr` | `vpa`

Topics

"Substitutions in Symbolic Expressions" on page 1-16

"Substitute Variables in Symbolic Expressions" on page 2-117

"Substitute Elements in Symbolic Matrices" on page 2-119

"Substitute Scalars with Matrices" on page 2-121

"Evaluate Symbolic Expressions Using subs" on page 2-123

Introduced before R2006a

svd

Singular value decomposition of symbolic matrix

Syntax

```
sigma = svd(A)
[U,S,V] = svd(A)
[U,S,V] = svd(A,theta)
[U,S,V] = svd(A,'econ')
```

Description

`sigma = svd(A)` returns a vector `sigma` containing the singular values of a symbolic matrix `A`.

`[U,S,V] = svd(A)` returns numeric unitary matrices `U` and `V` with the columns containing the singular vectors, and a diagonal matrix `S` containing the singular values. The matrices satisfy the condition $A = U*S*V'$, where `V'` is the Hermitian transpose (the complex conjugate transpose) of `V`. The singular vector computation uses variable-precision arithmetic. `svd` does not compute symbolic singular vectors. Therefore, the input matrix `A` must be convertible to floating-point numbers. For example, it can be a matrix of symbolic numbers.

`[U,S,V] = svd(A,theta)` returns the thin, or economy, SVD. If `A` is an m -by- n matrix with $m > n$, then `svd` computes only the first n columns of `U`. In this case, `S` is an n -by- n matrix. For $m \leq n$, this syntax is equivalent to `svd(A)`.

`[U,S,V] = svd(A,'econ')` also returns the thin, or economy, SVD. If `A` is an m -by- n matrix with $m \geq n$, then this syntax is equivalent to `svd(A,theta)`. For $m < n$, `svd` computes only the first m columns of `V`. In this case, `S` is an m -by- m matrix.

Examples

Symbolic Singular Values

Compute the singular values of the symbolic 5-by-5 magic square:

```
A = sym(magic(5));
sigma = svd(A)

sigma =

          65
5^(1/2)*(1345^(1/2) + 65)^(1/2)
65^(1/2)*(5^(1/2) + 5)^(1/2)
65^(1/2)*(5 - 5^(1/2))^(1/2)
5^(1/2)*(65 - 1345^(1/2))^(1/2)
```

Now, compute singular values of the matrix whose elements are symbolic expressions:

```
syms t real
A = [0 1; -1 0];
E = expm(t*A)
sigma = svd(E)
```

```
E =
[ cos(t), sin(t)]
[ -sin(t), cos(t)]
```

```
sigma =
(cos(t)^2 + sin(t)^2)^(1/2)
(cos(t)^2 + sin(t)^2)^(1/2)
```

Simplify the result:

```
sigma = simplify(sigma)
```

```
sigma =
1
1
```

For further computations, remove the assumption on t by recreating it using `syms`:

```
syms t
```

Floating-Point Singular Values

Convert the elements of the symbolic 5-by-5 magic square to floating-point numbers, and compute the singular values of the matrix:

```
A = sym(magic(5));
sigma = svd(vpa(A))
```

```
sigma =

                65.0
22.547088685879657984674226396467
21.687425355202639411956035427154
13.403565997991492328585154445703
11.900789544861194527298509087321
```

Singular Values and Singular Vectors

Compute the singular values and singular vectors of the 5-by-5 magic square:

```
old = digits(10);
A = sym(magic(5))
[U, S, V] = svd(A)
digits(old)
```

```
A =
```

```
[ 17, 24, 1, 8, 15]
[ 23, 5, 7, 14, 16]
[ 4, 6, 13, 20, 22]
[ 10, 12, 19, 21, 3]
[ 11, 18, 25, 2, 9]
```

```
U =
```

```
[ 0.4472135955, 0.5456348731, 0.5116672736, -0.1954395076, -0.4497583632]
[ 0.4472135955, 0.4497583632, -0.1954395076, 0.5116672736, 0.5456348731]
[ 0.4472135955, 2.420694008e-15, -0.632455532, -0.632455532, 1.29906993e-15]
```

```
[ 0.4472135955, -0.4497583632, -0.1954395076, 0.5116672736, -0.5456348731]
[ 0.4472135955, -0.5456348731, 0.5116672736, -0.1954395076, 0.4497583632]
```

S =

```
[ 65.0, 0, 0, 0, 0]
[ 0, 22.54708869, 0, 0, 0]
[ 0, 0, 21.68742536, 0, 0]
[ 0, 0, 0, 13.403566, 0]
[ 0, 0, 0, 0, 11.90078954]
```

V =

```
[ 0.4472135955, 0.4045164361, 0.2465648962, 0.6627260007, 0.3692782866]
[ 0.4472135955, 0.005566159714, 0.6627260007, -0.2465648962, -0.5476942741]
[ 0.4472135955, -0.8201651916, -3.091014288e-15, 6.350407543e-16, 0.3568319751]
[ 0.4472135955, 0.005566159714, -0.6627260007, 0.2465648962, -0.5476942741]
[ 0.4472135955, 0.4045164361, -0.2465648962, -0.6627260007, 0.3692782866]
```

Compute the product of U, S, and the Hermitian transpose of V with the 10-digit accuracy. The result is the original matrix A with all its elements converted to floating-point numbers:

```
vpa(U*S*V',10)
```

ans =

```
[ 17.0, 24.0, 1.0, 8.0, 15.0]
[ 23.0, 5.0, 7.0, 14.0, 16.0]
[ 4.0, 6.0, 13.0, 20.0, 22.0]
[ 10.0, 12.0, 19.0, 21.0, 3.0]
[ 11.0, 18.0, 25.0, 2.0, 9.0]
```

Thin or Economy SVD

Use the second input argument θ to compute the thin, or economy, SVD of this 3-by-2 matrix:

```
old = digits(10);
A = sym([1 1;2 2; 2 2]);
[U, S, V] = svd(A,  $\theta$ )
```

```
U =
[ 0.3333333333, -0.6666666667]
[ 0.6666666667, 0.6666666667]
[ 0.6666666667, -0.3333333333]
```

```
S =
[ 4.242640687, 0]
[ 0, 0]
```

```
V =
[ 0.7071067812, 0.7071067812]
[ 0.7071067812, -0.7071067812]
```

Now, use the second input argument 'econ' to compute the thin, or economy, of matrix B. Here, the 3-by-2 matrix B is the transpose of A.

```

B = A';
[U, S, V] = svd(B, 'econ')
digits(old)

U =
[ 0.7071067812, -0.7071067812]
[ 0.7071067812,  0.7071067812]

S =
[ 4.242640687, 0]
[           0, 0]

V =
[ 0.3333333333,  0.6666666667]
[ 0.6666666667, -0.6666666667]
[ 0.6666666667,  0.3333333333]

```

Input Arguments

A — Input matrix

symbolic matrix

Input matrix specified as a symbolic matrix. For syntaxes with one output argument, the elements of A can be symbolic numbers, variables, expressions, or functions. For syntaxes with three output arguments, the elements of A must be convertible to floating-point numbers.

Output Arguments

sigma — Singular values

symbolic vector | vector of symbolic numbers

Singular values of a matrix, returned as a vector. If **sigma** is a vector of numbers, then its elements are sorted in descending order.

U — Singular vectors

matrix of symbolic numbers

Singular vectors, returned as a unitary matrix. Each column of this matrix is a singular vector.

S — Singular values

matrix of symbolic numbers

Singular values, returned as a diagonal matrix. Diagonal elements of this matrix appear in descending order.

V — Singular vectors

matrix of symbolic numbers

Singular vectors, returned as a unitary matrix. Each column of this matrix is a singular vector.

Tips

- The second arguments `0` and `'econ'` only affect the shape of the returned matrices. These arguments do not affect the performance of the computations.

- Calling `svd` for numeric matrices that are not symbolic objects invokes the MATLAB `svd` function.
- Matrix computations involving many symbolic variables can be slow. To increase the computational speed, reduce the number of symbolic variables by substituting the given values for some variables.

See Also

`chol` | `digits` | `eig` | `inv` | `lu` | `qr` | `svd` | `vpa`

Topics

“Singular Value Decomposition” on page 2-151

Introduced before R2006a

sym

Create symbolic variables, expressions, functions, matrices

Note `sym('pi')` now creates a symbolic variable named `pi` instead of a symbolic number representing the mathematical constant π . For more information, see “Compatibility Considerations”.

Support of character vectors that are not valid variable names and that do not define a number has been removed. To create symbolic expressions, first create symbolic variables, and then use operations on them. For example, use `syms x; x + 1` instead of `sym('x + 1')`, `exp(sym(pi))` instead of `sym('exp(pi)')`, and `syms f(var1,...varN)` instead of `f(var1,...varN) = sym('f(var1,...varN)')`.

Syntax

```
x = sym('x')
A = sym('a',[n1 ... nM])
A = sym('a',n)
```

```
sym( ____,set)
sym( ____, 'clear')
```

```
sym(num)
sym(num,flag)
sym(strnum)
```

```
symexpr = sym(h)
```

Description

`x = sym('x')` creates symbolic variable `x`.

`A = sym('a',[n1 ... nM])` creates an `n1`-by-...-by-`nM` symbolic array filled with automatically generated elements. For example, `A = sym('a',[1 3])` creates the row vector `A = [a1 a2 a3]`. The generated elements `a1`, `a2`, and `a3` do not appear in the MATLAB workspace. For multidimensional arrays, these elements have the prefix `a` followed by the element's index using `_` as a delimiter, such as `a1_3_2`.

`A = sym('a',n)` creates an `n`-by-`n` symbolic matrix filled with automatically generated elements.

`sym(____,set)` creates a symbolic variable or array and sets the assumption that the variable or all array elements belong to a `set`. Here, `set` can be `'real'`, `'positive'`, `'integer'`, or `'rational'`. You also can combine multiple assumptions by specifying a string array or cell array of character vectors. For example, assume a positive rational value by specifying `set` as `["positive" "rational"]` or `{'positive','rational'}`.

`sym(____, 'clear')` clears assumptions set on a symbolic variable or array. You can specify `'clear'` after the input arguments in any of the previous syntaxes, except combining `'clear'` and `set`. You cannot set and clear an assumption in the same function call to `sym`.

`sym(num)` converts a number or numeric matrix specified by `num` to a symbolic number or symbolic matrix.

`sym(num, flag)` uses the technique specified by `flag` for converting floating-point numbers to symbolic numbers.

`sym(strnum)` converts the character vector or string specified by `strnum` to an accurate symbolic number that avoid any approximation.

`symexpr = sym(h)` creates a symbolic expression or matrix `symexpr` from an anonymous MATLAB function associated with the function handle `h`.

Examples

Create Symbolic Variables

Create the symbolic variables `x` and `y`.

```
x = sym('x')
```

```
x = x
```

```
y = sym('y')
```

```
y = y
```

Create Symbolic Vector

Create a 1-by-4 symbolic vector `a` with automatically generated elements `a1`, ..., `a4`.

```
a = sym('a', [1 4])
```

```
a =
```

```
[ a1, a2, a3, a4]
```

Format the names of elements of `a` by using a format character vector as the first argument. `sym` replaces `%d` in the format character vector with the index of the element to generate the element names.

```
a = sym('x_%d', [1 4])
```

```
a =
```

```
[ x_1, x_2, x_3, x_4]
```

This syntax does not create symbolic variables `x_1`, ..., `x_4` in the MATLAB workspace. Access elements of `a` using standard indexing methods.

```
a(1)
a(2:3)
```

```
ans =
```

```
x_1
```

```
ans =
```

```
[ x_2, x_3]
```

Create Symbolic Matrices

Create a 3-by-4 symbolic matrix with automatically generated elements. The elements are of the form $A_{i,j}$, which generates the elements $A_{1,1}$, ..., $A_{3,4}$.

```
A = sym('A',[3 4])
```

```
A =
```

```
[ A1_1, A1_2, A1_3, A1_4]
 [ A2_1, A2_2, A2_3, A2_4]
 [ A3_1, A3_2, A3_3, A3_4]
```

Create a 4-by-4 matrix with the element names $x_{1,1}$, ..., $x_{4,4}$ by using a format character vector as the first argument. `sym` replaces `%d` in the format character vector with the index of the element to generate the element names.

```
B = sym('x_%d_%d',4)
```

```
B =
```

```
[ x_1_1, x_1_2, x_1_3, x_1_4]
 [ x_2_1, x_2_2, x_2_3, x_2_4]
 [ x_3_1, x_3_2, x_3_3, x_3_4]
 [ x_4_1, x_4_2, x_4_3, x_4_4]
```

This syntax does not create symbolic variables $A_{1,1}$, ..., $A_{3,4}$, $x_{1,1}$, ..., $x_{4,4}$ in the MATLAB workspace. To access an element of a matrix, use parentheses.

```
A(2,3)
B(4,2)
```

```
ans =
```

```
A2_3
```

```
ans =
```

x_4_2

Create Symbolic Multidimensional Arrays

Create a 2-by-2-by-2 symbolic array with automatically generated elements $a_{1,1,1}, \dots, a_{2,2,2}$.

```
A = sym('a',[2 2 2])
```

```
A(:,:,1) =  
    ( a1,1,1 a1,2,1 )  
    ( a2,1,1 a2,2,1 )
```

```
A(:,:,2) =  
    ( a1,1,2 a1,2,2 )  
    ( a2,1,2 a2,2,2 )
```

Create Symbolic Numbers

Convert numeric values to symbolic numbers or expressions. Use `sym` on subexpressions instead of the entire expression for better accuracy. Using `sym` on entire expressions is inaccurate because MATLAB first converts the expression to a floating-point number, which loses accuracy. `sym` cannot always recover this lost accuracy.

```
inaccurate1 = sym(1/1234567)
```

```
inaccurate1 =  
    7650239286923505  
    9444732965739290427392
```

```
accurate1 = 1/sym(1234567)
```

```
accurate1 =  
    1  
    1234567
```

```
inaccurate2 = sym(sqrt(1234567))
```

```
inaccurate2 =  
    4886716562018589  
    4398046511104
```

```
accurate2 = sqrt(sym(1234567))
```

```
accurate2 =  $\sqrt{1234567}$ 
```

```
inaccurate3 = sym(exp(pi))
```

```
inaccurate3 =  
    6513525919879993  
    281474976710656
```

```
accurate3 = exp(sym(pi))
```

```
accurate3 = e $\pi$ 
```

Create Large Symbolic Numbers

When creating symbolic numbers with 15 or more digits, use quotation marks to accurately represent the numbers.

```
inaccurateNum = sym(1111111111111111111)
inaccurateNum = 11111111111111110656
accurateNum = sym('11111111111111111')
accurateNum = 11111111111111111
```

When you use quotation marks to create symbolic complex numbers, specify the imaginary part of a number as `1i`, `2i`, and so on.

```
sym('1234567 + 1i')
ans = 1234567 + i
```

Create Symbolic Expressions from Function Handles

Create a symbolic expression and a symbolic matrix from anonymous functions associated with MATLAB handles.

```
h_expr = @(x)(sin(x) + cos(x));
sym_expr = sym(h_expr)

sym_expr = cos(x) + sin(x)

h_matrix = @(x)(x*pascal(3));
sym_matrix = sym(h_matrix)

sym_matrix =

$$\begin{pmatrix} x & x & x \\ x & 2x & 3x \\ x & 3x & 6x \end{pmatrix}$$

```

Set Assumptions While Creating Variables

Create the symbolic variables `x`, `y`, `z`, and `t` while simultaneously assuming that `x` is real, `y` is positive, `z` rational, and `t` is positive integer.

```
x = sym('x', 'real');
y = sym('y', 'positive');
z = sym('z', 'rational');
t = sym('t', {'positive', 'integer'});
```

Check the assumptions on `x`, `y`, `z`, and `t` using `assumptions`.

```
assumptions
```

```
ans = (x ∈ ℝ z ∈ ℚ 1 ≤ t 0 < y t ∈ ℤ)
```

For further computations, clear the assumptions using `assume`.

```
assume([x y z t], 'clear')  
assumptions
```

```
ans =
```

```
Empty sym: 1-by-0
```

Set Assumptions on Matrix Elements

Create a symbolic matrix and set assumptions on each element of that matrix.

```
A = sym('A%d%d', [2 2], 'positive')
```

```
A =  

$$\begin{pmatrix} A_{11} & A_{12} \\ A_{21} & A_{22} \end{pmatrix}$$

```

Solve an equation involving the first element of A. MATLAB assumes that this element is positive.

```
solve(A(1,1)^2-1, A(1,1))
```

```
ans = 1
```

Check the assumptions set on the elements of A by using `assumptions`.

```
assumptions(A)
```

```
ans = (0 < A11 0 < A12 0 < A21 0 < A22)
```

Clear all previously set assumptions on elements of a symbolic matrix by using `assume`.

```
assume(A, 'clear');  
assumptions(A)
```

```
ans =
```

```
Empty sym: 1-by-0
```

Solve the same equation again.

```
solve(A(1,1)^2-1, A(1,1))
```

```
ans =  

$$\begin{pmatrix} -1 \\ 1 \end{pmatrix}$$

```

Choose Conversion Technique for Floating-Point Values

Convert `pi` to a symbolic value.

Choose the conversion technique by specifying the optional second argument, which can be `'r'`, `'f'`, `'d'`, or `'e'`. The default is `'r'`. See the Input Arguments section for the details about conversion techniques.

```
r = sym(pi)
```

```
r =  $\pi$ 
```

```
f = sym(pi, 'f')
```

```
f =
      884279719003555
     281474976710656
```

```
d = sym(pi, 'd')
```

```
d = 3.1415926535897931159979634685442
```

```
e = sym(pi, 'e')
```

```
e =
 $\pi - \frac{198 \text{ eps}}{359}$ 
```

Input Arguments

x — Variable name

character vector

Variable name, specified as a character vector. Argument `x` must be a valid variable name. That is, `x` must begin with a letter and can contain only alphanumeric characters and underscores. To verify that the name is a valid variable name, use `isvarname`.

Example: `x`, `y123`, `z_1`

h — Anonymous function

MATLAB function handle

Anonymous function, specified as a MATLAB function handle. For more information, see “Anonymous Functions” (MATLAB).

Example: `h = @(x)sin(x); symexpr = sym(h)`

a — Prefix for automatically generated matrix elements

character vector

Prefix for automatically generated matrix elements, specified as a character vector. Argument `a` must be a valid variable name. That is, `a` must begin with a letter and can contain only alphanumeric characters and underscores. To verify that the name is a valid variable name, use `isvarname`.

Example: `a`, `b`, `a_bc`

[n1 ... nM] – Vector, matrix, or array dimensions

vector of integers

Vector, matrix, or array dimensions, specified as a vector of integers. As a shortcut, you can create a square matrix by specifying only one integer. For example, `A = sym('A',3)` creates a square 3-by-3 matrix.

Example: `[2 3]`, `[2,3]`, `[2;3]`

set – Assumptions on symbolic variable or matrix

character vector | string array | cell array

Assumptions on symbolic variable or matrix, specified as a character vector, string array, or cell array. The available assumptions are 'integer', 'rational', 'real', or 'positive'.

You can combine multiple assumptions by specifying a string array or cell array of character vectors. For example, assume a positive rational value by specifying `set` as `["positive" "rational"]` or `{'positive','rational'}`.

Example: 'integer'

num – Numeric value to be converted to symbolic number or matrix

number | symbolic constant | matrix of numbers

Numeric value to be converted to symbolic number or matrix, specified as a number, symbolic constant, or a matrix of numbers.

Example: `10`, `pi`, `catalan`, `hilb(3)`

flag – Conversion technique

'r' (default) | 'd' | 'e' | 'f'

Conversion technique, specified as one of the characters listed in this table.

'r'	When <code>sym</code> uses the <i>rational</i> mode, it converts floating-point numbers obtained by evaluating expressions of the form p/q , $p*\pi/q$, \sqrt{p} , 2^q , and 10^q (for modest sized integers p and q) to the corresponding symbolic form. For example, <code>sym(1/10, 'r')</code> returns $1/10$. This effectively compensates for the round-off error involved in the original evaluation, but might not represent the floating-point value precisely. If <code>sym</code> cannot find simple rational approximation, then it uses the same technique as it would use with the flag 'f'.
'd'	When <code>sym</code> uses the <i>decimal</i> mode, it takes the number of digits from the current setting of <code>digits</code> . Conversions with fewer than 16 digits lose some accuracy, while more than 16 digits might not be warranted. For example, <code>sym(4/3, 'd')</code> with the 10-digit accuracy returns 1.333333333 , while with the 20-digit accuracy it returns 1.3333333333333332593 . The latter does not end in 3s, but it is an accurate decimal representation of the floating-point number nearest to $4/3$.
'e'	When <code>sym</code> uses the <i>estimate error</i> mode, it supplements a result obtained in the rational mode by a term involving the variable <code>eps</code> . This term estimates the difference between the theoretical rational expression and its actual floating-point value. For example, <code>sym(3*pi/4, 'e')</code> returns $(3*\pi)/4 - (103*\text{eps})/249$.

'f'	When <code>sym</code> uses the <i>floating-point to rational</i> mode, it returns the symbolic form for all values in the form $N*2^e$ or $-N*2^e$, where $N \geq 0$ and e are integers. The returned symbolic number is a precise rational number that is equal to the floating-point value. For example, <code>sym(1/10, 'f')</code> returns <code>3602879701896397/36028797018963968</code> .
-----	---

strnum — Characters representing symbolic number

character vector | string

Characters representing symbolic number, specified as a character vector or string.

Example: `'1/10'`, `'12/34'`

Output Arguments

x — Variable

symbolic variable

Variable, returned as a symbolic variable.

A — Vector or matrix with automatically generated elements

symbolic vector | symbolic matrix

Vector or matrix with automatically generated elements, returned as a symbolic vector or matrix. The elements of this vector or matrix do not appear in the MATLAB workspace.

symexpr — Expression or matrix generated from anonymous MATLAB function

symbolic expression | symbolic matrix

Expression or matrix generated from an anonymous MATLAB function, returned as a symbolic expression or matrix.

Tips

- Statements like `pi = sym(pi)` and `delta = sym('1/10')` create symbolic numbers that avoid the floating-point approximations inherent in the values of `pi` and `1/10`. The `pi` created in this way stores the symbolic number in a workspace variable named `pi`, which temporarily replaces the built-in numeric function with the same name. Use `clear pi` to restore the floating-point representation of `pi`.
- `sym` always treats `i` in character vector input as an identifier. To input the imaginary number `i`, use `1i` instead.
- `clear x` does not clear the symbolic object of its assumptions, such as `real`, `positive`, or any assumptions set by `assume`, `sym`, or `syms`. To remove assumptions, use one of these options:
 - `assume(x, 'clear')` removes all assumptions affecting `x`.
 - `clear all` clears all objects in the MATLAB workspace and resets the symbolic engine.
 - `assume` and `assumeAlso` provide more flexibility for setting assumptions on variable.
- When you replace one or more elements of a numeric vector or matrix with a symbolic number, MATLAB converts that number to a double-precision number.

```
A = eye(3);
A(1,1) = sym(pi)
```

```
A =
    3.1416         0         0
         0    1.0000         0
         0         0    1.0000
```

You cannot replace elements of a numeric vector or matrix with a symbolic variable, expression, or function because these elements cannot be converted to double-precision numbers. For example, `A(1,1) = sym('a')` throws an error.

- When you use the syntax `A = sym('a',[n1 ... nM])`, the `sym` function assigns only the symbolic array `A` to the MATLAB workspace. To also assign the automatically generated elements of `A`, use the `syms` function instead. For example, `syms a [1 3]` creates the row vector `a = [a1 a2 a3]` and the symbolic variables `a1`, `a2`, and `a3` in the MATLAB workspace.

Alternative Functionality

Alternative Approaches for Creating Symbolic Variables

To create several symbolic variables in one function call, use `syms`. Using `syms` also clears assumptions from the named variables.

Compatibility Considerations

`sym('pi')` creates symbolic variable

Behavior changed in R2020a

`sym('pi')` now creates a symbolic variable named `pi` instead of a symbolic number representing the mathematical constant π . In previous releases, both `sym('pi')` and `sym(pi)` create symbolic numbers representing the constant π .

For example, the command `a = sym('pi')` creates a symbolic variable named `pi` and assigns it to the workspace variable `a`.

```
a = sym('pi')
class(a)
symType(a)
vpa(2*a)

a =
pi

ans =
'sym'

ans =
"variable"

ans =
2.0*pi
```

To create a symbolic number representing the constant π , use `a = sym(pi)` instead.

```
a = sym(pi)
class(a)
symType(a)
vpa(2*a)
```

```
a =  
pi  
  
ans =  
    'sym'  
  
ans =  
    "constant"  
  
ans =  
6.283185307179586476925286766559
```

This behavior also applies to the mathematical constants `catalan` and `eulergamma`.

Support of character vectors has been removed

Errors starting in R2018a

Support of character vectors that are not valid variable names and that do not define a number has been removed. To create symbolic expressions, first create symbolic variables, and then use operations on them. For example, use `syms x; x + 1` instead of `sym('x + 1')`, `exp(sym(pi))` instead of `sym('exp(pi)')`, and `syms f(var1,...varN)` instead of `f(var1,...varN) = sym('f(var1,...varN)')`.

See Also

`assume` | `double` | `reset` | `str2sym` | `symfun` | `syms` | `symvar`

Topics

“Create Symbolic Numbers, Variables, and Expressions” on page 1-3

“Create Symbolic Functions” on page 1-7

“Create Symbolic Matrices” on page 1-9

“Choose `syms` or `sym` Function” on page 2-5

“Use Assumptions on Symbolic Variables” on page 1-24

“Add Subscripts, Superscripts, and Accents to Symbolic Variables” on page 2-8

Introduced before R2006a

sym2cell

Convert symbolic array to cell array

Syntax

```
C = sym2cell(S)
```

Description

`C = sym2cell(S)` converts a symbolic array `S` to a cell array `C`. The resulting cell array has the same size and dimensions as the input symbolic array.

Examples

Convert Symbolic Array to Cell Array

Convert a matrix of symbolic variables and numbers to a cell array.

Create the following symbolic matrix.

```
syms x y
S = [x 2 3 4; y 6 7 8; 9 10 11 12]
```

```
S =
[ x, 2, 3, 4]
[ y, 6, 7, 8]
[ 9, 10, 11, 12]
```

Convert this matrix to a cell array by using `sym2cell`. The size of the resulting cell array corresponds to the size of the input matrix. Each cell contains an element of the symbolic matrix `S`.

```
C = sym2cell(S)
```

```
C =
3x4 cell array
    {1x1 sym}    {1x1 sym}    {1x1 sym}    {1x1 sym}
    {1x1 sym}    {1x1 sym}    {1x1 sym}    {1x1 sym}
    {1x1 sym}    {1x1 sym}    {1x1 sym}    {1x1 sym}
```

To access an element in each cell, use curly braces.

```
[C{1,1:4}]
```

```
ans =
[ x, 2, 3, 4]
```

```
[C{1:3,1}]
```

```
ans =
[ x, y, 9]
```

Input Arguments

S — Input symbolic array

symbolic number | symbolic variable | symbolic expression | symbolic function | symbolic vector | symbolic matrix | symbolic multidimensional array

Input symbolic array, specified as a symbolic vector, matrix, or multidimensional array. S also can be a scalar, that is, a symbolic number, variable, expression, or function.

Output Arguments

C — Resulting cell array

cell array

Resulting cell array, returned as a cell array such that `size(C) = size(S)`. Each element of the input symbolic array S is enclosed in a separate cell.

See Also

`cell2mat` | `cell2sym` | `mat2cell` | `num2cell`

Introduced in R2016a

sym2poly

Extract vector of all numeric coefficients, including zeros, from symbolic polynomial

Syntax

```
c = sym2poly(p)
```

Description

`c = sym2poly(p)` returns the numeric vector of coefficients `c` of the symbolic polynomial `p`. The returned vector `c` includes all coefficients, including those equal 0.

`sym2poly` returns coefficients in order of descending powers of the polynomial variable. If $c_1x^{n-1} + c_2x^{n-2} + \dots + c_n$, then `c = sym2poly(p)` returns `c = [c1 c2 ... cn]`.

Examples

Extract Numeric Coefficients of Polynomial

Create row vectors of coefficients of symbolic polynomials.

Extract integer coefficients of a symbolic polynomial into a numeric row vector.

```
syms x
c = sym2poly(x^3 - 2*x - 5)
```

```
c =
     1     0    -2    -5
```

Extract rational and integer coefficients of a symbolic polynomial into a vector. Because `sym2poly` returns numeric double-precision results, it approximates exact rational coefficients with double-precision numbers.

```
c = sym2poly(1/2*x^3 - 2/3*x - 5)
```

```
c =
 0.5000         0 -0.6667 -5.0000
```

Input Arguments

p — Polynomial

symbolic expression

Polynomial, specified as a symbolic expression.

Output Arguments

c — Polynomial coefficients

numeric row vector

Polynomial coefficients, returned as a numeric row vector.

Tips

- To extract symbolic coefficients of a polynomial, use `coeffs`. This function returns a symbolic vector of coefficients and omits all zeros. For example, `syms a b x; c = coeffs(a*x^3 - 5*b,x)` returns `c = [-5*b, a]`.

See Also

`coeffs` | `poly2sym`

Introduced before R2006a

symengine

(Not recommended) Return symbolic engine

Note is not recommended. Use equivalent Symbolic Math Toolbox™ functions that replace MuPAD® functions instead. For more information, see “Compatibility Considerations”.

Syntax

```
s = symengine
```

Description

`s = symengine` returns the currently active symbolic engine.

Examples

Return Active Symbolic Engine

To see which symbolic computation engine is currently active, enter:

```
s = symengine
```

```
s =  
MuPAD symbolic engine
```

Now you can use the variable `s` in function calls that require symbolic engine:

```
syms a b c x  
p = a*x^2 + b*x + c;  
feval(s,'polylib::discrim', p, x)
```

```
ans =  
b^2 - 4*a*c
```

Compatibility Considerations

symengine is not recommended

Not recommended starting in R2018b

Symbolic Math Toolbox includes operations and functions for symbolic math expressions that parallel MATLAB functionality for numeric values. Unlike MuPAD functionality, Symbolic Math Toolbox functions enable you to work in familiar interfaces, such as the MATLAB Command Window or Live Editor, which offer a smooth workflow and are optimized for usability.

Therefore, instead of passing a symbolic engine and MuPAD expressions to `feval`, `evalin`, and `read`, use the equivalent Symbolic Math Toolbox functionality to work with symbolic math expressions. For a list of available functions, see Symbolic Math Toolbox functions list.

To convert a MuPAD notebook file to a MATLAB live script file, see `convertMuPADNotebook`.

If you cannot find the Symbolic Math Toolbox equivalent for MuPAD functionality, contact MathWorks Technical Support.

Although the use of `symengine` is not recommended, there are no plans to remove it at this time.

Introduced in R2008b

symfalse

Symbolic logical constant false

Syntax

```
F = symfalse
```

Description

F = `symfalse` returns the symbolic logical constant for the false condition.

Examples

Simplify Symbolic Inequality

Create a symbolic inequality $x^2 > 4$.

```
syms x
eq = x^2 > 4
```

```
eq = 4 < x^2
```

Assume that $-2 < x < 2$.

```
assume(-2 < x & x < 2)
```

Simplify the condition represented by the symbolic inequality `eq`. The `simplify` function returns the symbolic logical constant `symfalse` since the condition never holds for the assumption $-2 < x < 2$.

```
F = simplify(eq)
```

```
F = symfalse
```

Display the data type of `symfalse`, which is `sym`.

```
class(F)
```

```
ans =
'sym'
```

You can also use `isAlways` to check if the inequality does not hold under the assumption being made. In this example, `isAlways` returns logical 0 (false).

```
TF = isAlways(eq)
```

```
TF = logical
    0
```

Create Truth Table for Logical Operation

Create a truth table for the and operation applied to the two symbolic logical constants, `symtrue` and `symfalse`.

```
A = [symtrue symfalse]
```

```
A = (symtrue symfalse)
```

```
B = [symtrue; symfalse]
```

```
B =
     (symtrue)
     (symfalse)
```

```
TF = and(A,B)
```

```
TF =
     (symtrue symfalse)
     (symfalse symfalse)
```

Combine Symbolic Logical Constants

Combine symbolic logical constants with logical operators and, not, or, and xor (or their shortcuts).

```
TF = xor(symtrue,or(symfalse,symfalse))
```

```
TF = symtrue
```

```
TF = symtrue & ~(symfalse)
```

```
TF = symtrue
```

Convert symfalse to Other Data Types

Convert the symbolic logical constant `symfalse` to a logical value.

```
T1 = logical(symfalse)
```

```
T1 = logical
      0
```

Convert the symbolic logical constant `symfalse` to numeric values in double precision and variable precision.

```
T2 = double(symfalse)
```

```
T2 = 0
```

```
T3 = vpa(symfalse)
```

```
T3 = 0.0
```

Show the data types of T1, T2, and T3.

whos

Name	Size	Bytes	Class	Attributes
T1	1x1	1	logical	
T2	1x1	8	double	
T3	1x1	8	sym	

Output Arguments

F — Symbolic logical constant for false condition

scalar

Symbolic logical constant for false condition, returned as a scalar.

Data Types: sym

Tips

- The command `sym(false)` returns a symbolic number 0 , and `sym(symfalse)` returns `symfalse`.
- When you combine two arrays of symbolic logical constants with logical operations using `and`, `or`, or `xor` function, the arrays must either be the same size or have sizes that are compatible. For more information on the required input sizes for basic array operations, see “Compatible Array Sizes for Basic Operations” (MATLAB).

See Also

`and` | `isAlways` | `not` | `or` | `symtrue` | `xor`

Introduced in R2020a

symfun

Create symbolic functions

Syntax

```
f(inputs) = formula
f = symfun(formula,inputs)
```

Description

`f(inputs) = formula` creates the symbolic function `f`. For example, `f(x,y) = x + y`. The symbolic variables in `inputs` are the input arguments. The symbolic expression `formula` is the body of the function `f`.

`f = symfun(formula,inputs)` is the formal way to create a symbolic function.

Examples

Create and Define Symbolic Functions

Define the symbolic function `x + y`. First, create the function by using `syms`. Then define the function.

```
syms f(x,y)
f(x,y) = x + y
```

```
f(x, y) =
x + y
```

Find the value of `f` at `x = 1` and `y = 2`.

```
f(1,2)
```

```
ans =
3
```

Define the function again by using the formal way.

```
syms x y
f = symfun(x+y,[x y])
```

```
f(x, y) =
x + y
```

Return Body and Arguments of Symbolic Function

Return the body of a symbolic function by using `formula`. You can use the body for operations such as indexing into the function. Return the arguments of a symbolic function by using `argnames`.

Index into the symbolic function `[x^2, y^4]`. Since a symbolic function is a scalar, you cannot directly index into the function. Instead, index into the body of the function.

```
syms f(x,y)
f(x,y) = [x^2, y^4];

fbody = formula(f);
fbody(1)
fbody(2)

ans =
x^2
ans =
y^4
```

Return the arguments of the function.

```
fvars = argnames(f)

fvars =
[ x, y]
```

Input Arguments

formula — Function body

symbolic expression | vector of symbolic expressions | matrix of symbolic expressions

Function body, specified as a symbolic expression, vector of symbolic expressions, or matrix of symbolic expressions.

Example: $x + y$

inputs — Input argument or arguments of function

symbolic variable | array of symbolic variables

Input argument or arguments of a function, specified as a symbolic variable or an array of symbolic variables, respectively.

Example: $[x, y]$

Output Arguments

f — Function

symbolic function (symfun data type)

Function, returned as a symbolic function (symfun data type).

See Also

[argnames](#) | [formula](#) | [matlabFunction](#) | [sym](#) | [syms](#) | [symvar](#)

Topics

“Create Symbolic Functions” on page 1-7

Introduced in R2012a

symFunType

Determine functional type of symbolic object

Syntax

```
s = symFunType(symObj)
```

Description

`s = symFunType(symObj)` returns the functional type of a symbolic object.

- If `symObj` is a symbolic function or a symbolic expression, then `symFunType` returns the topmost function name or operator of `symObj`. For example, `syms x; symFunType(2*sin(x))` returns "times".
- If `symObj` is not a symbolic function or a symbolic expression, then `symFunType` returns the same output as `symType`. For example, `symFunType(sym('2'))` returns "integer".

Examples

Symbolic Function or Expression

Create an array of symbolic functions and expressions.

```
syms f(x)
expr = [f(x) sin(x) exp(x) int(f(x)) diff(f(x))]
```

```
expr =
    (f(x) sin(x) e^x ∫ f(x)dx ∂/∂x f(x))
```

Determine the functional type of each array element.

```
s = symFunType(expr)

s = 1x5 string
    "f"      "sin"      "exp"      "int"      "diff"
```

Topmost Arithmetic Operators of Symbolic Expressions

Create two symbolic expressions. Determine the topmost arithmetic operators of the expressions.

```
syms x
expr1 = x/(x^2+x+2);
expr2 = x + 1/(x^2+x+2);
s1 = symFunType(expr1)
```

```
s1 =
    "times"
```

```
s2 = symFunType(expr2)
```

```
s2 =  
"plus"
```

To return the terms separated by the operators, use `children`.

```
terms1 = children(expr1)
```

```
terms1 =  
 $\left(x \frac{1}{x^2 + x + 2}\right)$ 
```

```
terms2 = children(expr2)
```

```
terms2 =  
 $\left(x \frac{1}{x^2 + x + 2}\right)$ 
```

Comparison Operators in Equations and Inequalities

Create an array of symbolic equations and inequalities.

```
syms x y  
eqns = [x+y==2, x<=5, y>3]
```

```
eqns = (x + y = 2 x ≤ 5 3 < y)
```

Determine the topmost comparison operator in each array element.

```
s = symFunType(eqns)
```

```
s = 1x3 string  
"eq" "le" "lt"
```

Input Arguments

symObj — Symbolic objects

symbolic expressions | symbolic functions | symbolic variables | symbolic numbers | symbolic units

Symbolic objects, specified as symbolic expressions, symbolic functions, symbolic variables, symbolic numbers, or symbolic units.

Output Arguments

s — Symbolic functional types

string array

Symbolic functional types, returned as a string array. If `symObj` is a symbolic function or a symbolic expression, then `symFunType` returns the topmost function name or operator of `symObj`. This table shows output values for various symbolic objects.

Symbolic Functional Types	Returned Output	Input Example
symbolic math functions	"sin", "exp", "fourier", and so on — name of the topmost symbolic math function in a symbolic expression	<code>syms f(x); symFunType([sin(x), exp(x), fourier(x)])</code>
unassigned symbolic functions	"f", "g", and so on — unassigned symbolic function	<code>syms f(x) g(x); symFunType([f, g(x+2)])</code>
arithmetic operators	<ul style="list-style-type: none"> • "plus" — addition operator + and subtraction operator - • "times" — multiplication operator * and division operator / • "power" — power or exponentiation operator ^ and square root operator sqrt 	<ul style="list-style-type: none"> • <code>syms x; symFunType(x^2-x)</code> • <code>syms x; symFunType(2*x^2)</code> • <code>syms x; symFunType([x^2 sqrt(x)])</code>
equations and inequalities	<ul style="list-style-type: none"> • "eq" — equality operator == • "ne" — inequality operator ~= • "lt" — less-than operator < or greater-than operator > • "le" — less-than-or-equal-to operator <= or greater-than-or-equal-to operator >= 	<ul style="list-style-type: none"> • <code>syms x y; symFunType(x==y)</code> • <code>syms x y; symFunType(x~=y)</code> • <code>syms x y; symFunType(x<y)</code> • <code>syms x y; symFunType(x>=y)</code>
logical operators	<ul style="list-style-type: none"> • "or" — logical OR operator • "and" — logical AND operator & • "not" — logical NOT operator ~ • "xor" — logical exclusive-OR operator xor 	<ul style="list-style-type: none"> • <code>syms x y; symFunType(x y)</code> • <code>syms x y; symFunType(x&y)</code> • <code>syms x; symFunType(~x)</code> • <code>syms x y; symFunType(xor(x,y))</code>
numbers	<ul style="list-style-type: none"> • "integer" — integer number • "rational" — rational number • "vpereal" — variable-precision floating-point real number • "complex" — complex number 	<ul style="list-style-type: none"> • <code>symFunType(sym('-1'))</code> • <code>symFunType(sym('1/2'))</code> • <code>symFunType([sym('1.5') vpa('3/2')])</code> • <code>symFunType(sym('1+2i'))</code>
constants	"constant"	<code>symFunType(sym([pi catalan]))</code>
variables	"variable"	<code>symFunType(sym(x))</code>
units	"units"	<code>symFunType(symunit('m'))</code>
unsupported symbolic types	"unsupported"	

See Also

hasSymType | isSymType | sym | symType | symfun | syms

Introduced in R2019a

sympref

Set symbolic preferences

Syntax

```
oldVal = sympref(pref,value)
```

```
oldVal = sympref(pref)
```

```
oldPrefs = sympref(prefs)
```

```
oldPrefs = sympref()
```

Description

`oldVal = sympref(pref,value)` sets the symbolic preference `pref` to `value` and returns the previous value of the preference to `oldVal`. You can set the preference to its default value using `sympref(pref,'default')`.

Symbolic preferences can affect the computation of the symbolic functions `fourier`, `ifourier`, and `heaviside`, and the display format of symbolic output.

`oldVal = sympref(pref)` returns the current value of `pref`.

`oldPrefs = sympref(prefs)` sets multiple symbolic preferences to the values in the structure `prefs` and returns the previous values of all preferences to `oldPrefs`. You can set all symbolic preferences to their default values using `sympref('default')`.

`oldPrefs = sympref()` returns the current values of all symbolic preferences.

Note Symbolic preferences persist through successive MATLAB sessions. Opening a new session does not restore the default preferences.

Examples

Change Parameter Values of Fourier Transform

The Fourier transform $F(w)$ of $f = f(t)$ is

$$F(w) = c \int_{-\infty}^{\infty} f(t)e^{iswt} dt,$$

where c and s are parameters with the default values 1 and -1, respectively. Other common values for c are $1/2\pi$ and $1/\sqrt{2\pi}$, and other common values for s are 1, -2π , and 2π .

Find the Fourier transform of $\sin(t)$ with default c and s parameters.

```
syms t w
F = fourier(sin(t),t,w)
```

```
F =
-pi*(dirac(w - 1) - dirac(w + 1))*1i
```

Find the same Fourier transform with $c = 1/(2\pi)$ and $s = 1$. Set the parameter values by using the 'FourierParameters' preference. Represent π exactly by using `sym`. Specify the values of `c` and `s` as the vector `[1/(2*sym(pi)) 1]`. Store the previous values returned by `sympref` so that you can restore them later.

```
oldVal = sympref('FourierParameters',[1/(2*sym(pi)) 1])
F = fourier(sin(t),t,w)
```

```
oldVal =
[ 1, -1]
```

```
F =
(dirac(w - 1)*1i)/2 - (dirac(w + 1)*1i)/2
```

The preferences you set using `sympref` persist through your current and future MATLAB sessions. Restore the previous values of `c` and `s` to `oldVal`.

```
sympref('FourierParameters',oldVal);
```

Alternatively, you can restore the default values of `c` and `s` by specifying the 'default' option.

```
sympref('FourierParameters','default');
```

Change Value of Heaviside Function at Origin

In Symbolic Math Toolbox, the default value of the Heaviside function at the origin is $1/2$. Return the value of `heaviside(0)`. Find the Z-transform of `heaviside(x)` for this default value of `heaviside(0)`.

```
syms x
H = heaviside(sym(0))
Z = ztrans(heaviside(x))
```

```
H =
1/2
```

```
Z =
1/(z - 1) + 1/2
```

Other common values for the Heaviside function at the origin are 0 and 1. Set `heaviside(0)` to 1 using the 'HeavisideAtOrigin' preference. Store the previous value returned by `sympref` so that you can restore it later.

```
oldVal = sympref('HeavisideAtOrigin',1)
```

```
oldVal =
1/2
```

Check if the new value of `heaviside(0)` is 1. Find the Z-transform of `heaviside(x)` for this value.

```
H = heaviside(sym(0))
Z = ztrans(heaviside(x))
```

```
H =
1
```

```
Z =
1/(z - 1) + 1
```

The new output of `heaviside(0)` modifies the output of `ztrans`.

The preferences you set using `sympref` persist through your current and future MATLAB sessions. Restore the previous value of `heaviside(0)` to `oldVal`.

```
sympref('HeavisideAtOrigin',oldVal);
```

Alternatively, you can restore the default value of `'HeavisideAtOrigin'` by specifying the `'default'` option.

```
sympref('HeavisideAtOrigin','default');
```

Modify Display of Symbolic Expressions in Live Scripts

By default, symbolic expressions in live scripts are displayed in abbreviated output format, and typeset in mathematical notation. You can turn off abbreviated output format and typesetting using symbolic preferences.

Create a symbolic expression and return the output, which is abbreviated by default.

```
syms a b c d x
f = a*x^3 + b*x^2 + c*x + d;
outputAbbrev = sin(f) + cos(f) + tan(f) + log(f) + 1/f
outputAbbrev =
cos(σ1) + log(σ1) + sin(σ1) + tan(σ1) +  $\frac{1}{\sigma_1}$ 
```

where

$$\sigma_1 = ax^3 + bx^2 + cx + d$$

Turn off abbreviated output format by setting the `'AbbreviateOutput'` preference to `false`. Redisplay the expression.

```
sympref('AbbreviateOutput',false);
outputLong = sin(f) + cos(f) + tan(f) + log(f) + 1/f
outputLong =
cos(ax3 + bx2 + cx + d) + log(ax3 + bx2 + cx + d) + sin(ax3 + bx2 + cx + d) + tan(ax3 + bx2 + cx + d)
+  $\frac{1}{ax^3 + bx^2 + cx + d}$ 
```

Create another symbolic expression and return the output, which is typeset in mathematical notation by default. Turn off rendered output and use ASCII output instead by setting the `'TypesetOutput'` preference to `false`. First, show the typeset output.

```
syms a b c d x
f = exp(a^b)+pi
f =  $\pi + e^{a^b}$ 
```

Turn off typesetting by setting the 'TypesetOutput' preference to false. Redisplay the expression.

```
sympref('TypesetOutput',false);
f = exp(a^b)+pi
```

f =

pi + exp(a^b)

The preferences you set using `sympref` persist through your current and future MATLAB sessions. Restore the default values of 'AbbreviateOutput' and 'TypesetOutput' by specifying the 'default' option.

```
sympref('AbbreviateOutput','default');
sympref('TypesetOutput','default');
```

Display Symbolic Results in Floating-Point Format

Display symbolic results in floating-point output format, that is the short, fixed-decimal format with 4 digits after the decimal point.

Create a quadratic equation.

```
syms x
eq = x^2 - 2e3/sym(pi)*x + 0.5 == 0
```

eq =

$$x^2 - \frac{2000x}{\pi} + \frac{1}{2} = 0$$

Find the solutions of the equation using `solve`.

```
sols = solve(eq,x)
```

sols =

$$\left(\begin{array}{c} -\frac{\sqrt{2}\sqrt{2000000 - \pi^2} - 2000}{2\pi} \\ \frac{\sqrt{2}\sqrt{2000000 - \pi^2} + 2000}{2\pi} \end{array} \right)$$

Set the 'FloatingPointOutput' preference to true. Display the quadratic equation and its solutions in floating-point format.

```
sympref('FloatingPointOutput',true);
eq
```

eq = $x^2 - 636.6198x + 0.5000 = 0$

sols

sols =

$$\begin{pmatrix} 7.8540e-04 \\ 636.6190 \end{pmatrix}$$

The floating-point format displays each symbolic number in the short, fixed-decimal format with 4 digits after the decimal point. Setting the 'FloatingPointOutput' preference does not affect the floating-point precision in a symbolic computation. To compute symbolic numbers using floating-point arithmetic, use the `vpa` function.

Now restore the default value of 'FloatingPointOutput' by specifying the 'default' option. Compute the floating-point approximation of the solutions in 8 significant digits using `vpa`.

```
sympref('FloatingPointOutput','default');
sols = vpa(sols,8)

sols =
    (0.00078539913)
    ( 636.61899 )
```

Modify Output Order of Symbolic Polynomial

Create a symbolic polynomial expression consisting of multiple variables. Display the polynomial in the default order.

```
syms x y a b
p1 = b^2*x^2 + a^2*x + y^3 + 2

p1 = a^2 x + b^2 x^2 + y^3 + 2
```

The default option sorts the output in alphabetical order, without distinguishing the different symbolic variables in each monomial term.

Now display the same polynomial in ascending order by setting the preference 'PolynomialDisplayStyle' to 'ascend'.

```
sympref('PolynomialDisplayStyle','ascend');
p1

p1 = 2 + y^3 + a^2 x + b^2 x^2
```

The 'ascend' option sorts the output in ascending order based on the importance of the variables. Here, the most important variable `x` with the highest order in a monomial term is displayed last.

Display the polynomial in descending order by setting the 'PolynomialDisplayStyle' preference to 'descend'.

```
sympref('PolynomialDisplayStyle','descend');
p1

p1 = b^2 x^2 + a^2 x + y^3 + 2
```

The preferences you set using `sympref` persist through your current and future MATLAB sessions. Restore the default value of 'PolynomialDisplayStyle' by specifying the 'default' option.

```
sympref('PolynomialDisplayStyle','default');
```

Modify Display of Symbolic Matrix in Live Scripts

By default, a symbolic matrix in live scripts is set in parentheses (round brackets). You can specify the use of square brackets instead by using `sympref`.

Create a symbolic matrix consisting of symbolic variables and numbers.

```
syms x y
A = [x*y, 2; 4, y^2]
```

```
A =
    (
      x y 2
    4 y^2
    )
```

Display the matrix with square brackets by setting the `'MatrixWithSquareBrackets'` preference to `true`.

```
sympref('MatrixWithSquareBrackets',true);
A
```

```
A =
    [
      x y 2
    4 y^2
    ]
```

The preferences you set using `sympref` persist through your current and future MATLAB sessions. Restore the default value by specifying the `'default'` option.

```
sympref('MatrixWithSquareBrackets','default');
```

Save and Restore All Symbolic Preferences

Instead of saving and restoring individual preferences one by one, you can use `sympref` to save and restore all symbolic preferences simultaneously.

Return a structure containing the values of all symbolic preferences by using `sympref()`.

```
oldPrefs = sympref()

oldPrefs =

    struct with fields:

        FourierParameters: [1x2 sym]
        HeavisideAtOrigin: [1x1 sym]
        AbbreviateOutput: 1
        TypesetOutput: 1
        FloatingPointOutput: 0
        PolynomialDisplayStyle: 'default'
        MatrixWithSquareBrackets: 0
```

Access the value of each symbolic preference by addressing the field of the structure. Alternatively, you can use the command `sympref(pref)`.

```
val1 = oldPrefs.FourierParameters
val2 = oldPrefs.HeavisideAtOrigin
val3 = sympref('FourierParameters')
```

```
val1 =
[ 1, -1]
```

```
val2 =
1/2
```

```
val3 =
[ 1, -1]
```

To modify multiple symbolic preferences simultaneously, you can create a structure `prefs` that contains the preference values. Use the command `sympref(prefs)` to set multiple preferences.

```
prefs.FourierParameters = [1/(2*sym(pi) 1]
prefs.HeavisideAtOrigin = 1
sympref(prefs);
```

Because symbolic preferences persist through your current and future MATLAB sessions, you need to restore your previous preferences. Restore the saved preferences using `sympref(oldPrefs)`.

```
sympref(oldPrefs);
```

Alternatively, you can set all symbolic preferences to their default values by specifying the `'default'` option.

```
sympref('default');
```

Input Arguments

pref — Symbolic preference

character vector | string

Symbolic preference, specified as a character vector or string. The value options for each symbolic preference follow.

Preference	Value	Description
'FourierParameters' s'	Two-element row vector $[c, s]$. The parameters c and s must be numeric or symbolic numbers. Default: <code>sym([1, -1])</code> .	Set the values of the parameters c and s in the Fourier transform: $F(w) = c \int_{-\infty}^{\infty} f(t)e^{iswt} dt.$ See "Change Parameter Values of Fourier Transform" on page 4-1319.
'HeavisideAtOrigin'	Scalar value, specified as a numeric or symbolic number. Default: <code>sym(1/2)</code> .	Set the value of the Heaviside function <code>heaviside(0)</code> at the origin. See "Change Value of Heaviside Function at Origin" on page 4-1320.

Preference	Value	Description
'AbbreviateOutput'	Logical value (boolean). Default: logical 1 (true).	Specify whether or not to use abbreviated output format of symbolic variables and expressions in Live Scripts. See “Modify Display of Symbolic Expressions in Live Scripts” on page 4-1321.
'TypesetOutput'	Logical value (boolean). Default: logical 1 (true).	Typeset or use ASCII characters for the output of symbolic variables and expressions in Live Scripts. See “Modify Display of Symbolic Expressions in Live Scripts” on page 4-1321.
'FloatingPointOutput'	Logical value (boolean). Default: logical 0 (false).	Specify whether or not to display symbolic results in floating-point output format. The true value option displays symbolic results in the short fixed-decimal format with 4 digits after the decimal point. See “Display Symbolic Results in Floating-Point Format” on page 4-1322.
'PolynomialDisplayStyle'	Character vector or scalar string, specified as 'default', 'ascend', or 'descend'. Default: 'default'.	Display a symbolic polynomial in default, ascending, or descending order. <ul style="list-style-type: none"> The 'default' option sorts the output in alphabetical order, without distinguishing the different symbolic variables in each monomial term. The 'ascend' option sorts the output in ascending order based on the standard mathematical notation for polynomials. For example, the variable x with the highest order in a monomial term is displayed last, preceded by monomial terms that contain the variables y, z, t, s, and so on. The 'descend' option sorts the output in descending order based on the standard mathematical notation for polynomials. This option is the exact opposite of 'ascend'. See “Modify Output Order of Symbolic Polynomial” on page 4-1323.
'MatrixWithSquareBrackets'	Logical value (boolean). Default: logical 0 (false).	Set matrices in round brackets or parentheses (round brackets) in Live Scripts. See “Modify Display of Symbolic Matrix in Live Scripts” on page 4-1324.

value — Value of symbolic preference

'default' (default) | valid value

Value of symbolic preference, specified as 'default' or a valid value of the specified preference pref.

prefs — Symbolic preferences

structure array

Symbolic preferences, specified as a structure array. You can set multiple preferences by declaring the field names and the valid preference values.

Output Arguments

oldVal — Value of symbolic preference

valid value

Value of symbolic preference, returned as a valid value. `oldVal` represents the existing value of the preference `pref` before the call to `sympref`.

oldPrefs — All symbolic preferences

structure array

All symbolic preferences, returned as a structure array. `oldPrefs` represent the existing values of all preferences before the call to `sympref`.

Tips

- The `clear` command does *not* reset or affect symbolic preferences. Use `sympref` to manipulate symbolic preferences.
- The symbolic preferences you set using `sympref` also determine the output generated by the `latex` and `mathml` functions.
- Setting the 'FloatingPointOutput' preference affects only the output display format of symbolic numbers. To change the output display format of numeric numbers, use the `format` function. To compute symbolic numbers using floating-point precision, use the `vpa` or `digits` functions.

See Also

`digits` | `fourier` | `heaviside` | `ifourier` | `latex` | `mathml` | `taylor` | `vpa`

Topics

"Change Output Display Format of Symbolic Results" on page 2-12

Introduced in R2015a

symprod

Product of series

Syntax

```
F = symprod(f,k,a,b)
F = symprod(f,k)
```

Description

`F = symprod(f,k,a,b)` returns the product of the series with terms that expression `f` specifies, which depend on symbolic variable `k`. The value of `k` ranges from `a` to `b`. If you do not specify `k`, `symprod` uses the variable that `symvar` determines. If `f` is a constant, then the default variable is `x`.

`F = symprod(f,k)` returns the product of the series that expression `f` specifies, which depend on symbolic variable `k`. The value of `k` starts at 1 with an unspecified upper bound. The product `F` is returned in terms of `k` where `k` represents the upper bound. This product `F` differs from the indefinite product. If you do not specify `k`, `symprod` uses the variable that `symvar` determines. If `f` is a constant, then the default variable is `x`.

Examples

Find Product of Series Specifying Bounds

Find the following products of series

$$P1 = \prod_{k=2}^{\infty} 1 - \frac{1}{k^2},$$

$$P2 = \prod_{k=2}^{\infty} \frac{k^2}{k^2 - 1}.$$

```
syms k
P1 = symprod(1 - 1/k^2, k, 2, Inf)
P2 = symprod(k^2/(k^2 - 1), k, 2, Inf)
```

```
P1 =
1/2
P2 =
2
```

Alternatively, specify bounds as a row or column vector.

```
syms k
P1 = symprod(1 - 1/k^2, k, [2 Inf])
P2 = symprod(k^2/(k^2 - 1), k, [2; Inf])
```

```
P1 =
1/2
P2 =
2
```

Find Product of Series Specifying Product Index and Bounds

Find the product of series

$$P = \prod_{k=1}^{10000} \frac{e^{kx}}{x}.$$

```
syms k x
P = symprod(exp(k*x)/x, k, 1, 10000)

P =
exp(50005000*x)/x^10000
```

Find Product of Series with Unspecified Bounds

When you do not specify the bounds of a series are unspecified, the variable k starts at 1. In the returned expression, k itself represents the upper bound.

Find the products of series with an unspecified upper bound

$$P1 = \prod_k k,$$

$$P2 = \prod_k \frac{2k-1}{k^2}.$$

```
syms k
P1 = symprod(k, k)
P2 = symprod((2*k - 1)/k^2, k)

P1 =
factorial(k)
P2 =
(1/2^(2*k)*2^(k + 1)*factorial(2*k))/(2*factorial(k)^3)
```

Input Arguments

f — Expression defining terms of series

symbolic expression | symbolic function | symbolic vector | symbolic matrix | symbolic number

Expression defining terms of series, specified as a symbolic expression, function, constant, or a vector or matrix of symbolic expressions, functions, or constants.

k — Product index

symbolic variable

Product index, specified as a symbolic variable. If you do not specify this variable, `symprod` uses the default variable that `symvar(expr, 1)` determines. If f is a constant, then the default variable is x .

a — Lower bound of product index

number | symbolic number | symbolic variable | symbolic expression | symbolic function

Lower bound of product index, specified as a number, symbolic number, variable, expression, or function (including expressions and functions with infinities).

b — Upper bound of product index

number | symbolic number | symbolic variable | symbolic expression | symbolic function

Upper bound of product index, specified as a number, symbolic number, variable, expression, or function (including expressions and functions with infinities).

More About

Definite Product

The definite product of a series is defined as

$$\prod_{i=a}^b x_i = x_a \cdot x_{a+1} \cdot \dots \cdot x_b$$

Indefinite Product

The indefinite product of x_i over i is

$$f(i) = \prod_i x_i$$

This definition holds under the assumption that the following identity is true for all values of i .

$$\frac{f(i+1)}{f(i)} = x_i$$

Note `symprod` does not compute indefinite products.

See Also

`cumprod` | `cumsum` | `int` | `syms` | `symsum` | `symvar`

Introduced in R2011b

symReadSSCParameters

Load parameters from Simscape component

Syntax

```
[names,values,units] = symReadSSCParameters(componentName)
```

Description

[names,values,units] = symReadSSCParameters(componentName) returns cell arrays containing the names, values, and units of all parameters from the Simscape component called componentName.

Examples

Parameters of Simscape Component

Load the names, values, and units of the parameters of a Simscape component.

Suppose you have the Simscape component `friction.ssc` in your current folder.

```
type('friction.ssc');

component friction < foundation.mechanical.rotational.branch

parameters
    brkwy_trq = { 25, 'N*m' };           % Breakaway friction torque
    Col_trq = { 20, 'N*m' };           % Coulomb friction torque
    visc_coef = { 0.001, 'N*m*s/rad' }; % Viscous friction coefficient
    trans_coef = { 10, 's/rad' };      % Transition approximation coefficient
    vel_thr = { 1e-4, 'rad/s' };       % Linear region velocity threshold
end

parameters (Access=private)
    brkwy_trq_th = { 24.995, 'N*m' };   % Breakaway torque at threshold velocity
end

function setup
    % Parameter range checking
    if brkwy_trq <= 0
        pm_error('simscape:GreaterThanZero','Breakaway friction torque' )
    end
    if Col_trq <= 0
        pm_error('simscape:GreaterThanZero','Coulomb friction torque' )
    end
    if Col_trq > brkwy_trq
        pm_error('simscape:LessThanOrEqual','Coulomb friction torque',...
            'Breakaway friction torque')
    end
    if visc_coef < 0
        pm_error('simscape:GreaterThanOrEqualToZero','Viscous friction coefficient')
```

```

end
if trans_coef <= 0
    pm_error('simscape:GreaterThanZero','Transition approximation coefficient')
end
if vel_thr <= 0
    pm_error('simscape:GreaterThanZero','Linear region velocity threshold')
end

% Computing breakaway torque at threshold velocity
brkwy_trq_th = visc_coef * vel_thr + Col_trq + (brkwy_trq - Col_trq) * ...
    exp(-trans_coef * vel_thr);
end

equations
    if (abs(w) <= vel_thr)
        % Linear region
        t == brkwy_trq_th * w / vel_thr;
    elseif w > 0
        t == visc_coef * w + Col_trq + ...
            (brkwy_trq - Col_trq) * exp(-trans_coef * w);
    else
        t == visc_coef * w - Col_trq - ...
            (brkwy_trq - Col_trq) * exp(-trans_coef * abs(w));
    end
end
end
end

```

Load the names, values, and units of the parameters of the component `friction.ssc`.

```
[names,values,units] = symReadSSCParameters('friction.ssc');
```

In this example, all elements of the resulting cell arrays are scalars. You can convert the cell arrays to symbolic vectors.

```
names_sym = cell2sym(names)
```

```
names_sym =
[ Col_trq, brkwy_trq, brkwy_trq_th, trans_coef, vel_thr, visc_coef]
```

```
values_sym = cell2sym(values)
```

```
values_sym =
[ 20, 25, 4999/200, 10, 1/10000, 1/1000]
```

Create individual symbolic variables from the elements of the cell array `names` in the MATLAB workspace. This command creates the symbolic variables `Col_trq`, `brkwy_trq`, `brkwy_trq_th`, `trans_coef`, `vel_thr`, and `visc_coef` as `sym` objects in the workspace.

```
syms(names)
```

Input Arguments

componentName — Simscape component name

file name enclosed in single quotes

Simscape component name, specified as a file name enclosed in single quotes. The file must have the extension `.ssc`. If you do not provide the file extension, `symReadSSCParameters` assumes it to be `.ssc`. The component must be on the MATLAB path or in the current folder.

Example: `'MyComponent.ssc'`

Output Arguments

names — Names of all parameters of Simscape component

cell array

Names of all parameters of a Simscape component, returned as a cell array.

Data Types: `cell`

values — Values of all parameters of Simscape component

cell array

Values of all parameters of a Simscape component, returned as a cell array.

Data Types: `cell`

units — Units of all parameters of Simscape component

cell array

Units of all parameters of a Simscape component, returned as a cell array.

Data Types: `cell`

See Also

`symReadSSCVariables` | `symWriteSSC`

Introduced in R2016a

symReadSSCVariables

Load variables from Simscape component

Syntax

```
[names,values,units] = symReadSSCVariables(componentName)
[names,values,units] = symReadSSCVariables(
componentName,'ReturnFunctions',true)
```

Description

[names,values,units] = symReadSSCVariables(componentName) returns cell arrays containing the names, values, and units of all variables from the Simscape component called componentName.

[names,values,units] = symReadSSCVariables(componentName,'ReturnFunctions',true) returns the names as symbolic functions of variable t.

Examples

Variables of Simscape Component

Load the names, values, and units of the variables of a Simscape component.

Suppose you have the Simscape component `friction.ssc` in your current folder.

```
type('friction.ssc');

component friction < foundation.mechanical.rotational.branch

parameters
    brkwy_trq = { 25, 'N*m' };           % Breakaway friction torque
    Col_trq = { 20, 'N*m' };           % Coulomb friction torque
    visc_coef = { 0.001, 'N*m*s/rad' }; % Viscous friction coefficient
    trans_coef = { 10, 's/rad' };      % Transition approximation coefficient
    vel_thr = { 1e-4, 'rad/s' };       % Linear region velocity threshold
end

parameters (Access=private)
    brkwy_trq_th = { 24.995, 'N*m' };   % Breakaway torque at threshold velocity
end

function setup
    % Parameter range checking
    if brkwy_trq <= 0
        pm_error('simscape:GreaterThanZero','Breakaway friction torque' )
    end
    if Col_trq <= 0
        pm_error('simscape:GreaterThanZero','Coulomb friction torque' )
    end
end
```

```

if Col_trq > brkwy_trq
    pm_error('simscape:LessThanOrEqual','Coulomb friction torque',...
            'Breakaway friction torque')
end
if visc_coef < 0
    pm_error('simscape:GreaterThanOrEqualToZero','Viscous friction coefficient')
end
if trans_coef <= 0
    pm_error('simscape:GreaterThanZero','Transition approximation coefficient')
end
if vel_thr <= 0
    pm_error('simscape:GreaterThanZero','Linear region velocity threshold')
end

% Computing breakaway torque at threshold velocity
brkwy_trq_th = visc_coef * vel_thr + Col_trq + (brkwy_trq - Col_trq) * ...
    exp(-trans_coef * vel_thr);
end

equations
if (abs(w) <= vel_thr)
    % Linear region
    t == brkwy_trq_th * w / vel_thr;
elseif w > 0
    t == visc_coef * w + Col_trq + ...
        (brkwy_trq - Col_trq) * exp(-trans_coef * w);
else
    t == visc_coef * w - Col_trq - ...
        (brkwy_trq - Col_trq) * exp(-trans_coef * abs(w));
end
end
end

```

Load the names, values, and units of the variables of the component `friction.ssc`.

```
[names,values,units] = symReadSSCVariables('friction.ssc');
```

In this example, all elements of the resulting cell arrays are scalars. You can convert the cell arrays to symbolic vectors.

```
names_sym = cell2sym(names)
```

```
names_sym =
[ t, w]
```

```
values_sym = cell2sym(values)
```

```
values_sym =
[ 0, 0]
```

Create individual symbolic variables from the elements of the cell array `names` in the MATLAB workspace. This command creates the symbolic variables `t` and `w` as `sym` objects in the workspace.

```
syms(names)
```

Variables of Simscape Component Returned as Functions

Load the names of the variables of a Simscape component while converting them to symbolic functions of the variable `t`.

Suppose you have the Simscape component `source.ssc` in your current folder.

```
type('source.ssc');

component source
% Electrical Source
% Defines an electrical source with positive and negative external nodes.
% Also defines associated through and across variables.

nodes
    p = foundation.electrical.electrical; % :top
    n = foundation.electrical.electrical; % :bottom
end

variables(Access=protected)
    i = { 0, 'A' }; % Current
    v = { 0, 'V' }; % Voltage
end

branches
    i : p.i -> n.i;
end

equations
    v == p.v - n.v;
end

end
```

Load the names of the variables of the component `source.ssc` by setting `'ReturnFunctions'` to `true`.

```
[names,~,~] = symReadSSCVariables('source.ssc','ReturnFunctions',true);
```

In this example, all elements of the resulting cell arrays are scalars. You can convert the cell arrays to symbolic vectors.

```
names_symfun = cell2sym(names)

names_symfun =
[ i(t), v(t)]
```

Create individual symbolic functions from the elements of the cell array `names` in the MATLAB workspace. This command creates the symbolic functions `i` and `v` as `symfun` objects, and their variable `t` as a `sym` object in the workspace.

```
syms(names)
```

Input Arguments

componentName — Simscape component name
file name enclosed in single quotes

Simscape component name, specified as a file name enclosed in single quotes. The file must have the extension `.ssc`. If you do not provide the file extension, `symReadSSCVariables` assumes it to be `.ssc`. The component must be on the MATLAB path or in the current folder.

Example: `'MyComponent.ssc'`

Output Arguments

names — Names of all variables of Simscape component

cell array

Names of all variables of a Simscape component, returned as a cell array.

Data Types: `cell`

values — Values of all variables of Simscape component

cell array

Values of all variables of a Simscape component, returned as a cell array.

Data Types: `cell`

units — Units of all variables of Simscape component

cell array

Units of all variables of a Simscape component, returned as a cell array.

Data Types: `cell`

See Also

`symReadSSCParameters` | `symWriteSSC`

Introduced in R2016a

syms

Create symbolic variables and functions

Syntax

```
syms var1 ... varN
syms var1 ... varN [n1 ... nM]
syms var1 ... varN n
syms ___ set

syms f(var1,...,varN)
syms f(var1,...,varN) [n1 ... nM]
syms f(var1,...,varN) n

syms(symArray)

syms
S = syms
```

Description

`syms var1 ... varN` creates symbolic variables `var1 ... varN`. Separate different variables by spaces. `syms` clears all assumptions from the variables.

`syms var1 ... varN [n1 ... nM]` creates symbolic arrays `var1 ... varN`, where each array has the size `n1-by-...-by-nM` and contains automatically generated symbolic variables as its elements. For example, `syms a [1 3]` creates the symbolic array `a = [a1 a2 a3]` and the symbolic variables `a1`, `a2`, and `a3` in the MATLAB workspace. For multidimensional arrays, these elements have the prefix `a` followed by the element's index using `_` as a delimiter, such as `a1_3_2`.

`syms var1 ... varN n` creates `n-by-n` symbolic matrices filled with automatically generated elements.

`syms ___ set` sets the assumption that the created symbolic variables belong to `set`, and clears other assumptions. Here, `set` can be `real`, `positive`, `integer`, or `rational`. You also can combine multiple assumptions using spaces. For example, `syms x positive rational` creates a variable `x` with a positive rational value.

`syms f(var1,...,varN)` creates the symbolic function `f` and the symbolic variables `var1, ..., varN`, which represent the input arguments of `f`. You can create multiple symbolic functions in one call. For example, `syms f(x) g(t)` creates two symbolic functions (`f` and `g`) and two symbolic variables (`x` and `t`).

`syms f(var1,...,varN) [n1 ... nM]` creates an `n1-by-...-by-nM` symbolic array with automatically generated symbolic functions as its elements. This syntax also generates the symbolic variables `var1, ..., varN` that represent the input arguments of `f`. For example, `syms f(x) [1 2]` creates the symbolic array `f(x) = [f1(x) f2(x)]`, the symbolic functions `f1(x)` and `f2(x)`, and the symbolic variable `x` in the MATLAB workspace. For multidimensional arrays, these elements have the prefix `f` followed by the element's index using `_` as a delimiter, such as `f1_3_2`.

`syms f(var1,...,varN) n` creates an n-by-n symbolic matrix filled with automatically generated elements.

`syms(symArray)` creates the symbolic variables and functions contained in `symArray`, where `symArray` is either a vector of symbolic variables or a cell array of symbolic variables and functions. Use this syntax only when such an array is returned by another function, such as `solve` or `symReadSSCVariables`.

`syms` lists the names of all symbolic variables, functions, and arrays in the MATLAB workspace.

`S = syms` returns a cell array of the names of all symbolic variables, functions, and arrays.

Examples

Create Symbolic Variables

Create symbolic variables `x` and `y`.

```
syms x y
x
x = x
y
y = y
```

Create Symbolic Vectors

Create a 1-by-4 symbolic vector `a` with the automatically generated elements a_1, \dots, a_4 . This command also creates the symbolic variables `a1, ..., a4` in the MATLAB workspace.

```
syms a [1 4]
a
a = (a1 a2 a3 a4)
```

`whos`

Name	Size	Bytes	Class	Attributes
a	1x4	8	sym	
a1	1x1	8	sym	
a2	1x1	8	sym	
a3	1x1	8	sym	
a4	1x1	8	sym	

You can change the naming format of the generated elements by using a format character vector. Declare the symbolic variables by enclosing each variable name in single quotes. `syms` replaces `%d` in the format character vector with the index of the element to generate the element names.

```
syms 'p_a%d' 'p_b%d' [1 4]
p_a
```

```
p_a = (p_a1 p_a2 p_a3 p_a4)
```

```
p_b
```

```
p_b = (p_b1 p_b2 p_b3 p_b4)
```

Create Symbolic Matrices

Create a 3-by-4 symbolic matrix with automatically generated elements. The elements are of the form $A_{i,j}$, which generates the elements $A_{1,1}, \dots, A_{3,4}$.

```
syms A [3 4]
```

```
A
```

```
A =
```

$$\begin{pmatrix} A_{1,1} & A_{1,2} & A_{1,3} & A_{1,4} \\ A_{2,1} & A_{2,2} & A_{2,3} & A_{2,4} \\ A_{3,1} & A_{3,2} & A_{3,3} & A_{3,4} \end{pmatrix}$$

Set Assumptions While Creating Variables

Create symbolic variables x and y , and assume that they are integers.

```
syms x y integer
```

Create another variable z , and assume that it has a positive rational value.

```
syms z positive rational
```

Check assumptions.

```
assumptions
```

```
ans = (x ∈ ℤ y ∈ ℤ z ∈ ℚ 0 < z)
```

Alternatively, check assumptions on each variable. For example, check assumptions set on the variable x .

```
assumptions(x)
```

```
ans = x ∈ ℤ
```

Clear assumptions on x , y , and z .

```
assume([x y z], 'clear')
```

```
assumptions
```

```
ans =
```

```
Empty sym: 1-by-0
```

Create a 1-by-3 symbolic array `a` and assume that the array elements have real values.

```
syms a [1 3] real
assumptions
ans = (a1 ∈ ℝ a2 ∈ ℝ a3 ∈ ℝ)
```

Create Symbolic Functions

Create symbolic functions with one and two arguments.

```
syms s(t) f(x,y)
```

Both `s` and `f` are abstract symbolic functions. They do not have symbolic expressions assigned to them, so the bodies of these functions are `s(t)` and `f(x,y)`, respectively.

Specify the following formula for `f`.

```
f(x,y) = x + 2*y
f(x, y) = x + 2 y
```

Compute the function value at the point `x = 1` and `y = 2`.

```
f(1,2)
ans = 5
```

Create Symbolic Functions with Matrices as Formulas

Create a symbolic function and specify its formula by using a symbolic matrix.

```
syms x
M = [x x^3; x^2 x^4];
f(x) = M
```

```
f(x) =
    (
      x  x^3
      x^2 x^4
    )
```

Compute the function value at the point `x = 2`:

```
f(2)
ans =
    (
      2  8
      4 16
    )
```

Compute the value of this function for `x = [1 2 3; 4 5 6]`. The result is a cell array of symbolic matrices.

```
xVal = [1 2 3; 4 5 6];
y = f(xVal)
```

```
y=2x2 cell array
    {2x3 sym}    {2x3 sym}
    {2x3 sym}    {2x3 sym}
```

Access the contents of a cell in the cell array by using braces.

```
y{1}
```

```
ans =
    (1 2 3)
    (4 5 6)
```

Create Symbolic Matrices as Functions of Two Variables

Create a 2-by-2 symbolic matrix with automatically generated symbolic functions as its elements.

```
syms f(x,y) 2
f
```

```
f(x, y) =
    (f1,1(x,y) f1,2(x,y))
    (f2,1(x,y) f2,2(x,y))
```

Assign symbolic expressions to the symbolic functions $f_{1,1}(x, y)$ and $f_{2,2}(x, y)$. These functions are displayed as $f_{1,1}(x, y)$ and $f_{2,2}(x, y)$ in the Live Editor. When you assign these expressions, the symbolic matrix f still contains the initial symbolic functions in its elements.

```
f1_1(x,y) = 2*x;
f2_2(x,y) = x - y;
f
```

```
f(x, y) =
    (f1,1(x,y) f1,2(x,y))
    (f2,1(x,y) f2,2(x,y))
```

Substitute the expressions assigned to $f_{1,1}(x, y)$ and $f_{2,2}(x, y)$ by using the `subs` function.

```
A = subs(f)
```

```
A(x, y) =
    (2x f1,2(x,y))
    (f2,1(x,y) x-y)
```

Evaluate the value of the symbolic matrix A , which contains the substituted expressions at $x = 2$ and $y = 3$.

```
A(2,3)
```

```
ans =
    (4 f1,2(2,3))
    (f2,1(2,3) -1)
```

Create Symbolic Objects from Returned Symbolic Array

Certain functions, such as `solve` and `symReadSSCVariables`, can return a vector of symbolic variables or a cell array of symbolic variables and functions. These variables or functions do not automatically appear in the MATLAB workspace. Create these variables or functions from the vector or cell array by using `syms`.

Solve the equation $\sin(x) == 1$ by using `solve`. The parameter `k` in the solution does not appear in the MATLAB workspace.

```
syms x
eqn = sin(x) == 1;
[sol, parameter, condition] = solve(eqn, x, 'ReturnConditions', true);
parameter

parameter = k
```

Create the parameter `k` by using `syms`. The parameter `k` now appears in the MATLAB workspace.

```
syms(parameter)
```

Similarly, use `syms` to create the symbolic objects contained in a vector or cell array. Examples of functions that return a cell array of symbolic objects are `symReadSSCVariables` and `symReadSSCParameters`.

List All Symbolic Variables, Functions, and Arrays

Create some symbolic variables, functions, and arrays.

```
syms a f(x)
syms A [2 2]
```

Display a list of all symbolic objects that currently exist in the MATLAB workspace by using `syms`.

```
syms
```

```
Your symbolic variables are:
```

```
A      A1_1  A1_2  A2_1  A2_2  a      f      x
```

Instead of displaying a list, return a cell array of all symbolic objects by providing an output to `syms`.

```
S = syms
```

```
S = 8x1 cell
    {'A' }
    {'A1_1'}
    {'A1_2'}
    {'A2_1'}
    {'A2_2'}
    {'a' }
    {'f' }
    {'x' }
```

Delete All Symbolic Variables, Functions, or Arrays

Create several symbolic objects.

```
syms a b c f(x)
```

Return all symbolic objects as a cell array by using the `syms` function. Use the `cellfun` function to delete all symbolic objects in the cell array `symObj`.

```
symObj = syms;  
cellfun(@clear, symObj)
```

Check that you deleted all symbolic objects by calling `syms`. The output is empty, meaning no symbolic objects exist in the MATLAB workspace.

```
syms
```

Input Arguments

var1 ... varN — Symbolic variables, matrices, or arrays

valid variable names separated by spaces

Symbolic variables, matrices, or arrays, specified as valid variable names separated by spaces. Each variable name must begin with a letter and can contain only alphanumeric characters and underscores. To verify that the name is a valid variable name, use `isvarname`.

Example: `x y123 z_1`

[n1 ... nM] — Vector, matrix, or array dimensions

vector of integers

Vector, matrix, or array dimensions, specified as a vector of integers. As a shortcut, you can create a square matrix by specifying only one integer. For example, `syms x 3` creates a square 3-by-3 matrix.

Example: `[2 3]`, `[2,3]`, `[2;3]`

set — Assumptions on symbolic variables

`real` | `positive` | `integer` | `rational`

Assumptions on a symbolic variable or matrix, specified as `real`, `positive`, `integer`, or `rational`.

You can combine multiple assumptions using spaces. For example, `syms x positive rational` creates a variable `x` with a positive rational value.

Example: `rational`

f(var1, ..., varN) — Symbolic function with its input arguments

expression with parentheses

Symbolic function with its input arguments, specified as an expression with parentheses. The function name `f` and the variable names `var1 ... varN` must be valid variable names. That is, they must begin with a letter and can contain only alphanumeric characters and underscores. To verify that the name is a valid variable name, use `isvarname`.

Example: $s(t)$, $f(x, y)$

symArray — Symbolic variables and functions

vector of symbolic variables | cell array of symbolic variables and functions

Symbolic variables or functions, specified as a vector of symbolic variables or a cell array of symbolic variables and functions. Such a vector or array is typically the output of another function, such as `solve` or `symReadSSCVariables`.

Output Arguments

S — Names of all symbolic variables, functions, and arrays

cell array of character vectors

Names of all symbolic variables, functions, and arrays in the MATLAB workspace, returned as a cell array of character vectors.

Tips

- `syms` is a shortcut for `sym`. This shortcut lets you create several symbolic variables in one function call. Alternatively, you can use `sym` and create each variable separately. However, when you create variables using `sym`, any existing assumptions on the created variables are retained. You can also use `symfun` to create symbolic functions.
- In functions and scripts, do not use `syms` to create symbolic variables with the same names as MATLAB functions. For these names, MATLAB does not create symbolic variables, but keeps the names assigned to the functions. If you want to create a symbolic variable with the same name as a MATLAB function inside a function or a script, use `sym` instead. For example, use `alpha = sym('alpha')`.
- The following variable names are invalid with `syms`: `integer`, `real`, `rational`, `positive`, and `clear`. To create variables with these names, use `sym`. For example, `real = sym('real')`.
- `clear x` does not clear the symbolic object of its assumptions, such as `real`, `positive`, or any assumptions set by `assume`, `sym`, or `syms`. To remove assumptions, use one of these options:
 - `syms x` clears all assumptions from `x`.
 - `assume(x, 'clear')` clears all assumptions from `x`.
 - `clear all` clears all objects in the MATLAB workspace and resets the symbolic engine.
 - `assume` and `assumeAlso` provide more flexibility for setting assumptions on variables.
- When you replace one or more elements of a numeric vector or matrix with a symbolic number, MATLAB converts that number to a double-precision number.

```
A = eye(3);
A(1,1) = sym(pi)
```

```
A =
    3.1416         0         0
         0    1.0000         0
         0         0    1.0000
```

You cannot replace elements of a numeric vector or matrix with a symbolic variable, expression, or function because these elements cannot be converted to double-precision numbers. For example, `syms a; A(1,1) = a` throws an error.

Compatibility Considerations

syms clears assumptions

Behavior changed in R2018b

`syms` now clears any assumptions on the variables that it creates. For example,

```
syms x real
assume(x <= 5);
assumptions(x)
```

```
ans =
```

```
x <= 5
```

```
syms x
assumptions(x)
```

```
ans =
```

```
Empty sym: 1-by-0
```

To retain existing assumptions on a cleared variable, recreate it using `sym` instead of `syms`. For example,

```
syms x real
assume(x <= 5);
clear x
x = sym('x');
assumptions(x)
```

```
ans =
```

```
x <= 5
```

syms will no longer support clear option

Warns starting in R2018b

The syntaxes `syms x clear` and the equivalent `syms('x', 'clear')` now warn that they will be removed in a future release.

In previous releases, both syntaxes cleared all assumptions applied to `x`. To update your code, call `syms` and specify the variables whose assumptions you want to clear. For example, `syms x` clears all assumptions applied to `x`.

See Also

[assume](#) | [assumeAlso](#) | [assumptions](#) | [isvarname](#) | [reset](#) | [sym](#) | [symfun](#) | [symvar](#)

Topics

“Create Symbolic Numbers, Variables, and Expressions” on page 1-3

“Create Symbolic Functions” on page 1-7

“Create Symbolic Matrices” on page 1-9

“Choose `syms` or `sym` Function” on page 2-5

“Use Assumptions on Symbolic Variables” on page 1-24

“Add Subscripts, Superscripts, and Accents to Symbolic Variables” on page 2-8

Introduced before R2006a

symsum

Sum of series

Syntax

```
F = symsum(f,k,a,b)
F = symsum(f,k)
```

Description

`F = symsum(f,k,a,b)` returns the sum of the series `f` with respect to the summation index `k` from the lower bound `a` to the upper bound `b`. If you do not specify `k`, `symsum` uses the variable determined by `symvar` as the summation index. If `f` is a constant, then the default variable is `x`.

`symsum(f,k,[a b])` or `symsum(f,k,[a; b])` is equivalent to `symsum(f,k,a,b)`.

`F = symsum(f,k)` returns the indefinite sum (antidifference) of the series `f` with respect to the summation index `k`. The `f` argument defines the series such that the indefinite sum `F` satisfies the relation $F(k+1) - F(k) = f(k)$. If you do not specify `k`, `symsum` uses the variable determined by `symvar` as the summation index. If `f` is a constant, then the default variable is `x`.

Examples

Find Sum of Series with Bounds

Find the following sums of series.

$$F1 = \sum_{k=0}^{10} k^2$$

$$F2 = \sum_{k=1}^{\infty} \frac{1}{k^2}$$

$$F3 = \sum_{k=1}^{\infty} \frac{x^k}{k!}$$

```
syms k x
```

```
F1 = symsum(k^2,k,0,10)
```

```
F1 = 385
```

```
F2 = symsum(1/k^2,k,1,Inf)
```

```
F2 =
```

$$\frac{\pi^2}{6}$$

```
F3 = symsum(x^k/factorial(k),k,1,Inf)
```

```
F3 = e^x - 1
```

Alternatively, you can specify summation bounds as a row or column vector.

```
F1 = symsum(k^2,k,[0 10])
```

```
F1 = 385
```

```
F2 = symsum(1/k^2,k,[1;Inf])
```

```
F2 =
```

$$\frac{\pi^2}{6}$$

```
F3 = symsum(x^k/factorial(k),k,[1 Inf])
```

```
F3 = e^x - 1
```

Find Indefinite Sum of Series

Find the following indefinite sums of series (antidifferences).

$$F1 = \sum_k k$$

$$F2 = \sum_k 2^k$$

$$F3 = \sum_k \frac{1}{k^2}$$

```
syms k
```

```
F1 = symsum(k,k)
```

```
F1 =
```

$$\frac{k^2}{2} - \frac{k}{2}$$

```
F2 = symsum(2^k,k)
```

```
F2 = 2^k
```

```
F3 = symsum(1/k^2,k)
```

```
F3 =
```

$$\begin{cases} -\psi'(k) & \text{if } 0 < k \\ \psi'(1-k) & \text{if } k \leq 0 \end{cases}$$

Summation of Polynomial Series

Find the summation of the polynomial series $F(x) = \sum_{k=1}^8 a_k x^k$.

If you know that the coefficient a_k is a function of some integer variable k , use the `symsum` function.

For example, find the sum $F(x) = \sum_{k=1}^8 kx^k$.

```
syms x k
F(x) = symsum(k*x^k, k, 1, 8)
```

$$F(x) = 8x^8 + 7x^7 + 6x^6 + 5x^5 + 4x^4 + 3x^3 + 2x^2 + x$$

Calculate the summation series for $x = 2$.

```
F(2)
```

```
ans = 3586
```

Alternatively, if you know that the coefficients a_k are a vector of values, you can use the `sum` function. For example, the coefficients are $a_1, \dots, a_8 = 1, \dots, 8$. Declare the term x^k as a vector by using `subs(x^k, k, 1:8)`.

```
a = 1:8;
G(x) = sum(a.*subs(x^k, k, 1:8))
```

$$G(x) = 8x^8 + 7x^7 + 6x^6 + 5x^5 + 4x^4 + 3x^3 + 2x^2 + x$$

Calculate the summation series for $x = 2$.

```
G(2)
```

```
ans = 3586
```

Input Arguments

f — Expression defining terms of series

symbolic expression | symbolic function | symbolic vector | symbolic matrix | symbolic number

Expression defining terms of series, specified as a symbolic expression, function, vector, matrix, or symbolic number.

k — Summation index

symbolic variable

Summation index, specified as a symbolic variable. If you do not specify this variable, `symsum` uses the default variable determined by `symvar(expr, 1)`. If `f` is a constant, then the default variable is `x`.

a — Lower bound of summation index

number | symbolic number | symbolic variable | symbolic expression | symbolic function

Lower bound of the summation index, specified as a number, symbolic number, variable, expression, or function (including expressions and functions with infinities).

b — Upper bound of summation index

number | symbolic number | symbolic variable | symbolic expression | symbolic function

Upper bound of the summation index, specified as a number, symbolic number, variable, expression, or function (including expressions and functions with infinities).

More About

Definite Sum

The definite sum of a series is defined as

$$\sum_{k=a}^b x_k = x_a + x_{a+1} + \dots + x_b.$$

Indefinite Sum

The indefinite sum (antidifference) of a series is defined as

$$F(x) = \sum_x f(x),$$

such that

$$F(x+1) - F(x) = f(x).$$

See Also

cumsum | int | sum | symprod | syms | symvar

Topics

“Symbolic Summation” on page 2-65

Introduced before R2006a

symtrue

Symbolic logical constant true

Syntax

```
T = symtrue
```

Description

T = symtrue returns the symbolic logical constant for the true condition.

Examples

Simplify Symbolic Inequality

Create a symbolic inequality $x^2 > 4$.

```
syms x
eq = x^2 > 4
```

```
eq = 4 < x^2
```

Assume that $x > 2$.

```
assume(x>2)
```

Simplify the condition represented by the symbolic inequality eq. The simplify function returns the symbolic logical constant symtrue since the condition always holds for the assumption $x > 2$.

```
T = simplify(eq)
```

```
T = symtrue
```

Display the data type of symtrue, which is sym.

```
class(T)
```

```
ans =
'sym'
```

You can also use isAlways to check if the inequality holds under the assumption being made. In this example, isAlways returns logical 1 (true).

```
TF = isAlways(eq)
```

```
TF = logical
    1
```

Create Truth Table for Logical Operation

Create a truth table for the and operation applied to the two symbolic logical constants, `symtrue` and `symfalse`.

```
A = [symtrue symfalse]
```

```
A = (symtrue symfalse)
```

```
B = [symtrue; symfalse]
```

```
B =
     (symtrue)
     (symfalse)
```

```
TF = and(A,B)
```

```
TF =
     (symtrue symfalse)
     (symfalse symfalse)
```

Combine Symbolic Logical Constants

Combine symbolic logical constants with logical operators and, not, or, and xor (or their shortcuts).

```
TF = xor(symtrue,or(symfalse,symfalse))
```

```
TF = symtrue
```

```
TF = symtrue & ~(symfalse)
```

```
TF = symtrue
```

Convert `symtrue` to Other Data Types

Convert the symbolic logical constant `symtrue` to a logical value.

```
T1 = logical(symtrue)
```

```
T1 = logical
      1
```

Convert the symbolic logical constant `symtrue` to numeric values in double precision and variable precision.

```
T2 = double(symtrue)
```

```
T2 = 1
```

```
T3 = vpa(symtrue)
```

```
T3 = 1.0
```

Show the data types of T1, T2, and T3.

whos

Name	Size	Bytes	Class	Attributes
T1	1x1	1	logical	
T2	1x1	8	double	
T3	1x1	8	sym	

Output Arguments

T – Symbolic logical constant for true condition

scalar

Symbolic logical constant for true condition, returned as a scalar.

Data Types: sym

Tips

- The command `sym(true)` returns a symbolic number 1, and `sym(symtrue)` returns `symtrue`.
- When you combine two arrays of symbolic logical constants with logical operations using `and`, `or`, or `xor` function, the arrays must either be the same size or have sizes that are compatible. For more information on the required input sizes for basic array operations, see “Compatible Array Sizes for Basic Operations” (MATLAB).

See Also

`and` | `isAlways` | `not` | `or` | `symfalse` | `xor`

Introduced in R2020a

symType

Determine type of symbolic object

Syntax

```
s = symType(symObj)
```

Description

`s = symType(symObj)` returns the type of a symbolic object. For example, `symType(sym('x'))` returns "variable".

Examples

Symbolic Number

Create a symbolic number and determine its type.

```
a = sym('3/9');
s = symType(a)
```

```
s =
"rational"
```

Now construct a symbolic array by including symbolic numbers in the array elements. Determine the symbolic type of each array element.

```
B = [-5, a, vpa(a), 1i, pi];
s = symType(B)
```

```
s = 1x5 string
    "integer"    "rational"    "vpareal"    "complex"    "constant"
```

Symbolic Function or Expression

Create a symbolic function $f(x)$ using `syms`.

```
syms f(x)
```

Determine the type of the function. Because $f(x)$ is an unassigned symbolic function, it has the symbolic type "symfun".

```
s = symType(f)
```

```
s =
"symfun"
```

Assigning a mathematical expression to $f(x)$ changes its symbolic type.

```
f(x) = x^2;
s = symType(f)
```

```
s =
"expression"
```

Now check the symbolic type of $f(x) = x$ and its derivative.

```
f(x) = x;
s = symType(f)
```

```
s =
"variable"
```

```
s = symType(diff(f))
```

```
s =
"integer"
```

Inequalities and Solutions

Determine the type of various symbolic objects when solving for inequalities.

Create a quadratic function.

```
syms y(x)
y(x) = 100 - 5*x^2
```

```
y(x) = 100 - 5x2
```

Set two inequalities to the quadratic function. Check the symbolic type of each inequality.

```
eq1 = y(x) > 10;
eq2 = x > 2;
s = symType([eq1 eq2])
```

```
s = 1x2 string
    "equation"    "equation"
```

Solve the inequalities using `solve`. Return the solutions by setting 'ReturnConditions' to true.

```
eqSol = solve([eq1 eq2], 'ReturnConditions', true);
sols = eqSol.conditions
```

```
sols = x <  $\sqrt{18}$   $\wedge$  2 < x
```

Determine the symbolic type of the solutions.

```
s = symType(sols)
```

```
s =
"logicalexpression"
```

Input Arguments

symObj — Symbolic objects

symbolic numbers | symbolic variables | symbolic expressions | symbolic functions | symbolic units

Symbolic objects, specified as symbolic numbers, symbolic variables, symbolic expressions, symbolic functions, or symbolic units.

Output Arguments

s — Symbolic types

string array

Symbolic types, returned as a string array. This table shows output values for various symbolic objects.

Output	Description	Input Example
"integer"	symbolic integer number	symType(sym(' -1 '))
"rational"	symbolic rational number	symType(sym(' 1/2 '))
"vpereal"	symbolic variable-precision floating-point real number	symType([sym(' 1.5 ') vpa(' 3/2 ')])
"complex"	symbolic complex number	symType(sym(' 1+2i '))
"constant"	symbolic constant	symType(sym([pi catalan]))
"variable"	symbolic variable	syms x; symType(x)
"symfun"	unassigned symbolic function	syms f(x); symType(f)
"expression"	symbolic expression	syms x; symType(sqrt(x))
"equation"	symbolic equation and inequality	syms x; symType(x>=0)
"unit"	symbolic unit	symType(symunit('meter'))
"logical expression"	symbolic logical expression	syms x y; symType(x y)
"unsupported"	symbolic object not supported by symType	

See Also

hasSymType | isSymType | sym | symFunType | symfun | syms

Introduced in R2019a

symunit

Units of measurement

Syntax

```
u = symunit
```

Description

`u = symunit` returns the units collection. Then, specify any unit by using `u.unit`. For example, specify 3 meters as `3*u.m`. Common alternate names for units are supported, such as `u.meter` and `u.metre`. Plurals are not supported.

Examples

Specify Units of Measurement

Before specifying units, load units by using `symunit`. Then, specify a unit by using dot notation.

Specify a length of 3 meters. You can also use aliases `u.meter` or `u.metre`.

```
u = symunit;  
length = 3*u.m
```

```
length =  
3*[m]
```

Tip Use tab expansion to find names of units. Type `u.`, press **Tab**, and continue typing.

Specify the acceleration due to gravity of 9.81 meters per second squared. Because units are symbolic expressions, numeric inputs are converted to exact symbolic values. Here, 9.81 is converted to $981/100$.

```
g = 9.81*u.m/u.s^2
```

```
g =  
(981/100)*([m]/[s]^2)
```

If you are unfamiliar with the differences between symbolic and numeric arithmetic, see “Choose Numeric or Symbolic Arithmetic” on page 2-124.

Operations on Units and Conversion to Double

Units behave like symbolic expressions when you perform standard operations on them. For numeric operations, separate the value from the units, substitute for any symbolic parameters, and convert the result to double.

Find the speed required to travel 5 km in 2 hours.

```
u = symunit;  
d = 5*u.km;
```

```
t = 2*u.hr;
s = d/t

s =
(5/2)*([km]/[h])
```

The value 5/2 is symbolic. You may prefer double output, or require double output for a MATLAB function that does not accept symbolic values. Convert to double by separating the numeric value using `separateUnits` and then using `double`.

```
[sNum,sUnits] = separateUnits(s)

sNum =
5/2
sUnits =
1*([km]/[h])

sNum = double(sNum)

sNum =
2.5000
```

For the complete units workflow, see “Units of Measurement Tutorial” on page 2-19.

Convert Between Units

Use your preferred unit by rewriting units using `unitConvert`. Also, instead of specifying specific units, you can specify that the output should be in terms of SI units.

Calculate the force required to accelerate 2 kg by 5 m/s². The expression is not automatically rewritten in terms of Newtons.

```
u = symunit;
m = 2*u.kg;
a = 5*u.m/u.s^2;
F = m*a

F =
10*([kg]*[m])/[s]^2)
```

Convert the expression to newtons by using `unitConvert`.

```
F = unitConvert(F,u.N)

F =
10*[N]
```

Convert 5 cm to inches.

```
length = 5*u.cm;
length = unitConvert(length,u.in)

length =
(250/127)*[in]
```

Convert `length` to SI units. The result is in meters.

```
length = unitConvert(length,'SI')
```

```
length =  
(1/20)*[m]
```

Simplify Units of Same Dimension

Simplify expressions containing units of the same dimension by using `simplify`. Units are not automatically simplified or checked for consistency unless you call `simplify`.

```
u = symunit;  
expr = 300*u.cm + 40*u.inch + 2*u.m
```

```
expr =  
300*[cm] + 40*[in] + 2*[m]
```

```
expr = simplify(expr)
```

```
expr =  
(3008/5)*[cm]
```

`simplify` automatically chooses the unit to rewrite in terms of. To choose a specific unit, see “Convert Between Units” on page 4-1359.

Temperature: Absolute and Difference Forms

By default, temperatures are assumed to represent temperature differences. For example, `5*u.Celsius` represents a temperature difference of 5 degrees Celsius. This assumption allows arithmetical operations on temperature values and conversion between temperature scales.

To represent absolute temperatures, use degrees Kelvin so that you do not have to distinguish an absolute temperature from a temperature difference.

Convert 23 degrees Celsius to Kelvin, treating the temperature first as a temperature difference and then as an absolute temperature.

```
u = symunit;  
T = 23*u.Celsius;  
diffK = unitConvert(T,u.K)
```

```
diffK =  
23*[K]
```

```
absK = unitConvert(T,u.K,'Temperature','absolute')
```

```
absK =  
(5923/20)*[K]
```

Tips

- `1` represents a dimensionless unit. Hence, `isUnit(sym(1))` returns logical `1` (`true`).
- Certain non-linear units, such as decibels, are not implemented because arithmetic operations are not possible for these units.
- Instead of using dot notation to specify units, you can alternatively use string input as `symunit(unit)`. For example, `symunit('m')` specifies the unit meter.

See Also

`checkUnits` | `isUnit` | `newUnit` | `separateUnits` | `symunit2str` | `unitConversionFactor` | `unitConvert` | `unitInfo`

Topics

“Units of Measurement Tutorial” on page 2-19
“Unit Conversions and Unit Systems” on page 2-39
“Units and Unit Systems List” on page 2-25

External Websites

The International System of Units (SI)

Introduced in R2017a

symunit2str

Convert unit to character vector

Syntax

```
symunit2str(unit)
symunit2str(unit,toolbox)
```

Description

`symunit2str(unit)` converts the symbolic unit `unit` to a character vector.

`symunit2str(unit,toolbox)` converts the symbolic unit `unit` to a character vector representing units in the toolbox `toolbox`. The allowed values of `toolbox` are 'Aerospace', 'SimBiology', 'Simscape', or 'Simulink'.

Examples

Convert Unit to Character Vector

Convert the symbolic unit `u.km` to a character vector, where `u = symunit`.

```
u = symunit;
unitStr = symunit2str(u.km)

unitStr =
    'km'
```

Convert Unit for Specified Toolbox

Convert symbolic units to character vectors representing units in other toolboxes by specifying the toolbox name as the second argument to `symunit2str`. The allowed toolboxes are 'Aerospace', 'SimBiology', 'Simscape', or 'Simulink'. The unit must exist in the target toolbox to be valid.

Where `u = symunit`, convert `u.km/(u.hour*u.s)` to a character vector representing units from Aerospace Toolbox.

```
u = symunit;
unit = symunit2str(u.km/(u.hour*u.s), 'Aerospace')

unit =
    'km/h-s'
```

Convert `u.molecule/u.s` to a character vector representing units from SimBiology.

```
unit = symunit2str(u.molecule/u.s, 'SimBiology')

unit =
    'molecule/second'
```

Convert `u.gn/u.km` to a character vector representing units from Simscape.

```
unit = symunit2str(u.gn/u.km, 'Simscape')
```



```
unit =  
    'gee/km'
```

Convert `u.rad/u.s` to a character vector representing units from Simulink.

```
unit = symunit2str(u.rad/u.s, 'Simulink')  
  
unit =  
    'rad/s'
```

Input Arguments

unit — Symbolic unit to convert

symbolic unit

Symbolic unit to convert, specified as a symbolic unit.

toolbox — Toolbox to represent unit in

'Aerospace' | 'SimBiology' | 'Simscape' | 'Simulink'

Toolbox to represent unit in, specified as 'Aerospace', 'SimBiology', 'Simscape', or 'Simulink'.

Example: `symunit2str(u.km/u.h, 'Aerospace')`

See Also

`checkUnits` | `findUnits` | `isUnit` | `newUnit` | `separateUnits` | `str2symunit` | `symunit` | `unitConversionFactor`

Topics

“Units of Measurement Tutorial” on page 2-19

“Unit Conversions and Unit Systems” on page 2-39

“Units and Unit Systems List” on page 2-25

External Websites

The International System of Units (SI)

Introduced in R2017a

symvar

Find symbolic variables in symbolic input

Syntax

```
symvar(s)  
symvar(s,n)
```

Description

`symvar(s)` returns a vector of all symbolic variables in `s`. The variables are in alphabetical order with uppercase letters preceding lowercase letters.

`symvar(s,n)` chooses the `n` symbolic variables in `s` that are alphabetically closest to `x` and returns them in alphabetical order. If `s` is a symbolic function, `symvar(s,n)` returns the input arguments of `s` before other variables in `s`.

Examples

Find Symbolic Variables in Expression

Find all symbolic variables in an expression. `symvar` returns the variables in alphabetical order.

```
syms wa wb yx ya  
sum = wa + wb + ya + yx;  
symvar(sum)
```

```
ans =  
[ wa, wb, ya, yx]
```

Find the first three symbolic variables in an expression. `symvar` chooses variables that are alphabetically closest to `x` and returns them in alphabetical order.

```
syms a x y b  
f = a*x^2/(sin(3*y-b));  
symvar(f,3)
```

```
ans =  
[ b, x, y]
```

Find Symbolic Variables in Function

Find all symbolic variables in this function. For a symbolic function, `symvar` returns the function inputs before other variables.

```
syms x y a b  
f(x,y) = a*x^2/(sin(3*y-b));  
symvar(f)
```

```
ans =  
[ x, y, a, b]
```

```
g(x,y) = 1;
symvar(g)
```

```
ans =
 [ x, y]
```

Find the first three symbolic variables in f.

```
symvar(f,3)
```

```
ans =
 [ x, y, b]
```

Find Default Variable of Expression

When a symbolic function, such as `solve`, needs to find the default independent variable in symbolic, the function uses `symvar`. Find the default independent variable for symbolic expressions.

```
syms v z
g = v + z;
symvar(g,1)
```

```
ans =
 z
```

```
syms aaa aab
g = aaa + aab;
symvar(g,1)
```

```
ans =
 aaa
```

```
syms X1 x2 xa xb
g = X1 + x2 + xa + xb;
symvar(g,1)
```

```
ans =
 x2
```

When differentiating, integrating, substituting, or solving equations, MATLAB uses the variable returned by `symvar(s,1)` as a default variable. For a symbolic expression or matrix, `symvar(s,1)` returns the variable closest to `x`. For a function, `symvar(s,1)` returns the first input argument of `s`.

Input Arguments

s — Input

number | vector | matrix | array | symbolic number | symbolic variable | symbolic array | symbolic function | symbolic expression

Input, specified as a number, vector, matrix, or array, or a symbolic number, variable, array, function, or expression.

n — Number of variables

integer

Number of variables, specified as an integer or `Inf`. If `n` exceeds the number of variables in `s`, then `symvar` returns the number of variables in `s`.

Tips

- `symvar` treats the constants `pi`, `i`, and `j` as variables.
- If there are no symbolic variables in `s`, `symvar` returns the empty vector.

Algorithms

When `symvar` sorts the symbolic variables alphabetically, all uppercase letters have precedence over lowercase: 0 1 ... 9 A B ... Z a b ... z.

See Also

`argnames` | `sym` | `symfun` | `syms`

Topics

“Find Symbolic Variables in Expressions, Functions, Matrices” on page 2-3

Introduced in R2008b

symWriteSSC

Create new Simscape component

Syntax

```
symWriteSSC(newComponentName, templateComponentName, eqns)
symWriteSSC(newComponentName, templateComponentName, eqns, Name, Value)
```

Description

`symWriteSSC(newComponentName, templateComponentName, eqns)` creates a new Simscape component `newComponentName` using an existing component `templateComponentName` as a template and adding `eqns`. Thus, the new component has both the existing equations taken from the template component and the added equations.

`symWriteSSC(newComponentName, templateComponentName, eqns, Name, Value)` uses additional options specified by one or more `Name, Value` pair arguments.

Examples

Create Component with Additional Equation

Create a new Simscape component by using an existing component as a template and adding an equation.

Suppose you have the Simscape component `spring.ssc` in your current folder.

```
type('spring.ssc');

component spring < foundation.mechanical.rotational.branch

parameters
    spr_rate = { 10, 'N*m/rad' };
end

variables
    phi = { value = { 0, 'rad'}, priority = priority.high };
end

function setup
    if spr_rate <= 0
        pm_error('simscape:GreaterThanZero','Spring rate' )
    end
end

equations
    w == phi.der;
    t == spr_rate*phi;
end

end
```

Create symbolic variables with names of the parameters and variables of the component you are going to use when creating new equations. Also create a symbolic variable, u , to denote the energy of the rotational spring.

```
syms spr_rate phi u
```

Create the equation defining the energy u .

```
eq = u == spr_rate*phi^2/2;
```

Create the new component, `myRotationalSpring.ssc`, that is a copy of the component `spring.ssc` with an additional equation defining the energy of the rotational spring.

```
symWriteSSC('myRotationalSpring.ssc','spring.ssc',eq)
```

```
Warning: Equations contain undeclared variables 'u'.  
> In symWriteSSC (line 94)
```

`symWriteSSC` creates the component `myRotationalSpring.ssc`.

```
type('myRotationalSpring.ssc');  
  
component myRotationalSpring  
  
parameters  
    spr_rate = { 10, 'N*m/rad' };  
end  
  
variables  
    phi = { value = { 0, 'rad'}, priority = priority.high };  
end  
  
function setup  
    if spr_rate <= 0  
        pm_error('simscape:GreaterThanZero','Spring rate' )  
    end  
end  
  
equations  
    w == phi.der;  
    t == spr_rate*phi;  
    u == phi^2*spr_rate*(1.0/2.0);  
end  
  
end
```

Add Component Title and Description

Create a Simscape component with the title and descriptive text different from those of the template component.

Suppose you have the Simscape component `spring.ssc` in your current folder. This component does not have any title or descriptive text.

```
type('spring.ssc');
```

```

component spring < foundation.mechanical.rotational.branch

parameters
    spr_rate = { 10, 'N*m/rad' };
end

variables
    phi = { value = { 0, 'rad'}, priority = priority.high };
end

function setup
    if spr_rate <= 0
        pm_error('simscape:GreaterThanZero','Spring rate' )
    end
end

equations
    w == phi.der;
    t == spr_rate*phi;
end

end

```

Create symbolic variables with names of the parameters and variables of the component you are going to use when creating new equations. Also create a symbolic variable, u , to denote the energy of the rotational spring.

```
syms spr_rate phi u
```

Create the equation defining the energy u .

```
eq = u == spr_rate*phi^2/2;
```

Create the new component, `myRotationalSpring.ssc`, based on the `spring.ssc` component. Add the equation `eq`, the title “Rotational Spring”, and a few lines of descriptive text to the new component.

```

symWriteSSC('myRotationalSpring.ssc','spring.ssc',eq,...
'H1Header','% Rotational Spring',...
'HelpText',{ '% The block represents an ideal mechanical rotational linear spring.',...
              '% Connections R and C are mechanical rotational conserving ports.'...
              '% The block positive direction is from port R to port C. This means'...
              '% that the torque is positive if it acts in the direction from R to C.'})

```

```

Warning: Equations contain undeclared variables 'u'.
> In symWriteSSC (line 94)

```

`symWriteSSC` creates the component `myRotationalSpring.ssc`.

```

type('myRotationalSpring.ssc');

component myRotationalSpring
% Rotational Spring
% The block represents an ideal mechanical rotational linear spring.
% Connections R and C are mechanical rotational conserving ports.
% The block positive direction is from port R to port C. This means
% that the torque is positive if it acts in the direction from R to C.

```

```

parameters
    spr_rate = { 10, 'N*m/rad' };
end

variables
    phi = { value = { 0, 'rad'}, priority = priority.high };
end

function setup
    if spr_rate <= 0
        pm_error('simscape:GreaterThanZero','Spring rate' )
    end
end

equations
    w == phi.der;
    t == spr_rate*phi;
    u == phi^2*spr_rate*(1.0/2.0);
end

end

```

Input Arguments

newComponentName — Name of Simscape component to create

file name enclosed in single quotes

Name of Simscape component to create, specified as a file name enclosed in single quotes. File must have the extension `.ssc`. If you do not provide file extension, `symWriteSSC` assumes it to be `.ssc`. If you do not specify the absolute path, `symWriteSSC` creates the new component in the current folder.

Example: `'MyNewComponent.ssc'`

templateComponentName — Name of template Simscape component

file name enclosed in single quotes

Name of template Simscape component, specified as a file name enclosed in single quotes. File must have the extension `.ssc`. If you do not provide the file extension, `symWriteSSC` assumes it to be `.ssc`. The component must be on the MATLAB path or in the current folder.

Example: `'TemplateComponent.ssc'`

eqns — Symbolic equations

row vector

Symbolic equations, specified as a row vector.

Example: `[y(t) == diff(x(t), t), m*diff(y(t), t, t) + b*y(t) + k*x(t) == F]`

Name-Value Pair Arguments

Specify optional comma-separated pairs of `Name`, `Value` arguments. `Name` is the argument name and `Value` is the corresponding value. `Name` must appear inside quotes. You can specify several name and value pair arguments in any order as `Name1, Value1, ..., NameN, ValueN`.

Example: `symWriteSSC('myComp.ssc', 'template.ssc', eq, 'H1Header', '% New title', 'HelpText', {'% Description of the', '% new component'})`

H1Header — Title

row vector of characters

Title specified as a row vector of characters (type `char`) starting with `%`. If the first character is not `%`, then `symWriteSSC` adds `%`.

If the template component has a title and you use `H1Header`, the new component will have the title specified by `H1Header`. If the template component has a title and you call `symWriteSSC` without `H1Header`, the new component will have the same title as the template component.

Example: `'H1Header','% New title'`

HelpText — Descriptive text

cell array of row vectors of characters

Descriptive text, specified as a cell array of row vectors of characters. Each row vector must start with `%`. If the first character is not `%`, then `symWriteSSC` adds `%`.

If the template component has descriptive text and you use `HelpText`, the new component will have only the text specified by `HelpText`. In this case, `symWriteSSC` does not copy the descriptive text of the template component to the new component. If the template component has a title and you call `symWriteSSC` without `HelpText`, the new component will have the same descriptive text as the template component.

Example: `'HelpText',{'% Description of the','% new component'}`

See Also[simscapeEquation](#) | [symReadSSCParameters](#) | [symReadSSCVariables](#)**Introduced in R2016a**

tan

Symbolic tangent function

Syntax

`tan(X)`

Description

`tan(X)` returns the tangent function on page 4-1374 of X.

Examples

Tangent Function for Numeric and Symbolic Arguments

Depending on its arguments, `tan` returns floating-point or exact symbolic results.

Compute the tangent function for these numbers. Because these numbers are not symbolic objects, `tan` returns floating-point results.

```
A = tan([-2, -pi, pi/6, 5*pi/7, 11])
```

```
A =  
    2.1850    0.0000    0.5774   -1.2540  -225.9508
```

Compute the tangent function for the numbers converted to symbolic objects. For many symbolic (exact) numbers, `tan` returns unresolved symbolic calls.

```
symA = tan(sym([-2, -pi, pi/6, 5*pi/7, 11]))
```

```
symA =  
[ -tan(2), 0, 3^(1/2)/3, -tan((2*pi)/7), tan(11)]
```

Use `vpa` to approximate symbolic results with floating-point numbers:

```
vpa(symA)
```

```
ans =  
[ 2.1850398632615189916433061023137, ...  
 0, ...  
 0.57735026918962576450914878050196, ...  
 -1.2539603376627038375709109783365, ...  
 -225.95084645419514202579548320345]
```

Plot Tangent Function

Plot the tangent function on the interval from $-\pi$ to π .

```
syms x  
fplot(tan(x), [-pi pi])  
grid on
```

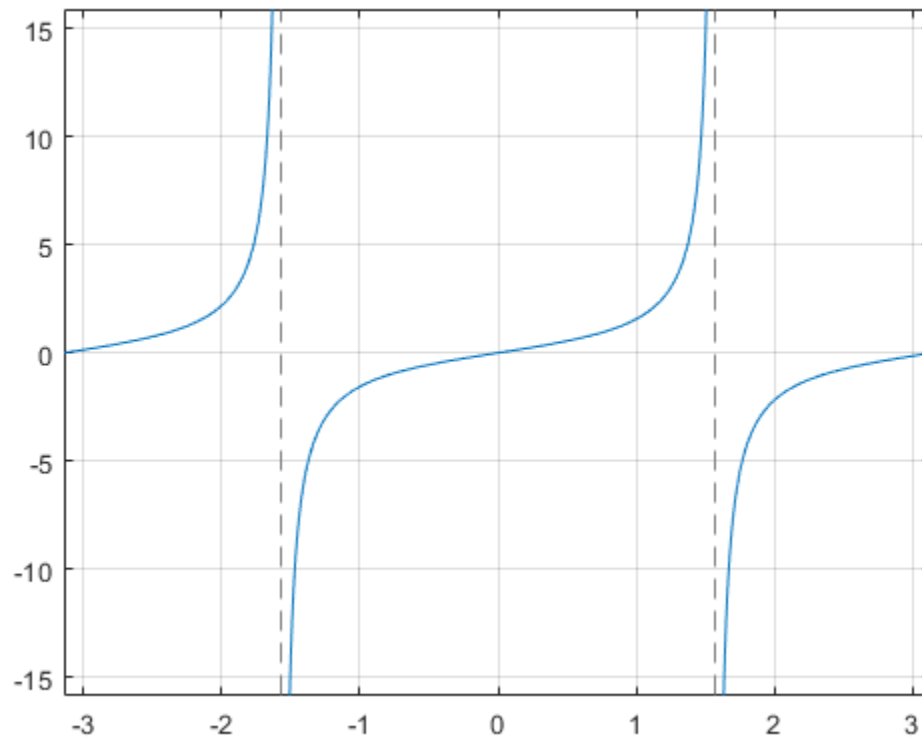

Handle Expressions Containing Tangent Function

Many functions, such as `diff`, `int`, `taylor`, and `rewrite`, can handle expressions containing `tan`.

Find the first and second derivatives of the tangent function:

```
syms x
diff(tan(x), x)
diff(tan(x), x, x)
```

```
ans =
tan(x)^2 + 1
```

```
ans =
2*tan(x)*(tan(x)^2 + 1)
```

Find the indefinite integral of the tangent function:

```
int(tan(x), x)
```

```
ans =
-log(cos(x))
```

Find the Taylor series expansion of $\tan(x)$:

```
taylor(tan(x), x)
```

```
ans =
(2*x^5)/15 + x^3/3 + x
```

Rewrite the tangent function in terms of the sine and cosine functions:

```
rewrite(tan(x), 'sincos')
```

```
ans =
sin(x)/cos(x)
```

Rewrite the tangent function in terms of the exponential function:

```
rewrite(tan(x), 'exp')
```

```
ans =
-(exp(x*2i)*1i - 1i)/(exp(x*2i) + 1)
```

Evaluate Units with tan Function

`tan` numerically evaluates these units automatically: radian, degree, arcmin, arcsec, and revolution.

Show this behavior by finding the tangent of x degrees and 2 radians.

```
u = symunit;
syms x
f = [x*u.degree 2*u.radian];
tanf = tan(f)
```

```
tanf =
[ tan((pi*x)/180), tan(2)]
```

You can calculate `tanf` by substituting for x using `subs` and then using `double` or `vpa`.

Input Arguments

X — Input

symbolic number | symbolic variable | symbolic expression | symbolic function | symbolic vector | symbolic matrix

Input, specified as a symbolic number, variable, expression, or function, or as a vector or matrix of symbolic numbers, variables, expressions, or functions.

More About

Tangent Function

The tangent of an angle, α , defined with reference to a right angled triangle is

$$\tan(\alpha) = \frac{\text{opposite side}}{\text{adjacent side}} = \frac{a}{b} \cdot$$

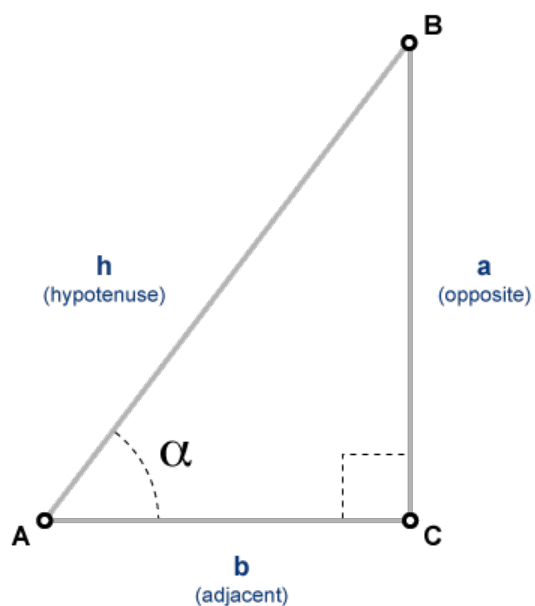

The tangent of a complex argument, α , is

$$\tan(\alpha) = \frac{e^{i\alpha} - e^{-i\alpha}}{i(e^{i\alpha} + e^{-i\alpha})}.$$

See Also

acos | acot | acsc | asec | asin | atan | cos | cot | csc | sec | sin

Introduced before R2006a

tanh

Symbolic hyperbolic tangent function

Syntax

`tanh(X)`

Description

`tanh(X)` returns the hyperbolic tangent function of X .

Examples

Hyperbolic Tangent Function for Numeric and Symbolic Arguments

Depending on its arguments, `tanh` returns floating-point or exact symbolic results.

Compute the hyperbolic tangent function for these numbers. Because these numbers are not symbolic objects, `tanh` returns floating-point results.

```
A = tanh([-2, -pi*i, pi*i/6, pi*i/3, 5*pi*i/7])
A =
-0.9640 + 0.0000i    0.0000 + 0.0000i    0.0000 + 0.5774i...
 0.0000 + 1.7321i    0.0000 - 1.2540i
```

Compute the hyperbolic tangent function for the numbers converted to symbolic objects. For many symbolic (exact) numbers, `tanh` returns unresolved symbolic calls.

```
symA = tanh(sym([-2, -pi*i, pi*i/6, pi*i/3, 5*pi*i/7]))
symA =
[ -tanh(2), 0, (3^(1/2)*1i)/3, 3^(1/2)*1i, -tanh((pi*2i)/7)]
```

Use `vpa` to approximate symbolic results with floating-point numbers:

```
vpa(symA)
ans =
[ -0.96402758007581688394641372410092,...
 0,...
 0.57735026918962576450914878050196i,...
 1.7320508075688772935274463415059i,...
 -1.2539603376627038375709109783365i]
```

Plot Hyperbolic Tangent Function

Plot the hyperbolic tangent function on the interval from $-\pi$ to π .

```
syms x
fplot(tanh(x),[-pi pi])
grid on
```

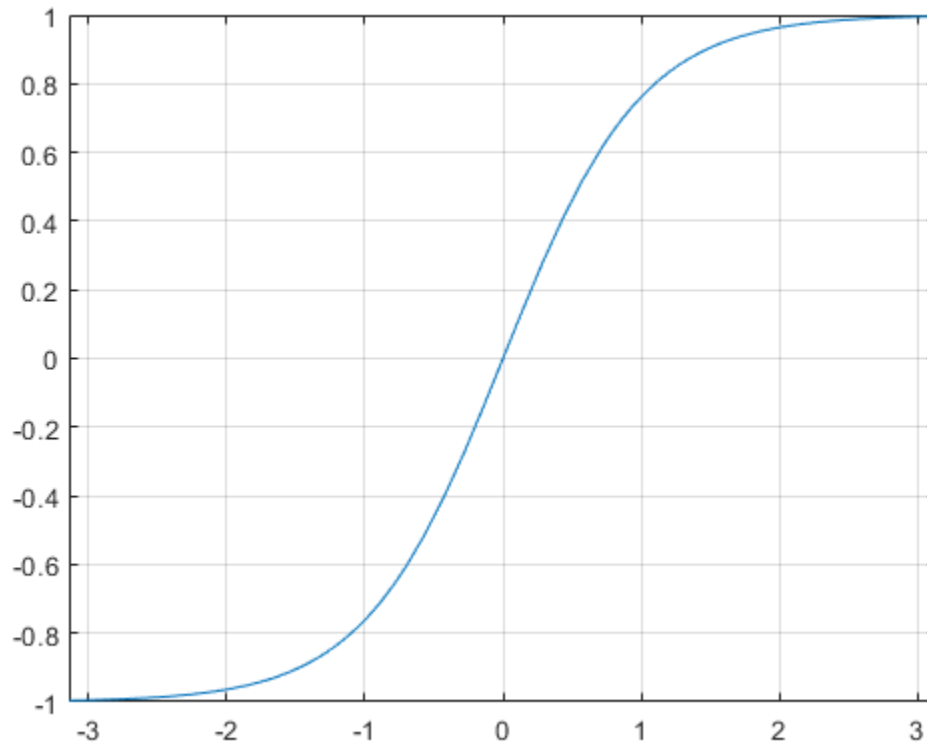

Handle Expressions Containing Hyperbolic Tangent Function

Many functions, such as `diff`, `int`, `taylor`, and `rewrite`, can handle expressions containing `tanh`.

Find the first and second derivatives of the hyperbolic tangent function:

```
syms x
diff(tanh(x), x)
diff(tanh(x), x, x)
```

```
ans =
1 - tanh(x)^2
```

```
ans =
2*tanh(x)*(tanh(x)^2 - 1)
```

Find the indefinite integral of the hyperbolic tangent function:

```
int(tanh(x), x)
```

```
ans =
log(cosh(x))
```

Find the Taylor series expansion of `tanh(x)`:

```
taylor(tanh(x), x)
```

```
ans =  
(2*x^5)/15 - x^3/3 + x
```

Rewrite the hyperbolic tangent function in terms of the exponential function:

```
rewrite(tanh(x), 'exp')
```

```
ans =  
(exp(2*x) - 1)/(exp(2*x) + 1)
```

Input Arguments

X — Input

symbolic number | symbolic variable | symbolic expression | symbolic function | symbolic vector | symbolic matrix

Input, specified as a symbolic number, variable, expression, or function, or as a vector or matrix of symbolic numbers, variables, expressions, or functions.

See Also

acosh | acoth | acsch | asech | asinh | atanh | cosh | coth | csch | sech | sinh

Introduced before R2006a

taylor

Taylor series

Syntax

```
T = taylor(f,var)
T = taylor(f,var,a)
T = taylor( ___,Name,Value)
```

Description

`T = taylor(f,var)` approximates `f` with the Taylor series expansion on page 4-1384 of `f` up to the fifth order at the point `var = 0`. If you do not specify `var`, then `taylor` uses the default variable determined by `symvar(f,1)`.

`T = taylor(f,var,a)` approximates `f` with the Taylor series expansion of `f` at the point `var = a`.

`T = taylor(___,Name,Value)` uses additional options specified by one or more `Name,Value` pair arguments. You can specify `Name,Value` after the input arguments in any of the previous syntaxes.

Examples

Find Maclaurin Series of Univariate Expressions

Find the Maclaurin series expansions of the exponential, sine, and cosine functions up to the fifth order.

```
syms x
T1 = taylor(exp(x))
T2 = taylor(sin(x))
T3 = taylor(cos(x))
```

```
T1 =
x^5/120 + x^4/24 + x^3/6 + x^2/2 + x + 1
```

```
T2 =
x^5/120 - x^3/6 + x
```

```
T3 =
x^4/24 - x^2/2 + 1
```

You can use the `sympref` function to modify the output order of symbolic polynomials. Redisplay the polynomials in ascending order.

```
sympref('PolynomialDisplayStyle','ascend');
T1
T2
T3
```

```
T1 =
1 + x + x^2/2 + x^3/6 + x^4/24 + x^5/120
```

```
T2 =  
x - x^3/6 + x^5/120
```

```
T3 =  
1 - x^2/2 + x^4/24
```

The display format you set using `sympref` persists through your current and future MATLAB sessions. Restore the default value by specifying the `'default'` option.

```
sympref('default');
```

Specify Expansion Point

Find the Taylor series expansions at $x = 1$ for these functions. The default expansion point is 0. To specify a different expansion point, use `ExpansionPoint`:

```
syms x  
T = taylor(log(x), x, 'ExpansionPoint', 1)  
  
T =  
x - (x - 1)^2/2 + (x - 1)^3/3 - (x - 1)^4/4 + (x - 1)^5/5 - 1
```

Alternatively, specify the expansion point as the third argument of `taylor`:

```
T = taylor(acot(x), x, 1)  
  
T =  
pi/4 - x/2 + (x - 1)^2/4 - (x - 1)^3/12 + (x - 1)^5/40 + 1/2
```

Specify Truncation Order

Find the Maclaurin series expansion for $f = \sin(x)/x$. The default truncation order is 6. Taylor series approximation of this expression does not have a fifth-degree term, so `taylor` approximates this expression with the fourth-degree polynomial:

```
syms x  
f = sin(x)/x;  
T6 = taylor(f, x)  
  
T6 =  
x^4/120 - x^2/6 + 1
```

Use `Order` to control the truncation order. For example, approximate the same expression up to the orders 8 and 10:

```
T8 = taylor(f, x, 'Order', 8)  
T10 = taylor(f, x, 'Order', 10)  
  
T8 =  
- x^6/5040 + x^4/120 - x^2/6 + 1  
  
T10 =  
x^8/362880 - x^6/5040 + x^4/120 - x^2/6 + 1
```

Plot the original expression f and its approximations T_6 , T_8 , and T_{10} . Note how the accuracy of the approximation depends on the truncation order.

```
fplot([T6 T8 T10 f])
xlim([-4 4])
grid on

legend('approximation of sin(x)/x up to O(x^6)',...
       'approximation of sin(x)/x up to O(x^8)',...
       'approximation of sin(x)/x up to O(x^{10})',...
       'sin(x)/x', 'Location', 'Best')
title('Taylor Series Expansion')
```

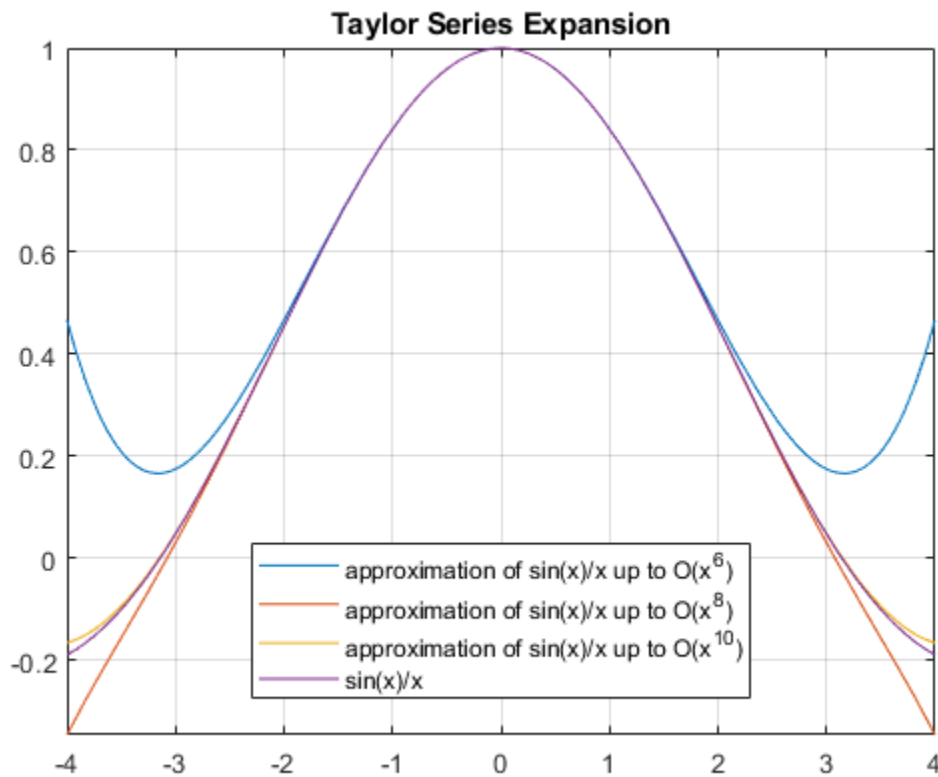

Specify Order Mode: Relative or Absolute

Find the Taylor series expansion of this expression. By default, `taylor` uses an absolute order, which is the truncation order of the computed series.

```
T = taylor(1/(exp(x)) - exp(x) + 2*x, x, 'Order', 5)
```

```
T =
-x^3/3
```

Find the Taylor series expansion with a relative truncation order by using `OrderMode`. For some expressions, a relative truncation order provides more accurate approximations.

```
T = taylor(1/(exp(x)) - exp(x) + 2*x, x, 'Order', 5, 'OrderMode', 'relative')
T =
- x^7/2520 - x^5/60 - x^3/3
```

Find Maclaurin Series of Multivariate Expressions

Find the Maclaurin series expansion of this multivariate expression. If you do not specify the vector of variables, `taylor` treats `f` as a function of one independent variable.

```
syms x y z
f = sin(x) + cos(y) + exp(z);
T = taylor(f)

T =
x^5/120 - x^3/6 + x + cos(y) + exp(z)
```

Find the multivariate Maclaurin expansion by specifying the vector of variables.

```
syms x y z
f = sin(x) + cos(y) + exp(z);
T = taylor(f, [x, y, z])

T =
x^5/120 - x^3/6 + x + y^4/24 - y^2/2 + z^5/120 + z^4/24 + z^3/6 + z^2/2 + z + 2
```

You can use the `sympref` function to modify the output order of a symbolic polynomial. Redisplay the polynomial in ascending order.

```
sympref('PolynomialDisplayStyle','ascend');
T

T =
2 + z + z^2/2 + z^3/6 + z^4/24 + z^5/120 - y^2/2 + y^4/24 + x - x^3/6 + x^5/120
```

The display format you set using `sympref` persists through your current and future MATLAB sessions. Restore the default value by specifying the `'default'` option.

```
sympref('default');
```

Specify Expansion Point for Multivariate Expression

Find the multivariate Taylor expansion by specifying both the vector of variables and the vector of values defining the expansion point:

```
syms x y
f = y*exp(x - 1) - x*log(y);
T = taylor(f, [x, y], [1, 1], 'Order', 3)

T =
x + (x - 1)^2/2 + (y - 1)^2/2
```

If you specify the expansion point as a scalar `a`, `taylor` transforms that scalar into a vector of the same length as the vector of variables. All elements of the expansion vector equal `a`:

```
T = taylor(f, [x, y], 1, 'Order', 3)
```

$$T = x + (x - 1)^2/2 + (y - 1)^2/2$$

Input Arguments

f — Input to approximate

symbolic expression | symbolic function | symbolic vector | symbolic matrix | symbolic multidimensional array

Input to approximate, specified as a symbolic expression or function. It also can be a vector, matrix, or multidimensional array of symbolic expressions or functions.

var — Expansion variable

symbolic variable

Expansion variable, specified as a symbolic variable. If you do not specify `var`, then `taylor` uses the default variable determined by `symvar(f,1)`.

a — Expansion point

0 (default) | number | symbolic number | symbolic variable | symbolic function | symbolic expression

Expansion point, specified as a number, or a symbolic number, variable, function, or expression. The expansion point cannot depend on the expansion variable. You also can specify the expansion point as a `Name,Value` pair argument. If you specify the expansion point both ways, then the `Name,Value` pair argument takes precedence.

Name-Value Pair Arguments

Specify optional comma-separated pairs of `Name,Value` arguments. `Name` is the argument name and `Value` is the corresponding value. `Name` must appear inside quotes. You can specify several name and value pair arguments in any order as `Name1,Value1,...,NameN,ValueN`.

Example: `taylor(log(x),x,'ExpansionPoint',1,'Order',9)`

ExpansionPoint — Expansion point

0 (default) | number | symbolic number | symbolic variable | symbolic function | symbolic expression

Expansion point, specified as a number, or a symbolic number, variable, function, or expression. The expansion point cannot depend on the expansion variable. You can also specify the expansion point using the input argument `a`. If you specify the expansion point both ways, then the `Name,Value` pair argument takes precedence.

Order — Truncation order of Taylor series expansion

6 (default) | positive integer | symbolic positive integer

Truncation order of Taylor series expansion, specified as a positive integer or a symbolic positive integer. `taylor` computes the Taylor series approximation with the order $n - 1$. The truncation order n is the exponent in the O -term: $O(var^n)$.

OrderMode — Order mode indicator

'absolute' (default) | 'relative'

Order mode indicator, specified as 'absolute' or 'relative'. This indicator specifies whether you want to use absolute or relative order when computing the Taylor polynomial approximation.

Absolute order is the truncation order of the computed series. Relative order n means that the exponents of var in the computed series range from the leading order m to the highest exponent $m + n - 1$. Here $m + n$ is the exponent of var in the O -term: $O(\text{var}^{m+n})$.

More About

Taylor Series Expansion

Taylor series expansion represents an analytic function $f(x)$ as an infinite sum of terms around the expansion point $x = a$:

$$f(x) = f(a) + \frac{f'(a)}{1!}(x-a) + \frac{f''(a)}{2!}(x-a)^2 + \dots = \sum_{m=0}^{\infty} \frac{f^{(m)}(a)}{m!} \cdot (x-a)^m$$

Taylor series expansion requires a function to have derivatives up to an infinite order around the expansion point.

Maclaurin Series Expansion

Taylor series expansion around $x = 0$ is called Maclaurin series expansion:

$$f(x) = f(0) + \frac{f'(0)}{1!}x + \frac{f''(0)}{2!}x^2 + \dots = \sum_{m=0}^{\infty} \frac{f^{(m)}(0)}{m!}x^m$$

Tips

- If you use both the third argument `a` and `ExpansionPoint` to specify the expansion point, the value specified via `ExpansionPoint` prevails.
- If `var` is a vector, then the expansion point `a` must be a scalar or a vector of the same length as `var`. If `var` is a vector and `a` is a scalar, then `a` is expanded into a vector of the same length as `var` with all elements equal to `a`.
- If the expansion point is infinity or negative infinity, then `taylor` computes the Laurent series expansion, which is a power series in $1/\text{var}$.
- You can use the `sympref` function to modify the output order of symbolic polynomials.

See Also

`coeffs` | `pade` | `polynomialDegree` | `series` | `sympref` | `symvar`

Topics

“Taylor Series” on page 2-67

Introduced before R2006a

taylortool

Taylor series calculator

Syntax

```
taylortool  
taylortool(f)
```

Description

`taylortool` initiates a GUI that computes the Taylor series expansion. The GUI that graphs a function against the Nth partial sum of its Taylor series about a base point $x = a$. The default function, value of N, base point, and interval of computation for `taylortool` are $f = x \cdot \cos(x)$, $N = 7$, $a = 0$, and $[-2\pi, 2\pi]$, respectively.

`taylortool(f)` initiates the GUI that computes the Taylor series expansion of the given expression f .

Examples

Find Taylor Series Expansion of Function

Open a GUI that computes the Taylor series expansion. By default, the GUI shows the Taylor series expansion of the function $f(x) = x \cdot \cos(x)$. The blue solid line shows the function $f(x)$ and the red dashed line shows its Taylor approximation.

```
taylortool
```

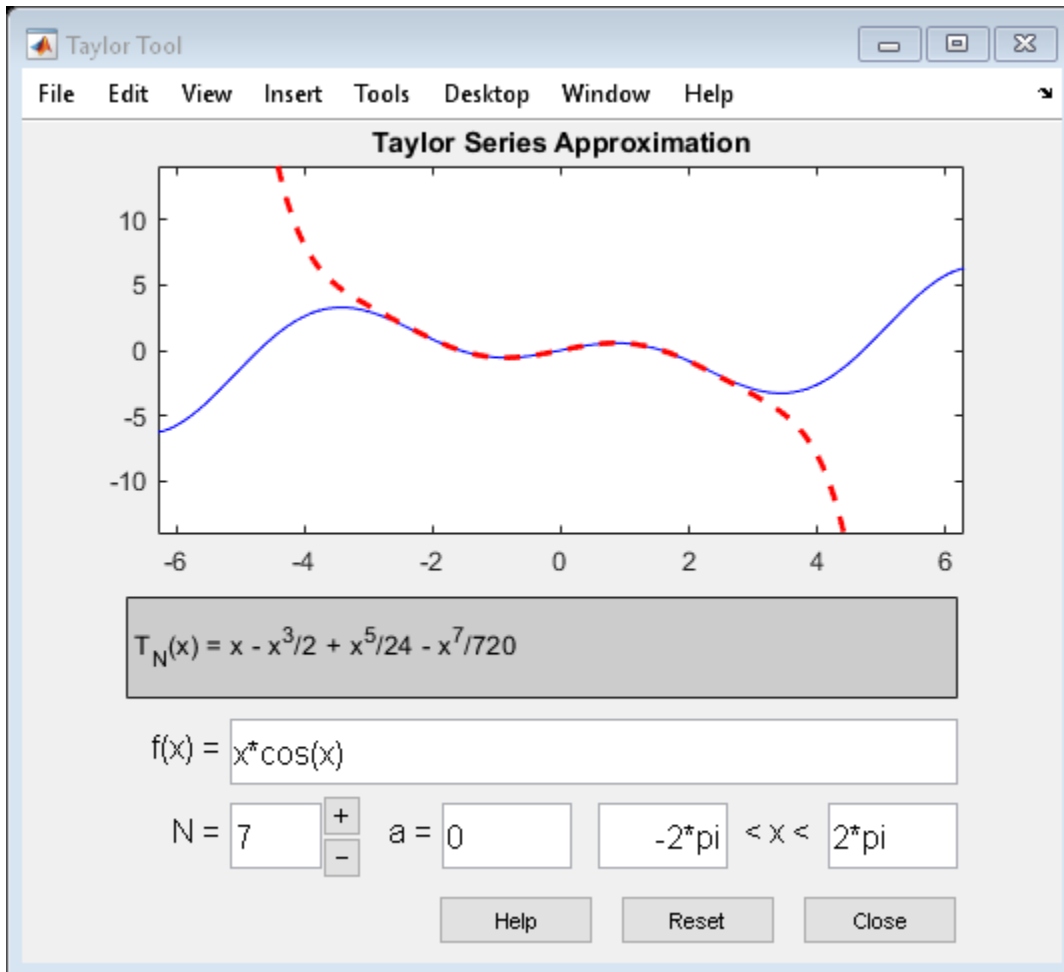

Next, find the Taylor series expansion of the function $\cos(x)$.

```
syms x
taylortool(cos(x))
```

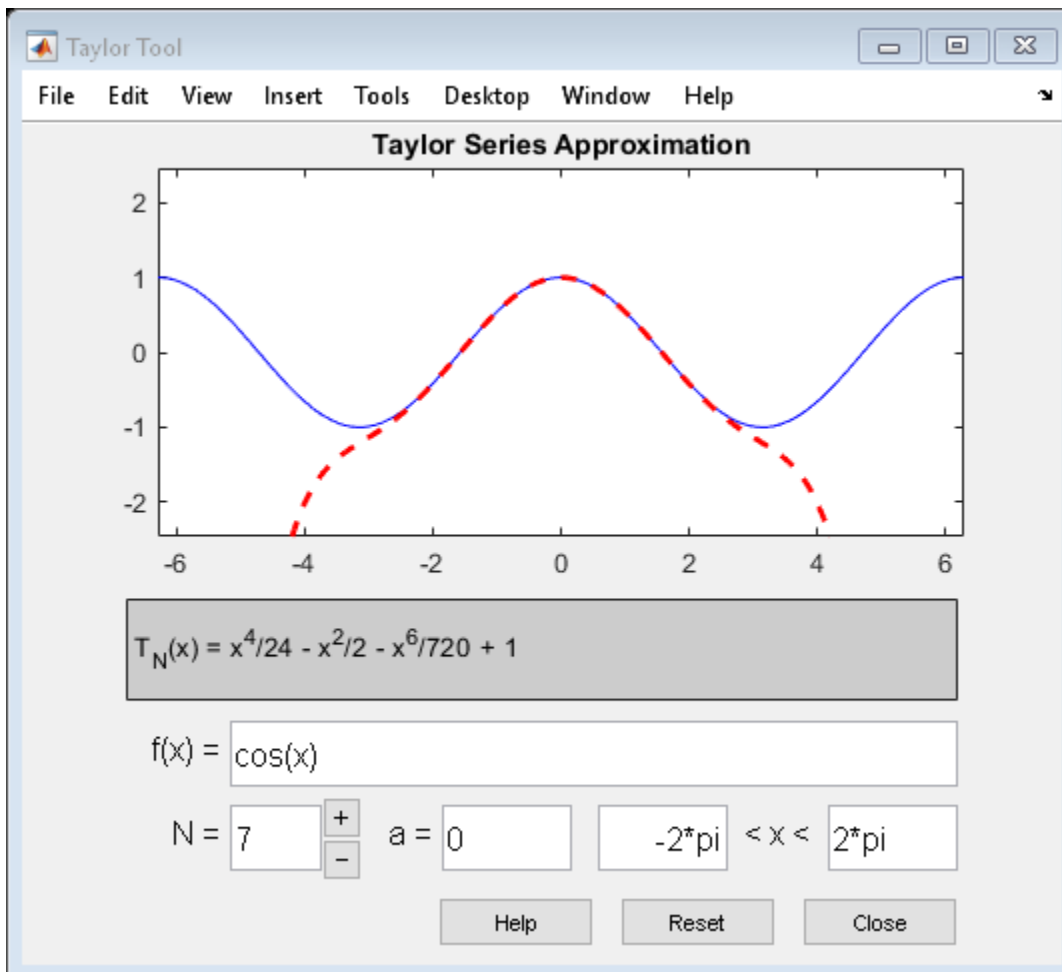
Input Arguments

f – Input to approximate

symbolic expression | symbolic function

Input to approximate, specified as a symbolic expression or function.

See Also

funtool | rsums | taylor

Topics

"Taylor Series" on page 2-67

Introduced before R2006a

texlabel

TeX representation of symbolic expression

Syntax

```
texlabel(expr)
texlabel(expr, 'literal')
```

Description

`texlabel(expr)` converts the symbolic expression `expr` into the TeX equivalent for use in character vectors. `texlabel` converts Greek variable names, such as `delta`, into Greek letters. Annotation functions, such as `title`, `xlabel`, and `text` can use the TeX character vector as input. To obtain the LaTeX representation, use `latex`.

`texlabel(expr, 'literal')` interprets Greek variable names literally.

Examples

Generate TeX Character Vector

Use `texlabel` to generate TeX character vectors for these symbolic expressions.

```
syms x y lambda12 delta
texlabel(sin(x) + x^3)
texlabel(3*(1-x)^2*exp(-(x^2) - (y+1)^2))
texlabel(lambda12^(3/2)/pi - pi*delta^(2/3))

ans =
    '{sin}({x}) + {x}^{3}'

ans =
    '{3} {exp}(- ({y} + {1})^{2} - {x}^{2}) ({x} - {1})^{2}'

ans =
    '{\lambda_{12}}^{\{3\}/\{2\}}/{\pi} - {\delta}^{\{2\}/\{3\}} {\pi}'
```

To make `texlabel` interpret Greek variable names literally, include the argument `'literal'`.

```
texlabel(lambda12, 'literal')
```

```
ans =
    '{lambda12}'
```

Insert TeX in Figure

Plot $y = x^2$ using `fplot`. Show the plotted expression `y` by using `texlabel` to generate a TeX character vector that `text` inserts into the figure.

```
syms x
y = x^2;
fplot(y)
```

```
ylabel = texlabel(y);  
text(1, 15, ['y = ' ylabel]);
```

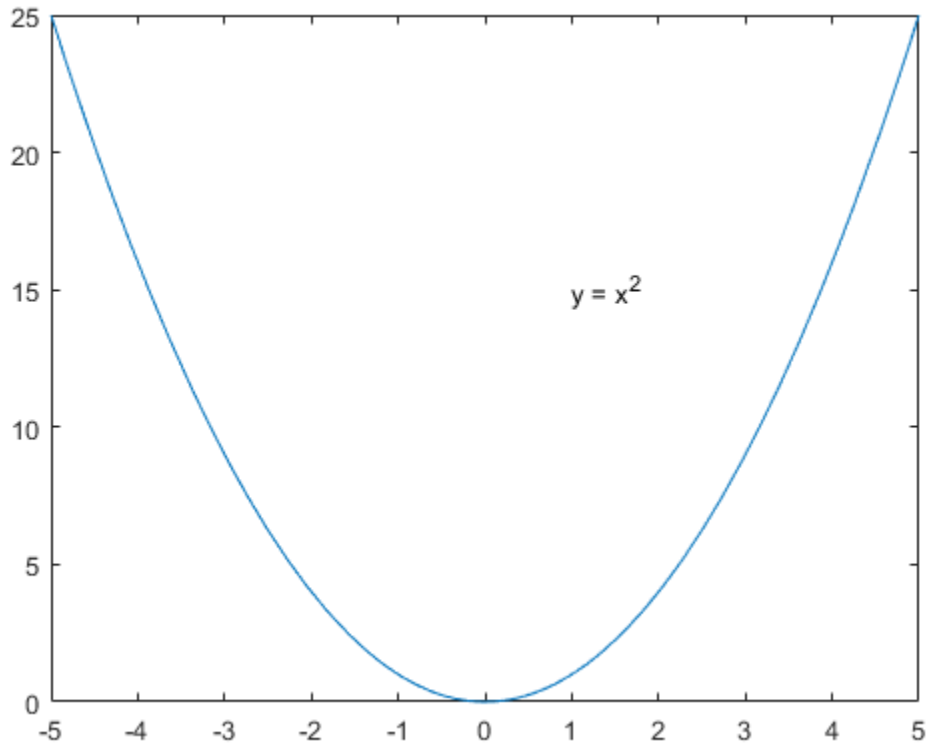

Input Arguments

expr — Expression to be converted

symbolic expression

Expression to be converted, specified as a symbolic expression.

See Also

`latex` | `text` | `title` | `xlabel` | `ylabel` | `zlabel`

Introduced before R2006a

times, .*

Symbolic array multiplication

Syntax

```
A.*B  
times(A,B)
```

Description

A.*B performs elementwise multiplication of A and B.

times(A,B) is equivalent to A.*B.

Examples

Multiply Matrix by Scalar

Create a 2-by-3 matrix.

```
A = sym('a', [2 3])  
  
A =  
[ a1_1, a1_2, a1_3]  
[ a2_1, a2_2, a2_3]
```

Multiply the matrix by the symbolic expression `sin(b)`. Multiplying a matrix by a scalar means multiplying each element of the matrix by that scalar.

```
syms b  
A.*sin(b)  
  
ans =  
[ a1_1*sin(b), a1_2*sin(b), a1_3*sin(b)]  
[ a2_1*sin(b), a2_2*sin(b), a2_3*sin(b)]
```

Multiply Two Matrices

Create a 3-by-3 symbolic Hilbert matrix and a 3-by-3 diagonal matrix.

```
H = sym(hilb(3))  
d = diag(sym([1 2 3]))  
  
H =  
[ 1, 1/2, 1/3]  
[ 1/2, 1/3, 1/4]  
[ 1/3, 1/4, 1/5]  
  
d =  
[ 1, 0, 0]  
[ 0, 2, 0]  
[ 0, 0, 3]
```

Multiply the matrices by using the elementwise multiplication operator `.*`. This operator multiplies each element of the first matrix by the corresponding element of the second matrix. The dimensions of the matrices must be the same.

`H.*d`

```
ans =
[ 1, 0, 0]
[ 0, 2/3, 0]
[ 0, 0, 3/5]
```

Multiply Expression by Symbolic Function

Multiply a symbolic expression by a symbolic function. The result is a symbolic function.

```
syms f(x)
f(x) = x^2;
f1 = (x^2 + 5*x + 6).*f
```

```
f1(x) =
x^2*(x^2 + 5*x + 6)
```

Input Arguments

A — Input

number | symbolic number | symbolic variable | symbolic vector | symbolic matrix | symbolic multidimensional array | symbolic function | symbolic expression

Input, specified as a number or a symbolic number, variable, vector, matrix, multidimensional array, function, or expression. Inputs A and B must be the same size unless one is a scalar. A scalar value expands into an array of the same size as the other input.

B — Input

number | symbolic number | symbolic variable | symbolic vector | symbolic matrix | symbolic multidimensional array | symbolic function | symbolic expression

Input, specified as a number or a symbolic number, variable, vector, matrix, multidimensional array, function, or expression. Inputs A and B must be the same size unless one is a scalar. A scalar value expands into an array of the same size as the other input.

See Also

`ctranspose` | `ldivide` | `minus` | `mldivide` | `mpower` | `mrdivide` | `mtimes` | `plus` | `power` | `rdivide` | `transpose`

Introduced before R2006a

toeplitz

Symbolic Toeplitz matrix

Syntax

```
toeplitz(c,r)
toeplitz(r)
```

Description

`toeplitz(c,r)` generates a nonsymmetric Toeplitz matrix on page 4-1394 having `c` as its first column and `r` as its first row. If the first elements of `c` and `r` are different, `toeplitz` issues a warning and uses the first element of the column.

`toeplitz(r)` generates a symmetric Toeplitz matrix if `r` is real. If `r` is complex, but its first element is real, then this syntax generates the Hermitian Toeplitz matrix formed from `r`. If the first element of `r` is not real, then the resulting matrix is Hermitian off the main diagonal, meaning that $T_{ij} = \text{conjugate}(T_{ji})$ for $i \neq j$.

Examples

Generate Toeplitz Matrix

Generate the Toeplitz matrix from these vectors. Because these vectors are not symbolic objects, you get floating-point results.

```
c = [1 2 3 4 5 6];
r = [1 3/2 3 7/2 5];
toeplitz(c,r)
```

```
ans =
    1.0000    1.5000    3.0000    3.5000    5.0000
    2.0000    1.0000    1.5000    3.0000    3.5000
    3.0000    2.0000    1.0000    1.5000    3.0000
    4.0000    3.0000    2.0000    1.0000    1.5000
    5.0000    4.0000    3.0000    2.0000    1.0000
    6.0000    5.0000    4.0000    3.0000    2.0000
```

Now, convert these vectors to a symbolic object, and generate the Toeplitz matrix:

```
c = sym([1 2 3 4 5 6]);
r = sym([1 3/2 3 7/2 5]);
toeplitz(c,r)
```

```
ans =
[ 1, 3/2, 3, 7/2, 5]
[ 2, 1, 3/2, 3, 7/2]
[ 3, 2, 1, 3/2, 3]
[ 4, 3, 2, 1, 3/2]
[ 5, 4, 3, 2, 1]
[ 6, 5, 4, 3, 2]
```

Generate Toeplitz Matrix from Vector

Generate the Toeplitz matrix from this vector:

```
syms a b c d
T = toeplitz([a b c d])

T =
[      a,      b,      c,      d]
[ conj(b),      a,      b,      c]
[ conj(c), conj(b),      a,      b]
[ conj(d), conj(c), conj(b),      a]
```

If you specify that all elements are real, then the resulting Toeplitz matrix is symmetric:

```
syms a b c d real
T = toeplitz([a b c d])

T =
[ a, b, c, d]
[ b, a, b, c]
[ c, b, a, b]
[ d, c, b, a]
```

For further computations, clear the assumptions by recreating the variables using `syms`:

```
syms a b c d
```

Generate Toeplitz with Complex Values

Generate the Toeplitz matrix from a vector containing complex numbers:

```
T = toeplitz(sym([1, 2, i]))

T =
[ 1, 2, 1i]
[ 2, 1, 2]
[-1i, 2, 1]
```

If the first element of the vector is real, then the resulting Toeplitz matrix is Hermitian:

```
isAlways(T == T')

ans =
 3x3 logical array
 1 1 1
 1 1 1
 1 1 1
```

If the first element is not real, then the resulting Toeplitz matrix is Hermitian off the main diagonal:

```
T = toeplitz(sym([i, 2, 1]))

T =
[ 1i, 2, 1]
[ 2, 1i, 2]
[ 1, 2, 1i]

isAlways(T == T')
```

```
ans =
  3×3 logical array
   0     1     1
   1     0     1
   1     1     0
```

Use Vectors with Conflicting First Element

Generate a Toeplitz matrix using these vectors to specify the first column and the first row. Because the first elements of these vectors are different, `toeplitz` issues a warning and uses the first element of the column:

```
syms a b c
toeplitz([a b c], [1 b/2 a/2])
```

```
Warning: First element of given column does not match first element of given row.
Column wins diagonal conflict.
```

```
ans =
 [ a, b/2, a/2]
 [ b,  a, b/2]
 [ c,  b,  a]
```

Input Arguments

c — First column of Toeplitz matrix

vector | symbolic vector

First column of Toeplitz matrix, specified as a vector or symbolic vector.

r — First row of Toeplitz matrix

vector | symbolic vector

First row of Toeplitz matrix, specified as a vector or symbolic vector.

More About

Toeplitz Matrix

A Toeplitz matrix is a matrix that has constant values along each descending diagonal from left to right. For example, matrix T is a symmetric Toeplitz matrix:

$$T = \begin{pmatrix} t_0 & t_1 & t_2 & & & t_k \\ t_{-1} & t_0 & t_1 & \cdots & & \\ t_{-2} & t_{-1} & t_0 & & & \\ & \vdots & \ddots & & & \vdots \\ & & & t_0 & t_1 & t_2 \\ & & & \cdots & t_{-1} & t_0 & t_1 \\ t_{-k} & & & & t_{-2} & t_{-1} & t_0 \end{pmatrix}$$

Tips

- Calling `toeplitz` for numeric arguments that are not symbolic objects invokes the MATLAB `toeplitz` function.

See Also

toeplitz

Introduced in R2013a

transpose, .'

Symbolic matrix transpose

Syntax

```
A.'  
transpose(A)
```

Description

A.' computes the nonconjugate transpose on page 4-1397 of A.

transpose(A) is equivalent to A.'.

Examples

Transpose of Real Matrix

Create a 2-by-3 matrix, the elements of which represent real numbers.

```
syms x y real  
A = [x x x; y y y]
```

```
A =  
[ x, x, x]  
[ y, y, y]
```

Find the nonconjugate transpose of this matrix.

```
A.'  
  
ans =  
[ x, y]  
[ x, y]  
[ x, y]
```

If all elements of a matrix represent real numbers, then its complex conjugate transform equals its nonconjugate transform.

```
isAlways(A' == A.)  
  
ans =  
 3x2 logical array  
 1 1  
 1 1  
 1 1
```

Transpose of Complex Matrix

Create a 2-by-2 matrix, the elements of which represent complex numbers.

```
syms x y real  
A = [x + y*i x - y*i; y + x*i y - x*i]
```

```
A =
[ x + y*1i, x - y*1i]
[ y + x*1i, y - x*1i]
```

Find the nonconjugate transpose of this matrix. The nonconjugate transpose operator, `A.'`, performs a transpose without conjugation. That is, it does not change the sign of the imaginary parts of the elements.

```
A.'
```

```
ans =
[ x + y*1i, y + x*1i]
[ x - y*1i, y - x*1i]
```

For a matrix of complex numbers with nonzero imaginary parts, the nonconjugate transform is not equal to the complex conjugate transform.

```
isAlways(A.' == A', 'Unknown', 'false')
```

```
ans =
 2x2 logical array
     0     0
     0     0
```

Input Arguments

A — Input

number | symbolic number | symbolic variable | symbolic expression | symbolic vector | symbolic matrix | symbolic multidimensional array

Input, specified as a number or a symbolic number, variable, expression, vector, matrix, multidimensional array.

More About

Nonconjugate Transpose

The nonconjugate transpose of a matrix interchanges the row and column index for each element, reflecting the elements across the main diagonal. The diagonal elements themselves remain unchanged. This operation does not affect the sign of the imaginary parts of complex elements.

For example, if `B = A.'` and `A(3,2)` is `1+1i`, then the element `B(2,3)` is `1+1i`.

See Also

`ctranspose` | `ldivide` | `minus` | `mldivide` | `mpower` | `mrdivide` | `mtimes` | `plus` | `power` | `rdivide` | `times`

Introduced before R2006a

triangularPulse

Triangular pulse function

Syntax

```
triangularPulse(a,b,c,x)  
triangularPulse(a,c,x)  
triangularPulse(x)
```

Description

`triangularPulse(a,b,c,x)` returns the “Triangular Pulse Function” on page 4-1402.

`triangularPulse(a,c,x)` is a shortcut for `triangularPulse(a, (a + c)/2, c, x)`.

`triangularPulse(x)` is a shortcut for `triangularPulse(-1, 0, 1, x)`.

Examples

Plot Triangular Pulse Function

```
syms x  
fplot(triangularPulse(x), [-2 2])
```

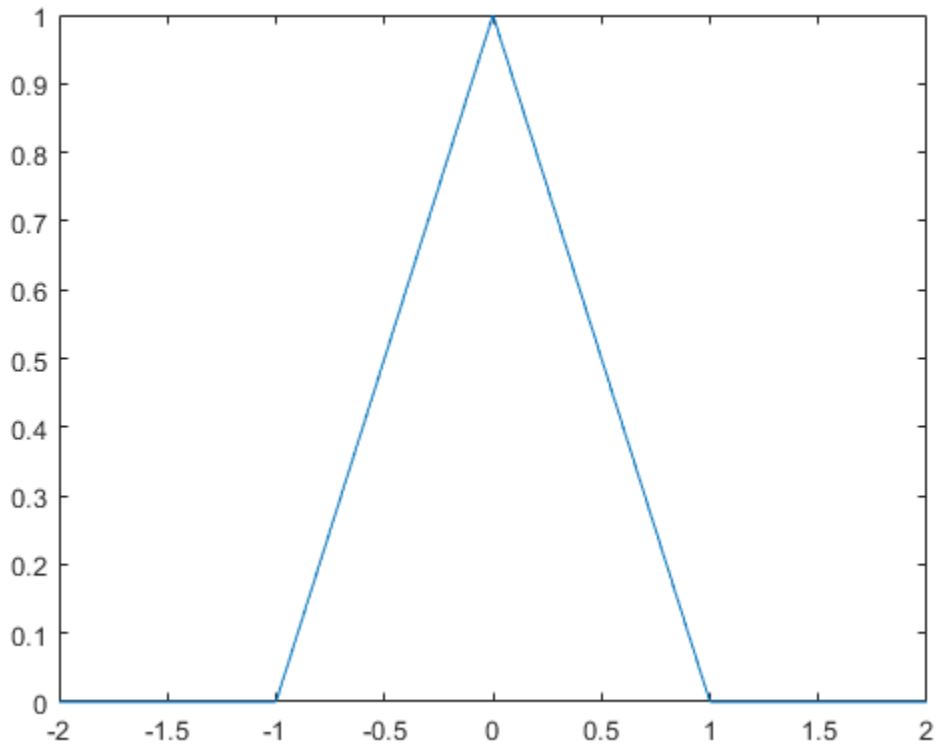

Compute Triangular Pulse Function

Compute the triangular pulse function for these numbers. Because these numbers are not symbolic objects, you get floating-point results.

```
[triangularPulse(-2, 0, 2, -3)
triangularPulse(-2, 0, 2, -1/2)
triangularPulse(-2, 0, 2, 0)
triangularPulse(-2, 0, 2, 3/2)
triangularPulse(-2, 0, 2, 3)]]
```

```
ans =
    0
    0.7500
    1.0000
    0.2500
    0
```

Compute the same values symbolically by converting the numbers to symbolic objects.

```
[triangularPulse(sym(-2), 0, 2, -3)
triangularPulse(-2, 0, 2, sym(-1/2))
triangularPulse(-2, sym(0), 2, 0)
triangularPulse(-2, 0, 2, sym(3/2))
triangularPulse(-2, 0, sym(2), 3)]]
```

```
ans =  
0  
3/4  
1  
1/4  
0
```

Fixed-Form Triangular Pulse of Width 2

Use `triangularPulse` with one input argument as a shortcut for computing `triangularPulse(-1, 0, 1, x)`:

```
syms x  
triangularPulse(x)  
  
ans =  
triangularPulse(-1, 0, 1, x)
```

Symmetrical Triangular Pulse

Use `triangularPulse` with three input arguments as a shortcut for computing `triangularPulse(a, (a + c)/2, c, x)`:

```
syms a c x  
triangularPulse(a, c, x)  
  
ans =  
triangularPulse(a, a/2 + c/2, c, x)
```

Special Cases of Triangular Pulse Function

Depending on the relation between inputs, the `triangularPulse` has special values.

Compute the triangular pulse function for $a < x < b$:

```
syms a b c x  
assume(a < x < b)  
triangularPulse(a, b, c, x)  
  
ans =  
(a - x)/(a - b)
```

For further computations, remove the assumption by recreating the variables using `syms`:

```
syms a b x
```

Compute the triangular pulse function for $b < x < c$:

```
assume(b < x < c)  
triangularPulse(a, b, c, x)  
  
ans =  
-(c - x)/(b - c)
```

For further computations, remove the assumption:

```
syms b c x
```

Compute the triangular pulse function for $a = b$:

```
syms a b c x
assume(b < c)
triangularPulse(b, b, c, x)

ans =
-((c - x)*rectangularPulse(b, c, x))/(b - c)
```

Compute the triangular pulse function for $c = b$:

```
assume(a < b)
triangularPulse(a, b, b, x)

ans =
((a - x)*rectangularPulse(a, b, x))/(a - b)
```

For further computations, remove all assumptions on a , b , and c :

```
syms a b c
```

Input Arguments

a — Input

-1 (default) | number | symbolic scalar

Input, specified as a number or a symbolic scalar. This argument specifies the rising edge of the triangular pulse function.

b — Input

number | symbolic scalar

Input, specified as a number or a symbolic scalar. This argument specifies the peak of the triangular pulse function. If you specify a and c , then $(a + c)/2$. Otherwise, 0.

c — Input

1 (default) | number | symbolic scalar

Input, specified as a number or a symbolic scalar. This argument specifies the falling edge of the triangular pulse function.

x — Input

number | vector | matrix | array | symbolic number | symbolic variable | symbolic array | symbolic function | symbolic expression

Input, specified as a number, vector, matrix, or array, or a symbolic number, variable, array, function, or expression.

More About

Triangular Pulse Function

If $a < x < b$, then the triangular pulse function equals $(x - a)/(b - a)$.

If $b < x < c$, then the triangular pulse function equals $(c - x)/(c - b)$.

If $x \leq a$ or $x \geq c$, then the triangular pulse function equals 0.

The triangular pulse function is also called the triangle function, hat function, tent function, or sawtooth function.

Tips

- If a , b , and c are variables or expressions with variables, `triangularPulse` assumes that $a \leq b \leq c$. If a , b , and c are numerical values that do not satisfy this condition, `triangularPulse` throws an error.
- If $a = b = c$, `triangularPulse` returns 0.
- If $a = b$ or $b = c$, the triangular function can be expressed in terms of the rectangular function.

See Also

`dirac` | `heaviside` | `rectangularPulse`

Introduced in R2012b

tril

Return lower triangular part of symbolic matrix

Syntax

```
tril(A)
tril(A,k)
```

Description

`tril(A)` returns a triangular matrix that retains the lower part of the matrix `A`. The upper triangle of the resulting matrix is padded with zeros.

`tril(A,k)` returns a matrix that retains the elements of `A` on and below the k -th diagonal. The elements above the k -th diagonal equal to zero. The values $k = 0$, $k > 0$, and $k < 0$ correspond to the main, superdiagonals, and subdiagonals, respectively.

Examples

Lower Triangular Part of Symbolic Matrix

Display the matrix retaining only the lower triangle of the original symbolic matrix:

```
syms a b c
A = [a b c; 1 2 3; a + 1 b + 2 c + 3];
tril(A)
```

```
ans =
[ a,      0,      0]
[  1,     2,      0]
[ a + 1, b + 2, c + 3]
```

Triangular Matrix On and Below Specified Superdiagonal

Display the matrix that retains the elements of the original symbolic matrix on and below the first superdiagonal:

```
syms a b c
A = [a b c; 1 2 3; a + 1 b + 2 c + 3];
tril(A, 1)
```

```
ans =
[ a,      b,      0]
[  1,     2,     3]
[ a + 1, b + 2, c + 3]
```

Triangular Matrix On and Below Specified Subdiagonal

Display the matrix that retains the elements of the original symbolic matrix on and below the first subdiagonal:

```
syms a b c
A = [a b c; 1 2 3; a + 1 b + 2 c + 3];
tril(A, -1)
```

```
ans =
[      0,      0,  0]
[      1,      0,  0]
[ a + 1, b + 2,  0]
```

Input Arguments

A — Input

matrix | symbolic matrix

Input, specified as a numeric or symbolic matrix.

k — Diagonal

number | symbolic number

Diagonal, specified as a numeric or symbolic number.

See Also

diag | triu

Introduced before R2006a

triu

Return upper triangular part of symbolic matrix

Syntax

```
triu(A)
triu(A,k)
```

Description

`triu(A)` returns a triangular matrix that retains the upper part of the matrix `A`. The lower triangle of the resulting matrix is padded with zeros.

`triu(A,k)` returns a matrix that retains the elements of `A` on and above the k -th diagonal. The elements below the k -th diagonal equal to zero. The values $k = 0$, $k > 0$, and $k < 0$ correspond to the main, superdiagonals, and subdiagonals, respectively.

Examples

Upper Triangular Part of Symbolic Matrix

Display the matrix retaining only the upper triangle of the original symbolic matrix:

```
syms a b c
A = [a b c; 1 2 3; a + 1 b + 2 c + 3];
triu(A)
```

```
ans =
[ a, b,      c]
[ 0, 2,      3]
[ 0, 0, c + 3]
```

Triangular Matrix On and Above Specified Superdiagonal

Display the matrix that retains the elements of the original symbolic matrix on and above the first superdiagonal:

```
syms a b c
A = [a b c; 1 2 3; a + 1 b + 2 c + 3];
triu(A, 1)
```

```
ans =
[ 0, b, c]
[ 0, 0, 3]
[ 0, 0, 0]
```

Triangular Matrix On and Above Specified Subdiagonal

Display the matrix that retains the elements of the original symbolic matrix on and above the first subdiagonal:

```
syms a b c
A = [a b c; 1 2 3; a + 1 b + 2 c + 3];
triu(A, -1)

ans =
[ a,      b,      c]
[ 1,      2,      3]
[ 0, b + 2, c + 3]
```

Input Arguments

A — Input

matrix | symbolic matrix

Input, specified as a numeric or symbolic matrix.

k — Diagonal

number | symbolic number

Diagonal, specified as a numeric or symbolic number.

See Also

diag | tril

Introduced before R2006a

unitConversionFactor

Conversion factor between units

Syntax

```
C = unitConversionFactor(unit1,unit2)
C = unitConversionFactor(unit1,unit2,'Force',true)
```

Description

`C = unitConversionFactor(unit1,unit2)` returns the conversion factor `C` between units `unit1` and `unit2` so that `unit1 = C*unit2`.

`C = unitConversionFactor(unit1,unit2,'Force',true)` forces `unitConversionFactor` to return a conversion factor even if the units are not dimensionally compatible.

Examples

Conversion Factor Between Units

Find the conversion factor between inches and centimeters.

```
u = symunit;
inch2cm = unitConversionFactor(u.inch,u.cm)

inch2cm =
127/50
```

Convert the conversion factor to double.

```
inch2cm = double(inch2cm)

inch2cm =
    2.5400
```

Find the conversion factor between Newtons and kg m/s². The conversion factor is 1.

```
convFactor = unitConversionFactor(1*u.N, 1*u.kg*u.m/u.s^2)

convFactor =
1
```

Convert Between Units

Convert between units quickly by using text input as a shortcut. Convert 3 inch to cm.

```
3*double(unitConversionFactor("inch","cm"))
```

```
ans =  
    7.6200
```

Convert Between Dimensionally Incompatible Units

Convert between dimensionally incompatible units by specifying the argument 'Force' as true.

Convert between Watts and Joules. `unitConversionFactor` returns the factor 1/[s] because 1 W = 1 J/s.

```
u = symunit;  
convFactor = unitConversionFactor(u.W, u.J, 'Force', true)  
  
convFactor =  
1/[s]
```

If you do not specify 'Force' as true, then `unitConversionFactor` returns an error.

```
unitConversionFactor(u.W, u.J)
```

```
Error using unitConversionFactor (line 81)  
Incompatible units.
```

Input Arguments

unit – Units

character vector | string | symbolic units

Units, specified as a character vector, string, or symbolic units.

See Also

`checkUnits` | `findUnits` | `isUnit` | `newUnit` | `separateUnits` | `str2symunit` | `symunit` | `symunit2str`

Topics

“Units of Measurement Tutorial” on page 2-19
“Unit Conversions and Unit Systems” on page 2-39
“Units and Unit Systems List” on page 2-25

External Websites

The International System of Units (SI)

Introduced in R2017a

unitConvert

Convert units to other units of measurement

Syntax

```
unitConvert(expr,units)
unitConvert(expr,unitSystem)
unitConvert(expr,unitSystem,'Derived')

___ = unitConvert( ___, 'Temperature', convMode)
```

Description

`unitConvert(expr,units)` converts symbolic units in the expression `expr` to the units `units`, where `units` can be a compound unit or a vector of units.

`unitConvert(expr,unitSystem)` converts `expr` to the unit system `unitSystem`. By default, the SI, CGS, and US unit systems are available. You can also define custom unit systems by using `newUnitSystem`.

`unitConvert(expr,unitSystem,'Derived')` converts units to derived units of `unitSystem`.

`___ = unitConvert(___, 'Temperature', convMode)` indicates whether temperatures represent absolute temperatures or temperature differences by specifying `'absolute'` or `'difference'` respectively, using input arguments in the previous syntaxes. The `'Temperature'` argument affects only conversion between units of temperature. By default, temperatures are assumed to be differences.

Examples

Convert Between Units

Convert 5 cm to inches. Because the calculation is symbolic, `unitConvert` returns a symbolic fractional result.

```
u = symunit;
length = unitConvert(5*u.cm,u.in)

length =
(250/127)*[in]
```

If conversion is not possible, `unitConvert` returns the input.

Convert `length` to floating point by separating the value using `separateUnits` and converting using `double`. Alternatively, keep the units by using `vpa` instead of `double`.

```
double(separateUnits(length))

ans =
    1.9685
```

```
vpa(length)
```

```
ans =  
1.968503937007874015748031496063*[in]
```

For more complex workflows, see “Unit Conversions and Unit Systems” on page 2-39.

Calculate the force required to accelerate 2 kg by 5 m/s². The result is not automatically in newtons.

```
m = 2*u.kg;  
a = 5*u.m/u.s^2;  
F = m*a
```

```
F =  
10*([kg]*[m])/[s]^2)
```

Convert F to newtons by using `unitConvert`.

```
F = unitConvert(F,u.N)
```

```
F =  
10*[N]
```

Specify Compound Unit for Conversion

Convert 5 km per hour to meters per second by specifying meters per second as a compound unit.

```
u = symunit;  
unitConvert(5*u.km/u.hr,u.m/u.s)
```

```
ans =  
(25/18)*([m]/[s])
```

Specify Multiple Units for Conversion

Specify multiple units for conversion by specifying the second argument as a vector of units. This syntax lets you specify units for every dimension to get the desired units.

Convert 5 km per hour to centimeters per minute.

```
u = symunit;  
f = 5*u.km/u.hr;  
units = [u.cm u.min];  
unitConvert(f,units)
```

```
ans =  
(25000/3)*([cm]/[min])
```

Convert Units to Unit System

Instead of converting to specific units, you can convert to units of a unit system, such as SI, CGS, or US.

Convert 5 meters to the 'US' unit system. `unitConvert` returns the result in feet.

```
u = symunit;  
unitConvert(5*u.m,'US')
```



```
ans =
(6250/381)*[ft]
```

Convert 10 newtons to derived units in CGS by using the input 'Derived'. The result is in dynes. Repeat the conversion without the input 'Derived' to get a result in base units.

```
F = 10*u.N;
cgsDerived = unitConvert(F,'CGS','Derived')
```

```
cgsDerived =
1000000*[dyn]
```

```
cgsBase = unitConvert(F,'CGS')
```

```
cgsBase =
1000000*([cm]*[g])/[s]^2)
```

Convert Temperature to Absolute and Difference Forms

By default, temperatures are assumed to represent temperature differences. For example, $5*u.Celsius$ represents a temperature difference of 5 degrees Celsius. This assumption allows arithmetical operations on temperature values and conversion between temperature scales.

To represent absolute temperatures, use degrees Kelvin so that you do not have to distinguish an absolute temperature from a temperature difference.

Convert 23 degrees Celsius to Kelvin, treating the temperature first as a temperature difference and then as an absolute temperature.

```
u = symunit;
T = 23*u.Celsius;
diffK = unitConvert(T,u.K)
```

```
diffK =
23*[K]
```

```
absK = unitConvert(T,u.K,'Temperature','absolute')
```

```
absK =
(5923/20)*[K]
```

Input Arguments

expr — Input

symbolic number | symbolic variable | symbolic expression | symbolic function | symbolic vector | symbolic matrix | symbolic multidimensional array

Input, specified as a symbolic number, variable, expression, function, or array.

units — Units to convert input to

symbolic unit | vector of symbolic units

Units to convert input to, specified as a symbolic unit or an array of symbolic units.

unitSystem — Unit system to convert input to

string | character vector

Unit system to convert input to, specified as a string or character vector. By default, the SI, CGS, and US unit systems are available. You can also define custom unit systems. See “Unit Conversions and Unit Systems” on page 2-39.

convMode — Temperature conversion mode

'difference' (default) | 'absolute'

Temperature conversion mode, specified as 'difference' or 'absolute'.

See Also

baseUnits | derivedUnits | newUnit | newUnitSystem | symunit

Topics

“Units of Measurement Tutorial” on page 2-19

“Units and Unit Systems List” on page 2-25

External Websites

The International System of Units (SI)

Introduced in R2018b

unitInfo

Information on units of measurement

Syntax

```
unitInfo(unit)
unitInfo(dim)
unitInfo
```

```
A = unitInfo( ___ )
```

Description

`unitInfo(unit)` returns information for the symbolic unit `unit`.

`unitInfo(dim)` returns available units for the dimension `dim`.

`unitInfo` returns a list of available physical dimensions.

`A = unitInfo(___)` returns the output in `A` using any of the input arguments in the previous syntaxes. Dimensions are returned as strings, and units are returned as symbolic units.

Examples

Find Information on Units and Dimensions

Find information on unit `u.Wb` where `u = symunit`. The `unitInfo` function specifies that `Wb` is the SI unit of magnetic flux.

```
u = symunit;
unitInfo(u.Wb)
```

```
weber - a physical unit of magnetic flux. ['SI']
```

```
Get all units for measuring 'MagneticFlux' by calling unitInfo('MagneticFlux').
SI units accept all SI prefixes. For details, see SI Unit Prefixes List.
```

Find all available units for 'MagneticFlux' as described.

```
unitInfo('MagneticFlux')
```

```
All units of dimension 'MagneticFlux':
```

```
abWb - abweber
Mx - maxwell
phi_0 - magnetic flux quantum
statWb - statweber
Wb - weber ['SI']
```

```
Get the base SI units of any unit above by calling rewrite(<unit>,'SI').
SI units accept all SI prefixes. For details, see SI Unit Prefixes List.
```

`unitInfo` also returns information on compound units. Find information on `u.m/u.s^2`.

```
unitInfo(u.m/u.s^2)
```

meter per square second - a physical unit of acceleration. ['SI']

Get all units for measuring 'Acceleration' by calling `unitInfo('Acceleration')`. SI units accept all SI prefixes. For details, see [SI Unit Prefixes List](#).

Find All Physical Dimensions Available

Return all available dimensions using `unitInfo` without input arguments.

```
unitInfo
```

```
"AbsorbedDose"  
"AbsorbedDoseOrDoseEquivalent"  
"AbsorbedDoseRate"  
"Acceleration"  
...  
...  
"Length"  
"Luminance"  
"LuminousEfficacy"  
...  
...  
"Torque"  
"Velocity"  
"Volume"
```

Use Information on Units and Dimensions

Store information returned by `unitInfo` for use by providing an output.

Store the dimension of `u.C`.

```
u = symunit;  
dimC = unitInfo(u.C)
```

```
dimC =  
    "ElectricCharge"
```

Find and store all units for the dimension `dimC`.

```
unitsEC = unitInfo(dimC)
```

```
unitsEC =  
    [abC]  
    [C]  
    [e]  
    [Fr]  
    [statC]
```

Find information on the third unit of `unitsEC`.

```
unitInfo(unitsEC(3))
```

unitSystems

List available unit systems

Syntax

```
unitSystems
```

Description

`unitSystems` returns a row vector of available unit systems.

- To add custom unit systems, see `newUnitSystem`.
- To convert between unit systems, see “Unit Conversions and Unit Systems” on page 2-39.
- For available unit systems, see “Unit Systems List” on page 2-36.

Examples

Get Available Unit Systems

Get available unit systems by using `unitSystems`. Add a custom unit system and check that `unitSystems` lists it as available.

Find the unit systems available by default.

```
unitSystems

ans =
    1×6 string array
    "CGS"    "EMU"    "ESU"    "GU"    "SI"    "US"
```

Add a custom unit system that modifies the SI base units. For details, see `newUnitSystem` and “Unit Conversions and Unit Systems” on page 2-39.

```
u = symunit;
SIUnits = baseUnits('SI');
newUnits = subs(SIUnits,[u.m u.s],[u.km u.hr]);
newUnitSystem('SI_km_hr',newUnits)

ans =
    "SI_km_hr"
```

Check that the new unit system is available by using `unitSystems`.

```
unitSystems

ans =
    1×7 string array
    "CGS"    "EMU"    "ESU"    "GU"    "SI"    "SI_km_hr"    "US"
```

After calculations, remove the new unit system and check that it is unavailable.

```
removeUnitSystem('SI_km_hr');
unitSystems

ans =
    1×6 string array
    "CGS"    "EMU"    "ESU"    "GU"    "SI"    "US"
```

See Also

[baseUnits](#) | [derivedUnits](#) | [newUnitSystem](#) | [removeUnitSystem](#) | [rewrite](#) | [symunit](#)

Topics

“Units of Measurement Tutorial” on page 2-19
“Unit Conversions and Unit Systems” on page 2-39
“Units and Unit Systems List” on page 2-25

External Websites

The International System of Units (SI)

Introduced in R2017b

vectorPotential

Vector potential of vector field

Syntax

```
vectorPotential(V,X)
vectorPotential(V)
```

Description

`vectorPotential(V,X)` computes the vector potential of the vector field on page 4-1419 V with respect to the vector X in Cartesian coordinates. The vector field V and the vector X are both three-dimensional.

`vectorPotential(V)` returns the vector potential V with respect to a vector constructed from the first three symbolic variables found in V by `symvar`.

Examples

Compute Vector Potential of Field

Compute the vector potential of this row vector field with respect to the vector $[x, y, z]$:

```
syms x y z
vectorPotential([x^2*y, -1/2*y^2*x, -x*y*z], [x y z])
```

```
ans =
  -(x*y^2*z)/2
  -x^2*y*z
  0
```

Compute the vector potential of this column vector field with respect to the vector $[x, y, z]$:

```
syms x y z
f(x,y,z) = 2*y^3 - 4*x*y;
g(x,y,z) = 2*y^2 - 16*z^2+18;
h(x,y,z) = -32*x^2 - 16*x*y^2;
A = vectorPotential([f; g; h], [x y z])
```

```
A(x, y, z) =
  z*(2*y^2 + 18) - (16*z^3)/3 + (16*x*y*(y^2 + 6*x))/3
  2*y*z*(- y^2 + 2*x)
  0
```

Test if Vector Potential Exists for Field

To check whether the vector potential exists for a particular vector field, compute the divergence of that vector field:

```
syms x y z
V = [x^2 2*y z];
divergence(V, [x y z])
```



```
ans =
2*x + 3
```

If the divergence is not equal to 0, the vector potential does not exist. In this case, `vectorPotential` returns the vector with all three components equal to NaN:

```
vectorPotential(V, [x y z])
```

```
ans =
NaN
NaN
NaN
```

Input Arguments

V — Vector field

3-D symbolic vector of symbolic expressions or functions (default)

Vector field, specified as a 3-D vector of symbolic expressions or functions.

X — Input

vector of three symbolic variables

Input, specified as a vector of three symbolic variables with respect to which you compute the vector potential.

More About

Vector Potential of a Vector Field

The vector potential of a vector field V is a vector field A , such that:

$$V = \nabla \times A = \text{curl}(A)$$

Tips

- The vector potential exists if and only if the divergence of a vector field V with respect to X equals 0. If `vectorPotential` cannot verify that V has a vector potential, it returns the vector with all three components equal to NaN.

See Also

`curl` | `diff` | `divergence` | `gradient` | `hessian` | `jacobian` | `laplacian` | `potential`

Introduced in R2012a

vertcat

Concatenate symbolic arrays vertically

Syntax

```
vertcat(A1,...,AN)  
[A1;...;AN]
```

Description

`vertcat(A1,...,AN)` vertically concatenates the symbolic arrays A_1, \dots, A_N . For vectors and matrices, all inputs must have the same number of columns. For multidimensional arrays, `vertcat` concatenates inputs along the first dimension. The remaining dimensions must match.

`[A1;...;AN]` is a shortcut for `vertcat(A1,...,AN)`.

Examples

Concatenate Two Symbolic Vectors Vertically

Concatenate the two symbolic vectors A and B to form a symbolic matrix.

```
A = sym('a%d',[1 4]);  
B = sym('b%d',[1 4]);  
vertcat(A,B)
```

```
ans =  
[ a1, a2, a3, a4]  
[ b1, b2, b3, b4]
```

Alternatively, you can use the shorthand `[A;B]` to concatenate A and B .

```
[A;B]
```

```
ans =  
[ a1, a2, a3, a4]  
[ b1, b2, b3, b4]
```

Concatenate Multiple Symbolic Arrays Vertically

Concatenate multiple symbolic arrays into one symbolic matrix.

```
A = sym('a%d',[1 3]);  
B = sym('b%d%d',[4 3]);  
C = sym('c%d%d',[2 3]);  
vertcat(C,A,B)
```

```
ans =  
[ c11, c12, c13]  
[ c21, c22, c23]  
[ a1, a2, a3]  
[ b11, b12, b13]  
[ b21, b22, b23]
```

```
[ b31, b32, b33]
[ b41, b42, b43]
```

Concatenate Multidimensional Arrays Vertically

Create the 3-D symbolic arrays A and B.

```
A = [2 4; 1 7; 3 3];
A(:,:,2) = [8 9; 4 5; 6 2];
A = sym(A)
B = [8 3; 0 2];
B(:,:,2) = [6 2; 3 3];
B = sym(B)
```

```
A(:,:,1) =
[ 2, 4]
[ 1, 7]
[ 3, 3]
A(:,:,2) =
[ 8, 9]
[ 4, 5]
[ 6, 2]
```

```
B(:,:,1) =
[ 8, 3]
[ 0, 2]
B(:,:,2) =
[ 6, 2]
[ 3, 3]
```

Use `vertcat` to concatenate A and B.

```
vertcat(A,B)
```

```
ans(:,:,1) =
[ 2, 4]
[ 1, 7]
[ 3, 3]
[ 8, 3]
[ 0, 2]
```

```
ans(:,:,2) =
[ 8, 9]
[ 4, 5]
[ 6, 2]
[ 6, 2]
[ 3, 3]
```

Input Arguments

A1, ..., AN — Input arrays

symbolic variable | symbolic vector | symbolic matrix | symbolic multidimensional array

Input arrays, specified as symbolic variables, vectors, matrices, or multidimensional arrays.

See Also

`cat` | `horzcat`

Introduced before R2006a

```
[
                                0,    0.80901699437494742410229341718282]
[ exp(3.1415926535897932384626433832795*x), 0.87356852683023186835397746476334*x]
```

Note You must wrap all inner inputs with `vpa`, such as `exp(vpa(200))`. Otherwise the inputs are automatically converted to double by MATLAB.

Change Precision Used by `vpa`

By default, `vpa` evaluates inputs to 32 significant digits. You can change the number of significant digits by using the `digits` function.

Approximate the expression $100001/10001$ with seven significant digits using `digits`. Save the old value of `digits` returned by `digits(7)`. The `vpa` function returns only five significant digits, which can mean the remaining digits are zeros.

```
digitsOld = digits(7);
y = sym(100001)/10001;
vpa(y)
```

```
ans =
9.9991
```

Check if the remaining digits are zeros by using a higher precision value of 25. The result shows that the remaining digits are in fact a repeating decimal.

```
digits(25)
vpa(y)
```

```
ans =
9.99910008999910008999910009
```

Alternatively, to override `digits` for a single `vpa` call, change the precision by specifying the second argument.

Find π to 100 significant digits by specifying the second argument.

```
vpa(pi,100)
```

```
ans =
3.141592653589793238462643383279502884197169...
39937510582097494459230781640628620899862803...
4825342117068
```

Restore the original precision value in `digitsOld` for further calculations.

```
digits(digitsOld)
```

Numerically Approximate Symbolic Results

While symbolic results are exact, they might not be in a convenient form. You can use `vpa` to numerically approximate exact symbolic results.

Solve a high-degree polynomial for its roots using `solve`. The `solve` function cannot symbolically solve the high-degree polynomial and represents the roots using `root`.

```
syms x
y = solve(x^4 - x + 1, x)
```



```
ans =
0.0
```

Input Arguments

x — Input to evaluate

number | vector | matrix | multidimensional array | symbolic number | symbolic vector | symbolic matrix | symbolic multidimensional array | symbolic expression | symbolic function | symbolic character vector

Input to evaluate, specified as a number, vector, matrix, multidimensional array, or a symbolic number, vector, matrix, multidimensional array, expression, function, or character vector.

d — Number of significant digits

integer

Number of significant digits, specified as an integer. d must be greater than 1 and lesser than $2^{29} + 1$.

Tips

- `vpa` does not convert fractions in the exponent to floating point. For example, `vpa(a^sym(2/5))` returns $a^{(2/5)}$.
- `vpa` uses more digits than the number of digits specified by `digits`. These extra digits guard against round-off errors in subsequent calculations and are called guard digits.
- When you call `vpa` on a numeric input, such as $1/3$, $2^{(-5)}$, or $\sin(\pi/4)$, the numeric expression is evaluated to a double-precision number that contains round-off errors. Then, `vpa` is called on that double-precision number. For accurate results, convert numeric expressions to symbolic expressions with `sym`. For example, to approximate $\exp(1)$, use `vpa(exp(sym(1)))`.
- If the second argument `d` is not an integer, `vpa` rounds it to the nearest integer with `round`.
- `vpa` restores precision for numeric inputs that match the forms p/q , $p\pi/q$, $(p/q)^{1/2}$, 2^q , and 10^q , where p and q are modest-sized integers.
- Atomic operations using variable-precision arithmetic round to nearest.
- The differences between variable-precision arithmetic and IEEE Floating-Point Standard 754 are
 - Inside computations, division by zero throws an error.
 - The exponent range is larger than in any predefined IEEE mode. `vpa` underflows below approximately $10^{(-323228496)}$.
 - Denormalized numbers are not implemented.
 - Zeroes are not signed.
 - The number of *binary* digits in the mantissa of a result may differ between variable-precision arithmetic and IEEE predefined types.
 - There is only one NaN representation. No distinction is made between quiet and signaling NaN.
 - No floating-point number exceptions are available.

See Also

`digits` | `double` | `root` | `vpaintegral`

Topics

“Increase Precision of Numeric Calculations” on page 2-128

“Recognize and Avoid Round-Off Errors” on page 2-130

“Increase Speed by Reducing Precision” on page 2-134

“Choose Numeric or Symbolic Arithmetic” on page 2-124

Introduced before R2006a

vpaintegral

Numerical integration using variable precision

Syntax

```
vpaintegral(f,a,b)
vpaintegral(f,x,a,b)
vpaintegral( ___,Name,Value)
```

Description

`vpaintegral(f,a,b)` numerically approximates `f` from `a` to `b`. The default variable `x` in `f` is found by `symvar`.

`vpaintegral(f,[a b])` is equal to `vpaintegral(f,a,b)`.

`vpaintegral(f,x,a,b)` performs numerical integration using the integration variable `x`.

`vpaintegral(___,Name,Value)` uses additional options specified by one or more `Name,Value` pair arguments.

Examples

Numerically Integrate Symbolic Expression

Numerically integrate the symbolic expression x^2 from 1 to 2.

```
syms x
vpaintegral(x^2, 1, 2)
```

```
ans =
2.33333
```

Numerically Integrate Symbolic Function

Numerically integrate the symbolic function $y(x) = x^2$ from 1 to 2.

```
syms y(x)
y(x) = x^2;
vpaintegral(y, 1, 2)
```

```
ans =
2.33333
```

High-Precision Numerical Integration

`vpaintegral` uses variable-precision arithmetic while the MATLAB `integral` function uses double-precision arithmetic. Using the default values of tolerance, `vpaintegral` can handle values that cause the MATLAB `integral` function to overflow or underflow.

Integrate `besseli(5,25*u).*exp(-u*25)` by using both `integral` and `vpaintegral`. The `integral` function returns NaN and issues a warning while `vpaintegral` returns the correct result.

```

syms u x
f = besseli(5,25*x).*exp(-x*25);
fun = @(u)besseli(5,25*u).*exp(-u*25);

usingIntegral = integral(fun, 0, 30)
usingVpintegral = vpaintegral(f, 0, 30)

Warning: Infinite or Not-a-Number value encountered.
usingIntegral =
    NaN

usingVpintegral =
    0.688424

```

Increase Precision Using Tolerances

The `digits` function does not affect `vpaintegral`. Instead, increase the precision of `vpaintegral` by decreasing the integration tolerances. Conversely, increase the speed of numerical integration by increasing the tolerances. Control the tolerance used by `vpaintegral` by changing the relative tolerance `RelTol` and absolute tolerance `AbsTol`, which affect the integration through the condition

$$|Q - I| \leq \max(\text{AbsTol}, |Q| \cdot \text{RelTol})$$

where Q = Calculated Integral
 I = Exact Integral.

Numerically integrate `besselj(0,x)` from 0 to π , to 32 significant figures by setting `RelTol` to $10^{(-32)}$. Turn off `AbsTol` by setting it to 0.

```

syms x
vpaintegral(besselj(0,x), [0 pi], 'RelTol', 1e-32, 'AbsTol', 0)

ans =
1.3475263146739901712314731279612

```

Using lower tolerance values increases precision at the cost of speed.

Complex Path Integration Using Waypoints

Integrate $1/(2z-1)$ over the triangular path from 0 to $1+i$ to $1-i$ back to 0 by specifying waypoints.

```

syms z
vpaintegral(1/(2*z-1), [0 0], 'Waypoints', [1+i 1-i])

ans =
- 8.67362e-19 - 3.14159i

```

Reversing the direction of the integral, by changing the order of the waypoints and exchanging the limits, changes the sign of the result.

Multiple Integrals

Perform multiple integration by nesting calls to `vpaintegral`. Integrate

$$\int_{-1}^2 \int_1^3 xy \, dx \, dy.$$

```
syms x y
vpaintegral(vpaintegral(x*y, x, [1 3]), y, [-1 2])
```

```
ans =
6.0
```

The limits of integration can be symbolic expressions or functions. Integrate over the triangular region $0 \leq x \leq 1$ and $|y| < x$ by specifying the limits of the integration over y in terms of x .

```
vpaintegral(vpaintegral(sin(x-y)/(x-y), y, [-x x]), x, [0 1])
```

```
ans =
0.89734
```

Input Arguments

f — Expression or function to integrate

symbolic number | symbolic variable | symbolic vector | symbolic matrix | symbolic multidimensional array | symbolic function | symbolic expression

Expression or function to integrate, specified as a symbolic number, variable, vector, matrix, multidimensional array, function, or expression.

a, b — Limits of integration

list of two numbers | list of two symbolic numbers | list of two symbolic variables | list of two symbolic functions | list of two symbolic expressions

Limits of integration, specified as a list of two numbers, symbolic numbers, symbolic variables, symbolic functions, or symbolic expressions.

x — Integration variable

symbolic variable

Integration variable, specified as a symbolic variable. If x is not specified, the integration variable is found by `symvar`.

Name-Value Pair Arguments

Specify optional comma-separated pairs of `Name, Value` arguments. `Name` is the argument name and `Value` is the corresponding value. `Name` must appear inside quotes. You can specify several name and value pair arguments in any order as `Name1, Value1, ..., NameN, ValueN`.

Example: `'RelTol', 1e-20`

RelTol — Relative error tolerance

1e-6 (default) | positive real number

Relative error tolerance, specified as a positive real number. The default is `1e-6`. The `RelTol` argument determines the accuracy of the integration only if $RelTol \cdot |Q| > AbsTol$, where Q is the calculated integral. In this case, `vpaintegral` satisfies the condition $|Q - I| \leq RelTol \cdot |Q|$, where I is the exact integral value. To use only `RelTol` and turn off `AbsTol`, set `AbsTol` to `0`.

Example: `1e-8`

AbsTol — Absolute error tolerance

1e-10 (default) | non-negative real number

Absolute error tolerance, specified as a non-negative real number. The default is $1e-10$. `AbsTol` determines the accuracy of the integration if $AbsTol > RelTol \cdot |Q|$, where Q is the calculated integral. In this case, `vpaintegral` satisfies the condition $|Q - I| \leq AbsTol$, where I is the exact integral value. To turn off `AbsTol` and use only `RelTol`, set `AbsTol` to 0 .

Example: $1e-12$

Waypoints – Integration path

vector of numbers | vector of symbolic numbers | vector of symbolic expressions | vector of symbolic functions

Integration path, specified as a vector of numbers, or as a vector of symbolic numbers, expressions, or functions. `vpaintegral` integrates along the sequence of straight-line paths (lower limit to the first waypoint, from the first to the second waypoint, and so on) and finally from the last waypoint to the upper limit. For contour integrals, set equal lower and upper limits and define the contour using waypoints.

MaxFunctionCalls – Maximum evaluations of input

10^5 (default) | positive integer | positive symbolic integer

Maximum evaluations of input, specified as a positive integer or a positive symbolic integer. The default value is 10^5 . If the number of evaluations of f is greater than `MaxFunctionCalls`, then `vpaintegral` throws an error. For unlimited evaluations, set `MaxFunctionCalls` to `Inf`.

Tips

- Ensure that the input is integrable. If the input is not integrable, the output of `vpaintegral` is unpredictable.
- The `digits` function does not affect `vpaintegral`. To increase precision, use the `RelTol` and `AbsTol` arguments instead.

See Also

`diff` | `int` | `integral` | `vpa`

Topics

“Integration” on page 2-59

Introduced in R2016b

vpasolve

Solve equations numerically

Syntax

```
S = vpasolve(eqn,var)
S = vpasolve(eqn,var,init_param)

Y = vpasolve(eqns,vars)
Y = vpasolve(eqns,vars,init_param)

[y1,...,yN] = vpasolve(eqns,vars)
[y1,...,yN] = vpasolve(eqns,vars,init_param)

___ = vpasolve( ___, 'Random', true)
```

Description

`S = vpasolve(eqn,var)` numerically solves the equation `eqn` for the variable `var`. If you do not specify `var`, `vpasolve` solves for the default variable determined by `symvar`. For example, `vpasolve(x + 1 == 2, x)` numerically solves the equation $x + 1 = 2$ for x .

`S = vpasolve(eqn,var,init_param)` numerically solves the equation `eqn` for the variable `var` using the initial guess or search range `init_param`.

`Y = vpasolve(eqns,vars)` numerically solves the system of equations `eqns` for the variables `vars`. This syntax returns a structure array `Y` that contains the solutions. The fields in the structure array correspond to the variables specified by `vars`. If you do not specify `vars`, `vpasolve` solves for the default variables determined by `symvar`.

`Y = vpasolve(eqns,vars,init_param)` numerically solves the system of equations `eqns` for the variables `vars` using the initial guess or search range `init_param`.

`[y1,...,yN] = vpasolve(eqns,vars)` numerically solves the system of equations `eqns` for the variables `vars`. This syntax assigns the solutions to the variables `y1,...,yN`. If you do not specify `vars`, `vpasolve` solves for the default variables determined by `symvar`.

`[y1,...,yN] = vpasolve(eqns,vars,init_param)` numerically solves the system of equations `eqns` for the variables `vars` using the initial guess or search range `init_param`.

`___ = vpasolve(___, 'Random', true)` uses a random initial guess for finding solutions. Use this input to avoid returning the same solution repeatedly for nonpolynomial equations. If you specify initial guesses for all variables, setting 'Random' to true has no effect.

Examples

Solve Polynomial and Nonpolynomial Equations

Solve a polynomial equation. For polynomial equations, `vpasolve` returns all solutions.

```
syms x
S = vpsolve(2*x^4 + 3*x^3 - 4*x^2 - 3*x + 2 == 0, x)
```

```
S =
    (-2.0)
    (-1.0)
     0.5
     1.0
```

Solve a nonpolynomial equation. For nonpolynomial equations, `vpsolve` returns the first solution that it finds.

```
S = vpsolve(sin(x) == 1/2, x)
S = 0.52359877559829887307710723054658
```

Find Multiple Solutions by Specifying Initial Guesses

Find multiple solutions of the equation $200\sin(x) = x^3 - 1$ by specifying the initial guesses when using `vpsolve`.

Plot the left and right sides of the equation.

```
syms x
eqnLeft = 200*sin(x);
eqnRight = x^3 - 1;
fplot([eqnLeft eqnRight])
title([texlabel(eqnLeft) ' = ' texlabel(eqnRight)])
```

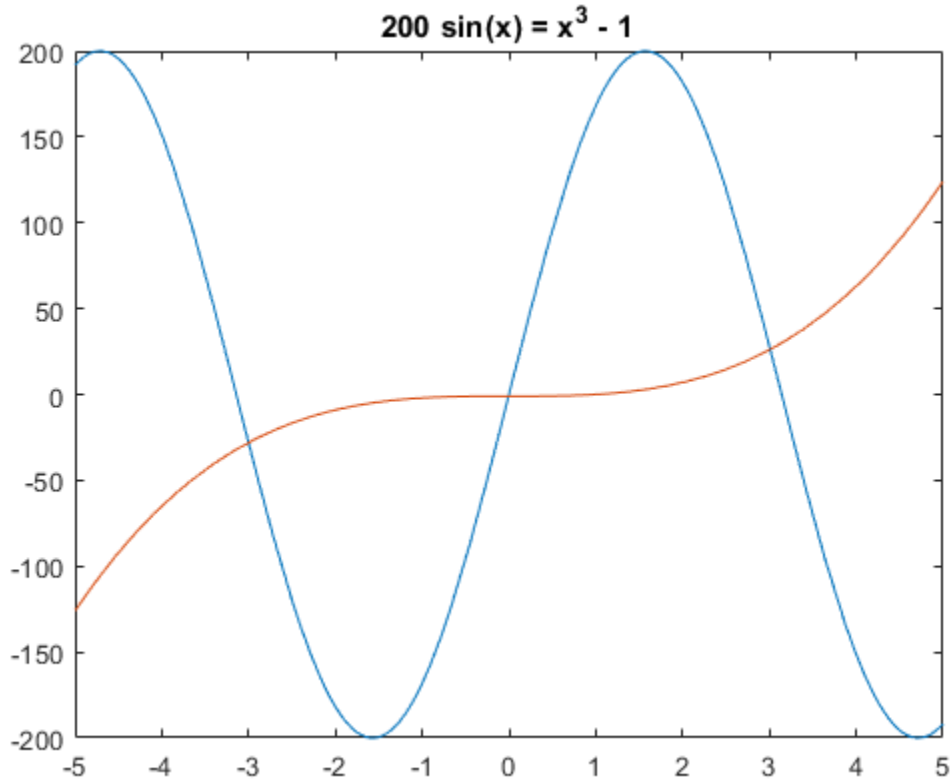
The plot shows that the equation has three solutions. If you do not specify the initial guess, `vpasolve` returns the first solution that it finds.

```
S1 = vpasolve(eqnLeft == eqnRight, x)
```

```
S1 = -0.00500000214585835715725440675982988
```

Find one of the other solutions by specifying an initial guess that is close to that solution.

```
S2 = vpasolve(eqnLeft == eqnRight, x, -3)
```

```
S2 = -3.0009954677086430679926572924945
```

```
S3 = vpasolve(eqnLeft == eqnRight, x, 4)
```

```
S3 = 3.0098746383859522384063444361906
```

Solve System of Equations

Solve a system of equations. Use one output argument to return the solutions in the form of a structure array.

```
syms u v
Y = vpasolve([v^3 + 2*u == v, v^2 == u], [u,v])
```

```
Y = struct with fields:
  u: [3x1 sym]
```

```
v: [3x1 sym]
```

Display the solutions by accessing the fields of the structure array Y.

```
uSol = Y.u
```

```
uSol =
      0
      5.8284271247461900976033774484194
      0.1715728752538099023966225515806
```

```
vSol = Y.v
```

```
vSol =
      0
      -2.4142135623730950488016887242097
      0.4142135623730950488016887242097
```

If `vpasolve` cannot find a solution, it returns an empty object.

```
syms x
eqns = [3*x+2, 3*x+1];
Y = vpasolve(eqns,x)
```

```
Y =
```

```
Empty sym: 0-by-1
```

Assign Solutions to Variables When Solving System of Equations

When solving a system of equations, use multiple output arguments to assign the solutions directly to output variables. The order in which the solver returns the solutions follows the order in which you specify the variables.

```
syms x y
[sol_x, sol_y] = vpasolve([x*sin(10*x) == y^3, y^2 == exp(-2*x/3)], [x,y])
sol_x = 88.90707209659114864849280774681
sol_y = 0.00000000000013470479710676694388973703681918
```

Specify Ranges of Solutions

You can specify ranges of solutions of an equation. For example, if you want to restrict your search to only real solutions, you cannot use assumptions because `vpasolve` ignores assumptions. Instead, specify a search interval. For the following equation, if you do not specify ranges, the numeric solver returns all six solutions of the equation.

```
syms x
S = vpasolve(x^6 - x^2 == 3, x)
```

$$S = \begin{pmatrix} -1.2929423350084724369196550436382 \\ 1.2929423350084724369196550436382 \\ -0.50188125716943915856832436499602 - 1.0429452224956770037495194222175 i \\ -0.50188125716943915856832436499602 + 1.0429452224956770037495194222175 i \\ 0.50188125716943915856832436499602 - 1.0429452224956770037495194222175 i \\ 0.50188125716943915856832436499602 + 1.0429452224956770037495194222175 i \end{pmatrix}$$

Suppose you need only real solutions of this equation. You cannot use assumptions on variables because `vpasolve` ignores them.

```
assume(x, 'real')
S = vpasolve(x^6 - x^2 == 3, x)
```

$$S = \begin{pmatrix} -1.2929423350084724369196550436382 \\ 1.2929423350084724369196550436382 \\ -0.50188125716943915856832436499602 - 1.0429452224956770037495194222175 i \\ -0.50188125716943915856832436499602 + 1.0429452224956770037495194222175 i \\ 0.50188125716943915856832436499602 - 1.0429452224956770037495194222175 i \\ 0.50188125716943915856832436499602 + 1.0429452224956770037495194222175 i \end{pmatrix}$$

Specify the search range to restrict the returned results to particular ranges. For example, to return only real solutions of this equation, specify the search interval as `[-Inf Inf]`.

```
S = vpasolve(x^6 - x^2 == 3, x, [-Inf Inf])
```

$$S = \begin{pmatrix} -1.2929423350084724369196550436382 \\ 1.2929423350084724369196550436382 \end{pmatrix}$$

To return nonnegative solutions, specify the search interval as `[0 Inf]`.

```
S = vpasolve(x^6 - x^2 == 3, x, [0 Inf])
```

```
S = 1.2929423350084724369196550436382
```

The search range can also contain complex numbers, such as `[-1, 1+2i]`. In this case, `vpasolve` uses a rectangular search area in the complex plane where `-1` specifies the bottom-left corner of the search area and `1+2i` specifies the top-right corner of that area.

```
S = vpasolve(x^6 - x^2 == 3, x, [-1 1+2i])
```

$$S = \begin{pmatrix} -0.50188125716943915856832436499602 + 1.0429452224956770037495194222175 i \\ 0.50188125716943915856832436499602 + 1.0429452224956770037495194222175 i \end{pmatrix}$$

Provide Initial Guess to Find Solutions

Find the solution for the following system of equations.

```
syms x y
eqn1 = exp(-x^2-y^2)*(x-4) - exp((-x^2-y^2)/2)*(x-2) == 0
```

```
eqn1 =
```

$$e^{-x^2-y^2} (x-4) - e^{-\frac{x^2}{2}-\frac{y^2}{2}} (x-2) = 0$$

```
eqn2 = exp(-x^2-y^2)*(y-2) - exp((-x^2-y^2)/2)*(y-4) == 0
```

```
eqn2 =
```

$$e^{-x^2-y^2} (y-2) - e^{-\frac{x^2}{2}-\frac{y^2}{2}} (y-4) = 0$$

Find the solution for the variables x and y without specifying initial guess. `vpasolve` cannot find a solution and it returns an empty object.

```
[solX, solY] = vpasolve([eqn1 eqn2],[x y])
```

```
solX =
```

```
Empty sym: 0-by-1
```

```
solY =
```

```
Empty sym: 0-by-1
```

Now specify the initial guesses $x = 2$ and $y = 4$. `vpasolve` returns the solutions that are close to the initial guesses.

```
[solX, solY] = vpasolve([eqn1 eqn2],[x y],[2; 4])
```

```
solX = 1.9999092125057125429174334656647
```

```
solY = 4.0000907874942874570825665343353
```

Find Multiple Solutions for Nonpolynomial Equation

By default, `vpasolve` returns the same solution on every call. To find more than one solution for nonpolynomial equations, set `'Random'` to `true`. This makes `vpasolve` use a random initial guess which can lead to different solutions on successive calls.

If `'Random'` is not specified, `vpasolve` returns the same solution on every call.

```
syms x
f = x-tan(x);
for n = 1:3
    S = vpasolve(f,x)
end
```

```
S = 0
```

```
S = 0
```

```
S = 0
```

When `'Random'` is set to `true`, `vpasolve` returns a distinct solution on every call.

```

for n = 1:3
    S = vpasolve(f,x,'Random',true)
end

S = -227.76107684764829218924973598808

S = 102.09196646490764333652956578441

S = 61.244730260374400372753016364097

```

The 'Random' option can be used in conjunction with a search range.

```

S = vpasolve(f,x,[10 12],'Random',true)

S = 10.904121659428899827148702790189

```

Input Arguments

eqn — Equation to solve

symbolic equation | symbolic expression

Equation to solve, specified as a symbolic equation or symbolic expression. A symbolic equation is defined by the relation operator `==`. If `eqn` is a symbolic expression (without the right side), the solver assumes that the right side is 0, and solves the equation `eqn == 0`.

var — Variable to solve equation for

symbolic variable

Variable to solve equation for, specified as a symbolic variable. If `var` is not specified, `symvar` determines the variables.

eqns — System of equations or expressions to solve

symbolic vector | symbolic matrix | symbolic array

System of equations or expressions to be solve, specified as a symbolic vector, matrix, or array of equations or expressions. These equations or expressions can also be separated by commas. If an equation is a symbolic expression (without the right side), the solver assumes that the right side of the equation is 0.

vars — Variables to solve system of equations for

symbolic vector

Variables to solve system of equations for, specified as a symbolic vector. These variables are specified as a vector or comma-separated list. If `vars` is not specified, `symvar` determines the variables.

init_param — Initial guess or search range for solution

numeric value | vector | matrix with two columns

Initial guess or search range for a solution, specified as a numeric value, vector, or matrix with two columns.

If `init_param` is a number or, in the case of multivariate equations, a vector of numbers, then the numeric solver uses it as an initial guess. If `init_param` is specified as a scalar while the system of equations is multivariate, then the numeric solver uses the scalar value as an initial guess for all

variables. For an example, see “Find Multiple Solutions by Specifying Initial Guesses” on page 4-1434.

If `init_param` is a matrix with two columns, then the two entries of the rows specify the bounds of an initial guess for the corresponding variables. To specify an initial guess in a matrix of search ranges, specify both columns as the initial guess value.

If you specify `init_param` as a search range `[a b]` and the values `a`, `b` are complex numbers, then `vpasolve` searches for the solutions in the rectangular search area in the complex plane. Here, `a` specifies the bottom-left corner of the rectangular search area, and `b` specifies the top-right corner of that area. For an example, see “Specify Ranges of Solutions” on page 4-1436.

To omit a search range for a variable, set the search range for that variable to `[NaN, NaN]` in `init_param`. All other uses of `NaN` in `init_param` will error.

Output Arguments

S — Solutions of univariate equation

symbolic value | symbolic array

Solutions of univariate equation, returned as symbolic value or symbolic array. The size of a symbolic array corresponds to the number of the solutions.

Y — Solutions of system of equations

structure array

Solutions of system of equations, returned as a structure array. The number of fields in the structure array corresponds to the number of variables to be solved for.

y1, . . . , yN — Variables that are assigned solutions of system of equations

array of numeric variables | array of symbolic variables

Variables that are assigned solutions of system of equations, returned as an array of numeric or symbolic variables. The number of output variables or symbolic arrays must equal the number of variables to be solved for. If you explicitly specify independent variables `vars`, then the solver uses the same order to return the solutions. If you do not specify `vars`, the toolbox sorts independent variables alphabetically, and then assigns the solutions for these variables to the output variables or symbolic arrays.

Tips

- If `vpasolve` cannot find a solution, it returns an empty object. Provide initial guess to help the solver finding a solution. For an example, see “Provide Initial Guess to Find Solutions” on page 4-1437.
- For polynomial equations, `vpasolve` returns all solutions. For nonpolynomial equations, there is no general method of finding all solutions and `vpasolve` returns only one solution by default. To find several different solutions for nonpolynomial, you can set `'Random'` to true and use `vpasolve` repeatedly.
- When you solve a system of equations with nonunique solutions, the behavior of `vpasolve` depends on whether the system is polynomial or nonpolynomial. If polynomial, `vpasolve` returns all solutions by introducing an arbitrary parameter. If nonpolynomial, a single numerical solution is returned, if it exists.

- When you solve a system of rational equations, `vpasolve` transforms the rational equations to polynomials by multiplying out the denominators. `vpasolve` returns all solutions of the resulting polynomial system, which also include the roots of the denominators.
- `vpasolve` ignores assumptions set on variables. You can restrict the returned results to particular ranges by specifying appropriate search ranges using the argument `init_param`.
- The output variables `y1, . . . , yN` do not specify the variables for which `vpasolve` solves equations or systems. If `y1, . . . , yN` are the variables that appear in `eqns`, that does not guarantee that `vpasolve(eqns)` will assign the solutions to `y1, . . . , yN` using the correct order. Thus, for the call `[a,b] = vpasolve(eqns)`, you might get the solutions for `a` assigned to `b` and vice versa.

To ensure the order of the returned solutions, specify the variables `vars`. For example, the call `[b,a] = vpasolve(eqns,[b,a])` assigns the solutions for `a` assigned to `a` and the solutions for `b` assigned to `b`.

- You can solve equations symbolically using `solve`, and then numerically approximate the results using `vpa`. Using this approach, you get numeric approximations of all solutions found by the symbolic solver. However, this can reduce computational speed since solving symbolically and postprocessing the results take more time than directly using the numeric solver `vpasolve`.

Algorithms

- When you set `'Random'` to `true` and specify a search range for a variable, random initial guesses within the search range are chosen using the internal random number generator (with uniform distribution).
- When you set `'Random'` to `true` and do not specify a search range for a variable, random initial guesses are generated using a Cauchy distribution with a half-width of `100`. This means the initial guesses are real valued and have a large spread of values on repeated calls.

See Also

`dsolve` | `equationsToMatrix` | `fzero` | `linsolve` | `solve` | `symvar` | `vpa`

Introduced in R2012b

whittakerM

Whittaker M function

Syntax

`whittakerM(a,b,z)`

Description

`whittakerM(a,b,z)` returns the value of the Whittaker M function on page 4-1444.

Examples

Compute Whittaker M Function for Numeric Input

Compute the Whittaker M function for these numbers. Because these numbers are not symbolic objects, you get floating-point results.

```
[whittakerM(1, 1, 1), whittakerM(-2, 1, 3/2 + 2*i),...
whittakerM(2, 2, 2), whittakerM(3, -0.3, 1/101)]
```

```
ans =
    0.7303          -9.2744 + 5.4705i    2.6328          0.3681
```

Compute Whittaker M Function for Symbolic Input

Compute the Whittaker M function for the numbers converted to symbolic objects. For most symbolic (exact) numbers, `whittakerM` returns unresolved symbolic calls.

```
[whittakerM(sym(1), 1, 1), whittakerM(-2, sym(1), 3/2 + 2*i),...
whittakerM(2, 2, sym(2)), whittakerM(sym(3), -0.3, 1/101)]
```

```
ans =
[ whittakerM(1, 1, 1), whittakerM(-2, 1, 3/2 + 2i),
whittakerM(2, 2, 2), whittakerM(3, -3/10, 1/101)]
```

For symbolic variables and expressions, `whittakerM` also returns unresolved symbolic calls:

```
syms a b x y
[whittakerM(a, b, x), whittakerM(1, x, x^2),...
whittakerM(2, x, y), whittakerM(3, x + y, x*y)]
```

```
ans =
[ whittakerM(a, b, x), whittakerM(1, x, x^2),...
whittakerM(2, x, y), whittakerM(3, x + y, x*y)]
```

Solve ODE for Whittaker Functions

Solve this second-order differential equation. The solutions are given in terms of the Whittaker functions.

```
syms a b w(z)
dsolve(diff(w, 2) + (-1/4 + a/z + (1/4 - b^2)/z^2)*w == 0)
```



```
ans =
C2*whittakerM(-a,-b,-z) + C3*whittakerW(-a,-b,-z)
```

Verify Whittaker Functions are Solution of ODE

Verify that the Whittaker M function is a valid solution of this differential equation:

```
syms a b z
isAlways(diff(whittakerM(a,b,z), z, 2) +...
(-1/4 + a/z + (1/4 - b^2)/z^2)*whittakerM(a,b,z) == 0)
```

```
ans =
    logical
     1
```

Verify that $\text{whittakerM}(-a, -b, -z)$ also is a valid solution of this differential equation:

```
syms a b z
isAlways(diff(whittakerM(-a,-b,-z), z, 2) +...
(-1/4 + a/z + (1/4 - b^2)/z^2)*whittakerM(-a,-b,-z) == 0)
```

```
ans =
    logical
     1
```

Compute Special Values of Whittaker M Function

The Whittaker M function has special values for some parameters:

```
whittakerM(sym(-3/2), 1, 1)
```

```
ans =
exp(1/2)
```

```
syms a b x
whittakerM(0, b, x)
```

```
ans =
4^b*x^(1/2)*gamma(b + 1)*besseli(b, x/2)
```

```
whittakerM(a + 1/2, a, x)
```

```
ans =
x^(a + 1/2)*exp(-x/2)*whittakerM(a, a - 5/2, x)
```

```
ans =
(2*x^(a - 2)*exp(-x/2)*(2*a^2 - 7*a + x^2/2 - ...
x*(2*a - 3) + 6))/pochhammer(2*a - 4, 2)
```

Differentiate Whittaker M Function

Differentiate the expression involving the Whittaker M function:

```
syms a b z
diff(whittakerM(a,b,z), z)
```

```
ans =
(whittakerM(a + 1, b, z)*(a + b + 1/2))/z - ...
(a/z - 1/2)*whittakerM(a, b, z)
```

Compute Whittaker M Function for Matrix Input

Compute the Whittaker M function for the elements of matrix A:

```
syms x
A = [-1, x^2; 0, x];
whittakerM(-1/2, 0, A)

ans =
[ exp(-1/2)*1i, exp(x^2/2)*(x^2)^(1/2) ]
[ 0, x^(1/2)*exp(x/2) ]
```

Input Arguments**a — Input**

number | vector | matrix | array | symbolic number | symbolic variable | symbolic array | symbolic function | symbolic expression

Input, specified as a number, vector, matrix, or array, or a symbolic number, variable, array, function, or expression.

If **a** is a vector or matrix, `whittakerM` returns the beta function for each element of **a**.

b — Input

number | vector | matrix | array | symbolic number | symbolic variable | symbolic array | symbolic function | symbolic expression

Input, specified as a number, vector, matrix, or array, or a symbolic number, variable, array, function, or expression.

If **b** is a vector or matrix, `whittakerM` returns the beta function for each element of **b**.

z — Input

number | vector | matrix | array | symbolic number | symbolic variable | symbolic array | symbolic function | symbolic expression

Input, specified as a number, vector, matrix, or array, or a symbolic number, variable, array, function, or expression.

If **x** is a vector or matrix, `whittakerM` returns the beta function for each element of **z**.

More About**Whittaker M Function**

The Whittaker functions $M_{a,b}(z)$ and $W_{a,b}(z)$ are linearly independent solutions of this differential equation:

$$\frac{d^2 w}{dz^2} + \left(-\frac{1}{4} + \frac{a}{z} + \frac{1/4 - b^2}{z^2} \right) w = 0$$

The Whittaker M function is defined via the confluent hypergeometric functions:

$$M_{a,b}(z) = e^{-z/2} z^{b+1/2} M\left(b - a + \frac{1}{2}, 1 + 2b, z\right)$$

Tips

- All non-scalar arguments must have the same size. If one or two input arguments are non-scalar, then `whittakerM` expands the scalars into vectors or matrices of the same size as the non-scalar arguments, with all elements equal to the corresponding scalar.

References

- [1] Slater, L. J. "Confluent Hypergeometric Functions." *Handbook of Mathematical Functions with Formulas, Graphs, and Mathematical Tables*. (M. Abramowitz and I. A. Stegun, eds.). New York: Dover, 1972.

See Also

`hypergeom` | `kummerU` | `whittakerW`

Introduced in R2012a

whittakerW

Whittaker W function

Syntax

`whittakerW(a,b,z)`

Description

`whittakerW(a,b,z)` returns the value of the Whittaker W function on page 4-1448.

Examples

Compute Whittaker W Function for Numeric Input

Compute the Whittaker W function for these numbers. Because these numbers are not symbolic objects, you get floating-point results.

```
[whittakerW(1, 1, 1), whittakerW(-2, 1, 3/2 + 2*i),...
whittakerW(2, 2, 2), whittakerW(3, -0.3, 1/101)]
```

```
ans =
    1.1953          -0.0156 - 0.0225i    4.8616          -0.1692
```

Compute Whittaker W Function for Symbolic Input

Compute the Whittaker W function for the numbers converted to symbolic objects. For most symbolic (exact) numbers, `whittakerW` returns unresolved symbolic calls.

```
[whittakerW(sym(1), 1, 1), whittakerW(-2, sym(1), 3/2 + 2*i),...
whittakerW(2, 2, sym(2)), whittakerW(sym(3), -0.3, 1/101)]
```

```
ans =
[ whittakerW(1, 1, 1), whittakerW(-2, 1, 3/2 + 2i),
whittakerW(2, 2, 2), whittakerW(3, -3/10, 1/101)]
```

For symbolic variables and expressions, `whittakerW` also returns unresolved symbolic calls:

```
syms a b x y
[whittakerW(a, b, x), whittakerW(1, x, x^2),...
whittakerW(2, x, y), whittakerW(3, x + y, x*y)]
```

```
ans =
[ whittakerW(a, b, x), whittakerW(1, x, x^2),
whittakerW(2, x, y), whittakerW(3, x + y, x*y)]
```

Solve ODE for Whittaker Functions

Solve this second-order differential equation. The solutions are given in terms of the Whittaker functions.

```
syms a b w(z)
dsolve(diff(w, 2) + (-1/4 + a/z + (1/4 - b^2)/z^2)*w == 0)
```

```
ans =
C2*whittakerM(-a, -b, -z) + C3*whittakerW(-a, -b, -z)
```

Verify Whittaker Functions are Solution of ODE

Verify that the Whittaker W function is a valid solution of this differential equation:

```
syms a b z
isAlways(diff(whittakerW(a, b, z), z, 2) +...
(-1/4 + a/z + (1/4 - b^2)/z^2)*whittakerW(a, b, z) == 0)
```

```
ans =
    logical
     1
```

Verify that $\text{whittakerW}(-a, -b, -z)$ also is a valid solution of this differential equation:

```
syms a b z
isAlways(diff(whittakerW(-a, -b, -z), z, 2) +...
(-1/4 + a/z + (1/4 - b^2)/z^2)*whittakerW(-a, -b, -z) == 0)
```

```
ans =
    logical
     1
```

Compute Special Values of Whittaker W Function

The Whittaker W function has special values for some parameters:

```
whittakerW(sym(-3/2), 1/2, 0)
```

```
ans =
4/(3*pi^(1/2))
```

```
syms a b x
whittakerW(0, b, x)
```

```
ans =
(x^(b + 1/2)*besselk(b, x/2))/(x^b*pi^(1/2))
```

```
whittakerW(a, -a + 1/2, x)
```

```
ans =
x^(1 - a)*x^(2*a - 1)*exp(-x/2)
```

```
whittakerW(a - 1/2, a, x)
```

```
ans =
(x^(a + 1/2)*exp(-x/2)*exp(x)*igamma(2*a, x))/x^(2*a)
```

Differentiate Whittaker W Function

Differentiate the expression involving the Whittaker W function:

```
syms a b z
diff(whittakerW(a,b,z), z)
```

```
ans =
- (a/z - 1/2)*whittakerW(a, b, z) -...
whittakerW(a + 1, b, z)/z
```

Compute Whittaker W Function for Matrix Input

Compute the Whittaker W function for the elements of matrix A:

```
syms x
A = [-1, x^2; 0, x];
whittakerW(-1/2, 0, A)

ans =
[ -exp(-1/2)*(ei(1) + pi*1i)*1i,...
  exp(x^2)*exp(-x^2/2)*expint(x^2)*(x^2)^(1/2)]
[ 0,...
  x^(1/2)*exp(-x/2)*exp(x)*expint(x)]
```

Input Arguments

a — Input

number | vector | matrix | array | symbolic number | symbolic variable | symbolic array | symbolic function | symbolic expression

Input, specified as a number, vector, matrix, or array, or a symbolic number, variable, array, function, or expression.

If **a** is a vector or matrix, `whittakerW` returns the beta function for each element of **a**.

b — Input

number | vector | matrix | array | symbolic number | symbolic variable | symbolic array | symbolic function | symbolic expression

Input, specified as a number, vector, matrix, or array, or a symbolic number, variable, array, function, or expression.

If **b** is a vector or matrix, `whittakerW` returns the beta function for each element of **b**.

z — Input

number | vector | matrix | array | symbolic number | symbolic variable | symbolic array | symbolic function | symbolic expression

Input, specified as a number, vector, matrix, or array, or a symbolic number, variable, array, function, or expression.

If **x** is a vector or matrix, `whittakerW` returns the beta function for each element of **z**.

More About

Whittaker W Function

The Whittaker functions $M_{a,b}(z)$ and $W_{a,b}(z)$ are linearly independent solutions of this differential equation:

$$\frac{d^2 w}{dz^2} + \left(-\frac{1}{4} + \frac{a}{z} + \frac{1/4 - b^2}{z^2} \right) w = 0$$

The Whittaker W function is defined via the confluent hypergeometric functions:

$$W_{a,b}(z) = e^{-z/2} z^{b+1/2} U\left(b - a + \frac{1}{2}, 1 + 2b, z\right)$$

Tips

- All non-scalar arguments must have the same size. If one or two input arguments are non-scalar, then `whittakerW` expands the scalars into vectors or matrices of the same size as the non-scalar arguments, with all elements equal to the corresponding scalar.

References

- [1] Slater, L. J. "Confluent Hypergeometric Functions." *Handbook of Mathematical Functions with Formulas, Graphs, and Mathematical Tables*. (M. Abramowitz and I. A. Stegun, eds.). New York: Dover, 1972.

See Also

`hypergeom` | `kummerU` | `whittakerM`

Introduced in R2012a

wrightOmega

Wright omega function

Syntax

```
wrightOmega(x)
```

Description

`wrightOmega(x)` computes the Wright omega function on page 4-1452 of `x`. If `z` is a matrix, `wrightOmega` acts elementwise on `z`.

Examples

Compute Wright Omega Function of Numeric Inputs

Compute the Wright omega function for these numbers. Because these numbers are not symbolic objects, you get floating-point results:

```
wrightOmega(1/2)
```

```
ans =  
    0.7662
```

```
wrightOmega(pi)
```

```
ans =  
    2.3061wrightOmega(-1+i*pi)
```

```
ans =  
    -1.0000 + 0.0000i
```

Compute Wright Omega Function of Symbolic Numbers

Compute the Wright omega function for the numbers converted to symbolic objects. For most symbolic (exact) numbers, `wrightOmega` returns unresolved symbolic calls:

```
wrightOmega(sym(1/2))
```

```
ans =  
wrightOmega(1/2)
```

```
wrightOmega(sym(pi))
```

```
ans =  
wrightOmega(pi)
```

For some exact numbers, `wrightOmega` has special values:

```
wrightOmega(-1+i*sym(pi))
```

```
ans =  
    -1
```

Compute Wright Omega Function of Symbolic Expression

Compute the Wright omega function for x and $\sin(x) + x*\exp(x)$. For symbolic variables and expressions, `wrightOmega` returns unresolved symbolic calls:

```
syms x
wrightOmega(x)
wrightOmega(sin(x) + x*exp(x))
```

```
ans =
wrightOmega(x)
```

```
ans =
wrightOmega(sin(x) + x*exp(x))
```

Compute Derivative of Wright Omega Function

Now compute the derivatives of these expressions:

```
diff(wrightOmega(x), x, 2)
diff(wrightOmega(sin(x) + x*exp(x)), x)
```

```
ans =
wrightOmega(x)/(wrightOmega(x) + 1)^2 - ...
wrightOmega(x)^2/(wrightOmega(x) + 1)^3
```

```
ans =
(wrightOmega(sin(x) + x*exp(x))*(cos(x) + ...
exp(x) + x*exp(x)))/(wrightOmega(sin(x) + x*exp(x)) + 1)
```

Compute Wright Omega Function for Matrix Input

Compute the Wright omega function for elements of matrix M and vector V :

```
M = [0 pi; 1/3 -pi];
V = sym([0; -1+i*pi]);
wrightOmega(M)
wrightOmega(V)
```

```
ans =
    0.5671    2.3061
    0.6959    0.0415
```

```
ans =
  lambertw(0, 1)
          -1
```

Input Arguments

x — Input

number | vector | matrix | array | symbolic number | symbolic variable | symbolic array | symbolic function | symbolic expression

Input, specified as a number, vector, matrix, or array, or a symbolic number, variable, array, function, or expression.

More About

Wright omega Function

The Wright omega function is defined in terms of the Lambert W function:

$$\omega(x) = W\left[\frac{\operatorname{Im}(x) - \pi}{2\pi}\right](e^x)$$

The Wright omega function $\omega(x)$ is a solution of the equation $Y + \log(Y) = X$.

References

- [1] Corless, R. M. and D. J. Jeffrey. "The Wright omega Function." *Artificial Intelligence, Automated Reasoning, and Symbolic Computation* (J. Calmet, B. Benhamou, O. Caprotti, L. Henocque, and V. Sorge, eds.). Berlin: Springer-Verlag, 2002, pp. 76-89.

See Also

`lambertW` | `log`

Introduced in R2011b

writeAnimation

Save animation as video file

Syntax

```
writeAnimation(filename)
writeAnimation(fig, filename)
writeAnimation( ____, Name, Value)
```

```
writeAnimation(vidObj)
writeAnimation(fig, vidObj)
```

Description

`writeAnimation(filename)` writes animation objects in the current figure to a GIF or AVI video file. The animation objects must be created using the `fanimator` function. The extension of `filename` sets the video format, and must be either `'.gif'` or `'.avi'`.

- If you do not specify the file extension, then `writeAnimation` chooses the `'.avi'` extension by default.
- If you specify any other file extension, such as `'.mp4'` or `'.mpg'`, then `writeAnimation` returns an error message.

`writeAnimation(fig, filename)` writes animation objects in the figure `fig` to a GIF or AVI video file.

`writeAnimation(____, Name, Value)` writes animation objects with the specified `Name, Value` pair arguments. Use this option with any of the input argument combinations in the previous syntaxes. You can set the name-value pair settings to specify the properties of a GIF or AVI video file.

`writeAnimation(vidObj)` writes animation objects in the current figure to a `VideoWriter` object. This syntax provides the option to save animation objects in another video file format, such as `'MPEG-4'` or `'Uncompressed AVI'`.

`writeAnimation(fig, vidObj)` writes animation objects in the figure `fig` to a `VideoWriter` object.

If you save an animation as a `VideoWriter` object, then the properties of the output video file follow the properties of the `VideoWriter` object.

Examples

Save Animation of Moving Circle as GIF File

Create a moving circle animation object and save it as a GIF file.

Create two symbolic variables, `t` and `x`. The variable `t` defines the time parameter of the animation. Use `t` to set the center of the circle at $(t, 1)$ and `x` to parameterize the perimeter of the circle within

the range $[-\pi, \pi]$. Create the circle animation object using `f animator`. Set the x-axis and y-axis to be equal length.

```
syms t x
f animator(@fplot,cos(x)+t,sin(x)+1,[-pi pi])
axis equal
```

Enter the command `playAnimation` to play the animation. Save the animation as a GIF video file named `'wheel.gif'`.

```
writeAnimation('wheel.gif')
```

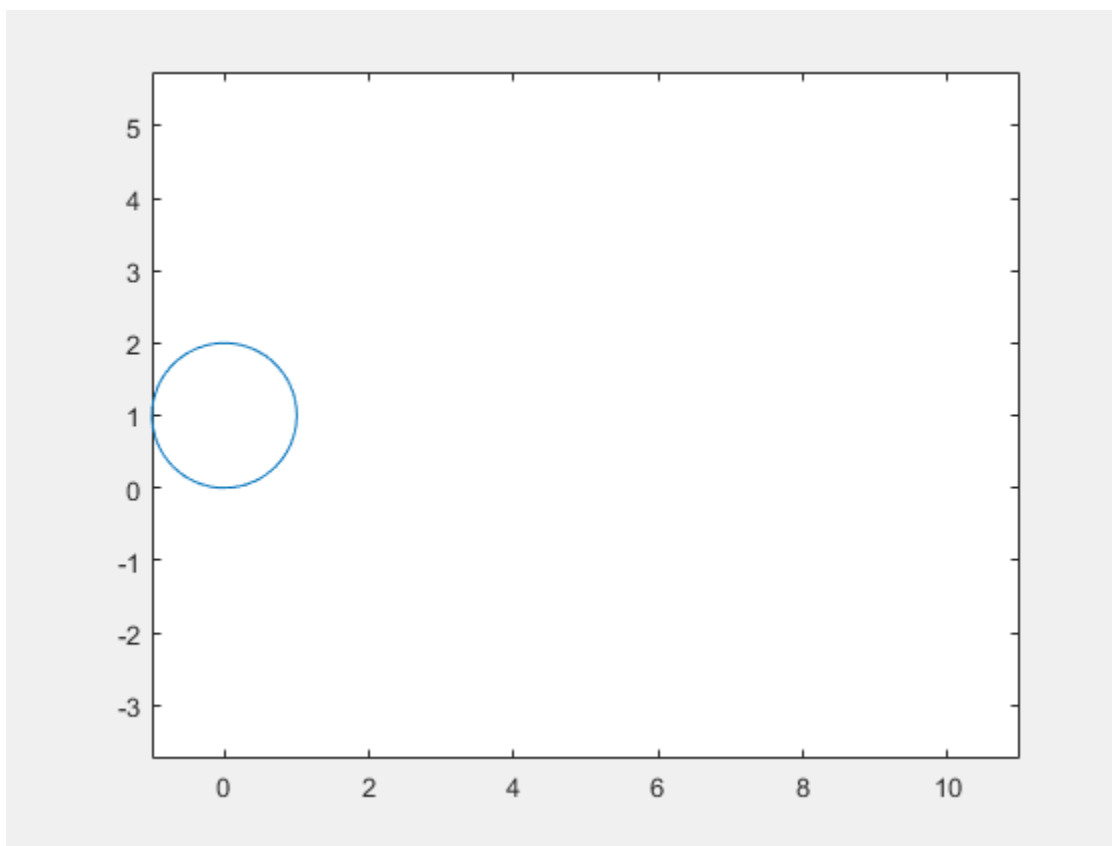

Save Animation of Moving Circle as MPEG-4 File

Create a moving circle animation object and save it as an MPEG-4 file.

First, create two symbolic variables, `t` and `x`. The variable `t` defines the time parameter of the animation. Use `t` to set the center of the circle at $(t, 1)$ and `x` to parameterize the perimeter of the circle within the range $[-\pi, \pi]$. Create the circle animation object using `f animator`. Set the x-axis and y-axis to be equal length.

```
syms t x
f animator(@fplot,cos(x)+t,sin(x)+1,[-pi pi])
axis equal
```

Enter the command `playAnimation` to play the animation.

Next, save the animation as an MPEG-4 file. Create a video object that saves to a file named 'myFile' by using the `VideoWriter` function. Specify the video file format as 'MPEG-4'. Open the video file, use `writeAnimation` to save the circle animation object, and close the video file.

```
vidObj = VideoWriter('myFile','MPEG-4');
open(vidObj)
writeAnimation(vidObj)
close(vidObj)
```

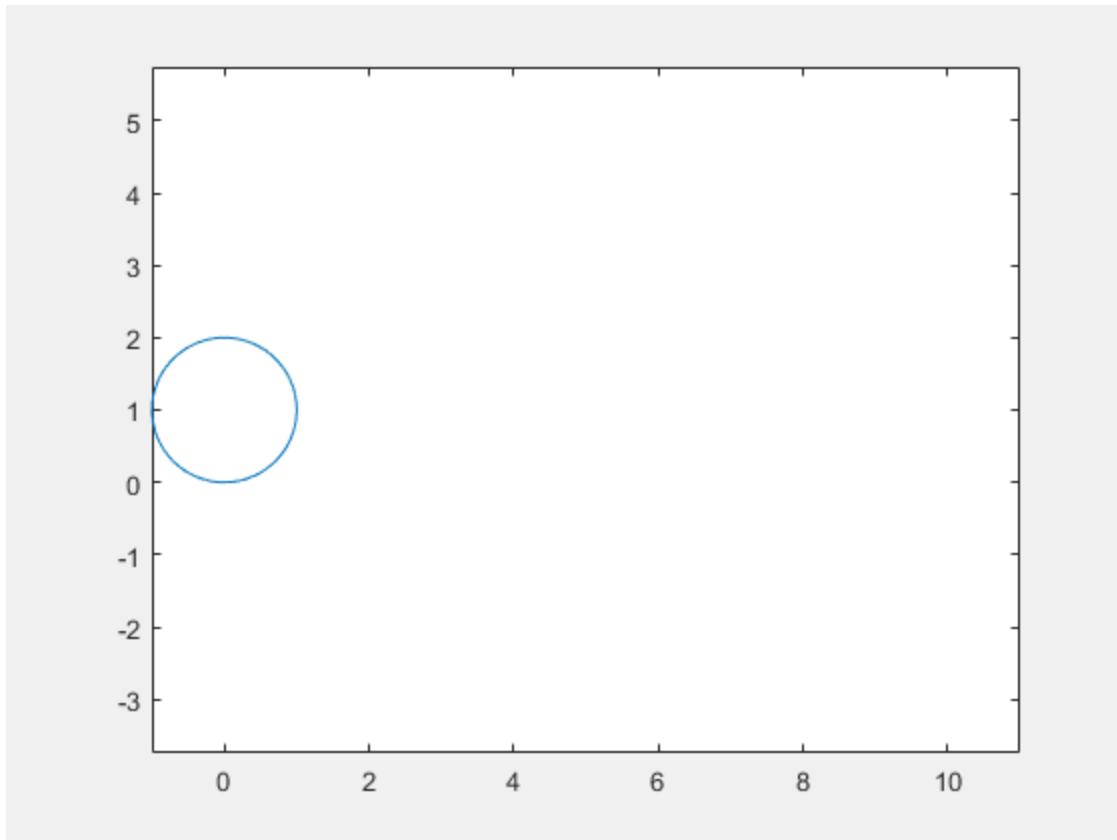

Save Animation as Looping GIF File

Create a circle animation object and save it as a GIF file that plays a specified number of loops.

First, create two symbolic variables, `t` and `x`. The variable `t` defines the time parameter of the animation. Create a figure window for the animation.

```
syms t x
fig = figure;
```

Create the circle animation object using `f Animator`. Use `t` to set the center of the circle at $(t, 1)$ and `x` to parameterize the perimeter of the circle within the range $[-\pi, \pi]$. Set the x-axis and y-axis to be equal length.

```
syms t x
f Animator(@fplot,cos(x)+t,sin(x)+1,[-pi pi])
axis equal
```

Enter the command `playAnimation` to play the animation.

Next, save the animation in the figure `fig` as a GIF file named `'loop.gif'` by using the `writeAnimation` function. The `writeAnimation` function always plays the animation once in a MATLAB figure window before saving the animation. When saving the animation as a GIF file, the created GIF file plays the animation once and repeats the number of loops as specified. For this example, set `'LoopCount'` to 1. The GIF file plays the animation twice.

```
writeAnimation(fig,'loop.gif','LoopCount',1)
```

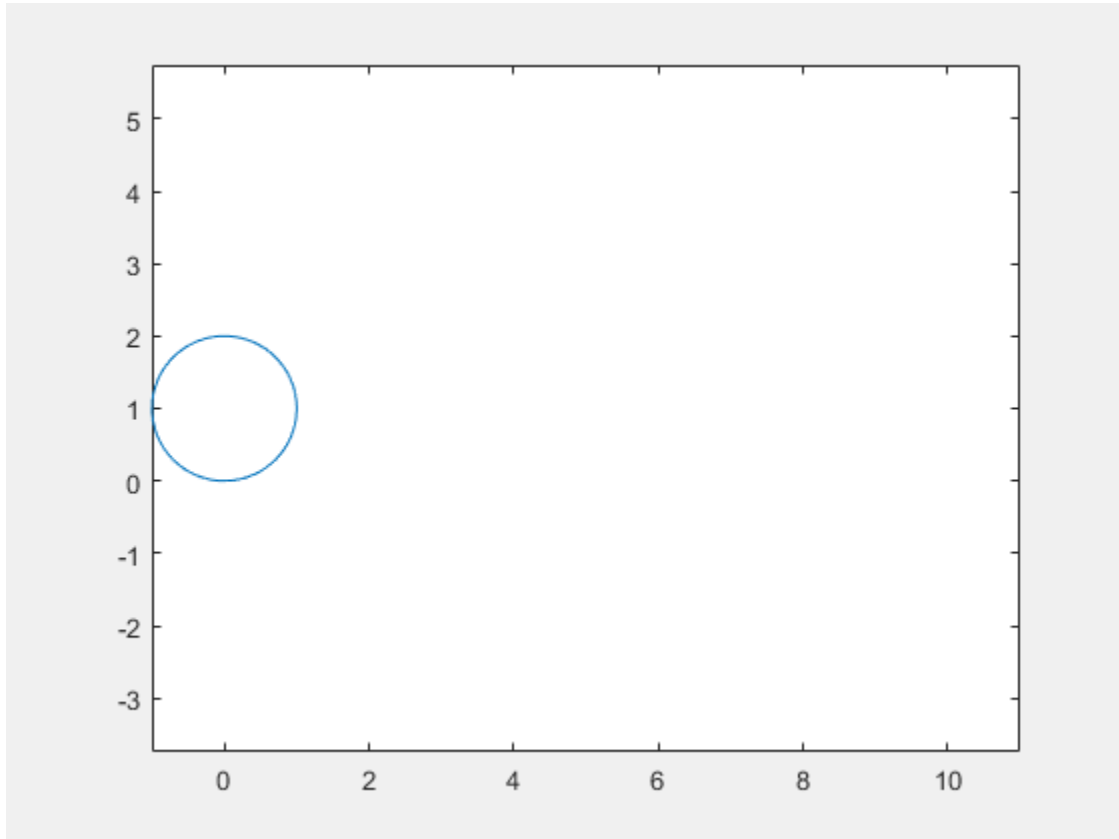

Note that to properly show the number of loops in a GIF video file, you must open the file in an application with GIF decoder.

Input Arguments

filename — Video filename

string | character vector

Video filename, specified as a string scalar or character vector. The extension of filename sets the video format, and must be either `'.gif'` or `'.avi'`. You must have permission to write the file.

- If you do not specify the file extension, then `writeAnimation` uses `'.avi'` by default.
- If filename already exists, then `writeAnimation` overwrites the file.
- If filename does not include a full path, then the function saves the animation to the current folder.

vidObj — Video object

VideoWriter object

Video object, specified as a VideoWriter object. The VideoWriter object provides the option to control the output video format when you save animation objects. For more information about VideoWriter object in MATLAB, see VideoWriter.

fig — Target figure

Figure object

Target figure, specified as a Figure object. For more information about Figure objects, see figure.

Name-Value Pair Arguments

Specify optional comma-separated pairs of Name, Value arguments. Name is the argument name and Value is the corresponding value. Name must appear inside quotes. You can specify several name and value pair arguments in any order as Name1, Value1, ..., NameN, ValueN.

Example: 'FrameRate', 15, 'LoopCount', 2

AnimationRange — Range of animation time parameter

[0 10] (default) | two-element row vector

Range of the animation time parameter, specified as a two-element row vector. The two elements must be real values that are increasing.

Example: [-2 4.5]

FrameRate — Frame rate

10 (default) | positive value

Frame rate, specified as a positive value. The frame rate defines the number of frames per unit time when you write animation objects to a video file.

Example: 30

Backwards — Backward option

logical 0 (false) (default) | logical value

Backward option, specified as a logical value (boolean). If you specify true, then the function saves the animation backwards or in reverse order.

Example: true

LoopCount — Animation loop count

0 (default) | nonnegative integer (from 0 to 65535) | Inf

Animation loop count, specified as a nonnegative integer (from 0 to 65535) or Inf. This value sets the number of repeated animation loops in a GIF file. Setting this value has no effect if you use a video file format other than GIF.

- If you use the default value of 0, then the GIF file plays the animation once.
- If you set 'LoopCount' to an integer n , then the GIF file plays the animation once plus n repeats (a total of $n+1$ times).
- To repeat the animation infinitely, use the Inf value.

Example: 1

See Also

VideoWriter | animationToFrame | f animator | playAnimation | rewindAnimation

Introduced in R2019a

xor

Logical XOR for symbolic expressions

Syntax

`xor(A,B)`

Description

`xor(A,B)` represents the logical exclusive disjunction. `xor(A,B)` is true when either A or B is true. If both A and B are true or false, `xor(A,B)` is false.

Examples

Set and Evaluate Condition

Combine two symbolic inequalities into a logical expression using `xor`.

```
syms x
range = xor(x > -10, x < 10);
```

Replace variable `x` with 11 and 0. If you replace `x` with 11, then inequality `x > -10` is valid and `x < 10` is invalid. If you replace `x` with 0, both inequalities are valid. Note that `subs` only substitutes the numeric values into the inequalities. It does not evaluate the inequalities to logical 1 or 0.

```
x1 = subs(range,x,11)
x2 = subs(range,x,0)
```

```
x1 =
-10 < 11 xor 11 < 10
```

```
x2 =
-10 < 0 xor 0 < 10
```

To evaluate these inequalities to logical 1 or 0, use `isAlways`. If only one inequality is valid, the expression with `xor` evaluates to logical 1. If both inequalities are valid, the expression with `xor` evaluates to logical 0.

```
isAlways(x1)
isAlways(x2)
```

```
ans =
    logical
     1
```

```
ans =
    logical
     0
```

Note that `simplify` does not simplify these logical expressions to logical 1 or 0. Instead, `simplify` returns *symbolic* constants `symtrue` or `symfalse`.

```
s1 = simplify(x1)
s2 = simplify(x2)

s1 =
symtrue

s2 =
symfalse
```

Convert symbolic `symtrue` or `symfalse` to logical values using `logical`.

```
logical(s1)
logical(s2)

ans =
    logical
     1

ans =
    logical
     0
```

Input Arguments

A, B — Operands

symbolic equations | symbolic inequalities | symbolic expressions | symbolic arrays

Operands, specified as symbolic equations, inequalities, expressions, or arrays. Inputs **A** and **B** must either be the same size or have sizes that are compatible (for example, **A** is an **M**-by-**N** matrix and **B** is a scalar or 1-by-**N** row vector). For more information, see “Compatible Array Sizes for Basic Operations” (MATLAB).

Tips

- If you call `simplify` for a logical expression containing symbolic subexpressions, you can get the symbolic constants `symtrue` and `symfalse`. These two constants are not the same as logical 1 (true) and logical 0 (false). To convert symbolic `symtrue` and `symfalse` to logical values, use `logical`.
- `assume` and `assumeAlso` do not accept assumptions that contain `xor`.

Compatibility Considerations

Implicit expansion change affects arguments for operators

Behavior changed in R2016b

Starting in R2016b with the addition of implicit expansion, some combinations of arguments for basic operations that previously returned errors now produce results. For example, you previously could not add a row and a column vector, but those operands are now valid for addition. In other words, an expression like `[1 2] + [1; 2]` previously returned a size mismatch error, but now it executes.

If your code uses element-wise operators and relies on the errors that MATLAB previously returned for mismatched sizes, particularly within a `try/catch` block, then your code might no longer catch those errors.

For more information on the required input sizes for basic array operations, see “Compatible Array Sizes for Basic Operations” (MATLAB).

See Also

`all` | `and` | `any` | `isAlways` | `not` | `or`

Introduced in R2012a

zeta

Riemann zeta function

Syntax

```
zeta(z)
zeta(n,z)
```

Description

`zeta(z)` evaluates the Riemann zeta function at the elements of `z`, where `z` is a numeric or symbolic input.

`zeta(n,z)` returns the `n`th derivative of `zeta(z)`.

Examples

Find Riemann Zeta Function for Numeric and Symbolic Inputs

Find the Riemann zeta function for numeric inputs.

```
zeta([0.7 i 4 11/3])
ans =
-2.7784 + 0.0000i  0.0033 - 0.4182i  1.0823 + 0.0000i  1.1094 + 0.0000i
```

Find the Riemann zeta function symbolically by converting the inputs to symbolic objects using `sym`. The `zeta` function returns exact results.

```
zeta(sym([0.7 i 4 11/3]))
ans =
[ zeta(7/10), zeta(1i), pi^4/90, zeta(11/3)]
```

`zeta` returns unevaluated function calls for symbolic inputs that do not have results implemented. The implemented results are listed in “Algorithms” on page 4-1465.

Find the Riemann zeta function for a matrix of symbolic expressions.

```
syms x y
Z = zeta([x sin(x); 8*x/11 x + y])
Z =
[ zeta(x), zeta(sin(x))]
[ zeta((8*x)/11), zeta(x + y)]
```

Find Riemann Zeta Function for Large Inputs

For values of $|z| > 1000$, `zeta(z)` might return an unevaluated function call. Use `expand` to force `zeta` to evaluate the function call.

```
zeta(sym(1002))
expand(zeta(sym(1002)))
```

```
ans =
zeta(1002)
ans =
(1087503...312*pi^1002)/15156647...375
```

Differentiate Riemann Zeta Function

Find the third derivative of the Riemann zeta function at point x .

```
syms x
expr = zeta(3,x)
```

```
expr =
zeta(3, x)
```

Find the third derivative at $x = 4$ by substituting 4 for x using `subs`.

```
expr = subs(expr,x,4)
```

```
expr =
zeta(3, 4)
```

Evaluate `expr` using `vpa`.

```
expr = vpa(expr)
```

```
expr =
-0.07264084989132137196244616781177
```

Plot Zeros of Riemann Zeta Function

Zeros of the Riemann Zeta function $\zeta(x+iy)$ are found along the line $x = 1/2$. Plot the absolute value of the function along this line for $0 < y < 30$ to view the first three zeros.

```
syms y
fplot(abs(zeta(1/2+1i*y)),[0 30])
grid on
```

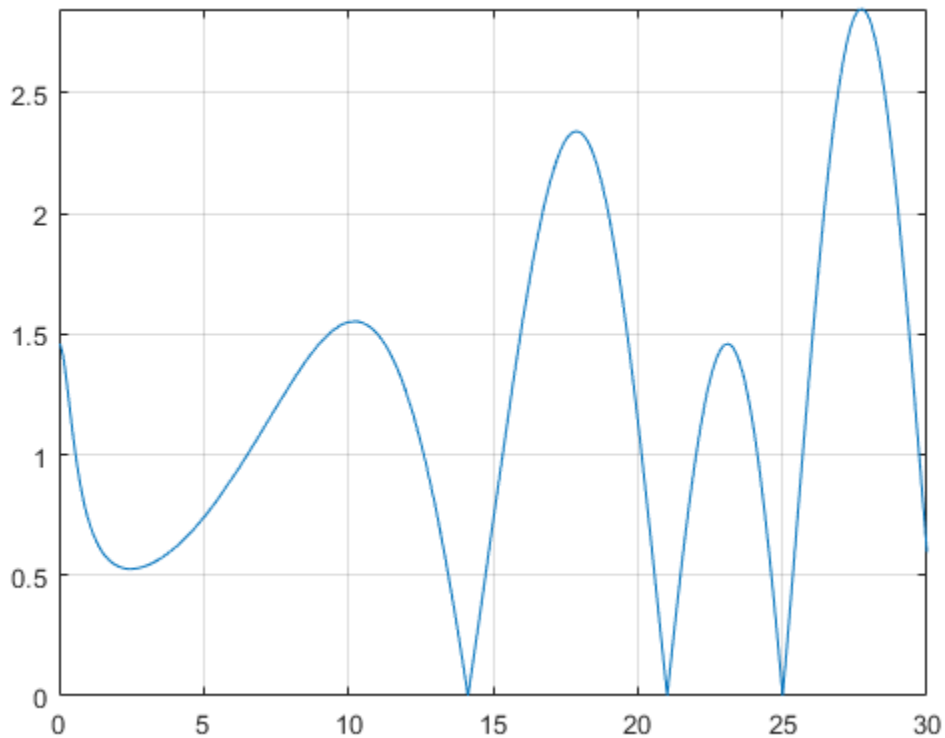

Input Arguments

z – Input

number | vector | matrix | multidimensional array | symbolic number | symbolic variable | symbolic vector | symbolic matrix | symbolic multidimensional array | symbolic function | symbolic expression

Input, specified as a number, vector, matrix or multidimensional array, or a symbolic number, variable, vector, matrix, multidimensional array, function or expression.

n – Order of derivative

nonnegative integer

Order of derivative, specified as a nonnegative integer.

More About

Riemann Zeta Function

The Riemann zeta function is defined by

$$\zeta(z) = \sum_{k=1}^{\infty} \frac{1}{k^z}$$

The series converges only if the real part of z is greater than 1. The definition of the function is extended to the entire complex plane, except for a simple pole $z = 1$, by analytic continuation.

Tips

- Floating point evaluation is slow for large values of n .

Algorithms

The following exact values are implemented.

- $\zeta(0) = -\frac{1}{2}$
- $\zeta(1, 0) = -\frac{\log(\pi)}{2} - \frac{\log(2)}{2}$
- $\zeta(\infty) = 1$
- If $z < 0$ and z is an even integer, $\zeta(z) = 0$.
- If $z < 0$ and z is an odd integer

$$\zeta(z) = -\frac{\text{bernoulli}(1-z)}{1-z}$$

For $z < -1000$, `zeta(z)` returns an unevaluated function call. To force evaluation, use `expand(zeta(z))`.

- If $z > 0$ and z is an even integer

$$\zeta(z) = \frac{(2\pi)^z |\text{bernoulli}(z)|}{2z!}$$

For $z > 1000$, `zeta(z)` returns an unevaluated function call. To force evaluation, use `expand(zeta(z))`.

- If $n > 0$, $\zeta(n, \infty) = 0$.
- If the argument does not evaluate to a listed special value, `zeta` returns the symbolic function call.

See Also

`bernoulli` | `gamma` | `hurwitzZeta` | `psi`

Introduced before R2006a

ztrans

Z-transform

Syntax

```
ztrans(f)
ztrans(f,transVar)
ztrans(f,var,transVar)
```

Description

`ztrans(f)` finds the “Z-Transform” on page 4-1469 of `f`. By default, the independent variable is `n` and the transformation variable is `z`. If `f` does not contain `n`, `ztrans` uses `symvar`.

`ztrans(f,transVar)` uses the transformation variable `transVar` instead of `z`.

`ztrans(f,var,transVar)` uses the independent variable `var` and transformation variable `transVar` instead of `n` and `z`, respectively.

Examples

Z-Transform of Symbolic Expression

Compute the Z-transform of $\sin(n)$. By default, the transform is in terms of `z`.

```
syms n
f = sin(n);
ztrans(f)

ans =
(z*sin(1))/(z^2 - 2*cos(1)*z + 1)
```

Specify Independent Variable and Transformation Variable

Compute the Z-transform of $\exp(m+n)$. By default, the independent variable is `n` and the transformation variable is `z`.

```
syms m n
f = exp(m+n);
ztrans(f)

ans =
(z*exp(m))/(z - exp(1))
```

Specify the transformation variable as `y`. If you specify only one variable, that variable is the transformation variable. The independent variable is still `n`.

```
syms y
ztrans(f,y)
```



```
ans =
(y*exp(m))/(y - exp(1))
```

Specify both the independent and transformation variables as m and y in the second and third arguments, respectively.

```
ztrans(f,m,y)
```

```
ans =
(y*exp(n))/(y - exp(1))
```

Z-Transforms Involving Heaviside Function and Binomial Coefficient

Compute the Z-transform of the Heaviside function and the binomial coefficient.

```
syms n z
ztrans heaviside(n-3),n,z)
```

```
ans =
(1/(z - 1) + 1/2)/z^3
```

```
ztrans(nchoosek(n,2))
```

```
ans =
z/(z - 1)^3
```

Z-Transform of Array Inputs

Find the Z-transform of the matrix M . Specify the independent and transformation variables for each matrix entry by using matrices of the same size. When the arguments are nonscalars, `ztrans` acts on them element-wise.

```
syms a b c d w x y z
M = [exp(x) 1; sin(y) i*z];
vars = [w x; y z];
transVars = [a b; c d];
ztrans(M,vars,transVars)
```

```
ans =
[ (a*exp(x))/(a - 1), b/(b - 1)]
[ (c*sin(1))/(c^2 - 2*cos(1)*c + 1), (d*1i)/(d - 1)^2]
```

If `ztrans` is called with both scalar and nonscalar arguments, then it expands the scalars to match the nonscalars by using scalar expansion. Nonscalar arguments must be the same size.

```
syms w x y z a b c d
ztrans(x,vars,transVars)
```

```
ans =
[ (a*x)/(a - 1), b/(b - 1)^2]
[ (c*x)/(c - 1), (d*x)/(d - 1)]
```

Z-Transform of Symbolic Function

Compute the Z-transform of symbolic functions. When the first argument contains symbolic functions, then the second argument must be a scalar.

```
syms f1(x) f2(x) a b
f1(x) = exp(x);
f2(x) = x;
ztrans([f1 f2],x,[a b])

ans =
[ a/(a - exp(1)), b/(b - 1)^2]
```

If Z-Transform Cannot Be Found

If `ztrans` cannot transform the input then it returns an unevaluated call.

```
syms f(n)
f(n) = 1/n;
F = ztrans(f,n,z)

F =
ztrans(1/n, n, z)
```

Return the original expression by using `iztrans`.

```
iztrans(F,z,n)

ans =
1/n
```

Input Arguments

f — Input

symbolic expression | symbolic function | symbolic vector | symbolic matrix

Input, specified as a symbolic expression, function, vector, or matrix.

var — Independent variable

n (default) | symbolic variable

Independent variable, specified as a symbolic variable. This variable is often called the "discrete time variable". If you do not specify the variable, then `ztrans` uses `n`. If `f` does not contain `n`, then `ztrans` uses the function `symvar`.

transVar — Transformation variable

z (default) | symbolic variable | symbolic expression | symbolic vector | symbolic matrix

Transformation variable, specified as a symbolic variable, expression, vector, or matrix. This variable is often called the "complex frequency variable." By default, `ztrans` uses `z`. If `z` is the independent variable of `f`, then `ztrans` uses `w`.

More About

Z-Transform

The Z-transform $F = F(z)$ of the expression $f = f(n)$ with respect to the variable n at the point z is

$$F(z) = \sum_{n=0}^{\infty} \frac{f(n)}{z^n}.$$

Tips

- If any argument is an array, then `ztrans` acts element-wise on all elements of the array.
- If the first argument contains a symbolic function, then the second argument must be a scalar.
- To compute the inverse Z-transform, use `iztrans`.

See Also

`fourier` | `ifourier` | `ilaplace` | `iztrans` | `kronckerDelta` | `laplace`

Topics

“Solve Difference Equations Using Z-Transform” on page 2-224

Introduced before R2006a

